

USR-N668 User Manual

File Version: V1.0.4



Contents

USR-N668 User Manual	1
Features.....	4
1. Get Start	5
1.1. Hardware Test.....	5
1.2. NTE Network Test Environment.....	7
1.3. Default parameter test	7
2. Product overview.....	9
2.1. Basic parameters	10
3. Hardware Design	11
3.1. Hardware Dimensions.....	11
3.2. Pin definition	11
3.2.2. Pin definition	14
3.2.3. LED Indicator.....	14
4. Product Functions.....	15
4.1. Basic Functions	15
4.1.1. IP address / Subnet mask / Gateway.....	15
4.1.2. DNS.....	17
4.1.3. VPN-PPTP.....	17
4.1.4. VPN-GRE	18
4.1.5. Network diagnosis	19
4.1.6. Restore factory settings	20
4.1.7. Web Server	20
4.1.8. Firmware upgrade.....	21
4.2. Transtransmission function.....	22
4.2.1. TCP Client.....	22
4.2.2. TCP Server.....	24
4.2.3. UDP Client.....	26
4.2.4. UDP Server.....	28
4.2.5. Httpd Client.....	29
4.2.6. SSL Client	31
4.2.7. V-COM	32
4.3. Serial port Functions.....	33
4.3.1. Serial port framing mechanism.....	33
4.3.2. RFC2217-like	33
4.4. Characteristic function.....	34
4.4.1. Socket B	34
4.4.2. Heartbeat Packet Function	35
4.4.3. Registration package	36
4.4.4. Modbus TCP.....	37
4.4.5. No data reconnection	38
4.4.6. DDNS.....	39
4.4.7. Remote management and remote monitoring	39

4.4.8. Scheduled task.....	40
5.Parameter setting	41
5.1. Network protocol settings parameters	41
5.1.1. Software setting parameters.....	41
5.1.2. Setting protocol settings parameters.....	43
5.2. Web settings parameters.....	43
5.3. AT command.....	46
5.3.1. AT command.....	46
5.3.2. Error code.....	47
6.Contact Us	48
7.Disclaimer.....	48
8.Update History.....	48

Features

- Two 10/100Mbps Ethernet port, support Auto-MDI/MDIX.
- 8 serial ports all support RS232/RS485/RS422.
- Support Static IP or DHCP.
- TCP Server, TCP Client, UDP Client, UDP Server, HTTPD Client .
- 8 serial ports all support two sockets ,and all can send data to two different servers when work as Client.
- It works as TCP client, supports to 16(max) TCP Client.
- Keep-alive & Registration-package.
- Modbus TCP to Modbus RTU.
- User-defined overtime Reload (no data reload)and overtime connection.
- The modifiable , one and only MAC.
- DNS domain name resolution ,user-defined DNS server address.
- Remote monitoring and remote firmware upgrading.
- Network time synchronization +RTC real time clock.
- User-defined Task Scheduler.
- Supports web server configuration.
- Supports V-COM.
- Reload by hardware and software.
- Run across gateways, switches and routers.
- Work in LAN or external network.

1. Get Start

Product link:

<http://usriot.com/products/8-ports-serial-to-ethernet-converter.html>

Model: USR-N668

USR-N668

Share to:

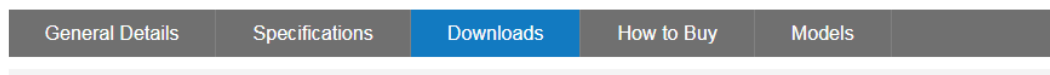

Figure 1 Download Page

If you have any question, please submit it back to customer center: <http://h.usriot.com>

1.1. Hardware Test

1.1.1. Hardware Preparation

You need:

1. USR-N668 for one;
2. Power cord (85V~265V) for one;
3. Female to female serial cable for one;
4. DB9-M to RJ45 for one;
5. Network line for two;
6. PC (with RS232, or USB to 232)

1.1.2. Hardware Connection

For test the communication conversion between serial port and network, you should connect the USR-N668 to PC with serial cable (or USB to serial cable), connect the Ethernet port of USR-N668 and PC with network. Make sure the connection is correct, then power on.

- ALL the connecting lines form USR IOT;

- The test only for RS232, factory default setting for RS232;
- Check the dial up settings window ,make sure USR-N668 work at correct pattern.(See the details in Hardware introduce->Dial up)

RS232/485/422 Smart switch



Figure 1. RS232/485/422 smart switch

- N668 serial port 1->network->DB9-M to RJ45->mother to mother serial cable->PC serial port



Figure 2. serial port connection between N668 and PC

- The above is the hardware connection diagram of RS232 for transparent transmission. when use RS485/RS422,you can connect the corresponding signal line.(see the details in Hardware introduce->Serial port pin definition)
- Note: the standard configuration of DB9-M to RJ 45 is only one, if you need more, you need separate

purchase
The overall hardware connection and data flow are as follows,

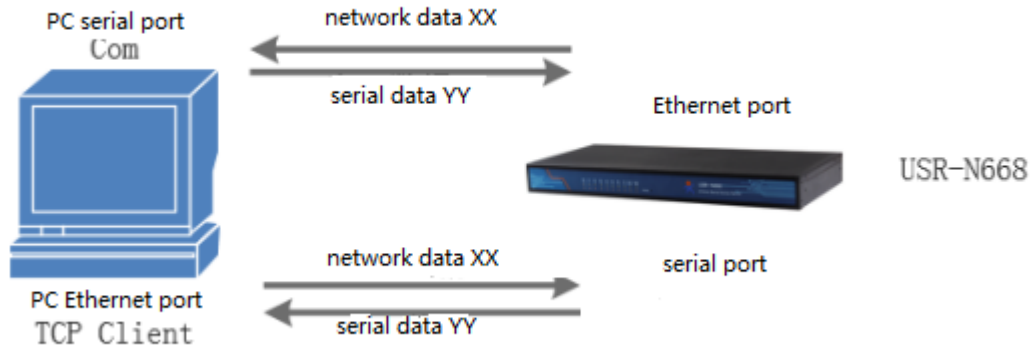

Figure 3. data flow

1.2.NTE Network Test Environment

Before the network test, you should:

- 1) Close the firewall of the computer (usually found in the control panel)and anti-virus software;
- 2) Close the network card which is not related to this test, only one local connection is reserved;
- 3) For servers to connect directly to PC, a static IP (address in the same network segment with USR-N668) must be set to the PC (e.g.192.168.0.201).

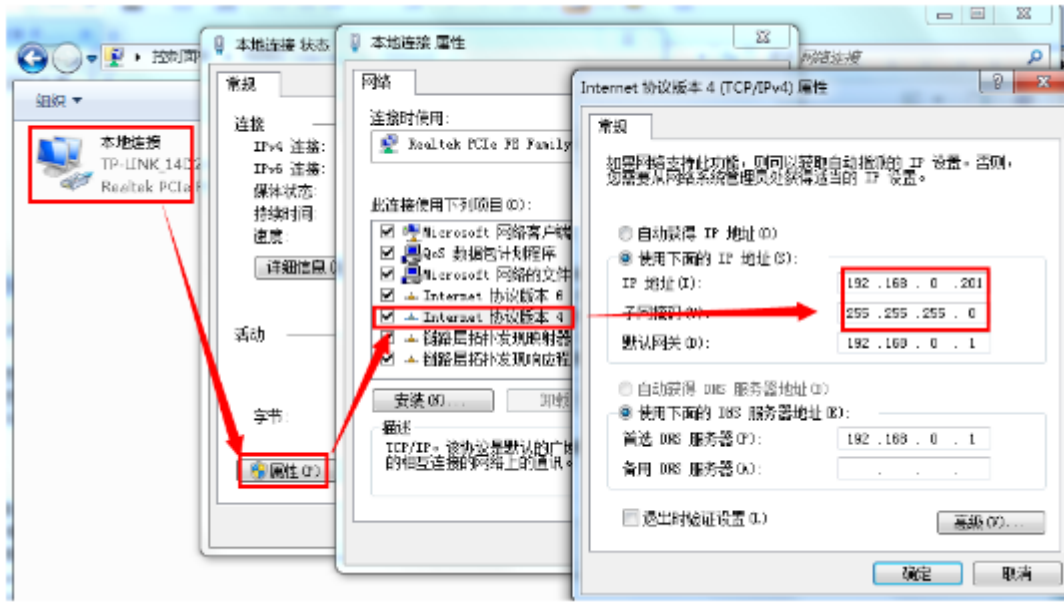

Figure 4. PC local connection settings

1.3. Default parameter test

Table 1 default parameters

Item	Content
User name	admin
Password	admin
IP address	192.168.0.7
Subnet mask	255.255.255.0
Default gateway	192.168.0.1
Default mode of operation	TCP Server
Default target port	20001~20008
Default local port	20001~20008
Default target IP	192.168.0.201
Serial baud rate	115200
Serial port parameters	None/8/1

After confirmation, You can carry out the bidirectional between the serial port and the Ethernet port.

Communication procedures are as follows:

- 1) Open the testing software"USR-TCP232-Test.exe", connected hardware;
- 2) The default mode of operation is TCP Server, first port serial port monitor 20001 port. So choose TCP client mode at the network setup end of the software,IP:192.168.0.7,target port 20001,then click the connect. The serial baud rate is 115200, The serial port parameter is set to None/8/1,chick open.
- 3) Send data for test, the data flow form serial port to Net is: PC serial port->668 serial port->668 Ethernet port->PC network; the data flow form Net to serial port is: PC network->668 Ethernet port->668 serial port->PC serial port. The specific demo is shown below.

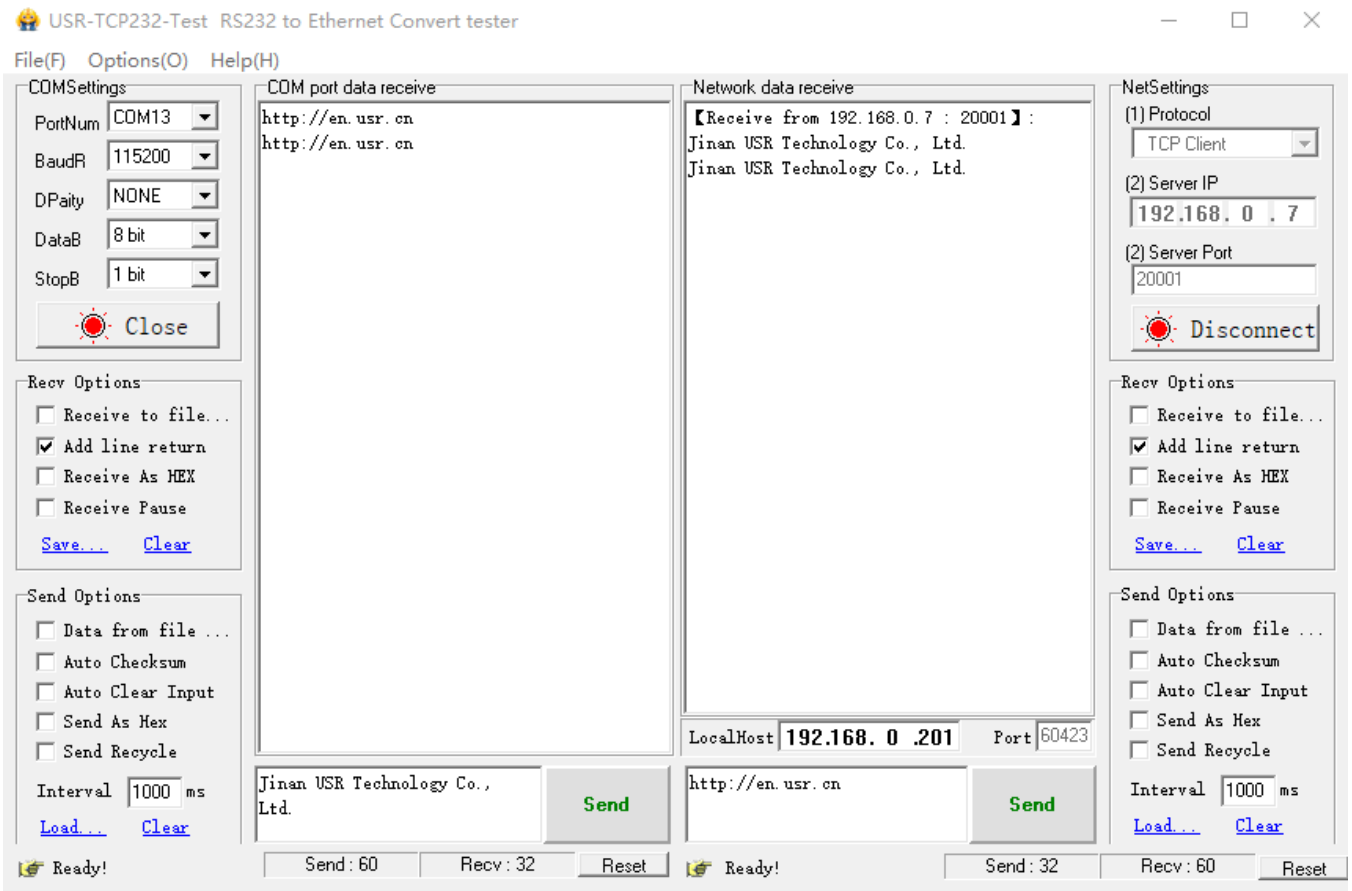

Figure 5. data transmission test

The USR-TCP232-Test.exe download links:

<https://www.usriot.com/support/downloads/usr-tcp-test-testing-software.html>

2. Product overview



Figure 6. USR-N668 hardware interface

2.1. Basic parameters

2.2.

Table 2 Electrical parameters

classification	parameter	numerical
Hardware parameters	Working voltage	AC 85~265V, 50/60Hz
	Power Consumption	1.6W
	Ethernet Port	RJ45、10/100Mbps
	Number of Ethernet port	2
	Serial port format	RJ45
	Number of serial port	8*RS232/RS485/RS422
	Serial baud rate	300-115.2K(bps)
Software parameters	Network protocol	IP、TCP/UDP、ARP、ICMP、IPV4、HTTP、SSL
	IP	Static IP、DHCP
	Domain name resolution	Support, customize DNS server address
	User configuration	Software configuration, Web page configuration, AT instruction configuration
	Simple pass through mode	TCP Server/TCP Client/SSL Client UDP Server/UDP Client/Http Client
	Class RFC2217	Support
	Network cache	10kbyte
	Serial port cache	10kbyte
	Average transmission delay	>=50ms
	Software kit	V-COM,setup software,test program
	Packaging mechanism	50ms packing time, 1472 bytes packing length
	Certificate	CE/RoHs
Other	Reliability grade	EN61000-4-2(static electricity) Grade 4 EN61000-4-4(pulse group) Grade 4 EN61000-4-5(surge) Grade 3
	Shell protection	IP30
	Full-size	482*185*45 MM
	Work temperature	40~85℃
	Storage temperature	40~85℃
	Work humidity	5%~95%(Non condensation)
	Storage humidity	5%~95%(Non condensation)

3. Hardware Design

3.1. Hardware Dimensions

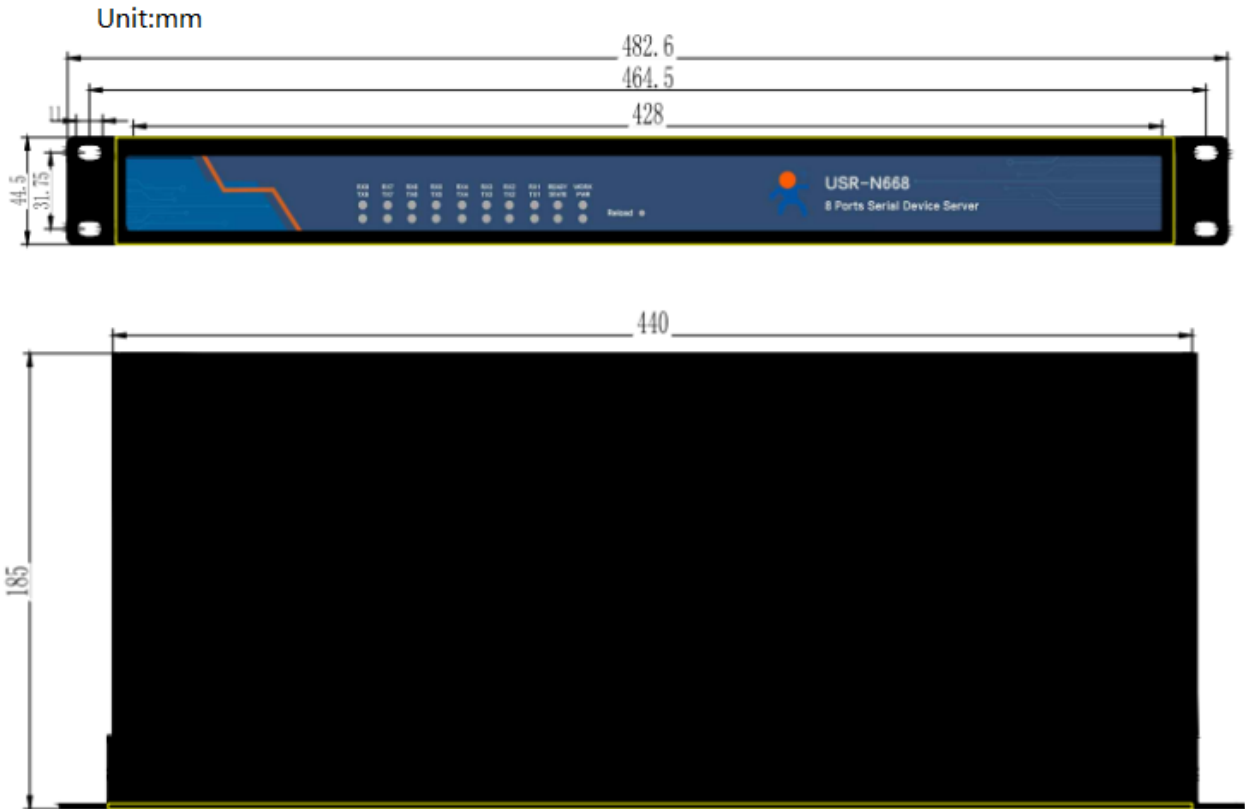

Figure 7 Hardware dimensions

3.2. Pin definition

3.2.1. Dial switch

On the back of the equipment, there is a dial up switch setting window. You need to use the cross flower screwdriver, remove the screws to see. The following is the setting of the code switch.

RS232/485/422 Smart switch



Figure 8. RS232/485/422 smart switch

A total of 16 (8 serial port * 2) dial code. The device has 8 serial ports and 2 dial numbers per route, as shown in the figure.



Figure 9. RS232 model



Figure 10. RS485 model



Figure 11. RS422 model

Table 3 Correspondence

communication mode	Dial switch(L to R)
232	0 0
485	1 1
422	1 0

Pay attention:

- The switch position is shown in the figure.
- The dialing sequence form L to R.
- Default is 232 mode,the dial switch is "0 0".

3.2.2. Pin definition

The serial port pin diagram is as follows (The hardware interface is RJ45).

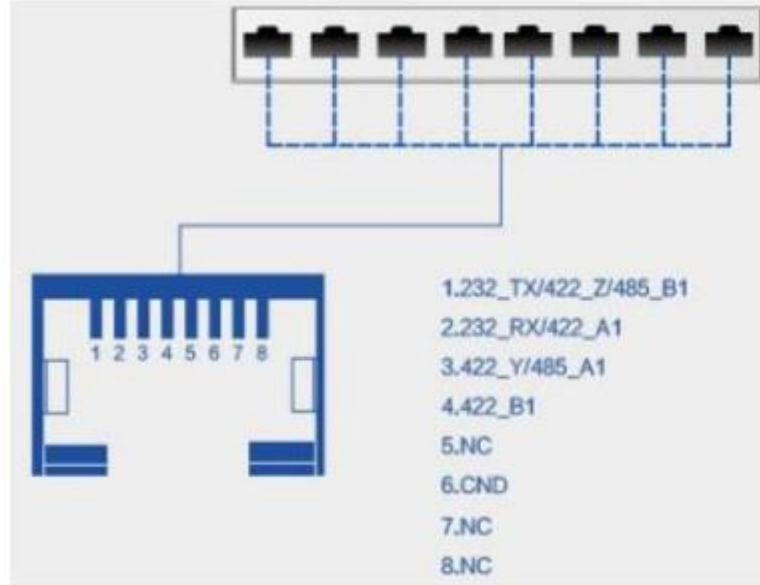

Figure 12. Serial line sequence

Table 4 Serial line sequence

Pin Number	Name	Function
1	232_TX/422_Z/485_B1	232 send;422 signal Z;485 signal B
2	232_RX/422_A1	232 receive;422 signal A
3	422_Y/485_A1	422 signal Y;485 signal A
4	422_B1	422 signal B
5	NC	
6	GND	232 signal GND
7	NC	
8	NC	

Pay attention:

- 232,485,422 can't work at one time;
- The position of the dialing switch must be correct.
- The hardware interface is RJ45, you need to use 8 core cable and crystal head to make communication cables.

3.2.3. LED Indicator

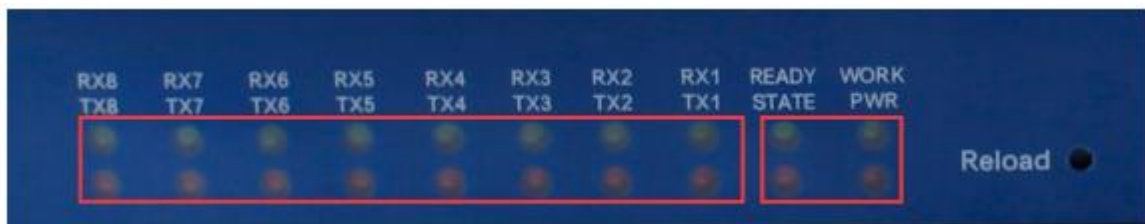

Figure 13. LED location

LED status reference table.

Table 5 LED indicator

Indicator	Function
PWR	Red/On: Power on
WORK	Green/ Flicker: Working
STATE	Red/ Undefined
READY	Green/On: working
TXN	Red/Flicker: Serial port sending data
RXN	Green/Flicker: Serial port receiving data

4. Product Functions

This chapter introduces the functions of USR-N668 as the following diagram shown, you can get an overall knowledge of it.

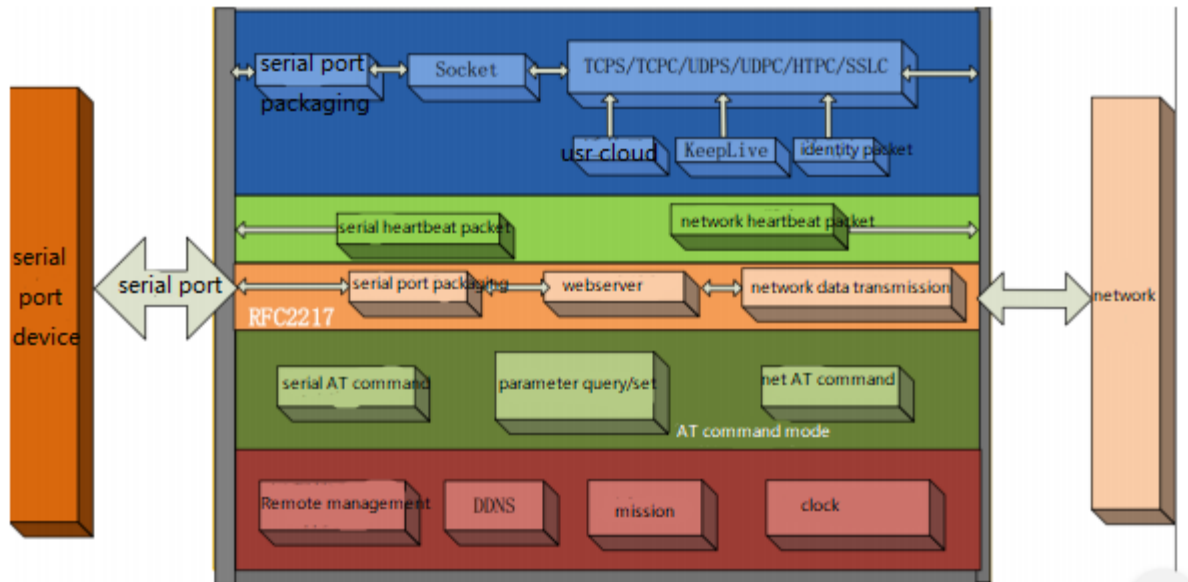

Figure 14 Product 668 Functions diagram

4.1. Basic Functions

4.1.1. IP address / Subnet mask / Gateway

There are two ways for module to get IP address: Static IP and DHCP.

IP Address

Protocol

IPv4 Address

IPv4 Netmask

IPv4 Gateway

Main DNS

Backup DNS

[Save&Apply](#)

Figure 15 IP address setup

Table 6 Station IP and DHCP

IP acquisition mode	Advantage
Static IP	Default setting of module is Static IP and default IP is 192.168.0.7. When user set module in Static IP mode, user need set IP, subnet mask and gateway and must pay attention to the relation among IP, subnet mask and gateway.
DHCP	Module in DHCP mode can dynamically get IP, Gateway, and DNS server address from Gateway Host. When user connect directly to PC, module can't be set in DHCP mode. Because common computer does not have the ability to assign IP addresses.

Subnet mask is mainly used to determine the IP address of the network number and host number, indicating the number of subnets, judging whether the module is in the subnet flag. Subnet Masks must be set, we usually use the C class subnet mask: 255.255.255.0, network number for the first 24 bits, host number for the last 8 bits, the number of subnets For the 255 module IP in 255 scopes, the module IP is considered in this subnet.

Gateway refers to the network number of the module where the current IP address is located. If you connect to devices such as routers when connecting to the outside network, the gateway is the router IP address, if set up incorrectly, you can't access the outside network correctly, if you do not connect to devices such as routers, you do not need to set up, the default can be.

Reference AT command

Table 7 Station IP /DHCP AT command

AT command	Describe

4.1.2. DNS

DNS server address , default master server 208.67.222.222, standby server 8.8.8.8.

DNS server address can be set, can achieve domain name resolution in the case of imperfect local domain name server, users can also set the address of a specific DNS server according to needs, 668 need domain name resolution will be set to the DNS server to submit a resolution request.

In the case of DHCP, the domain name server address is automatically acquired.

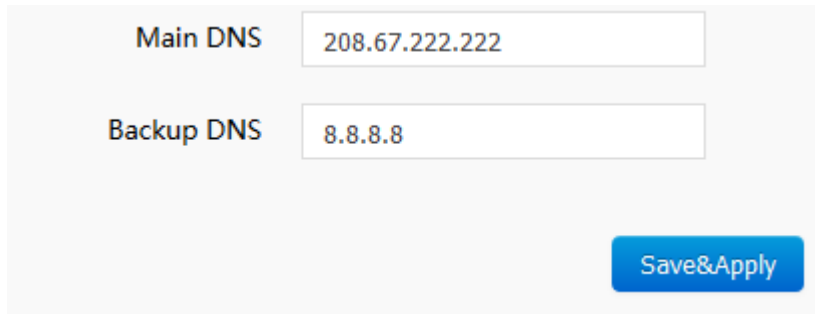

The screenshot shows a configuration interface for DNS servers. It features two input fields: 'Main DNS' with the value '208.67.222.222' and 'Backup DNS' with the value '8.8.8.8'. A blue 'Save&Apply' button is located at the bottom right of the form.

Figure 16 DNS server

Reference AT command

Table 8 DNS AT command

AT command	Describe
AT+DNS	Set and query DNS server

4.1.3. VPN-PPTP

Support the VPN link of PPTP protocol.

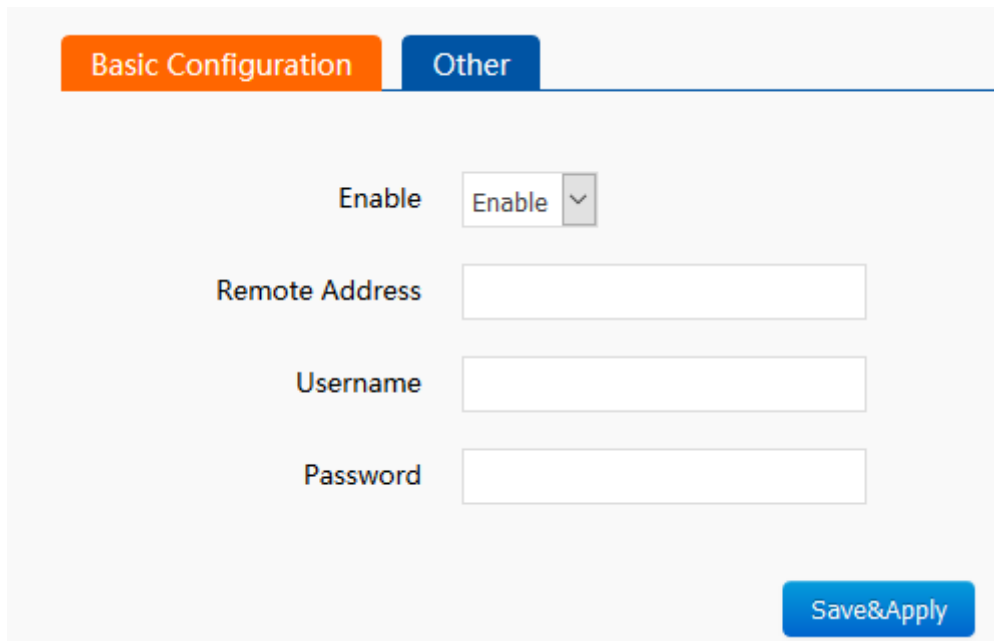

The screenshot shows a configuration interface for PPTP. It has two tabs: 'Basic Configuration' (selected) and 'Other'. Under 'Basic Configuration', there is an 'Enable' dropdown menu set to 'Enable'. Below it are three input fields for 'Remote Address', 'Username', and 'Password'. A blue 'Save&Apply' button is at the bottom right.

Figure 17 PPTP set

Remote address, user name, password are the basic parameters; there are encryption, authentication and other parameters can be set.

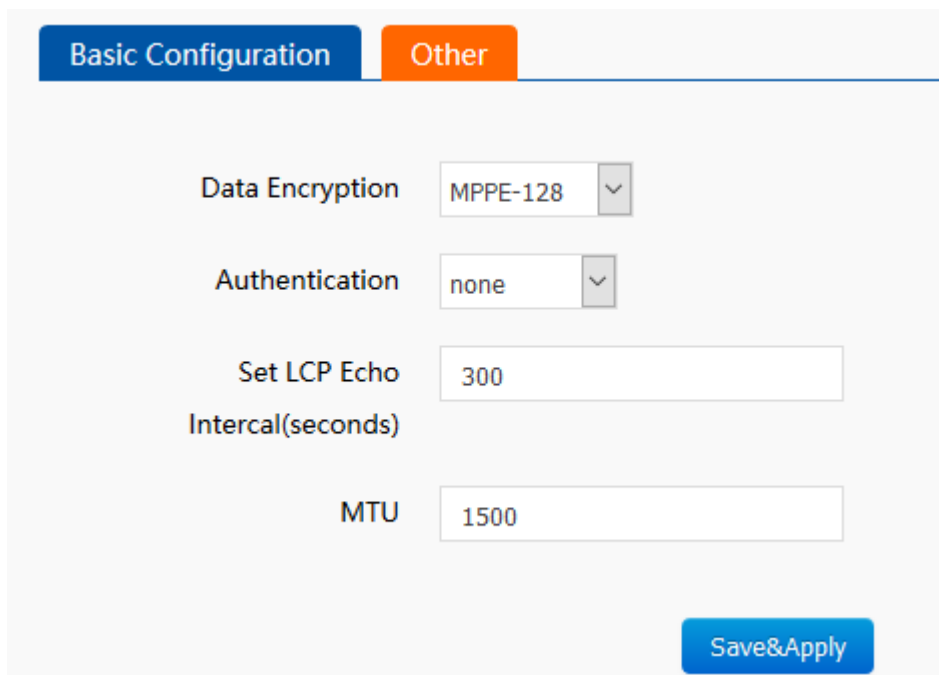

The screenshot shows a configuration interface with two tabs: 'Basic Configuration' (selected) and 'Other'. Under the 'Other' tab, there are four configuration items:

- Data Encryption:** A dropdown menu showing 'MPPE-128'.
- Authentication:** A dropdown menu showing 'none'.
- Set LCP Echo Intercal(seconds):** A text input field containing '300'.
- MTU:** A text input field containing '1500'.

A blue 'Save&Apply' button is located at the bottom right of the configuration area.

Figure 18 Data encryption

Data encryption: support MPPE, MPPE-128 and other encryption methods.

Authentication: support PAP, CHAP, MSCHAP, MSCHAPv2, etc.

LCP response interval: the default heartbeat interaction interval is 300 seconds.

MTU: maximum transmission unit, default 1500, can be reduced according to requirements.

4.1.4. VPN-GRE

Support VPN-GRE

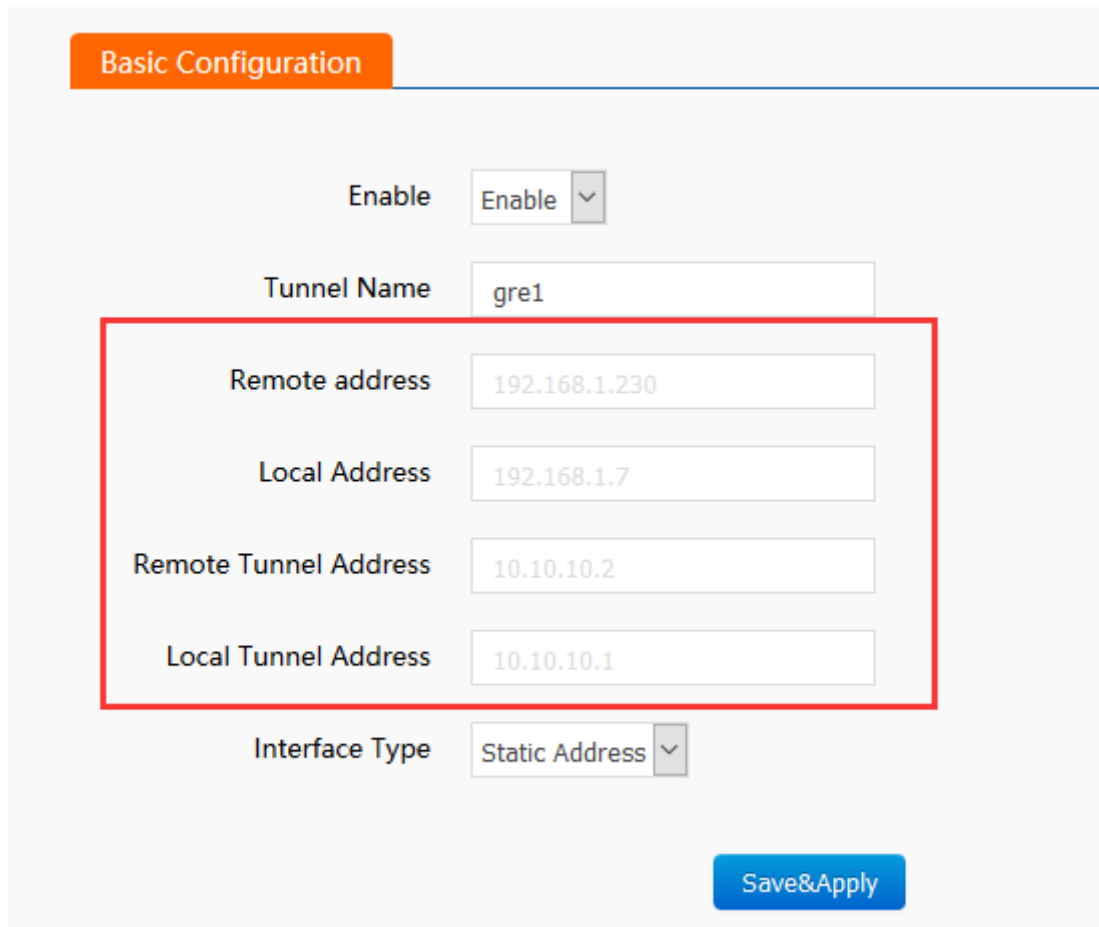

Basic Configuration

Enable

Tunnel Name

Remote address

Local Address

Remote Tunnel Address

Local Tunnel Address

Interface Type

Figure 19VPN-GRE

There are four main parameters. remote address, local address, remote tunnel address, and local tunnel address. After the GRE is established, the two sides can interoperate and visit each other on IP.

4.1.5. Network diagnosis

The network diagnostic function supports Ping instructions for testing the network link.

e.g.: ping www.baidu.com -w 3

-w indicates the duration of Ping.

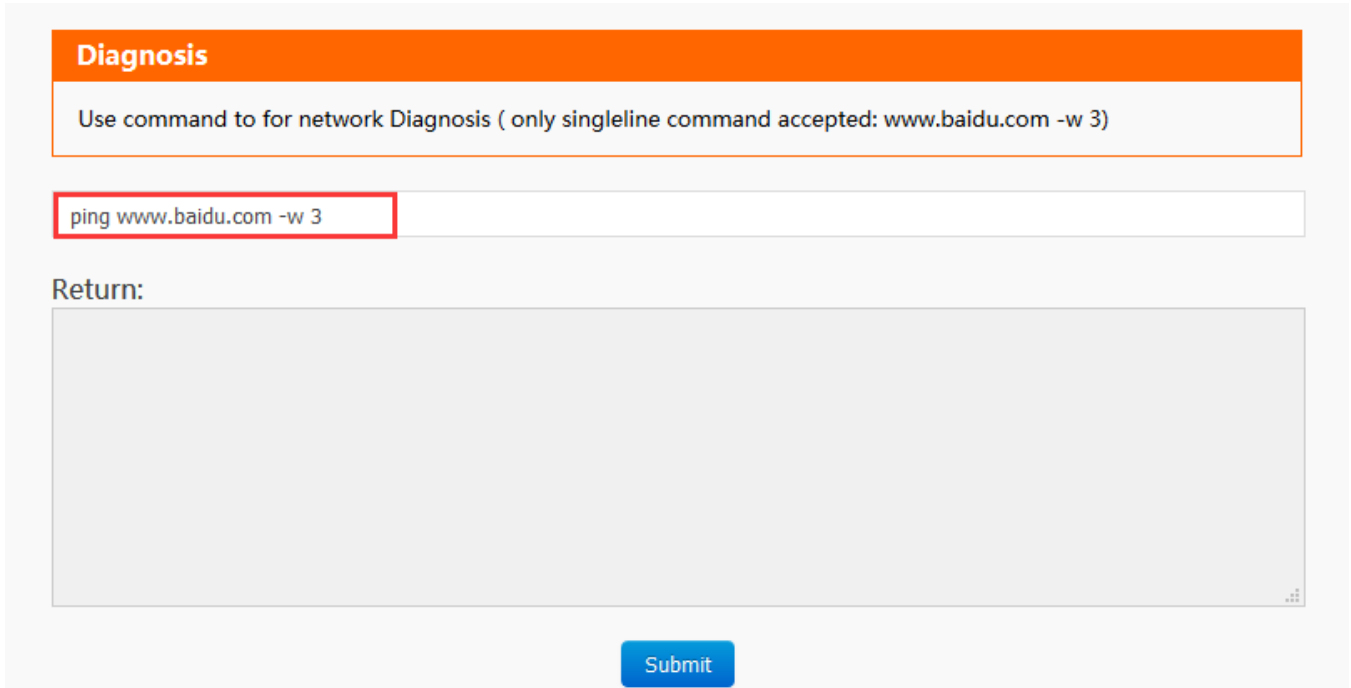

Figure 20 network diagnostic function

4.1.6. Restore factory settings

- 1) Hardware buttons: Press the Reload button between 5S and 15s to restore the factory settings , and no restore will be performed if less than 5S or more than 15s. When the module parameter is configured erroneously or if you forget to set the password, you can use the hardware to restore the factory settings.
- 2) Setting up software: setting up the factory's function by setting up the software.
- 3) AT instruction: enter AT instruction mode and resume factory by instruction AT+RELD.
- 4) Web page: restore the factory button.

4.1.7. Web Server

Built-in web server, users can set parameters through the web page and also can view the relevant state of the module. The default home page is the current status interface, which is refreshed every 5s, showing the working status of 668.

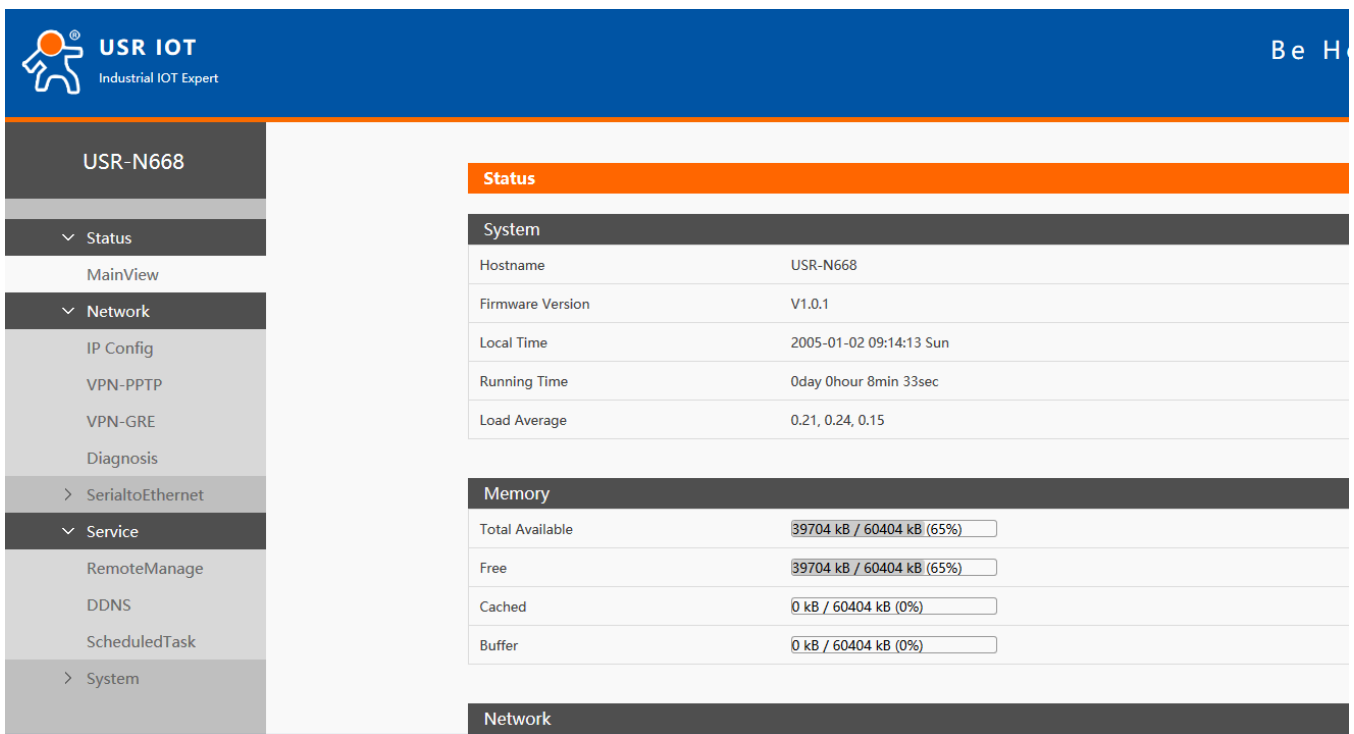

The screenshot shows the USR IOT web interface for the USR-N668 device. The left sidebar contains a navigation menu with the following items: Status, MainView, Network (IP Config, VPN-PPTP, VPN-GRE, Diagnosis), SerialtoEthernet, Service (RemoteManage, DDNS, ScheduledTask), and System. The main content area is titled "Status" and displays the following information:

System	
Hostname	USR-N668
Firmware Version	V1.0.1
Local Time	2005-01-02 09:14:13 Sun
Running Time	0day 0hour 8min 33sec
Load Average	0.21, 0.24, 0.15

Memory	
Total Available	39704 kB / 60404 kB (65%)
Free	39704 kB / 60404 kB (65%)
Cached	0 kB / 60404 kB (0%)
Buffer	0 kB / 60404 kB (0%)

The "Network" section is partially visible at the bottom of the screenshot.

Figure 21 668 working status

4.1.8. Firmware upgrade

The specific upgrading methods are as follows.

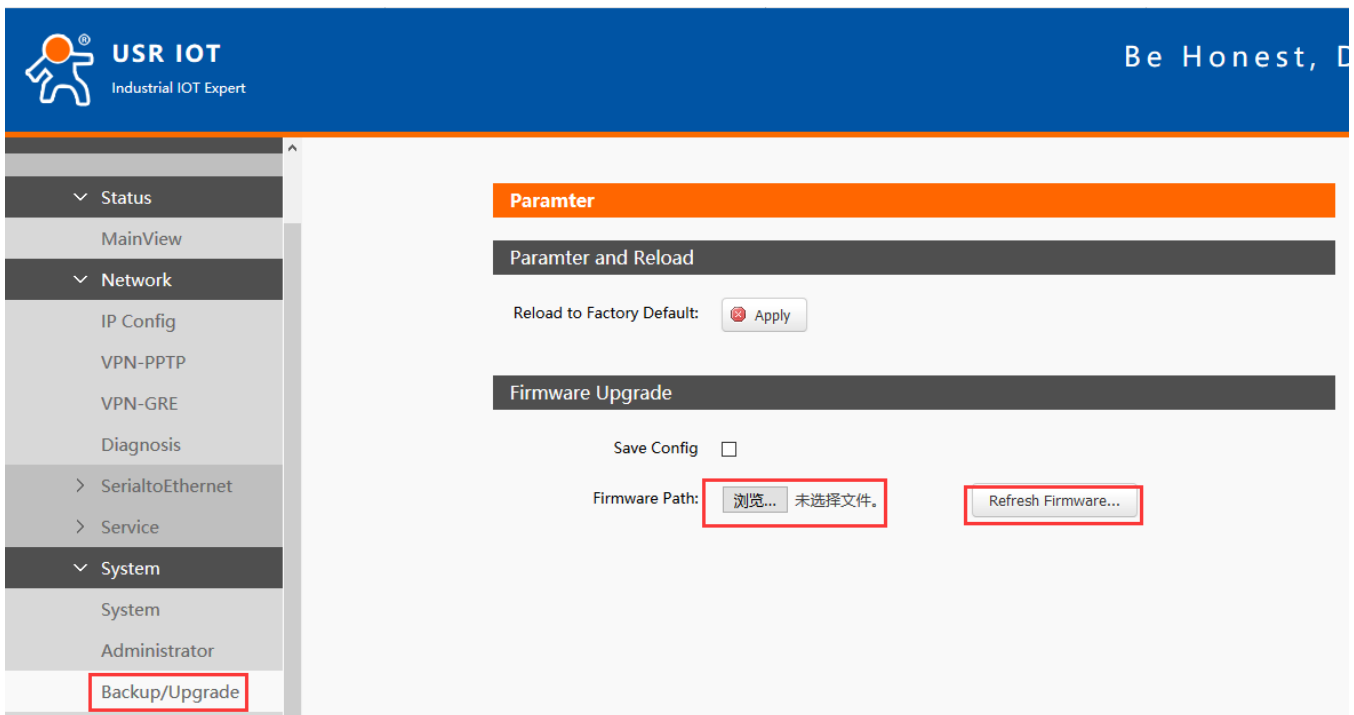

The screenshot shows the USR IOT web interface for the USR-N668 device, specifically the "Firmware Upgrade" configuration page. The left sidebar shows the navigation menu with "Backup/Upgrade" highlighted. The main content area is titled "Paramter" and contains the following sections:

- Paramter and Reload:** Includes a "Reload to Factory Default:" button with a red 'X' icon and an "Apply" button.
- Firmware Upgrade:** Includes a "Save Config" checkbox (unchecked) and a "Firmware Path:" field. The field contains a "浏览..." (Browse...) button and the text "未选择文件。" (No file selected.). A "Refresh Firmware..." button is also present.

Figure 22 668 firmware upgrade 1

Choose the firmware path.

Firmware Path: 未选择文件。

Figure 23 668 firmware upgrade 2

File transfer is finished, click confirm for firmware upgrade.

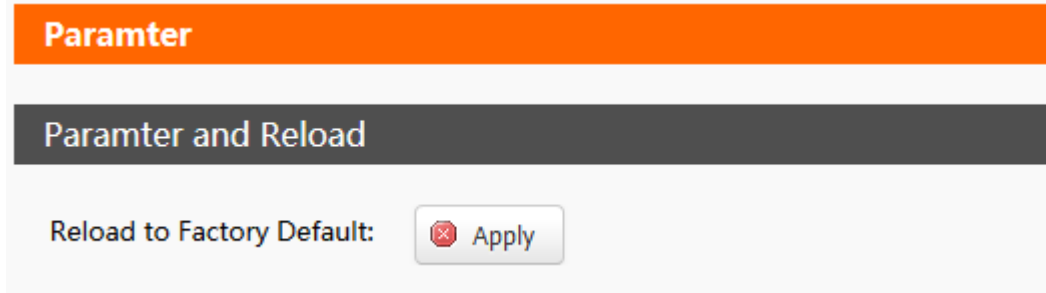

Figure 24 668 firmware upgrade 3

After waiting for 100 seconds, the firmware brush is finished, and you can login again.



Figure 25 668 firmware upgrade 4

Attention:

- No power failure during the process of firmware brush writing.
- The process of writing and restarting is expected to be 100 seconds (see page timing), and then the device can be revisited.
- You can choose whether to retain parameters, and don't retain them by default.
- The official firmware must be used.

4.2. Transtransmission function

668 Socket work mode: TCP Client, TCP Server, UDP Client, UDP Server, Httpd Client. SSL Client.

Reference AT command

Table 9 TCP Client AT command

AT command	Describe
AT+SOCK	Set up Socket work mode / target IP/ target port

4.2.1. TCP Client

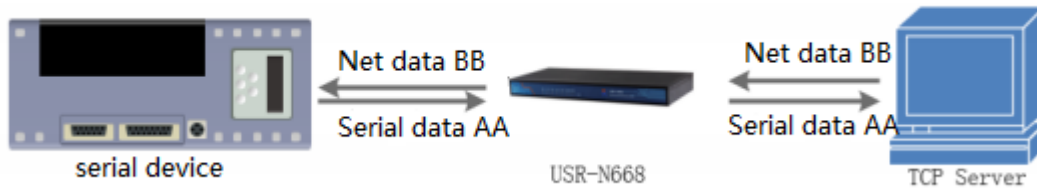

Figure 26 TCP Client work mode

- 1) TCP Client provides client connection for TCP network services. Initiatively connection requests to the server and establishes connections to achieve serial numbers interaction with server data. According to the relevant provisions of the TCP protocol, TCP Client is the difference between connection and disconnection, so as to ensure data reliable exchange. Usually used for data interaction between devices and servers, is the most commonly used network communication mode.
- 2) The pattern has the function of actively identifying connection anomalies. When the connection is established, several "Keep Alive" are sent after 60 seconds of no data for the first time .If the connection is abnormal interruption, it will be immediately detected, and prompted 668 to disconnect the original connection and reconnect (The formula is $60 + 5 * 3 = 75$ s).
- 3) This model supports synchronous baud rate function, USR-cloud function and short connection function.
- 4) In the same LAN, if 668 is set to static IP, keep 668 IP and gateway in the same network segment, and set gateway IP correctly, otherwise it will not be able to communicate properly.
- 5) When 668 work as TCP Client, you need to pay attention to target IP / domain name and target port number. If you connect a server across a public network, the server must has public network IP or domain name.
- 6) When 668 work as TCP Client, the local port NO. suggest to set to 0, so that 668 can access the server with random port number.
- 7) TCP Client communication examples
 - ① work mode :TCP Client, IP: 192.168.0.201, teleport: 20001 .Then save parameters and restart.

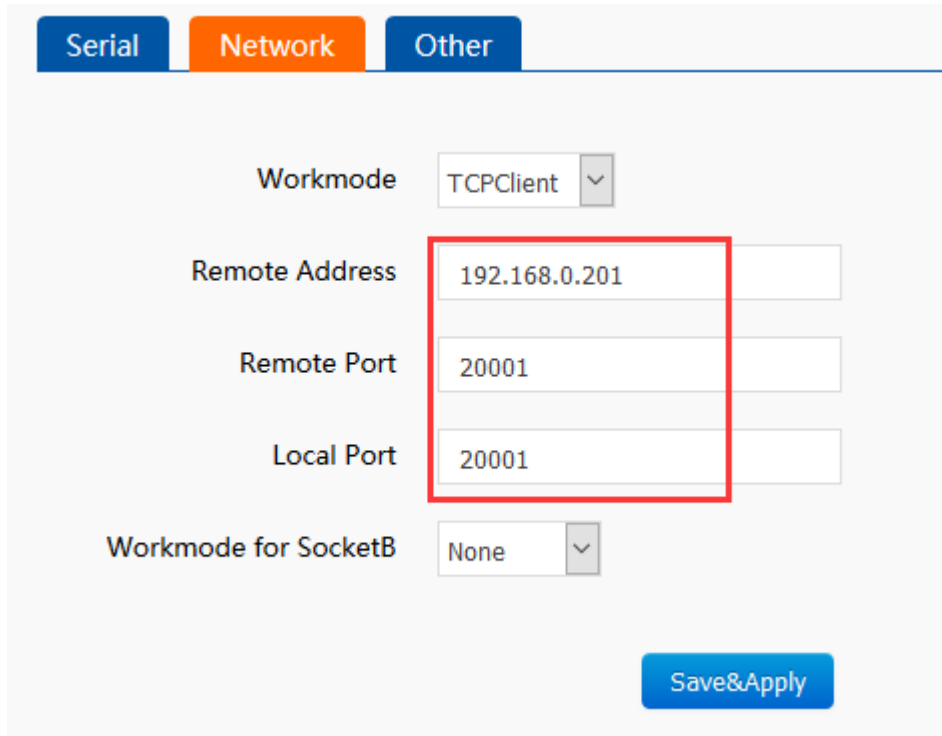

Figure 27 TCP Client web page setting

- ② "USR-TCP232-Test.exe" work as TCP Server, the local IP address is the IP address of PC, e.g. 192.168.0.201, listening port: 20001, then click listening. Software shows Connection objects: 192.168.0.7:20001. Open the serial port.
- ③ Click send, you can transmission data now.

Figure 28 TCP Client transmission test

4.2.2. TCP Server

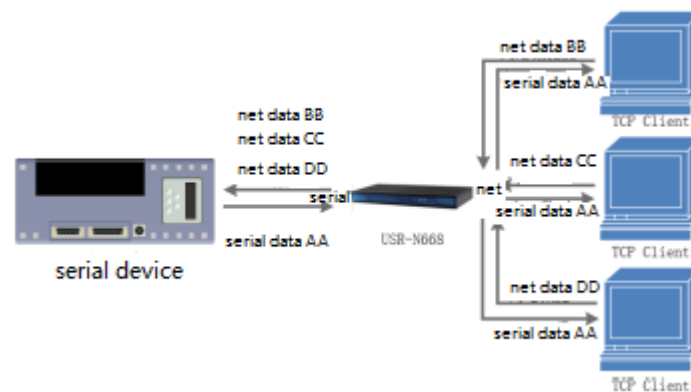
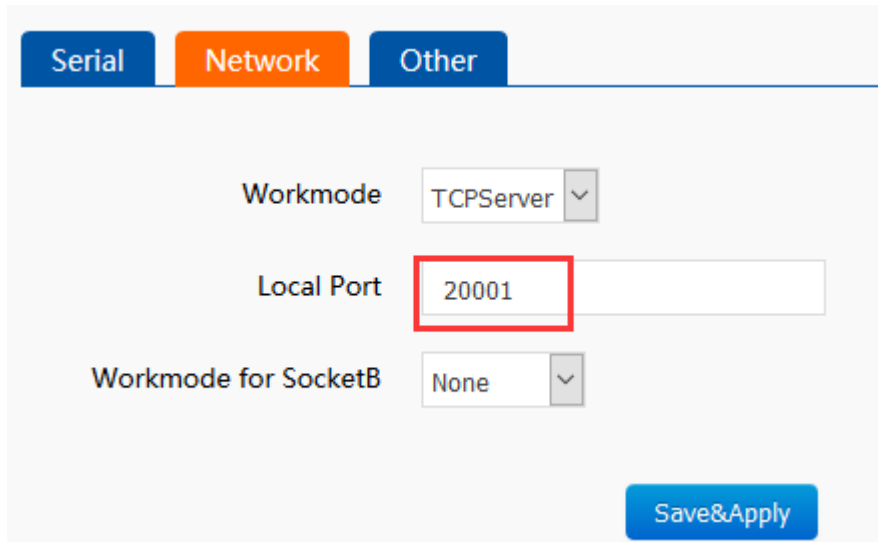

Figure 29 TCP Server

- 1) when 668 work as TCP Server, there are "Keep Alive" functions, for real-time monitoring.
- 2) Use for TCP client communication to LAN. It is suitable for the scenario where there is no server in the LAN and multiple computers or mobile phones request data from the server. Like TCP Client, there are differences between connection and disconnection to ensure reliable exchange of data.
- 3) When work as TCP Server, it support Synchronous baud rate(RFC2217).
- 4) Active monitoring of local ports when 668 work as TCP Server, When connecting requests, respond and create

connections. If you cross the public network to access 668 of TCP Server, you need port mapping on the router.

- 5) In the case of TCP Server, 668 can accept up to 16 Client connections, and the local port number can't be set to 0.
- 6) 668 work as TCP Server. When the number of connections Client exceeds the maximum set, it will no longer be accessible.
- 7) ① 668 work as TCP Server, local port:20001(The default is from 20001~20008. make sure that the local ports of each path are different),then save.
② There are two ways to set up, use web pages or software.



The screenshot shows a web interface for configuring the device. At the top, there are three tabs: 'Serial', 'Network' (which is highlighted in orange), and 'Other'. Below the tabs, there are three configuration items: 'Workmode' with a dropdown menu set to 'TCPServer', 'Local Port' with a text input field containing '20001' (highlighted with a red border), and 'Workmode for SocketB' with a dropdown menu set to 'None'. A blue 'Save&Apply' button is located at the bottom right of the configuration area.

Figure 30 TCP Server setting

- ③ Click send, you can transmission data.

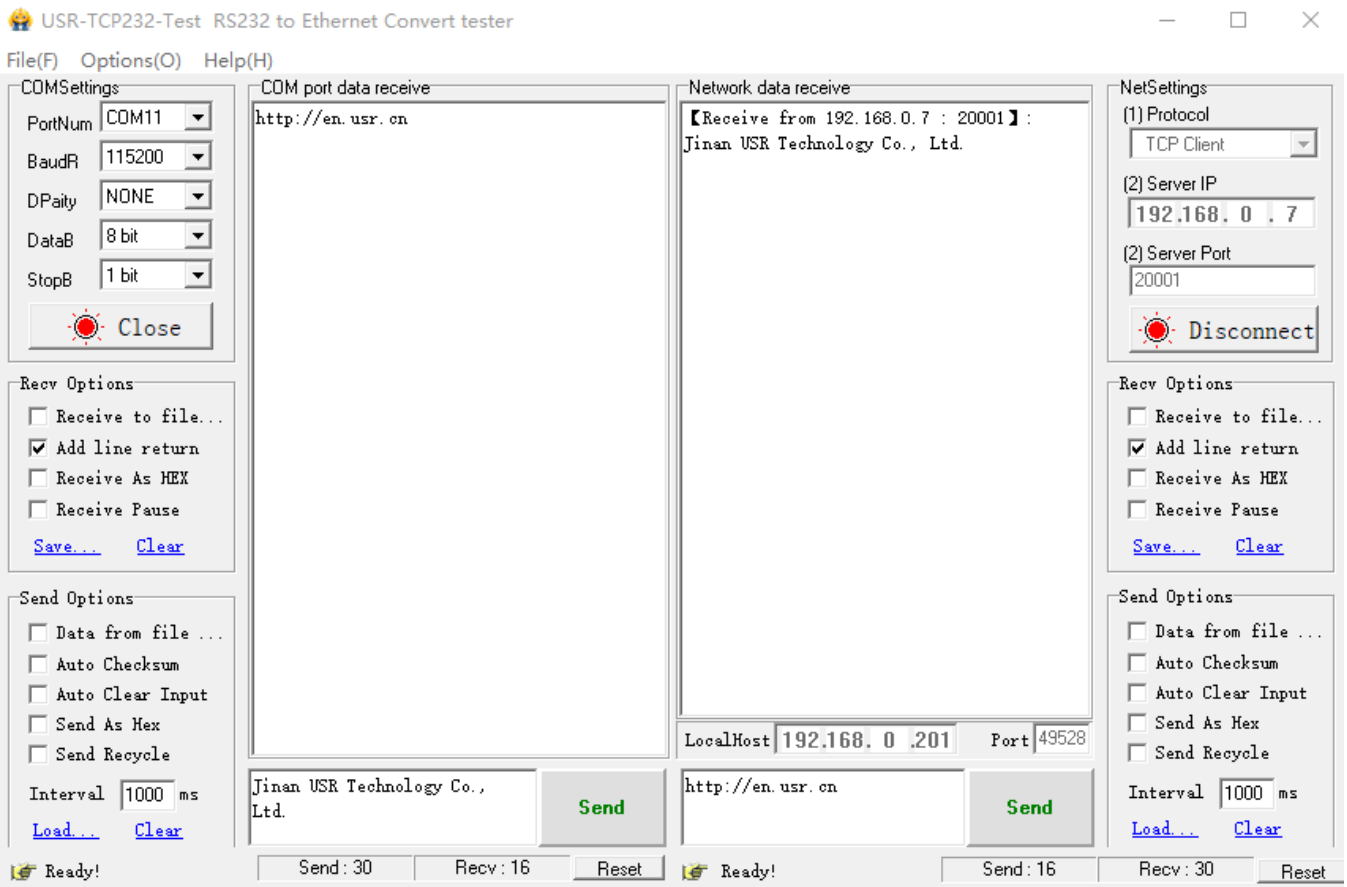

Figure 31 TCP Server transmission test

4.2.3. UDP Client

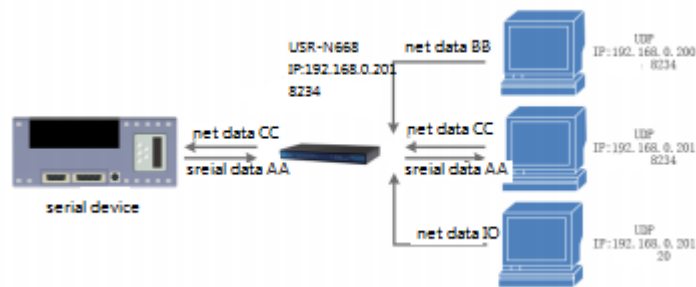
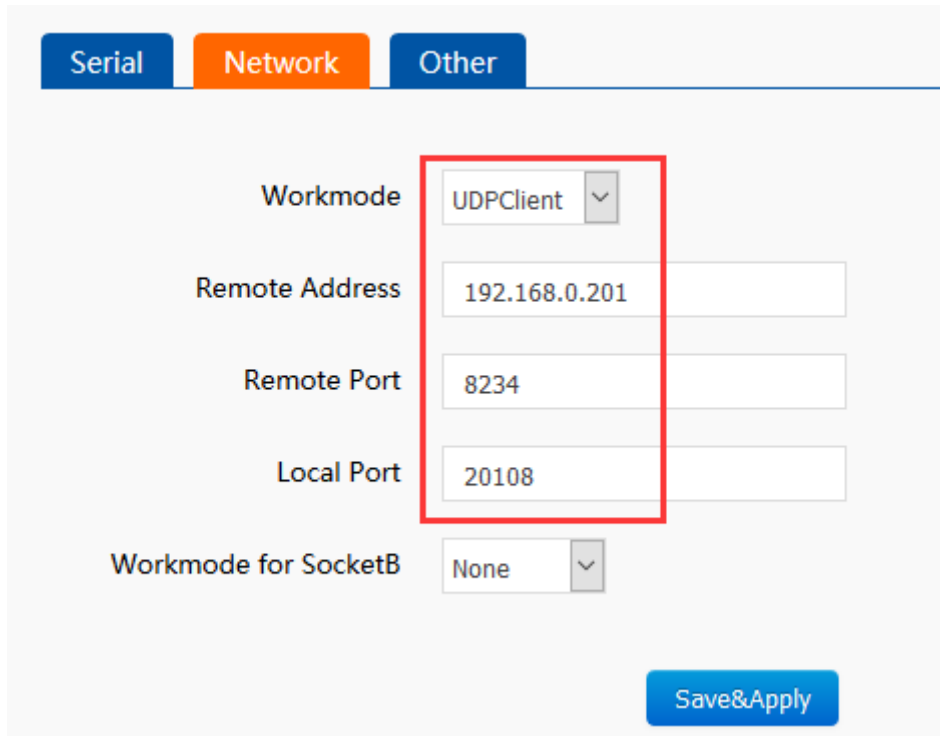

Figure 32 UDP Client mode

- 1) UDP transport protocol provides simple and unreliable communication services. No connection connected /disconnected.
- 2) When work at UDP Client, 668 only communication with target IP.
- 3) Target IP:255.255.255.255, it can achieve the effect of UDP full segment broadcast. 4015 and later firmware supports broadcast in the network segment, such as xxx.xxx.xxx.255's broadcast mode.
- 4) Can't support multicast.
- 5) ①Set up UDP Client ,target port:8234.



The screenshot shows a web interface for configuring a UDP Client. At the top, there are three tabs: 'Serial', 'Network', and 'Other'. The 'Network' tab is currently selected and highlighted in orange. Below the tabs, there are several configuration fields:

- Workmode:** A dropdown menu set to 'UDPClient'.
- Remote Address:** A text input field containing '192.168.0.201'.
- Remote Port:** A text input field containing '8234'.
- Local Port:** A text input field containing '20108'.
- Workmode for SocketB:** A dropdown menu set to 'None'.

A blue 'Save&Apply' button is located at the bottom right of the configuration area. A red rectangular box highlights the 'Workmode', 'Remote Address', 'Remote Port', and 'Local Port' fields.

Figure 33 UDP Client web set

- ② The software is set to UDP, the local IP is set to the PC IP, and the local port number is the target port number of 668. Click Connect. Open the serial port.
- ③ First click the serial port to send, receive the data, test software target IP and target port number to 668 IP and port number, and then click the network to send data to the serial port.

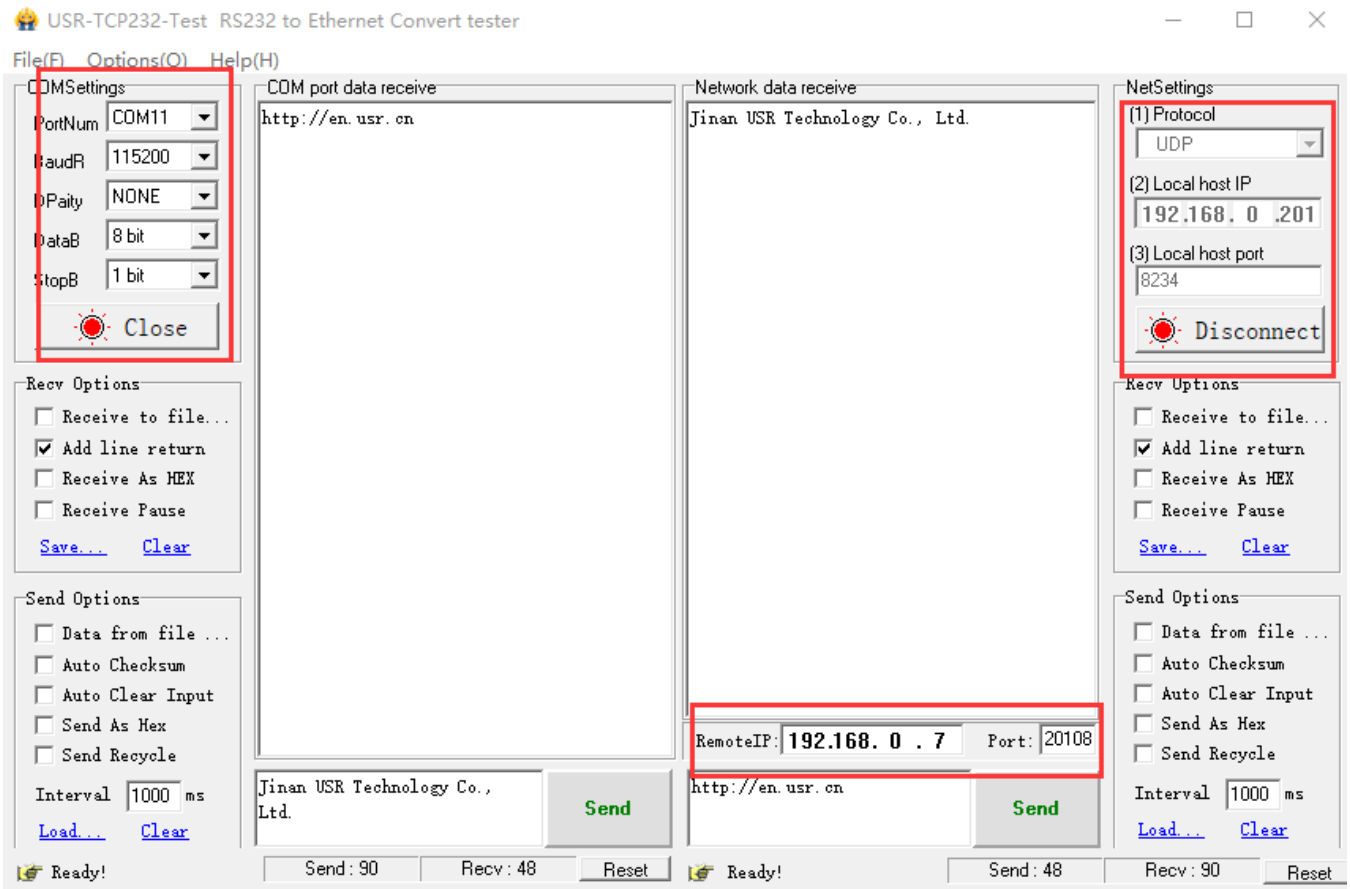

Figure 34 UDP Client test

4.2.4. UDP Server

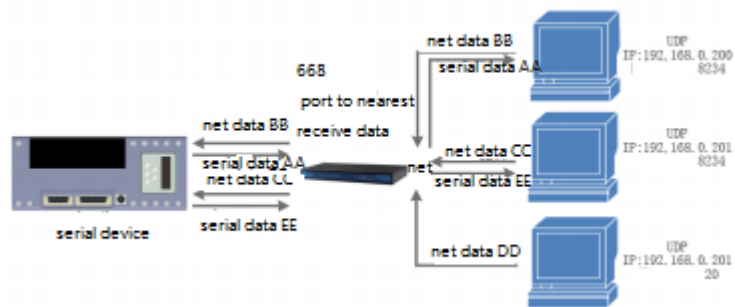

Figure 35 UDP Server mode

- 1) UDP Server means that the source IP address is not verified on the basis of ordinary UDP. After receiving a UDP packet, the destination IP is changed to the data source IP and port number. When sending data, the IP and port number are sent to the nearest communication.
- 2) This mode is usually used in data transmission scenarios where multiple network devices need to communicate with modules and do not want to use TCP because of their high speed and frequency.
- 3) ① Set up UDP Server, target port 20108.
② Open the "USR-TCP232-Test.exe", set up UDP mode, the local IP is the PC IP. Set the port different, e.g. 23 and 8234, click "connect". On the other side, set the IP and port all the 668 parameter.

③ Click the network send button on the software, the serial port receives all the data; click the send button on the serial port, and the software receives data only from the latest one communication with 668.

④ The setup method is the same as UDP Client.

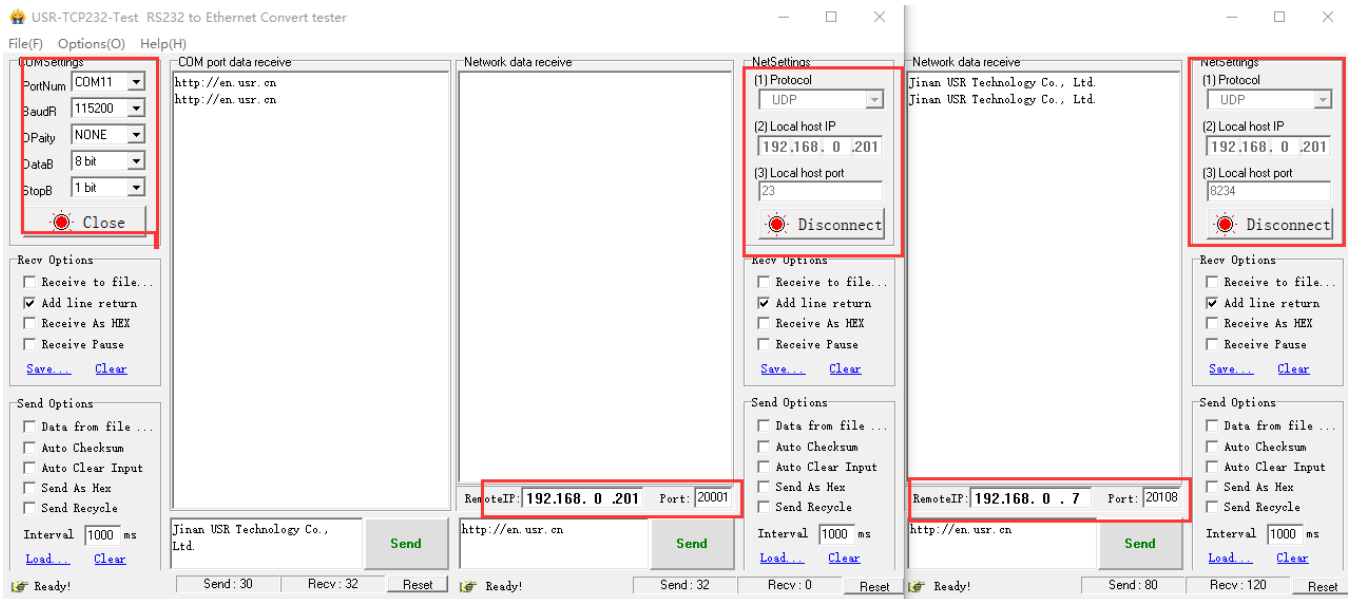
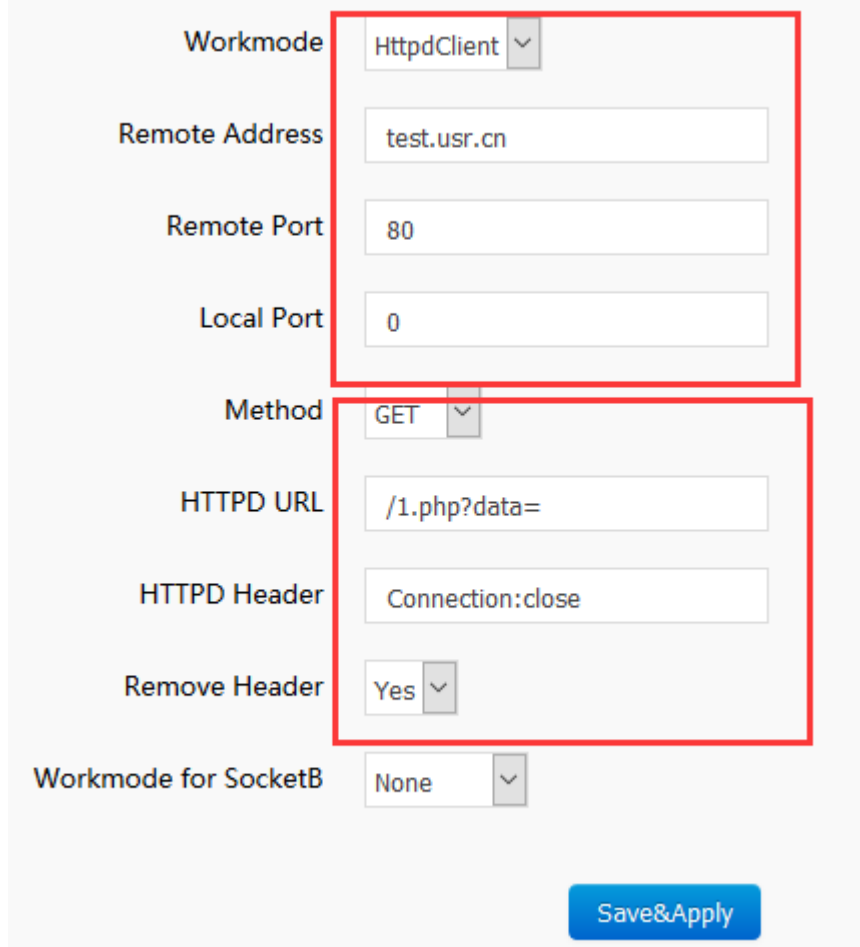

Figure 36 UDP Server testing

4.2.5. Httpd Client

- 1) In this mode, the user's terminal device can send the request data to the specified HTTP server through 668, and then 668 receives the data from the HTTP server, parses the data and sends the result to the serial port device.
- 2) Simple parameter settings, can transmission data from serial device to HTTP server.
- 3) Each time the data is sent, only the request data is sent, and 668 automatically adds information such as URL and packet header.
- 4)



Workmode	HttpdClient
Remote Address	test.usr.cn
Remote Port	80
Local Port	0
Method	GET
HTTPD URL	/1.php?data=
HTTPD Header	Connection:close
Remove Header	Yes
Workmode for SocketB	None

Save&Apply

Figure 37 Httpd Client web set

1. set up Httpd Client, target IP, domain name and target port.
2. Set up Httpd request mode through web page, and request URL and packet header information of package.
3. Httpd server recovery information packet header default removed.
4. Save and reload.
5. Now can send data after open serial port.
6. Reference below.

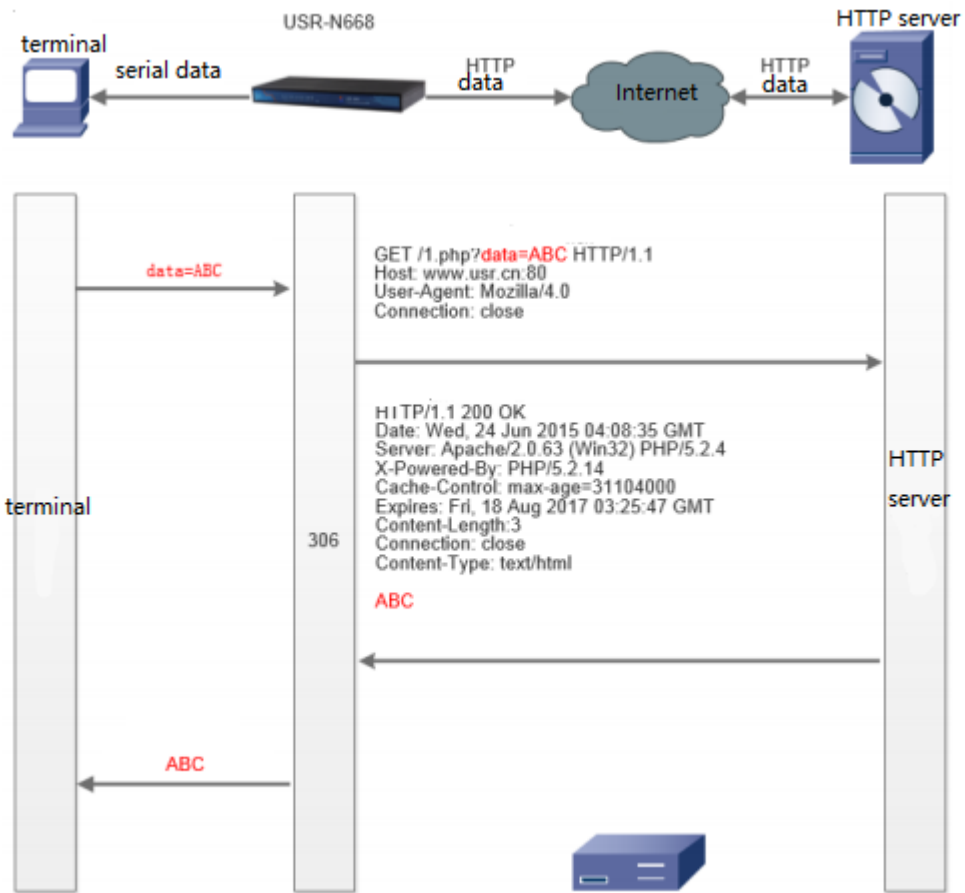

Figure 38 Httpd Client mode

4.2.6. SSL Client (Does not support in the current firmware)

Support SSL encryption on TCP links.

Target address: www.alipay.com , target port 443.

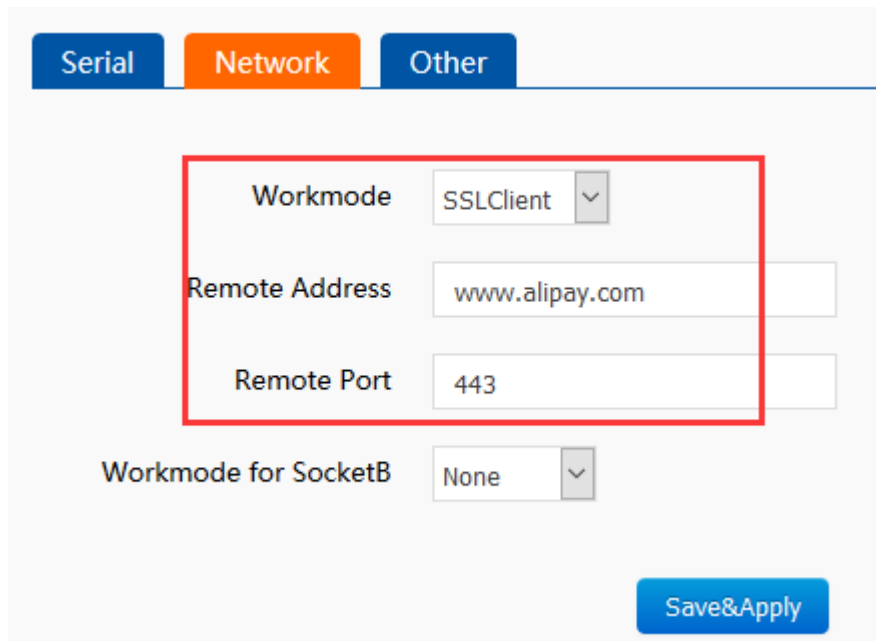

Figure 39 SSL Client setting

The HTTP request command has a carriage return line between adjacent rows.

```
GET https://www.alipay.com/
User-Agent: Mozilla/4.0
Host: www.alipay.com
```

Figure 40 SSL Client test

4.2.7. V-COM

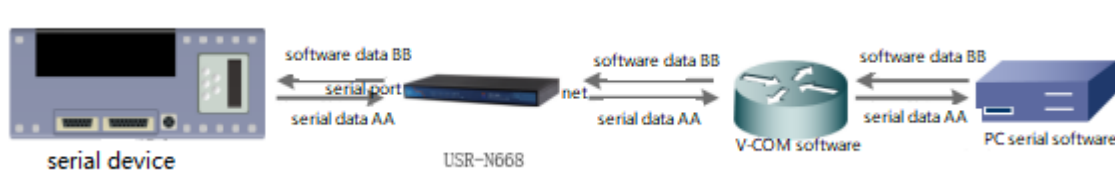

Figure 41 V-COM

User can download VCOM software from <http://www.usriot.com/usr-vcom-virtual-serial-software/>. Through this software user can set up connection between N668 and virtual serial to solve the problem that traditional equipment PC software used in serial port communication way.

1. set 668 TCP Server.
2. ① open V-COM, and add serial port;
② try to connect with 668.
3. e.g. as follow:

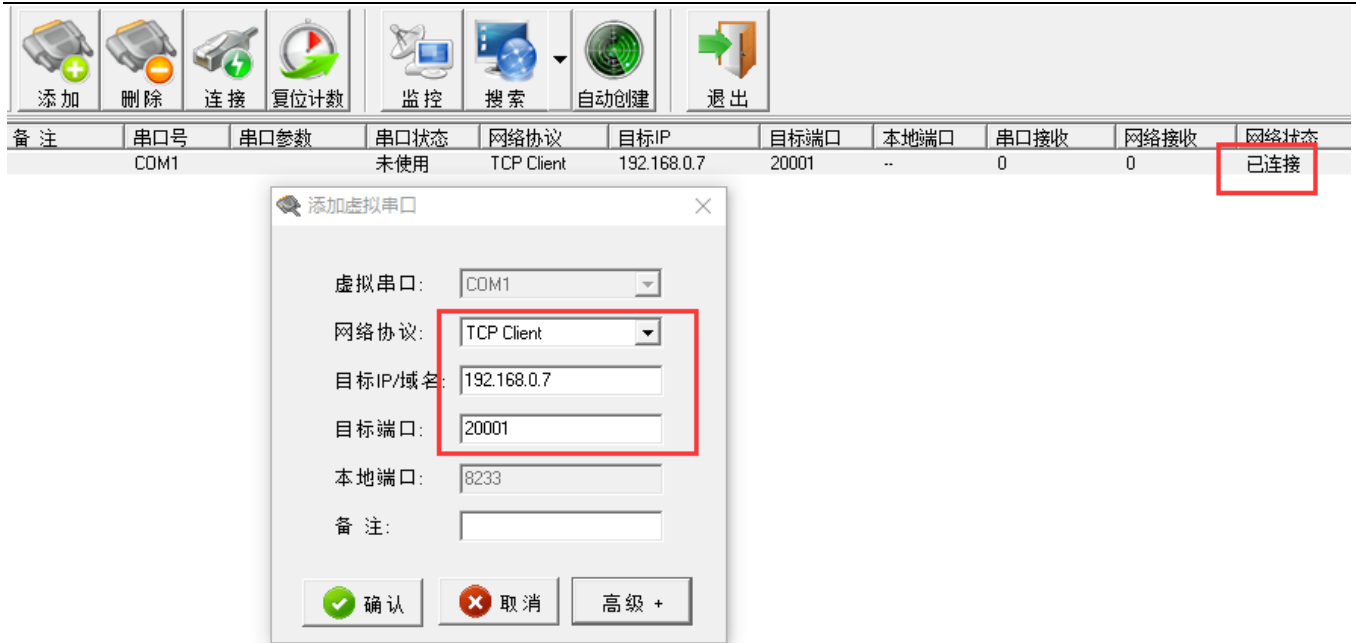

Figure 42 V-COM setting

4.3. Serial port Functions

4.3.1. Serial port framing mechanism

Because the data on the network side are transmitted in data frames, it is necessary to send the frame data through the serial port to the network side, so that the data can be transmitted more efficiently and quickly.

4.3.2. RFC2217-like

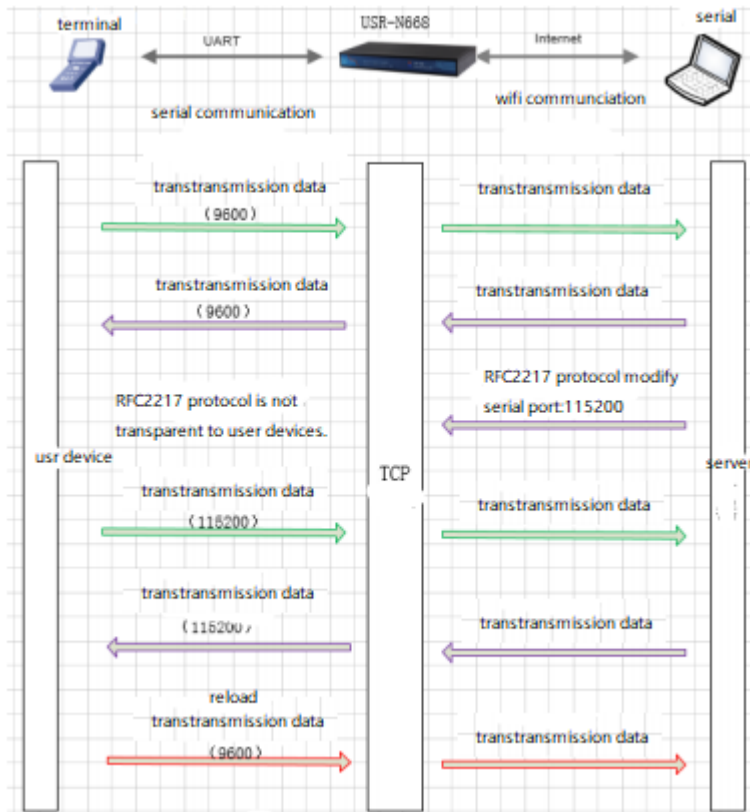

Figure 43 RFC2217

The RFC2217-like function realizes the function of dynamically changing the parameters of USR-N668 serial port from the network side during the operation of USR-N668. For example, in the running process, the serial port baud rate of the 668 server is changed from 115200bps to 9600bps.

RFC2217-like functions are mainly used in conjunction with VCOM. The default is the open state.

4.4. Characteristic function

4.4.1. Socket B

Implement a simple TCP / UDP Client function, the data received by the serial port, and send to Socket A and Socket B, and vice versa. It can be used for data backup links, and the working mechanism is consistent with Socket A.

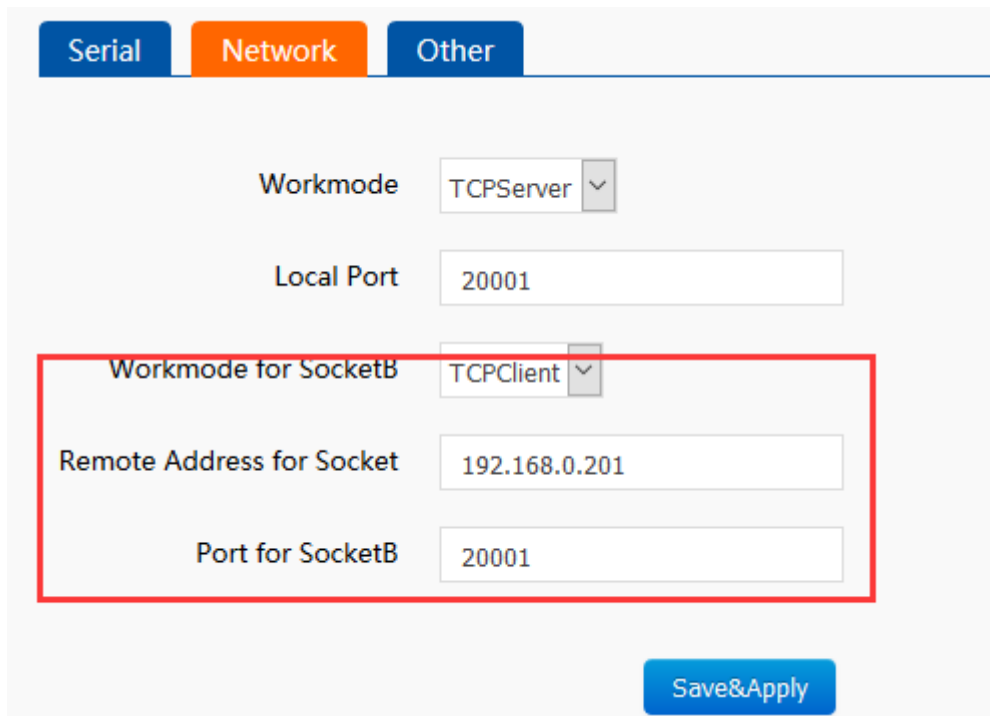

The screenshot shows a configuration interface with three tabs: 'Serial', 'Network', and 'Other'. The 'Network' tab is active. The settings are as follows:

Field	Value
Workmode	TCPServer
Local Port	20001
Workmode for SocketB	TCPClient
Remote Address for Socket	192.168.0.201
Port for SocketB	20001

A red rectangular box highlights the 'Workmode for SocketB', 'Remote Address for Socket', and 'Port for SocketB' fields. A blue 'Save&Apply' button is located at the bottom right of the form.

Figure 44 TCP Server setting

4.4.2. Heartbeat Packet Function

Heartbeat packet: Module will output heartbeat data to serial or network periodic. User can configure the heartbeat data and time interval. Serial heartbeat data can be used for polling Modbus data. Network heartbeat data can be used for showing connection status and keep the connection (only take effect in TCP/UDP Client mode).

The longest for Custom heartbeat package content is 40 bytes, the heartbeat time is 30 seconds, the range is 1~65535 seconds.

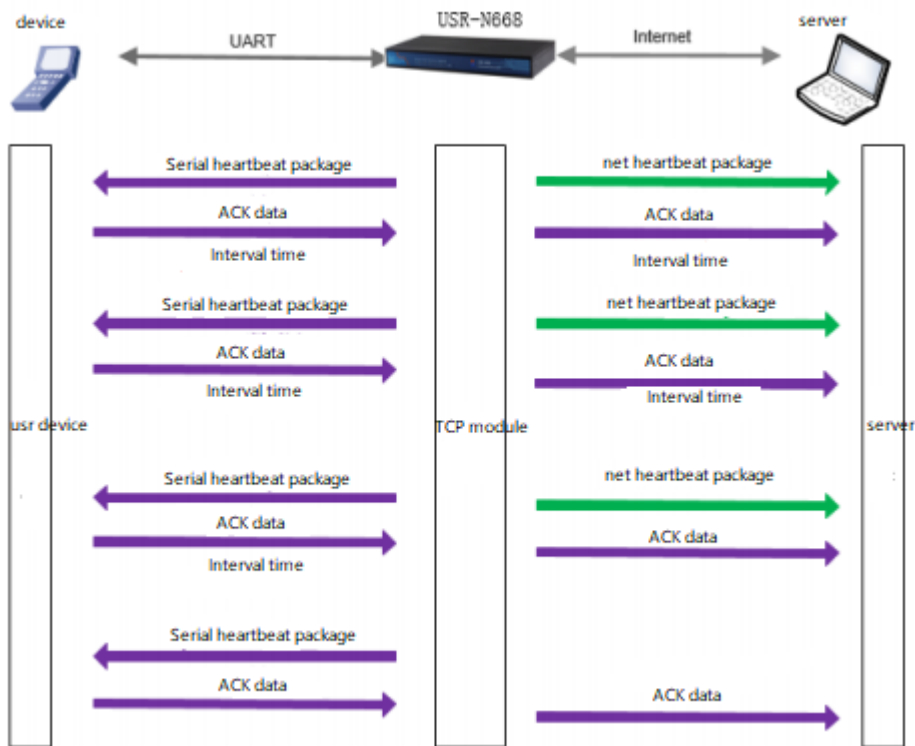

Figure 45 heartbeat packet function

Heartbeat packet can set through the web.

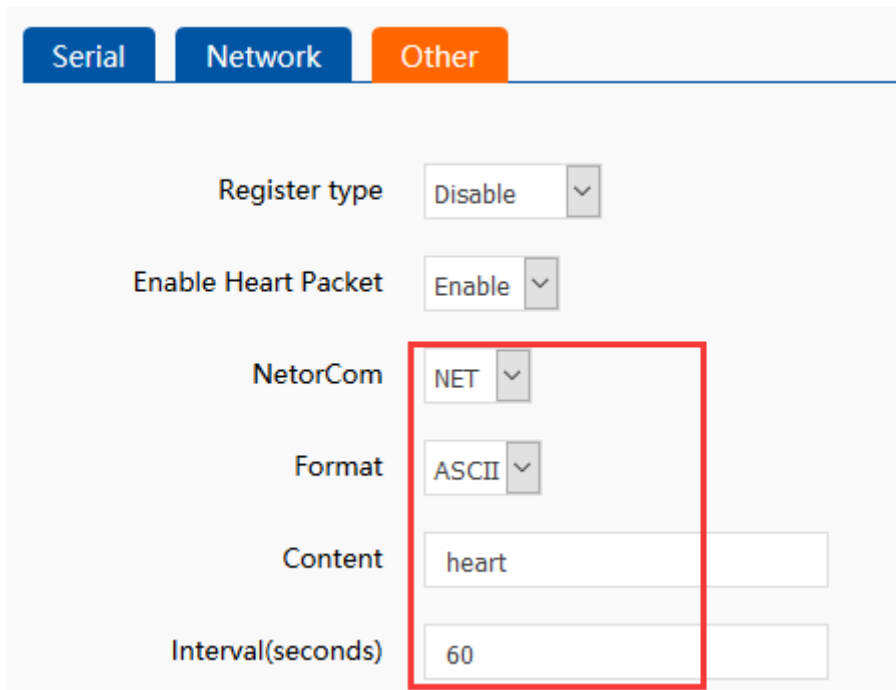

Figure 46 heartbeat packet function

4.4.3. Registration package

There are three kinds of registration packages: Custom registration package, transparent cloud, MAC registration package. Here is a custom registration package.

Custom registry packages have three kinds of situations: connection sending registry packages, data carrying registry packages, full registration (both are executed). Content can be based on customers. The user needs to be changed arbitrarily, up to 40 bytes, and supports sixteen binary input.

- ◆ Set up a connection to send a registry packet: After the connection is established, send the registry packet immediately, the main purpose is to enable the server to identify the data source device, or as a password to obtain server function authorization.



Figure 47 send registration package after connection

- ◆ Data portability: put the registration packet in the front of data, which is mainly used for protocol transmission.



Figure 48 data with registration package

The function can be set through web pages.

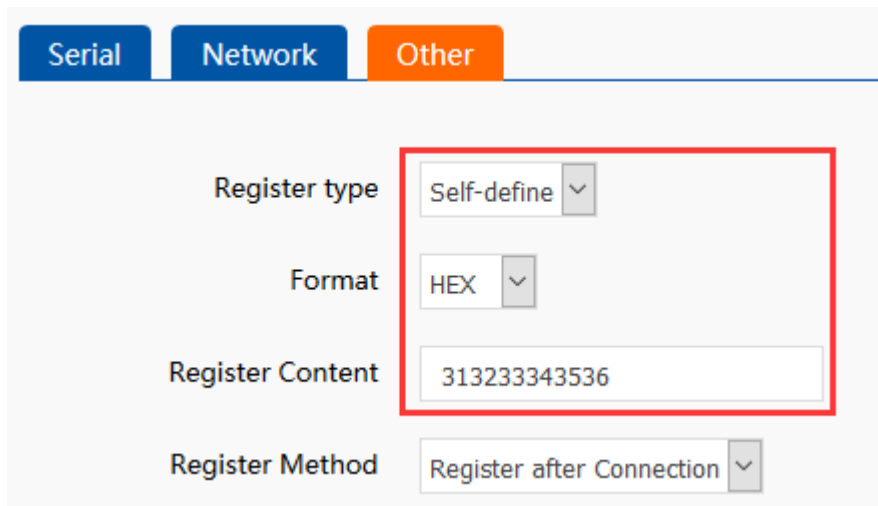

Figure 49 registration package

4.4.4. Modbus TCP

This device provides ModbusTCP turn to ModbusRTU function and defaults by default.

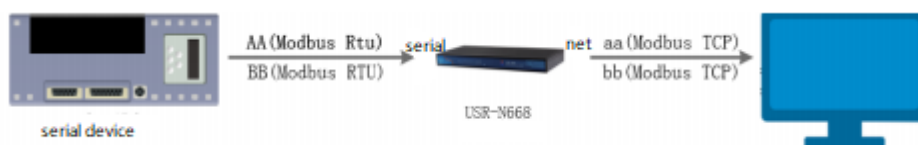

Figure 50 modbus TCP data flow

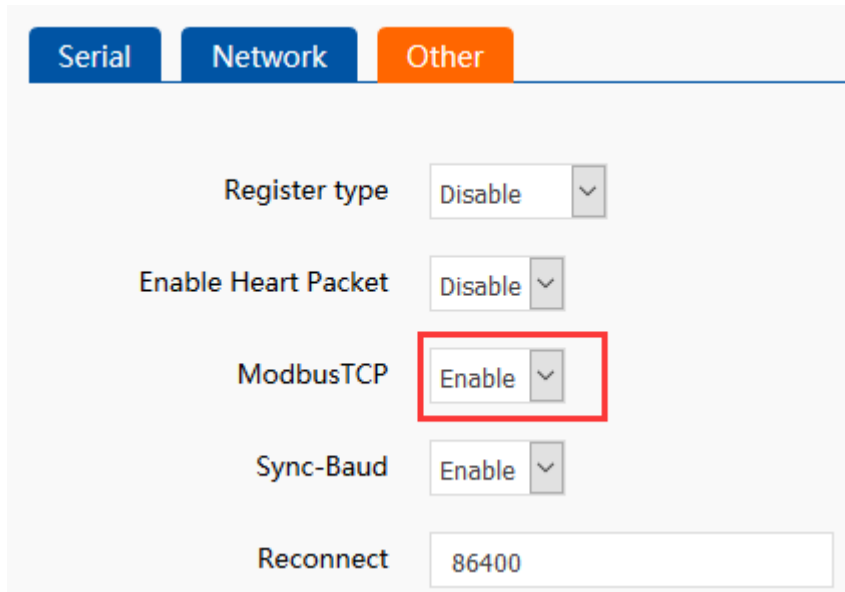

Figure 51 modbus TCP setting

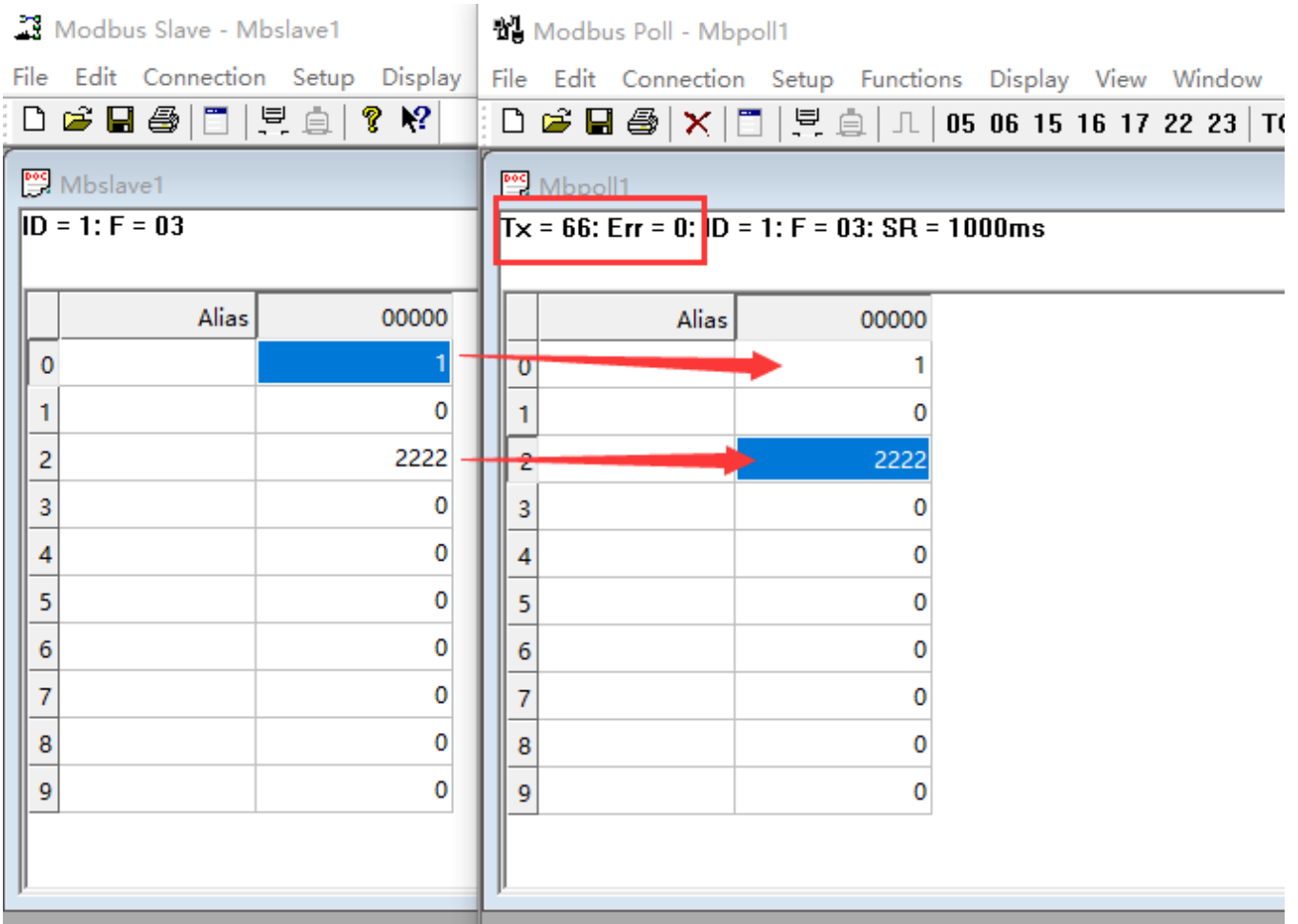

Figure 52 modbus TCP test

4.4.5. No data reconnection

The device provides a way to disconnect and reconnect, to eliminate the existence of dead links, the default function is 86400 seconds, that is, 24 hours.

When a TCP link is established and no data is received for a certain period of time, the device disconnects and reconnects the current link (note that only the TCP Client does). This eliminates the existence of some dead links to facilitate the stability of PC software.

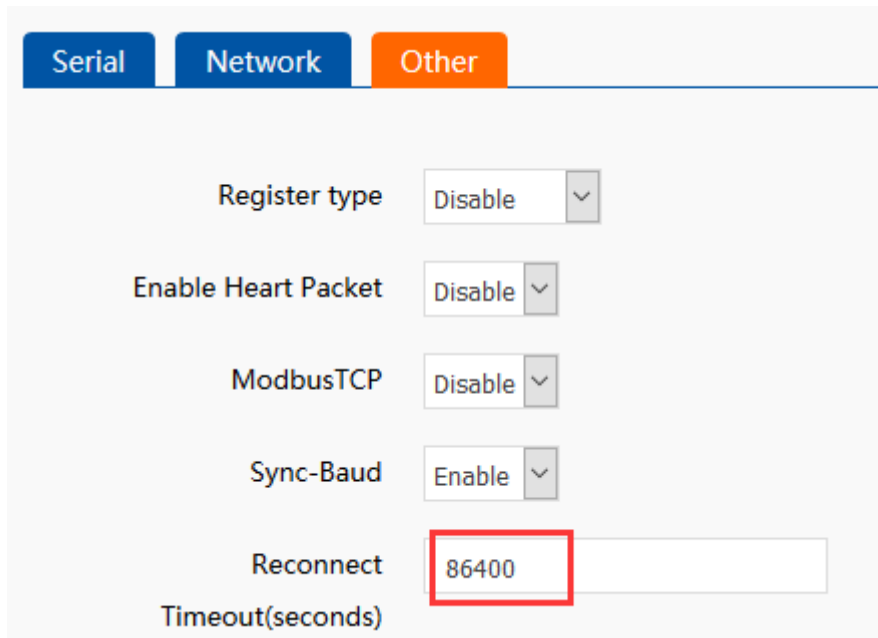

Figure 53 no data reconnection setting

4.4.6. DDNS

Support dynamic DNS.

Figure 54 DDNS setting

Figure 55 DDNS test

4.4.7. Remote management and remote monitoring

Remote monitoring realizes remote device state management.

Through server software, we can see the on-line state, running time and traffic information of the device.

Default not open.

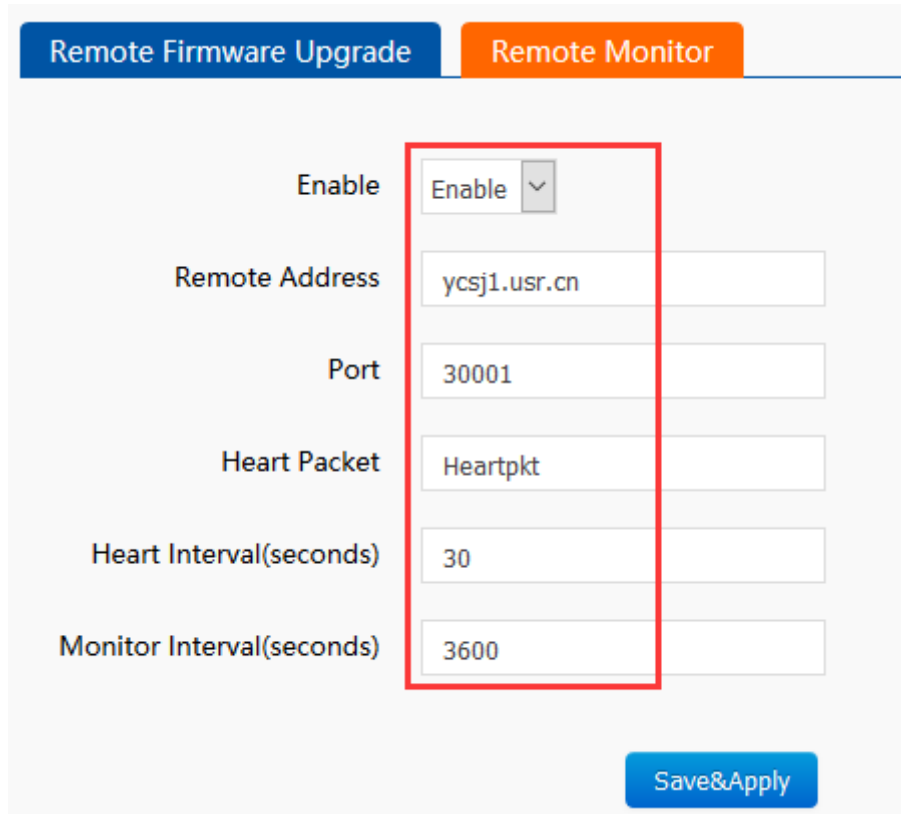

Remote Firmware Upgrade | **Remote Monitor**

Enable: Enable ▾

Remote Address: ycsj1.usr.cn

Port: 30001

Heart Packet: Heartpkt

Heart Interval(seconds): 30

Monitor Interval(seconds): 3600

Save&Apply

Figure 56 Remote management and remote monitoring

Remote firmware upgrade can upgrade firmware by server.

The default is not opened.

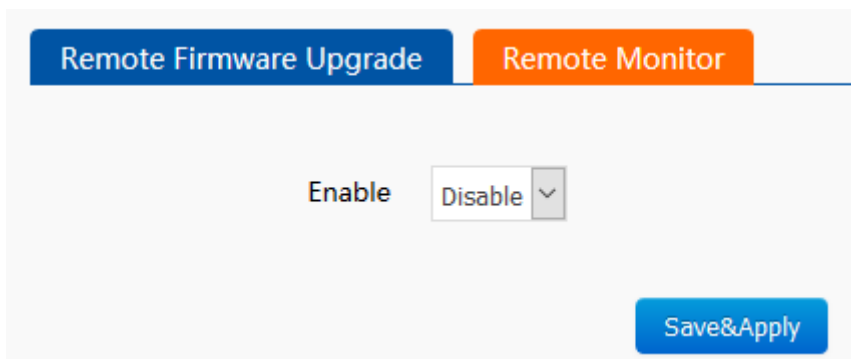

Remote Firmware Upgrade | Remote Monitor

Enable: Disable ▾

Save&Apply

Figure 57 Remote firmware upgrade

Attention:

This function and remote server are all trial run.

Remote server login address <https://ycsj1.usr.cn/index.php/Public/login>

4.4.8. Scheduled task

This function can carry out instructions to the device by way of dividing, time, day, month and week.

Syntax is shell instruction.

Schedule Task

Self-define system crontab task.

```
*/10 * * * * echo crontest:`date` > /tmp/cron.log  
*/5 * * * * /mnt/user/dhcp_renew.sh  
*/1 * * * * /mnt/user/reset_timeout.sh
```

Figure 58 scheduled task

5.Parameter setting

668 setting parameter method : software and web page.

User configuration process:

Search-Setting IP Address Acquisition- Serial Port Parameters-668 Working Mode-Work parameters

In order to ensure the normal use of the software, we need to take the following steps:

1. When setting parameters with settings software, it is necessary to ensure that all device in the same LAN.
2. turn off the anti-virus software and firewall on the computer.
3. close the NIC that has nothing to do with this test.

5.1. Network protocol settings parameters

5.1.1. Software setting parameters

Search all the N668 in the LAN.

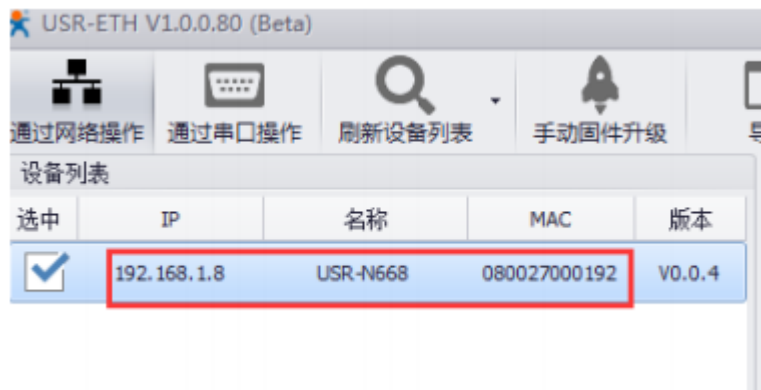

Figure 59 search

1. Read parameter

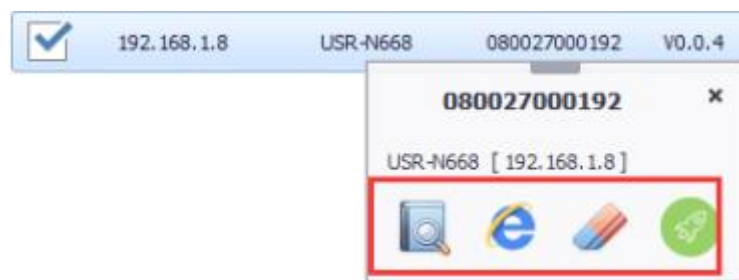

Figure 60 equipment operation

2. Setting the main parameter

IP设置	
获取方式, IP地址, 子网掩码, 网关	STATIC, 192.168.0.7, 255.255.255.0, 192.168.0.1
DNS服务器, 备用DNS服务器	208.67.222.222, 8.8.8.8

Figure 61 Setting the main parameter

- IP address type: static and DHCP
- The static IP:668 is set up in the same network segment as router IP.
- Subnet mask: General default 255.255.255.0
- Gateway: generally routers IP, set up correctly in order to cross network segment communication, and domain name resolution.
- Device name: the name can be customized.
- Webpage port: port number when accessing web page is default 80

3. Serial port parameter setting



Figure 62 Serial port parameter setting

- Serial baud rate: baud rate of serial communication , does not support custom baud rate.
- Check / data / stop: serial port parameters
- Work mode: 668 of the work is TCP Server /TCP Client/HTTPD Client/UDP Client/ UDP Server
- Target IP / Domain Name: The target IP which 668 work as the client (TCP Client / HTTPD Client / UDP Client)
- Local port: set 0 when 668 work as TCP Client, i.e. issued as a random port number

Attention:

- When using the software to set parameters through the network, **the display will be forced to open.**
- Configure parameters through serial port. As follows, the steps are to operate through the serial port - > open the serial port - > enter the configuration state, and then click read reference.



Figure 63 software

- Modify PC's IP and module in the same network segment, or use serial configuration parameters.

5.1.2. Setting protocol settings parameters

By setting up the protocol, you can complete the process of search > setting > Restart (save parameters).

5.2. Web settings parameters

Open the browser and enter the IP address of 668. By default (192.168.0.7), you can open the login interface of 668.

Enter

user name: admin

Password admin

Click login, you can enter the login screen.

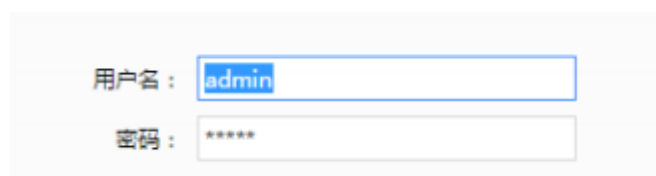
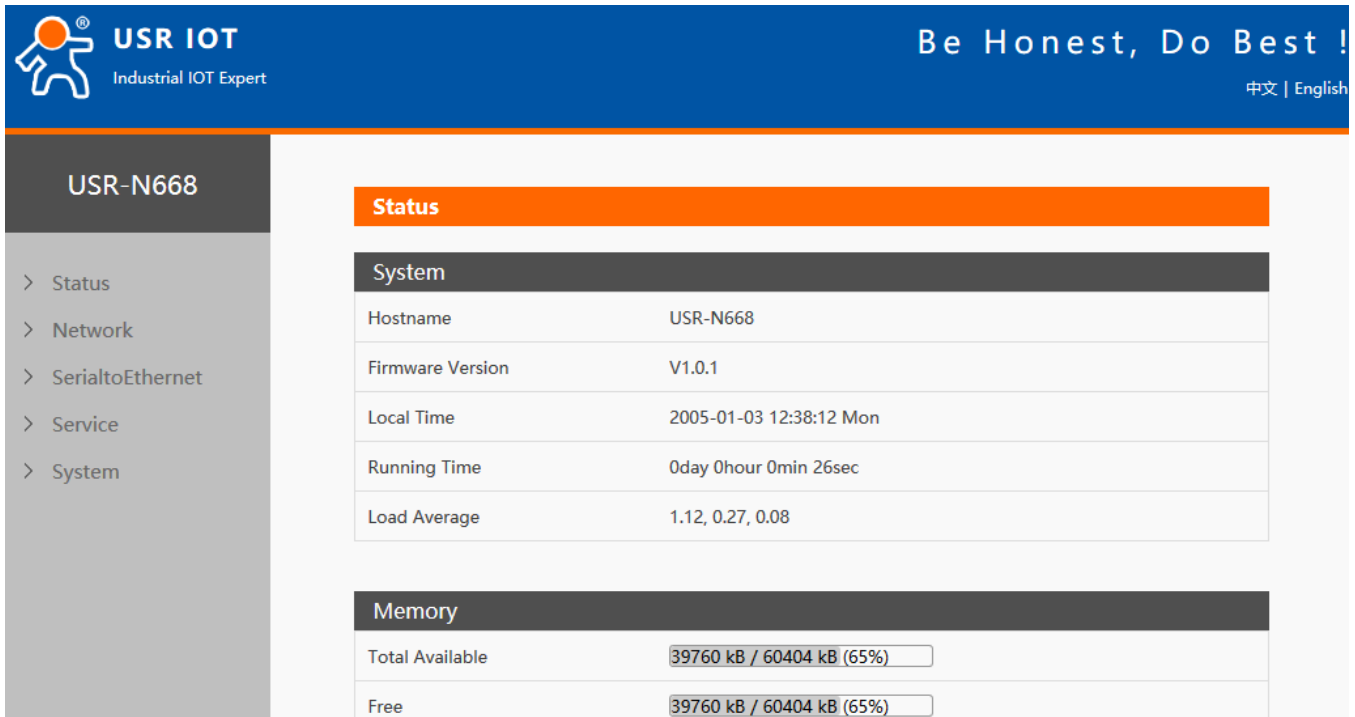

Figure 64 login in



The screenshot shows the USR IOT web interface for the USR-N668 device. The header includes the USR IOT logo and the slogan "Be Honest, Do Best!". A navigation menu on the left lists: Status, Network, SerialtoEthernet, Service, and System. The main content area displays the "Status" page, which is divided into two sections: "System" and "Memory".

System	
Hostname	USR-N668
Firmware Version	V1.0.1
Local Time	2005-01-03 12:38:12 Mon
Running Time	0day 0hour 0min 26sec
Load Average	1.12, 0.27, 0.08

Memory	
Total Available	39760 kB / 60404 kB (65%)
Free	39760 kB / 60404 kB (65%)

Figure 65 web shows

1. The current status page shows some basic information about 668:

- 668 name
- Current IP address
- MAC address

2. Local IP settings

Modify the parameters that need to be set on this page, click Save Settings, and then modify the parameters of the next page. If no other parameters need to be changed, Click Restart.

- IP address acquisition mode
- IP
- Subnet mask
- gateway address
- DNS server

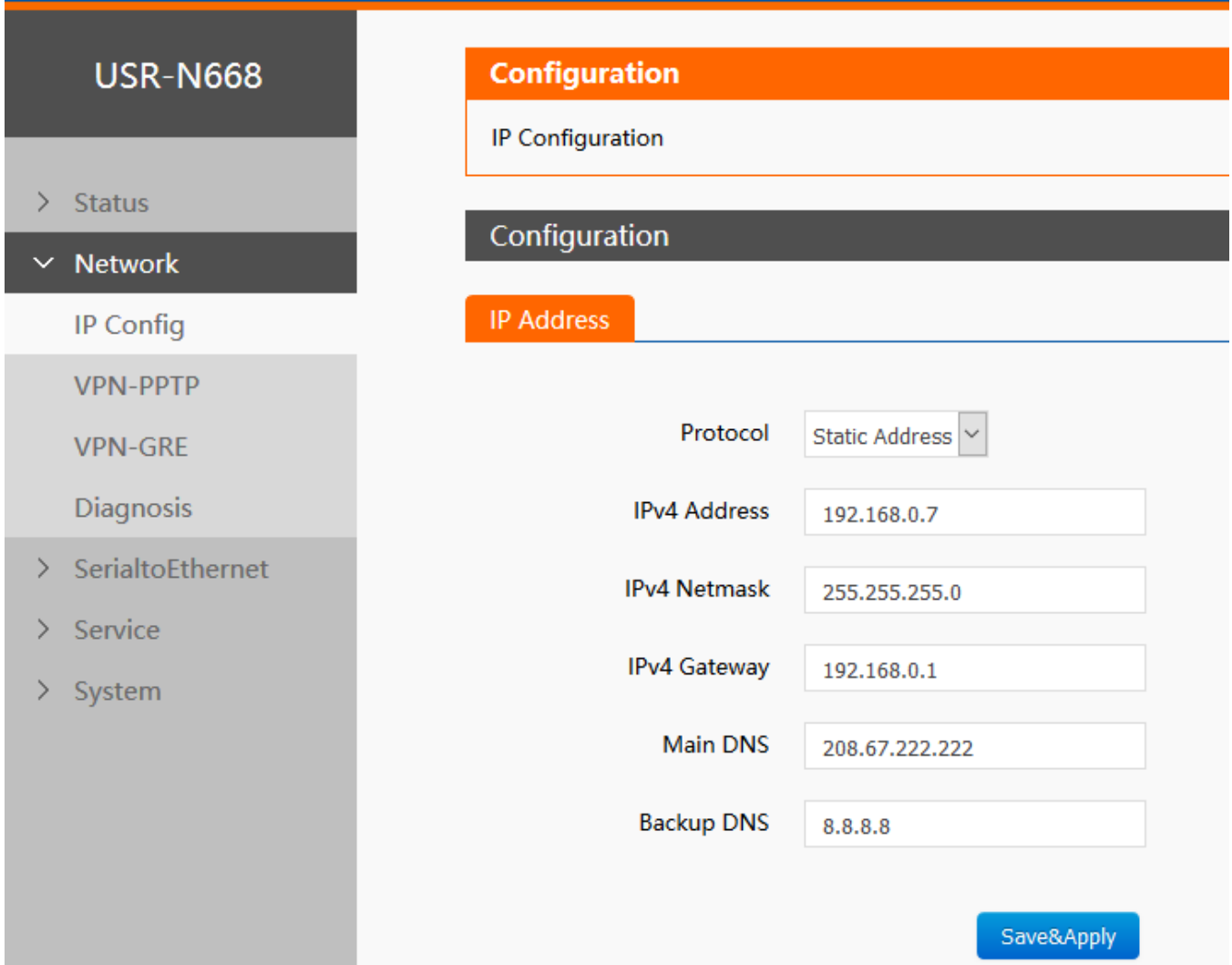

The screenshot shows the web interface for the USR-N668 device. On the left is a navigation menu with the following items: USR-N668, Status, Network (expanded), IP Config, VPN-PPTP, VPN-GRE, Diagnosis, SerialtoEthernet, Service, and System. The main content area is titled 'Configuration' and has a sub-section 'IP Address'. The settings are as follows:

Protocol	Static Address
IPv4 Address	192.168.0.7
IPv4 Netmask	255.255.255.0
IPv4 Gateway	192.168.0.1
Main DNS	208.67.222.222
Backup DNS	8.8.8.8

A 'Save&Apply' button is located at the bottom right of the configuration area.

Figure 66 IP setting

3. Port parameters

- Baud rate
- Data bits
- Check digit
- Stop bits
- The way of work
- Remote server address
- Local port
- Remote port
- Special functions

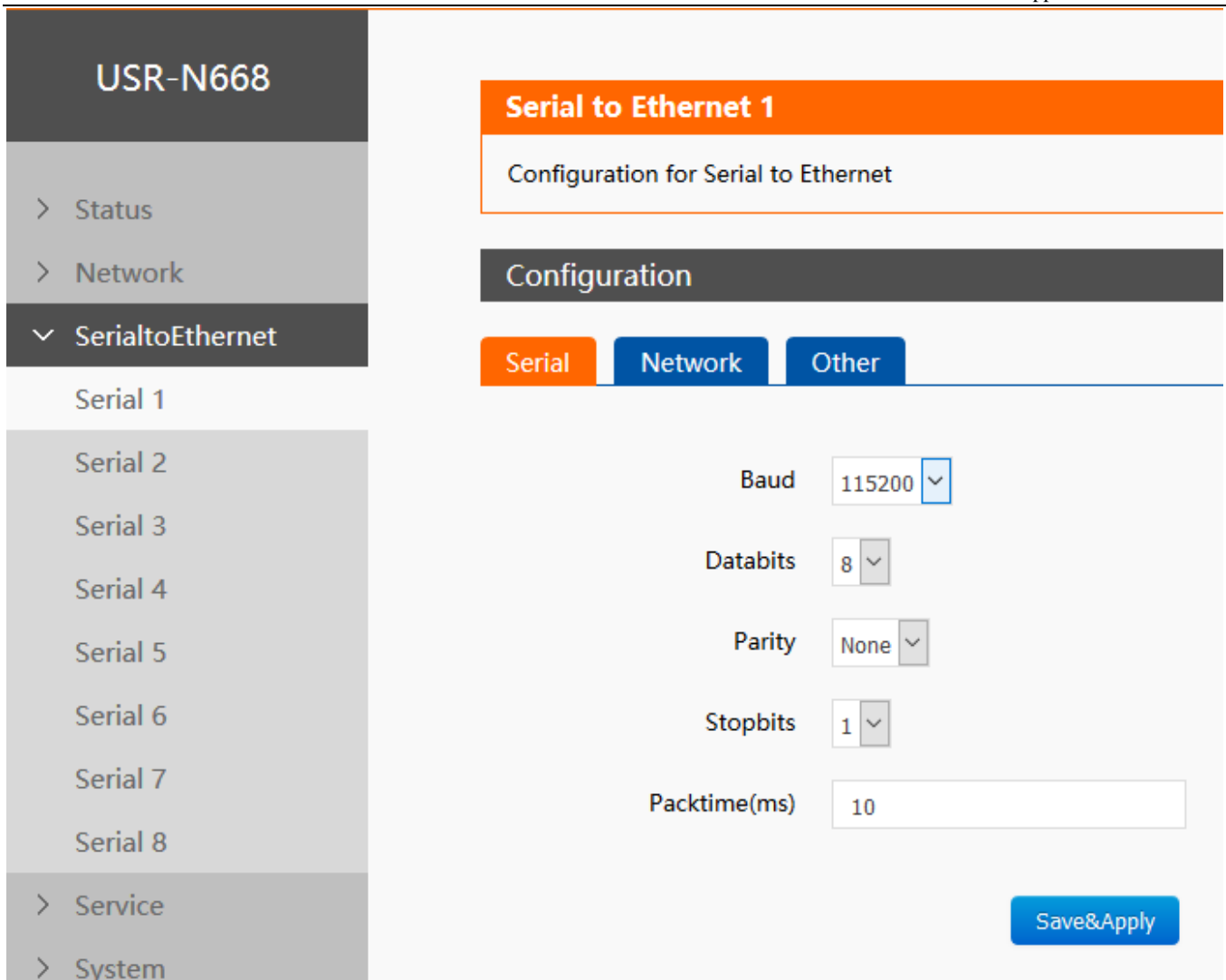

USR-N668

- > Status
- > Network
- ▼ SerialtoEthernet
 - Serial 1
 - Serial 2
 - Serial 3
 - Serial 4
 - Serial 5
 - Serial 6
 - Serial 7
 - Serial 8
 - > Service
 - > System

Serial to Ethernet 1

Configuration for Serial to Ethernet

Configuration

Serial Network Other

Baud: 115200

Databits: 8

Parity: None

Stopbits: 1

Packtime(ms): 10

Save&Apply

Figure 67 port parameters

4. Extension function

- Customize heartbeat package function: it can be opened through web page, content is customized, the longest is 40 bytes.
- Custom registration package function: can be opened through the web page, content customization, up to 40 bytes, the use of custom registration package.
- USR-Cloud number and password.
- Synchronization baud rate (2217): the function of synchronous baud rate can be opened through webpage.

5.3. AT command

5.3.1. AT command

The UART port: baud rate 115200, no check, 8 bit data bits, 1 bit stop bits.

- Input "+ + +" on UART, the module will return a confirmation code "a" after receiving "+ + +".
- Enter the confirmation code "a" on UART. After receiving the confirmation code, the module returns the confirmation of "+OK" and enters the command mode.



Figure 68 AT command

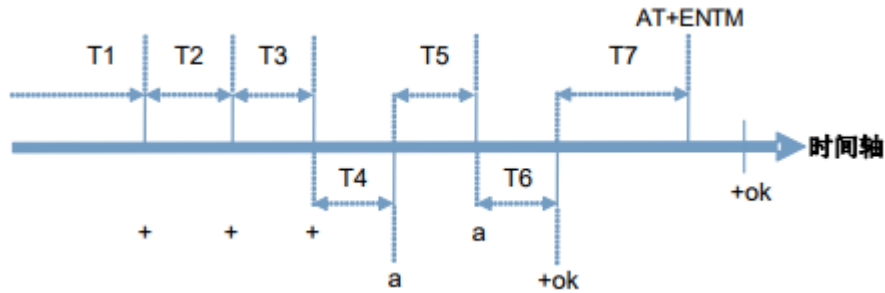

Figure 69 Time sequence diagram

Time requirements:

T1 > serial port packing interval

T2 << 300ms

T3 << 300ms

T5 << 3S

The transition from transmissions mode to temporary instruction mode:

1. The serial port device sends "++" to the module continuously. When the module receives "++", it sends a "a" to the device. No data can be sent before sending "++".
2. When the device receives "a", it must send a "a" to the module within 3 seconds.
3. After receiving the "a", module sends the "+OK" to the device and enters the "AT instruction mode".
4. When the device receives "+OK", it knows that the module has entered "AT instruction mode" and can send AT instructions to it.

Switching from the AT instruction mode to the network pass through sequence:

1. The serial port sends the instruction "AT+ENTM" to the module.
2. Module returns the "+OK" after receiving the instruction and returns to the previous mode.

5.3.2. Error code

Table 10 Error code

Error code	Describe
-1	Invalid command format
-2	Invalid command
-3	Invalid operator
-4	Invalid parameters
-5	operation not permitted

6.Contact Us

Company: Jinan USR IOT Technology Limited

Address: Floor 11, Building 1, No. 1166 Xinluo Street, Gaoxin District, Jinan, Shandong, 250101, China

Web: www.usriot.com

Support: h.usriot.com

Email: sales@usr.cn

Tel: 86-531-88826739/86-531-55507297

7.Disclaimer

This document provide the information of USR-N668 products, it hasn't been granted any intellectual property license by forbidding speak or other ways either explicitly or implicitly. Except the duty declared in sales terms and conditions, we don't take any other responsibilities. We don't warrant the products sales and use explicitly or implicitly, including particular purpose merchantability and marketability, the tort liability of any other patent right, copyright, intellectual property right. We may modify specification and description at any time without prior notice.

8.Update History

Edition	Describe
V1.0.1	2017-07-14 establish
V1.0.2	2017-07-20 modify web page screenshots, statements
V1.0.3	remove hardware manual description
V1.0.4V	add number of accessories