

Content

CHAPTER 1 VLAN CONFIGURATION	1-1
1.1 VLAN CONFIGURATION	1-1
1.1.1 Introduction to VLAN.....	1-1
1.1.2 VLAN Configuration Task List	1-2
1.1.3 Typical VLAN Application	1-5
1.1.4 Typical Application of Hybrid Port	1-6
1.2 GVRP CONFIGURATION.....	1-8
1.2.1 Introduction to GVRP	1-8
1.2.2 GVRP Configuration Task List.....	1-9
1.2.3 Example of GVRP.....	1-10
1.2.4 GVRP Troubleshooting.....	1-12
1.3 DOT1Q-TUNNEL CONFIGURATION	1-12
1.3.1 Introduction to Dot1q-tunnel	1-12
1.3.2 Dot1q-tunnel Configuration	1-13
1.3.3 Typical Applications of the Dot1q-tunnel.....	1-14
1.3.4 Dot1q-tunnel Troubleshooting	1-15
1.4 VLAN-TRANSLATION CONFIGURATION.....	1-15
1.4.1 Introduction to VLAN-translation.....	1-15
1.4.2 VLAN-translation Configuration.....	1-15
1.4.3 Typical application of VLAN-translation.....	1-16
1.4.4 VLAN-translation Troubleshooting	1-17
1.5 DYNAMIC VLAN CONFIGURATION	1-18
1.5.1 Introduction to Dynamic VLAN.....	1-18
1.5.2 Dynamic VLAN Configuration	1-18
1.5.3 Typical Application of the Dynamic VLAN	1-20
1.5.4 Dynamic VLAN Troubleshooting.....	1-21
1.6 VOICE VLAN CONFIGURATION.....	1-22
1.6.1 Introduction to Voice VLAN	1-22
1.6.2 Voice VLAN Configuration	1-23
1.6.3 Typical Applications of the Voice VLAN	1-23

1.6.4 Voice VLAN Troubleshooting	1-25
1.7 SUPER VLAN CONFIGURATION	1-25
1.7.1 Introduction to Super VLAN	1-25
1.7.2 Super VLAN Configuration	1-27
1.7.3 Typical Application of Super VLAN.....	1-28
1.7.4 Super VLAN Troubleshooting.....	1-29
CHAPTER 2 MAC TABLE CONFIGURATION.....	2-1
2.1 INTRODUCTION TO MAC TABLE	2-1
2.1.1 Obtaining MAC Table	2-1
2.1.2 Forward or Filter	2-3
2.2 MAC ADDRESS TABLE CONFIGURATION TASK LIST	2-4
2.3 TYPICAL CONFIGURATION EXAMPLES	2-5
2.4 MAC TABLE TROUBLESHOOTING	2-6
2.5 MAC NOTIFICATION CONFIGURATION	2-6
2.5.1 Introduction to MAC Notification	2-6
2.5.2 MAC Notification Configuration	2-6
2.5.3 MAC Notification Example	2-8
2.5.4 MAC Notification Troubleshooting.....	2-8

Chapter 1 VLAN Configuration

1.1 VLAN Configuration

1.1.1 Introduction to VLAN

VLAN (Virtual Local Area Network) is a technology that divides the logical addresses of devices within the network to separate network segments basing on functions, applications or management requirements. By this way, virtual workgroups can be formed regardless of the physical location of the devices. IEEE announced IEEE 802.1Q protocol to direct the standardized VLAN implementation, and the VLAN function of switch is implemented following IEEE 802.1Q.

The key idea of VLAN technology is that a large LAN can be partitioned into many separate broadcast domains dynamically to meet the demands.

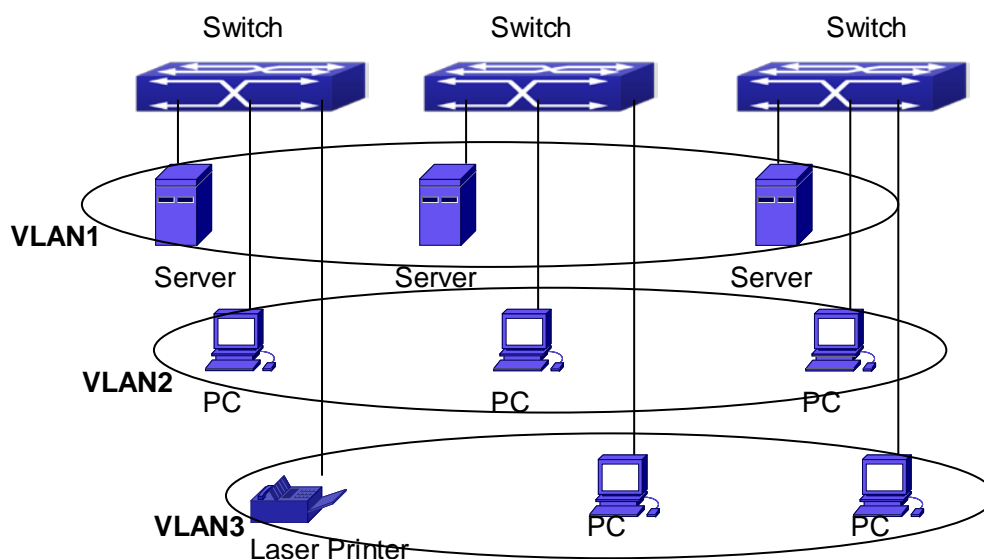

Fig 1-1 A VLAN network defined logically

Each broadcast domain is a VLAN. VLANs have the same properties as the physical LANs, except VLAN is a logical partition rather than physical one. Therefore, the partition of VLANs can be performed regardless of physical locations, and the broadcast, multicast and unicast traffic within a VLAN is separated from the other VLANs.

With the aforementioned features, VLAN technology provides us with the following

convenience:

- ☞ Improving network performance
- ☞ Saving network resources
- ☞ Simplifying network management
- ☞ Lowering network cost
- ☞ Enhancing network security

Switch Ethernet Ports can work in three kinds of modes: Access, Hybrid and Trunk, each mode has a different processing method in forwarding the packets with tagged or untagged.

The ports of Access type only belong to one VLAN, usually they are used to connect the ports of the computer.

The ports of Trunk type allow multi-VLANs to pass, can receive and send the packets of multi-VLANs. Usually they are used to connect between the switches.

The ports of Hybrid type allow multi-VLANs to pass, can receive and send the packets of multi-VLANs. They can be used to connect between the switches, or to a computer of the user.

Hybrid ports and Trunk ports receive the data with the same process method, but send the data with different method: Hybrid ports can send the packets of multi-VLANs without the VLAN tag, while Trunk ports send the packets of multi-VLANs with the VLAN tag except the port native VLAN.

The switch implements VLAN and GVRP (GARP VLAN Registration Protocol) which are defined by 802.1Q. The chapter will explain the use and the configuration of VLAN and GVRP in detail.

1.1.2 VLAN Configuration Task List

1. Create or delete VLAN
2. Set or delete VLAN name
3. Assign Switch ports for VLAN
4. Set the switch port type
5. Set Trunk port
6. Set Access port
7. Set Hybrid port
8. Enable/Disable VLAN ingress rules on ports
9. Configure Private VLAN
10. Set Private VLAN association
11. Specify internal VLAN ID

1. Create or delete VLAN

Command	Explanation
Global Mode	
vlan WORD no vlan WORD	Create/delete VLAN or enter VLAN Mode

2. Set or delete VLAN name

Command	Explanation
VLAN Mode	
name <vlan-name> no name	Set or delete VLAN name.

3. Assigning Switch ports for VLAN

Command	Explanation
VLAN Mode	
switchport interface <interface-list> no switchport interface <interface-list>	Assign Switch ports to VLAN.

4. Set the Switch Port Type

Command	Explanation
Port Mode	
switchport mode {trunk access hybrid}	Set the current port as Trunk, Access or Hybrid port.

5. Set Trunk port

Command	Explanation
Port Mode	
switchport trunk allowed vlan {WORD all add WORD except WORD remove WORD} no switchport trunk allowed vlan	Set/delete VLAN allowed to be crossed by Trunk. The "no" command restores the default setting.
switchport trunk native vlan <vlan-id> no switchport trunk native vlan	Set/delete PVID for Trunk port.

6. Set Access port

Command	Explanation

Port Mode	
switchport access vlan <vlan-id> no switchport access vlan	Add the current port to the specified VLAN. The “no” command restores the default setting.

7. Set Hybrid port

Command	Explanation
Port Mode	
switchport hybrid allowed vlan {WORD all add WORD except WORD remove WORD} {tag untag} no switchport hybrid allowed vlan	Set/delete the VLAN which is allowed by Hybrid port with tag or untag mode.
switchport hybrid native vlan <vlan-id> no switchport hybrid native vlan	Set/delete PVID of the port.

8. Disable/Enable VLAN Ingress Rules

Command	Explanation
Port Mode	
vlan ingress enable no vlan ingress enable	Enable/Disable VLAN ingress rules.

9. Configure Private VLAN

Command	Explanation
VLAN mode	
private-vlan {primary isolated community} no private-vlan	Configure current VLAN to Private VLAN. The no command deletes private VLAN.

10. Set Private VLAN association

Command	Explanation
VLAN mode	
private-vlan association <secondary-vlan-list> no private-vlan association	Set/delete Private VLAN association.

11. Specify internal VLAN ID

Command	Explanation
Global mode	
vlan <2-4094> internal	Specify internal VLAN ID.

1.1.3 Typical VLAN Application

Scenario:

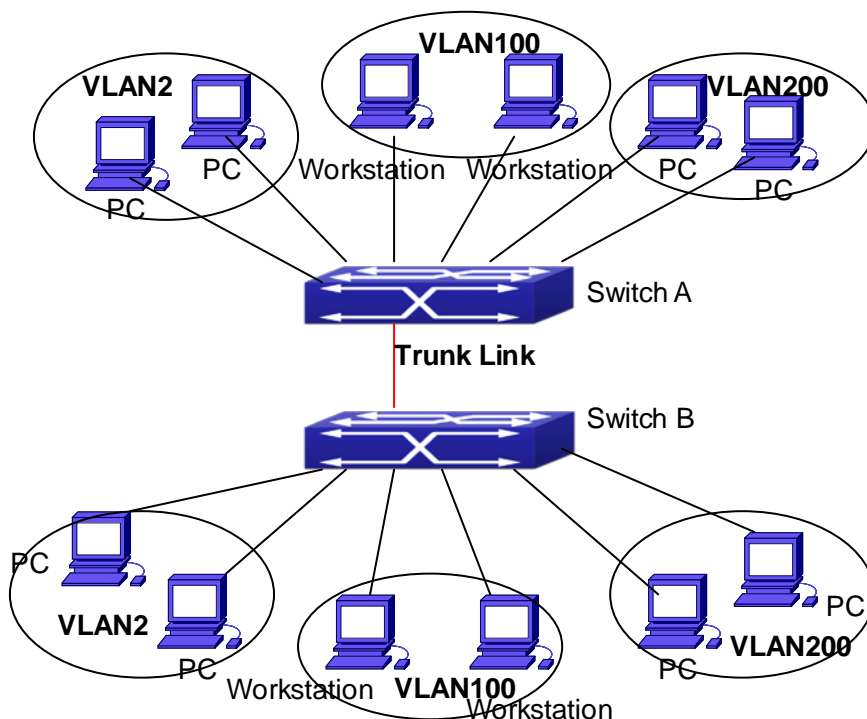

Fig 1-2 Typical VLAN Application Topology

The existing LAN is required to be partitioned to 3 VLANs due to security and application requirements. The three VLANs are VLAN2, VLAN100 and VLAN200. Those three VLANs are cross two different location A and B. One switch is placed in each site, and cross-location requirement can be met if VLAN traffic can be transferred between the two switches.

Configuration Item	Configuration description
VLAN2	Site A and site B switch port 2-4.
VLAN100	Site A and site B switch port 5-7.
VLAN200	Site A and site B switch port 8-10.
Trunk port	Site A and site B switch port 11.

Connect the Trunk ports of both switches for a Trunk link to convey the cross-switch VLAN traffic; connect all network devices to the other ports of corresponding VLANs.

In this example, port 1 and port 12 are spared and can be used for management port or for other purposes.

The configuration steps are listed below:

Switch A:

```
Switch(config)#vlan 2
Switch(Config-Vlan2)#switchport interface ethernet 1/0/2-4
Switch (Config-Vlan2)#exit
Switch (config)#vlan 100
Switch (Config-Vlan100)#switchport interface ethernet 1/0/5-7
Switch (Config-Vlan100)#exit
Switch (config)#vlan 200
Switch (Config-Vlan200)#switchport interface ethernet 1/0/8-10
Switch (Config-Vlan200)#exit
Switch (config)#interface ethernet 1/0/11
Switch (Config-If-Ethernet1/0/11)#switchport mode trunk
Switch(Config-If-Ethernet1/0/11)#exit
Switch(config)#
```

Switch B:

```
Switch(config)#vlan 2
Switch(Config-Vlan2)#switchport interface ethernet 1/0/2-4
Switch (Config-Vlan2)#exit
Switch (config)#vlan 100
Switch (Config-Vlan100)#switchport interface ethernet 1/0/5-7
Switch (Config-Vlan100)#exit
Switch (config)#vlan 200
Switch (Config-Vlan200)#switchport interface ethernet 1/0/8-10
Switch (Config-Vlan200)#exit
Switch (config)#interface ethernet 1/0/11
Switch (Config-If-Ethernet1/0/11)#switchport mode trunk
Switch (Config-If-Ethernet1/0/11)#exit
```

1.1.4 Typical Application of Hybrid Port

Scenario:

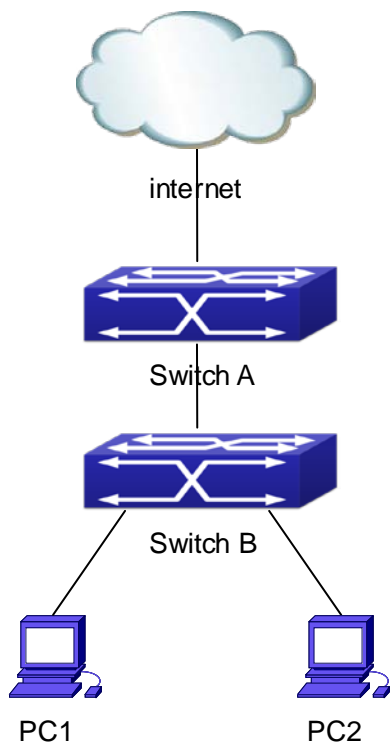

Fig 1-3 Typical Application of Hybrid Port

PC1 connects to the interface Ethernet 1/0/7 of SwitchB, PC2 connects to the interface Ethernet 1/0/9 of SwitchB, Ethernet 1/0/10 of SwitchA connect to Ethernet 1/0/10 of SwitchB.

It is required that PC1 and PC2 can not mutually access due to reason of the security, but PC1 and PC2 can access other network resources through the gateway SwitchA. We can implement this status through Hybrid port.

Configuration items are as follows:

Port	Type	PVID	the VLANs are allowed to pass
Port 1/0/10 of Switch A	Access	10	Allow the packets of VLAN 10 to pass with untag method.
Port 1/0/10 of Switch B	Hybrid	10	Allow the packets of VLAN 7, 9, 10 to pass with untag method.
Port 1/0/7 of Switch B	Hybrid	7	Allow the packets of VLAN 7, 10 to pass with untag method.
Port 1/0/9 of Switch B	Hybrid	9	Allow the packets of VLAN 9, 10 to pass with untag method.

The configuration steps are listed below:

Switch A:

```
Switch(config)#vlan 10
```

```
Switch(Config-Vlan10)#switchport interface ethernet 1/0/10
```

Switch B:

```
Switch(config)#vlan 7;9;10
```

```
Switch(config)#interface ethernet 1/0/7
```

```
Switch(Config-If-Ethernet1/0/7)#switchport mode hybrid
```

```
Switch(Config-If-Ethernet1/0/7)#switchport hybrid native vlan 7
```

```
Switch(Config-If-Ethernet1/0/7)#switchport hybrid allowed vlan 7;10 untag
```

```
Switch(Config-If-Ethernet1/0/7)#exit
```

```
Switch(Config)#interface Ethernet 1/0/9
```

```
Switch(Config-If-Ethernet1/0/9)#switchport mode hybrid
```

```
Switch(Config-If-Ethernet1/0/9)#switchport hybrid native vlan 9
```

```
Switch(Config-If-Ethernet1/0/9)#switchport hybrid allowed vlan 9;10 untag
```

```
Switch(Config-If-Ethernet1/0/9)#exit
```

```
Switch(Config)#interface Ethernet 1/0/10
```

```
Switch(Config-If-Ethernet1/0/10)#switchport mode hybrid
```

```
Switch(Config-If-Ethernet1/0/10)#switchport hybrid native vlan 10
```

```
Switch(Config-If-Ethernet1/0/10)#switchport hybrid allowed vlan 7;9;10 untag
```

```
Switch(Config-If-Ethernet1/0/10)#exit
```

1.2 GVRP Configuration

1.2.1 Introduction to GVRP

GVRP, i.e. GARP VLAN Registration Protocol, is an application of GARP (Generic Attribute Registration Protocol). GARP is mainly used to establish an attribute transmission mechanism to transmit attributes, so as to ensure protocol entities registering and deregistering the attribute. According to different transmission attributes, GARP can be divided to many application protocols, such as GMRP and GVRP. Therefore, GVRP is a protocol which transmits VLAN attributes to the whole layer 2 network through GARP protocol.

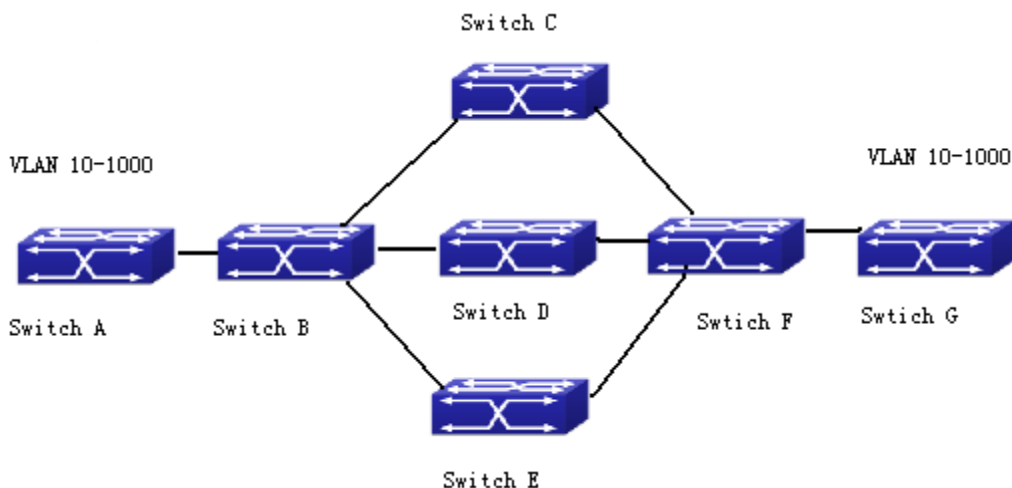

Fig 1-4 a typical application scene

A and G switches are not directly connected in layer 2 network; BCDEF are intermediate switches connecting A and G. Switch A and G configure VLAN100-1000 manually while BCDEF switches do not. When GVRP is not enabled, A and G cannot communicate with each other, because intermediate switches without relevant VLANs. However, after GVRP is enabled on all switches, its VLAN attribute transmission mechanism enables the intermediate switches registering the VLANs dynamically, and the VLAN in VLAN100-1000 of A and G can communicate with each other. The VLANs dynamically registered by intermediate switches will be deregistered when deregistering VLAN100-1000 of A and G switches manually. So the same VLAN of two unadjacent switches can communicate mutually through GVRP protocol instead of configuring each intermediate switch manually for achieving the purpose of simplifying VLAN configuration.

1.2.2 GVRP Configuration Task List

GVRP configuration task list:

1. Configure GVRP timer
2. Configure port type
3. Enable GVRP function

1. Configure GVRP timer

Command	Explanation
Global mode	
garp timer join <200-500> garp timer leave <500-1200> garp timer leaveall <5000-60000> no garp timer (join leave leaveAll)	Configure leaveall, join and leave timer for GVRP.

2. Configure port type

Command	Explanation
Port mode	
gvrp no gvrp	Enable/ disable GVRP function of port.

3. Enable GVRP function

Command	Explanation
Global mode	
gvrp no gvrp	Enable/ disable the global GVRP function of port.

1.2.3 Example of GVRP

GVRP application:

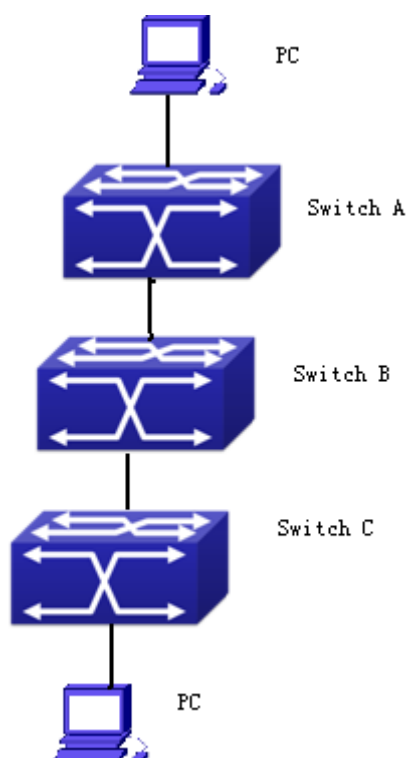

Fig 1-5 Typical GVRP Application Topology

To enable dynamic VLAN information register and update among switches, GVRP

protocol is to be configured in the switch. Configure GVRP in Switch A, B and C, enable Switch B to learn VLAN100 dynamically so that two workstations connected to VLAN100 in Switch A and C can communicate with each other through Switch B without static VLAN100 entries.

Configuration Item	Configuration description
VLAN100	Port 2-6 of Switch A and C.
Trunk port	Port 11 of Switch A and C, Port 10, 11 of Switch B.
Global GVRP	Switch A, B, C.
Port GVRP	Port 11 of Switch A and C, Port 10, 11 of Switch B.

Connect two workstations to the VLAN100 ports in switch A and B, connect port 11 of Switch A to port 10 of Switch B, and port 11 of Switch B to port 11 of Switch C.

The configuration steps are listed below:

Switch A:

```
Switch(config)# gvrp
Switch(config)#vlan 100
Switch(Config-Vlan100)#switchport interface ethernet 1/0/2-6
Switch(Config-Vlan100)#exit
Switch(config)#interface ethernet 1/0/11
Switch(Config-If-Ethernet1/0/11)#switchport mode trunk
Switch(Config-If-Ethernet1/0/11)# gvrp
Switch(Config-If-Ethernet1/0/11)#exit
```

Switch B:

```
Switch(config)#gvrp
Switch(config)#interface ethernet 1/0/10
Switch(Config-If-Ethernet1/0/10)#switchport mode trunk
Switch(Config-If-Ethernet1/0/10)# gvrp
Switch(Config-If-Ethernet1/0/10)#exit
Switch(config)#interface ethernet 1/0/11
Switch(Config-If-Ethernet1/0/11)#switchport mode trunk
Switch(Config-If-Ethernet1/0/11)# gvrp
Switch(Config-If-Ethernet1/0/11)#exit
```

Switch C:

```
Switch(config)# gvrp
```

```
Switch(config)#vlan 100
Switch(Config-Vlan100)#switchport interface ethernet 1/0/2-6
Switch(Config-Vlan100)#exit
Switch(config)#interface ethernet 1/0/11
Switch(Config-If-Ethernet1/0/11)#switchport mode trunk
Switch(Config-If-Ethernet1/0/11)# gvrp
Switch(Config-If-Ethernet1/0/11)#exit
```

1.2.4 GVRP Troubleshooting

The GARP counter setting for Trunk ports in both ends of Trunk link must be the same, otherwise GVRP will not work normally. It is recommended to avoid enabling GVRP and RSTP at the same time in switch. If GVRP needs to be enabled, RSTP function for the ports must be disabled first.

1.3 Dot1q-tunnel Configuration

1.3.1 Introduction to Dot1q-tunnel

Dot1q-tunnel is also called QinQ (802.1Q-in-802.1Q), which is an expansion of 802.1Q. Its dominating idea is encapsulating the customer VLAN tag (CVLAN tag) to the service provider VLAN tag (SPVLAN tag). Carrying the two VLAN tags the packet is transmitted through the backbone network of the ISP internet, so to provide a simple layer-2 tunnel for the users. It is simple and easy to manage, applicable only by static configuration, and especially adaptive to small office network or small scale metropolitan area network using layer-3 switch as backbone equipment.

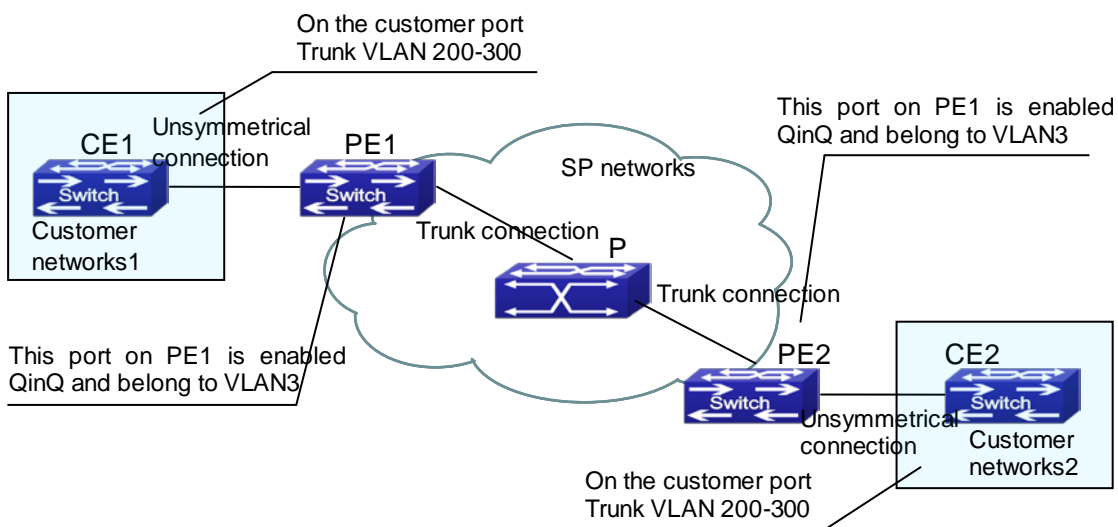

Fig 1-6 Dot1q-tunnel based Internetworking mode

As shown in above, after being enabled on the user port, dot1q-tunnel assigns each user an SPVLAN identification (SPVID). Here the identification of user is 3. Same SPVID should be assigned for the same network user on different PEs. When packet reaches PE1 from CE1, it carries the VLAN tag 200-300 of the user internal network. Since the dot1q-tunnel function is enabled, the user port on PE1 will add on the packet another VLAN tag, of which the ID is the SPVID assigned to the user. Afterwards, the packet will only be transmitted in VLAN3 when traveling in the ISP internet network while carrying two VLAN tags (the inner tag is added when entering PE1, and the outer is SPVID), whereas the VLAN information of the user network is open to the provider network. When the packet reaches PE2 and before being forwarded to CE2 from the client port on PE2, the outer VLAN tag is removed, then the packet CE2 receives is absolutely identical to the one sent by CE1. For the user, the role the operator network plays between PE1 and PE2, is to provide a reliable layer-2 link.

The technology of Dot1q-tunnel provides the ISP internet the ability of supporting many client VLANs by only one VLAN of theirselves. Both the ISP internet and the clients can configure their own VLAN independently.

It is obvious that, the dot1q-tunnel function has got following characteristics:

- ☞ Applicable through simple static configuration, no complex configuration or maintenance to be needed.
- ☞ Operators will only have to assign one SPVID for each user, which increases the number of concurrent supportable users; while the users has got the ultimate freedom in selecting and managing the VLAN IDs (select within 1~4096 at users' will).
- ☞ The user network is considerably independent. When the ISP internet is upgrading their network, the user networks do not have to change their original configuration.

Detailed description on the application and configuration of dot1q-tunnel will be provided in this section.

1.3.2 Dot1q-tunnel Configuration

Configuration Task Sequence of Dot1q-Tunnel:

1. Configure the dot1q-tunnel function on port
2. Configure the protocol type (TPID) on port

1. Configure the dot1q-tunnel function on port

Command	Explanation
---------	-------------

Port mode	
dot1q-tunnel enable no dot1q-tunnel enable	Enter/exit the dot1q-tunnel mode on the port.

2. Configure the protocol type (TPID) on port

Command	Explanation
Port mode	
dot1q-tunnel tpid {0x8100 0x9100 0x9200 <1-65535>}	Configure the protocol type on TRUNK port.

1.3.3 Typical Applications of the Dot1q-tunnel

Scenario:

Edge switch PE1 and PE2 of the ISP internet forward the VLAN200~300 data between CE1 and CE2 of the client network with VLAN3. The port1 of PE1 is connected to CE1, port10 is connected to public network, the TPID of the connected equipment is 9100; port1 of PE2 is connected to CE2, port10 is connected to public network.

Configuration Item	Configuration Explanation
VLAN3	Port1 of PE1 and PE2.
dot1q-tunnel	Port1 of PE1 and PE2.
tpid	9100

Configuration procedure is as follows:

PE1:

```
Switch(config)#vlan 3
Switch(Config-Vlan3)#switchport interface ethernet 1/0/1
Switch(Config-Vlan3)#exit
Switch(Config)#interface ethernet 1/0/1
Switch(Config-Ethernet1/0/1)# dot1q-tunnel enable
Switch(Config-Ethernet1/0/1)# exit
Switch(Config)#interface ethernet 1/0/10
Switch(Config-Ethernet1/0/10)#switchport mode trunk
Switch(Config-Ethernet1/0/10)#dot1q-tunnel tpid 0x9100
Switch(Config-Ethernet1/0/10)#exit
Switch(Config)#
```

PE2:

```
Switch(config)#vlan 3
Switch(Config-Vlan3)#switchport interface ethernet 1/0/1
Switch(Config-Vlan3)#exit
Switch(Config)#interface ethernet 1/0/1
Switch(Config-Ethernet1/0/1)# dot1q-tunnel enable
Switch(Config-Ethernet1/0/1)# exit
Switch(Config)#interface ethernet 1/0/10
Switch(Config-Ethernet1/0/10)#switchport mode trunk
Switch(Config-Ethernet1/0/10)#dot1q-tunnel tpid 0x9100
Switch(Config-Ethernet1/0/10)#exit
Switch(Config)#
```

1.3.4 Dot1q-tunnel Troubleshooting

- ☞ Enabling dot1q-tunnel on Trunk port will make the tag of the data packet unpredictable which is not required in the application. So it is not recommended to enable dot1q-tunnel on Trunk port.
 - ☞ Enabled with STP/MSTP is not supported.
- Enabled with PVLAN is not supported.

1.4 VLAN-translation Configuration

1.4.1 Introduction to VLAN-translation

VLAN translation, as one can tell from the name, which translates the original VLAN ID to new VLAN ID according to the user requirements so to exchange data across different VLANs. VLAN translation is classified to ingress translation and egress translation, respectively switch over the VLAN ID at the ingress or the egress.

Application and configuration of VLAN translation will be explained in detail in this section.

1.4.2 VLAN-translation Configuration

Configuration task sequence of VLAN-translation:

1. Configure the VLAN-translation function on the port
2. Configure the VLAN-translation relations on the port
3. Configure whether the packet is dropped when checking VLAN-translation is failing

4. Show the related configuration of vlan-translation

1. Configure the VLAN-translation of the port

Command	Explanation
Port mode	
vlan-translation enable no vlan-translation enable	Enter/exit the port VLAN-translation mode.

2. Configure the VLAN-translation relation of the port

Command	Explanation
Port mode	
vlan-translation <old-vlan-id> to <new-vlan-id> {in out} no vlan-translation old-vlan-id {in out}	Add/delete a VLAN-translation relation.

3. Configure whether the packet is dropped when checking VLAN-translation is failing

Command	Explanation
Port mode	
vlan-translation miss drop {in out both} no vlan-translation miss drop {in out both}	Configure the VLAN-translation packet dropped on port if there is any failure.

4. Show the related configuration of vlan-translation

Command	Explanation
Admin mode	
show vlan-translation	Show the related configuration of vlan-translation.

1.4.3 Typical application of VLAN-translation

Scenario:

Edge switch PE1 and PE2 of the ISP internet support the VLAN20 data task between CE1 and CE2 of the client network with VLAN3. The port1/0/1 of PE1 is connected to CE1,

port1/0/10 is connected to public network; port1/0/1 of PE2 is connected to CE2, port1/0/10 is connected to public network.

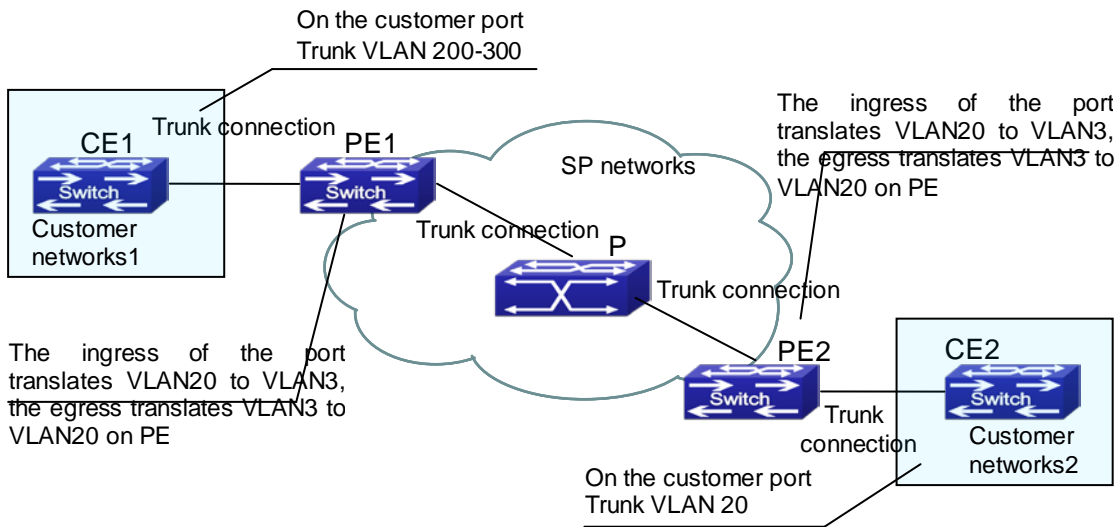

Fig 1-7 Vlan translation topology mode

Configuration Item	Configuration Explanation
VLAN-translation	Port1/0/1 of PE1 and PE2.
Trunk port	Port1/0/1 and Port1/0/10 of PE1 and PE2.

Configuration procedure is as follows:

PE1、PE2:

```

switch(Config)#interface ethernet 1/0/1
switch(Config-Ethernet1/0/1)#switchport mode trunk
switch(Config-Ethernet1/0/1)# vlan-translation enable
switch(Config-Ethernet1/0/1)# vlan-translation 20 to 3 in
switch(Config-Ethernet1/0/1)# vlan-translation 3 to 20 out
switch(Config-Ethernet1/0/1)# exit
switch(Config)#interface ethernet 1/0/10
switch(Config-Ethernet1/0/10)#switchport mode trunk
switch(Config-Ethernet1/0/10)#exit
switch(Config)#
    
```

1.4.4 VLAN-translation Troubleshooting

Normally the VLAN-translation is applied on trunk ports.

Normally before using the VLAN-translation, the dot1q-tunnel function needs to be enabled first, to adapt double tag data packet processes VLAN-translation.

1.5 Dynamic VLAN Configuration

1.5.1 Introduction to Dynamic VLAN

The dynamic VLAN is named corresponding to the static VLAN (namely the port based VLAN). Dynamic VLAN supported by the switch includes MAC-based VLAN, IP-subnet-based VLAN and Protocol-based VLAN. Detailed description is as follows:

The MAC-based VLAN division is based on the MAC address of each host, namely every host with a MAC address will be assigned to certain VLAN. By the means, the network user will maintain his membership in his belonging VLAN when moves from a physical location to another. As we can see the greatest advantage of this VLAN division is that the VLAN does not have to be re-configured when the user physical location change, namely shift from one switch to another, which is because it is user based, not switch port based.

The IP subnet based VLAN is divided according to the source IP address and its subnet mask of every host. It assigns corresponding VLAN ID to the data packet according to the subnet segment, leading the data packet to specified VLAN. Its advantage is the same as that of the MAC-based VLAN: the user does not have to change configuration when relocated.

The VLAN is divided by the network layer protocol, assigning different protocol to different VLANs. This is very attractive to the network administrators who wish to organize the user by applications and services. Moreover the user can move freely within the network while maintaining his membership. Advantage of this method enables user to change physical position without changing their VLAN residing configuration, while the VLAN can be divided by types of protocols which is important to the network administrators. Further, this method has no need of added frame label to identify the VLAN which reduce the network traffic.

Notice: Dynamic VLAN needs to associate with Hybrid attribute of the ports to work, so the ports that may be added to a dynamic VLAN must be configured as Hybrid port.

1.5.2 Dynamic VLAN Configuration

Dynamic VLAN Configuration Task Sequence:

1. Configure the MAC-based VLAN function on the port
2. Set the VLAN to MAC VLAN

3. Configure the correspondence between the MAC address and the VLAN
4. Configure the IP-subnet-based VLAN function on the port
5. Configure the correspondence between the IP subnet and the VLAN
6. Configure the correspondence between the Protocols and the VLAN
7. Adjust the priority of the dynamic VLAN

1. Configure the MAC-based VLAN function on the port

Command	Explanation
Port Mode	
switchport mac-vlan enable no switchport mac-vlan enable	Enable/disable the MAC-based VLAN function on the port.

2. Set the VLAN to MAC VLAN

Command	Explanation
Global Mode	
mac-vlan vlan <vlan-id> no mac-vlan	Configure the specified VLAN to MAC VLAN; the “no mac-vlan” command cancels the MAC VLAN configuration of this VLAN.

3. Configure the correspondence between the MAC address and the VLAN

Command	Explanation
Global Mode	
mac-vlan mac <mac-addrss> <mac-mask> vlan <vlan-id> priority <priority-id> no mac-vlan {mac <mac-addrss> <mac-mask> all}	Add/delete the correspondence between the MAC address and the VLAN, it means to make the specified MAC address join/leave the specified VLAN.

4. Configure the IP-subnet-based VLAN function on the port

Command	Explanation
Port Mode	
switchport subnet-vlan enable no switchport subnet-vlan enable	Enable/disable the port IP-subnet-base VLAN function on the port.

5. Configure the correspondence between the IP subnet and the VLAN

Command	Explanation
Global Mode	
subnet-vlan ip-address <ipv4-addrss> mask <subnet-mask> vlan <vlan-id> priority <priority-id> no subnet-vlan {ip-address <ipv4-addrss> mask <subnet-mask> all}	Add/delete the correspondence between the IP subnet and the VLAN, namely specified IP subnet joins/leaves specified VLAN.

6. Configure the correspondence between the Protocols and the VLAN

Command	Explanation
Global Mode	
protocol-vlan mode {ethernetii etype <etype-id> llc {dsap <dsap-id> ssap <ssap-id>} snap etype <etype-id>} vlan <vlan-id> priority <priority-id> no protocol-vlan {mode {ethernetii etype <etype-id> llc {dsap <dsap-id> ssap <ssap-id>} snap etype <etype-id>} all}	Add/delete the correspondence between the Protocols and the VLAN, namely specified protocol joins/leaves specified VLAN.

7. Adjust the priority of the dynamic VLAN

Command	Explanation
Global Mode	
dynamic-vlan mac-vlan prefer dynamic-vlan subnet-vlan prefer	Configure the priority of the dynamic VLAN.

1.5.3 Typical Application of the Dynamic VLAN

Scenario:

In the office network Department A belongs to VLAN100. Several members of this department often have the need to move within the whole office network. It is also required to ensure the resource for other members of the department to access VLAN 100. Assume one of the members is M, the MAC address of his PC is 00-03-0f-11-22-33, when M moves to VLAN200 or VLAN300, the port connecting M is configured as Hybrid mode and belongs to VLAN100 with untag mode. In this way, the data of VLAN100 will be forwarded to the port connecting M, and implement the communication requirement in VLAN100.

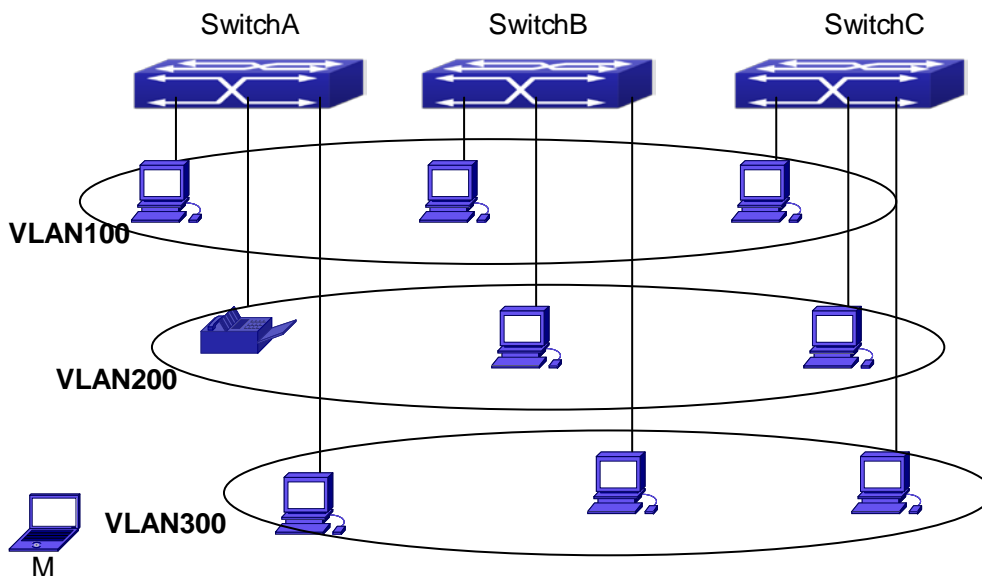

Fig 1-8 Typical topology application of dynamic VLAN

Configuration Items	Configuration Explanation
MAC-based VLAN	Global configuration on Switch A, Switch B, Switch C.

For example, M at E1/0/1 of SwitchA, then the configuration procedures are as follows:

Switch A, Switch B, Switch C:

```
SwitchA (Config)#mac-vlan mac 00-03-0f-11-22-33 vlan 100 priority 0
```

```
SwitchA (Config)#interface ethernet 1/0/1
```

```
SwitchA (Config-Ethernet1/0/1)# swportport mode hybrid
```

```
SwitchA (Config-Ethernet1/0/1)# swportport hybrid allowed vlan 100 untagged
```

```
SwitchB (Config)#mac-vlan mac 00-03-0f-11-22-33 vlan 100 priority 0
```

```
SwitchB (Config)#exit
```

```
SwitchB#
```

```
SwitchC (Config)#mac-vlan mac 00-03-0f-11-22-33 vlan 100 priority 0
```

```
SwitchC (Config)#exit
```

```
SwitchC#
```

1.5.4 Dynamic VLAN Troubleshooting

☞ On the switch configured with dynamic VLAN, if the two connected equipment (e.g.

PC) are both belongs to the same dynamic VLAN, first communication between the two equipments may not go through. The solution will be letting the two equipments positively send data packet to the switch (such as ping), to let the switch learn their source MAC, then the two equipments will be able to communicate freely within the dynamic VLAN.

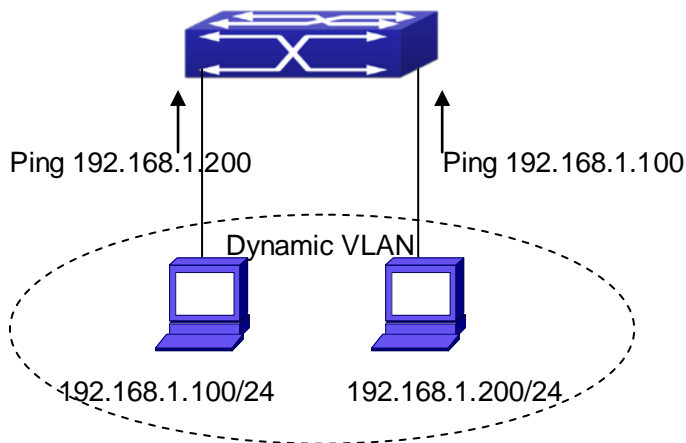

Fig 1-9 Dynamic VLAN Troubleshooting

1.6 Voice VLAN Configuration

1.6.1 Introduction to Voice VLAN

Voice VLAN is specially configured for the user voice data traffic. By setting a Voice VLAN and adding the ports of the connected voice equipments to the Voice VLAN, the user will be able to configure QoS (Quality of service) service for voice data, and improve the voice data traffic transmission priority to ensure the calling quality.

The switch can judge if the data traffic is the voice data traffic from specified equipment according to the source MAC address field of the data packet entering the port. The packet with the source MAC address complying with the system defined voice equipment OUI (Organizationally Unique Identifier) will be considered the voice data traffic and transmitted to the Voice VLAN.

The configuration is based on MAC address, acquiring a mechanism in which every voice equipment transmitting information through the network has got its unique MAC address. VLAN will trace the address belongs to specified MAC. By This means, VLAN allows the voice equipment always belong to Voice VLAN when relocated physically. The greatest advantage of the VLAN is the equipment can be automatically placed into Voice VLAN according to its voice traffic which will be transmitted at specified priority. Meanwhile, when voice equipment is physically relocated, it still belongs to the Voice VLAN without

any further configuration modification, which is because it is based on voice equipment other than switch port.

Notice: Voice VLAN needs to associate with Hybrid attribute of the ports to work, so the ports that may be added to Voice VLAN must be configured as Hybrid port.

1.6.2 Voice VLAN Configuration

Voice VLAN Configuration Task Sequence:

1. Set the VLAN to Voice VLAN
2. Add a voice equipment to Voice VLAN
3. Enable the Voice VLAN on the port

1. Configure the VLAN to Voice VLAN

Command	Explanation
Global Mode	
voice-vlan vlan <vlan-id> no voice-vlan	Set/cancel the VLAN as a Voice VLAN

2. Add a Voice equipment to a Voice VLAN

Command	Explanation
Global Mode	
voice-vlan mac <mac-address> <mac-address-mask> priority <priority-id> [name <voice-name>] no voice-vlan {mac <mac-address> <mac-address-mask> name <voice-name> all}	Specify certain voice equipment join/leave the Voice VLAN

3. Enable the Voice VLAN of the port

Command	Explanation
Port Mode	
switchport voice-vlan enable no switchport voice-vlan enable	Enable/disable the Voice VLAN function on the port

1.6.3 Typical Applications of the Voice VLAN

Scenario:

A company realizes voice communication through configuring Voice VLAN. IP-phone1 and IP-phone2 can be connected to any port of the switch, namely normal communication and interconnected with other switches through the uplink port. IP-phone1 MAC address is 00-03-0f-11-22-33, connect port 1/0/1 of the switch, IP-phone2 MAC address is 00-03-0f-11-22-55, connect port 1/0/2 of the switch.

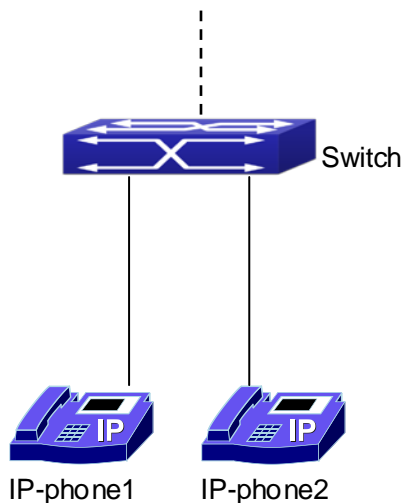

Fig 1-10 VLAN typical apply topology Figure

Configuration items	Configuration Explanation
Voice VLAN	Global configuration on the Switch.

Configuration procedure:

Switch 1:

```
Switch(config)#vlan 100
Switch(Config-Vlan100)#exit
Switch(config)#voice-vlan vlan 100
Switch(config)#voice-vlan mac 00-03-0f-11-22-33 mask 255 priority 5 name company
Switch(config)#voice-vlan mac 00-03-0f-11-22-55 mask 255 priority 5 name company
Switch(config)#interface ethernet 1/0/10
Switch(Config-If-Ethernet1/0/10)#switchport mode trunk
Switch(Config-If-Ethernet1/0/10)#exit
switch(Config)#interface ethernet 1/0/1
switch(Config-If-Ethernet1/0/1)#switchport mode hybrid
switch(Config-If-Ethernet1/0/1)#switchport hybrid allowed vlan 100 untag
switch(Config-If-Ethernet1/0/1)#exit
switch(Config)#interface ethernet 1/0/2
```

```
switch(Config-If-Ethernet1/0/2)#switchport mode hybrid
switch(Config-If-Ethernet1/0/2)#switchport hybrid allowed vlan 100 untag
switch(Config-If-Ethernet1/0/2)#exit
```

1.6.4 Voice VLAN Troubleshooting

Voice VLAN can not be applied concurrently with MAC-base VLAN. The Voice VLAN support maximum 1024 sets of voice equipments, the exceeded number of equipments will not be supported.

- ☞ The Voice VLAN on the port is enabled by default. If the configured data can no longer enter the Voice VLAN during operation, please check if the Voice VLAN function has been disabled on the port.

1.7 Super VLAN Configuration

1.7.1 Introduction to Super VLAN

Super VLAN, also called VLAN aggregation, we introduce the notion of super VLAN and sub VLAN. One or more sub VLANs belong to a super VLAN, and sub VLAN does not occupy an absolute subnet segment any more. However, in the same super VLAN, whether host belongs to any sub VLAN, its IP address is within the subnet segment associated with super VLAN.

In LanSwitch network, VLAN technique is applied widely for advantages (flexible control of broadcast domain and deploy convenience). However, in generic layer-3 switch, it implements communication between broadcast domains through a method that a VLAN correspond to a layer-3 interface, it results in IP address waste.

For example, VLAN division of device is shown in the figure.

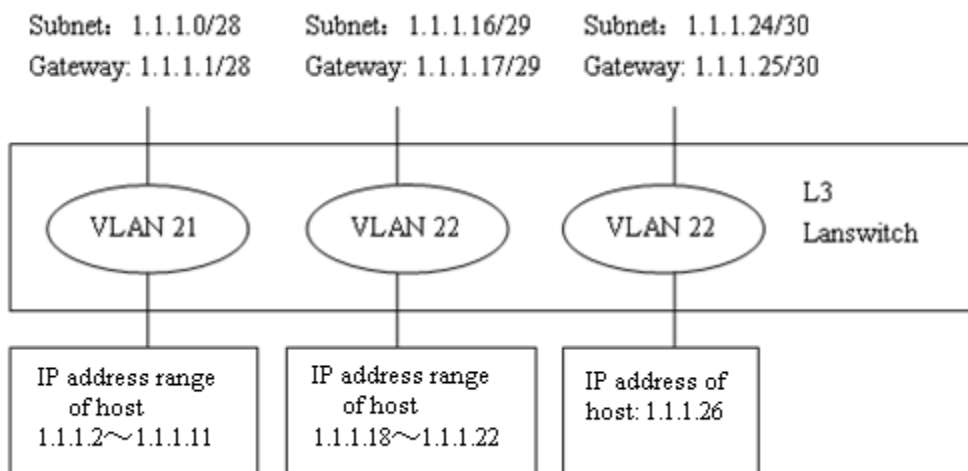

Fig 1-11 generic VLAN network

VLAN	IP Subnet	Gateway Address	Usable Hosts	Customer Hosts	Needed Hosts
21	1.1.1.0/28	1.1.1.1	14	13	10
22	1.1.1.16/29	1.1.1.17	6	5	5
23	1.1.1.24/30	1.1.1.25	2	1	1

Tab 1-1 host address division of generic VLAN

In above table, the needed hosts may be 10 in VLAN 21 and assign a subnet with mask of 28 bits—1.1.1.0/28. However, subnet 1.1.1.0 of network segment, subnet broadcast address 1.1.1.15 and the default gateway address 1.1.1.1 can not become the host address, address range within 1.1.1.2 to 1.1.1.14 can become the host address. So the usable host addresses total is 13 ($2^{32-28}-3=13$), however, only 10 addresses can satisfy the requirement for VLAN21.

The rest may be deduced by analogy, the needed host addresses is 5 for VLAN 22. To satisfy request, it needs to assign a subnet with mask of 29 bits (1.1.1.16/29) for VLAN 22. The needed host address is only 1 for VLAN 23, but it occupies subnet 1.1.1.24/30.

The needed addresses is 16 (10+5+1) for three VLANs, but the excellent method also occupies 28 addresses ($2^{32-28}+2^{32-29}+2^{32-30}=28$) according to address division of generic VLAN, so waste many addresses. Besides, if the needed hosts only reach to 3, but not to 10 hosts, and a subnet with mask of 28 bits is assigned to VLAN 21 before, here, the redundant addresses are wasted because they can not be used by other VLAN.

The above division is difficult to network update. If client of VLAN23 needs to add 2 hosts and client does not want to change the assigned IP address, but the addresses after 1.1.1.24 are assigned to others, so we should assign a subnet with mask of 29 bits and a new VLAN to this client. Here, there are 3 hosts for client of VLAN23 only, but this client is assigned two subnets (they are not in the same VLAN), therefore, it is difficult to management.

We can see that the number of the wasting IP address (such as subnet number, broadcast address, default gateway address) is considerable and badly reduce the addressing flexibility that waste many addresses. Therefore, Super VLAN is developed for solving the problem.

Super VLAN advantages are shown in the following:

Reduce IP address number about subnet number, default gateway address and broadcast address

Implement that the different broadcast domains use addresses of the same subnet

segment

Enhance addressing flexibility

Reduce the address waste

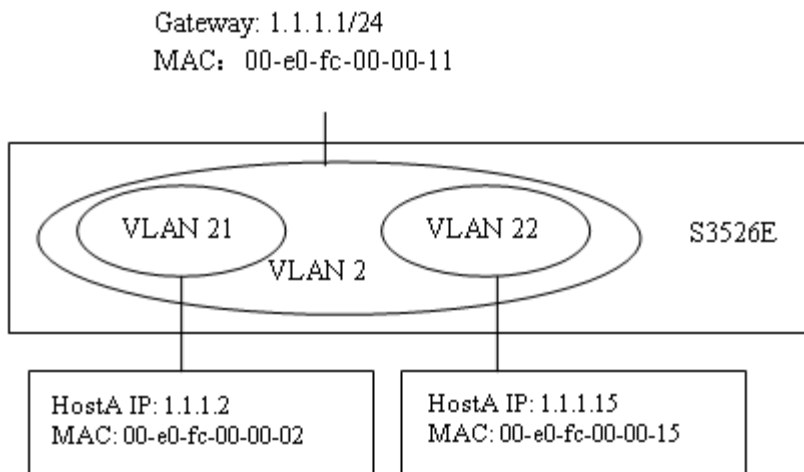

Fig 1-12 super vlan function

Super VLAN is different to the generic VLAN. Super VLAN only create a layer-3 interface and does not include any ports, is a layer-3 notion.

Layer-3 interface of super VLAN is also at UP state as long as there is physical port is at UP state in its sub-VLAN.

1.7.2 Super VLAN Configuration

1. Create or delete supervlan
2. Specify or delete subvlan
3. Enable or disable arp-proxy function of subvlan
4. Specify or delete ip-addr-range of interface
5. Specify or delete ip-addr-range of subvlan

1. Create or delete supervlan

Command	Explanation
VLAN configuration mode	
supervlan no supervlan	Create or delete supervlan.

2. Specify or delete subvlan

Command	Explanation
VLAN configuration mode	

subvlan WORD no subvlan {WORD all}	Specify or delete subvlan.
---	----------------------------

3. Enable or disable arp-proxy function of subvlan

Command	Explanation
Interface configuration mode	
arp-proxy subvlan {WORD all} no arp-proxy subvlan {WORD all}	Enable or disable arp-proxy function of subvlan.

4. Specify or delete ip-addr-range of interface

Command	Explanation
Interface configuration mode	
ip-addr-range <ipv4-addrss> to <ipv4-addrss> no ip-addr-range	Specify or delete address range of interface.

5. Specify or delete ip-addr-range of subvlan

Command	Explanation
Interface configuration mode	
ip-addr-range subvlan <vlan-id> <ipv4-addrss> to <ipv4-addrss> no ip-addr-range subvlan <vlan-id>	Specify or delete address range of subvlan.

1.7.3 Typical Application of Super VLAN

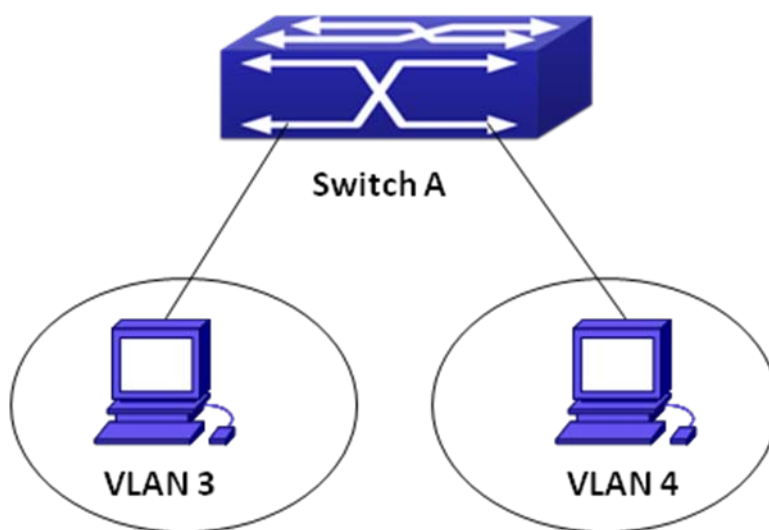

Fig 1-13 typical of super vlan topology

Terminals of two VLANs need to configure their addresses in the same network segment due to requirement of LAN application. Layer-2 flows need to be isolated, but layer-3 flows can be forwarded normally between two terminals. Address range of VLAN3 from 1.1.1.1 to 1.1.1.10, address range of VLAN4 from 1.1.1.20 to 1.1.1.30, layer-3 flows of terminals within two address ranges allow to be forwarded only. To implement this requirement, it needs to configure supervlan on switch.

Configuration items	Configuration Explanation
VLAN2	Supervlan
VLAN3	Port1 of switchA
VLAN4	Port2 of switchA

Configuration procedure:

Switch A:

```
switch(Config)#vlan 2-4
switch(Config)#vlan 2
switch(Config-Vlan2)#supervlan
switch(Config-Vlan2)#subvlan 3;4
switch(Config-Vlan2)#exit
switch(Config)#interface vlan 2
switch(config-if-vlan2)#ip address 1.1.1.254 255.255.255.0
switch(config-if-vlan2)#arp-proxy subvlan all
switch(config-if-vlan2)#ip-addr-range subvlan 3 1.1.1.1 to 1.1.1.10
switch(config-if-vlan2)#ip-addr-range subvlan 4 1.1.1.20 to 1.1.1.30
switch(config-if-vlan2)#exit
```

1.7.4 Super VLAN Troubleshooting

- ☞ Supervlan and these functions (VRRP, dynamic VLAN, private VLAN, multicast VLAN, etc.) are mutually exclusive, so they should not be used at the same time.
- ☞ arp-proxy of subvlan takes effect to only one subvlan. Flow received by VLAN with arp-proxy can be forwarded to other VLAN. When two devices send flows to each other at different subvlan, please enable arp-proxy function on two subvlans.
- ☞ Sub vlan can not set layer-3 interface.
- ☞ When creating/deleting supervlan, VLAN needs to ensure no layer-3 interface, if not, it will result in error.
- ☞ If interface of supervlan specifies IP address range, but do not specify address range

of subvlan, address range set by interface is standard. If both interface and subvlan specify IP address range, please check whether packets are within subvlan address range firstly, second, check whether packets are within interface address range. After that, packets can be processed other operations.

- ☞ When setting supervlan or subvlan, VLAN must be exist, it can be set.
- ☞ When port mode is set as trunk, it will automatically filter supervlan from allow-vlan.

Chapter 2 MAC Table Configuration

2.1 Introduction to MAC Table

MAC table is a table identifies the mapping relationship between destination MAC addresses and switch ports. MAC addresses can be categorized as static MAC addresses and dynamic MAC addresses. Static MAC addresses are manually configured by the user, have the highest priority and are permanently effective (will not be overwritten by dynamic MAC addresses); dynamic MAC addresses are entries learnt by the switch in data frame forwarding, and is effective for a limited period. When the switch receives a data frame to be forwarded, it stores the source MAC address of the data frame and creates a mapping to the destination port. Then the MAC table is queried for the destination MAC address, if hit, the data frame is forwarded in the associated port, otherwise, the switch forwards the data frame to its broadcast domain. If a dynamic MAC address is not learnt from the data frames to be forwarded for a long time, the entry will be deleted from the switch MAC table.

There are two MAC table operations:

1. Obtain a MAC address.
2. Forward or filter data frame according to the MAC table.

2.1.1 Obtaining MAC Table

The MAC table can be built up statically and dynamically. Static configuration is to set up a mapping between the MAC addresses and the ports; dynamic learning is the process in which the switch learns the mapping between MAC addresses and ports, and updates the MAC table regularly. In this section, we will focus on the dynamic learning process of MAC table.

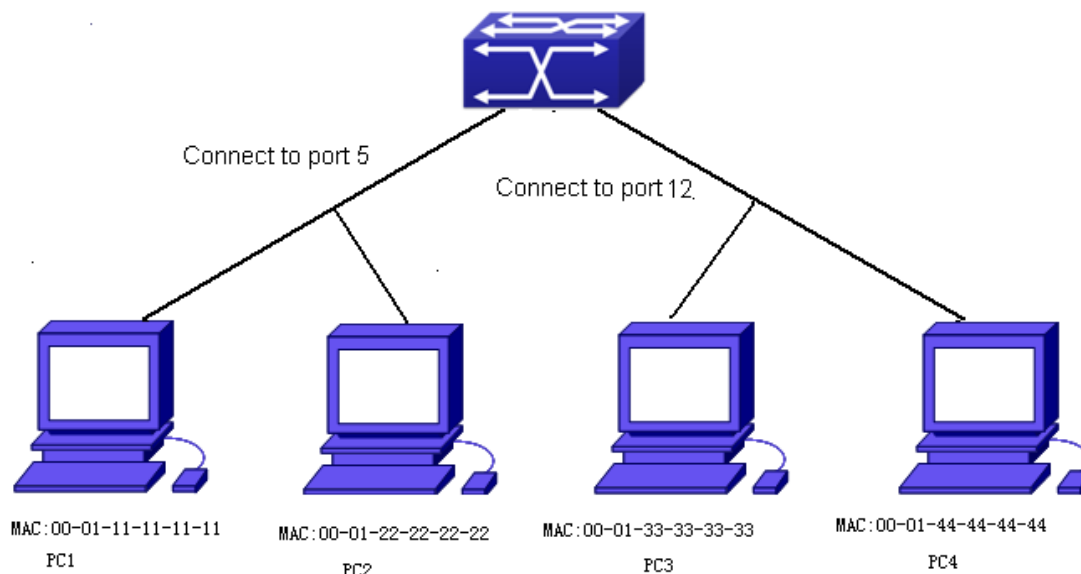

Fig 2-1 MAC Table dynamic learning

The topology of the figure above: 4 PCs connected to switch, where PC1 and PC2 belongs to a same physical segment (same collision domain), the physical segment connects to port 1/0/5 of switch; PC3 and PC4 belongs to the same physical segment that connects to port 1/0/12 of switch.

The initial MAC table contains no address mapping entries. Take the communication of PC1 and PC3 as an example, the MAC address learning process is as follow:

1. When PC1 sends message to PC3, the switch receives the source MAC address 00-01-11-11-11-11 from this message, the mapping entry of 00-01-11-11-11-11 and port 1/0/5 is added to the switch MAC table.
2. At the same time, the switch learns the message is destined to 00-01-33-33-33-33, as the MAC table contains only a mapping entry of MAC address 00-01-11-11-11-11 and port 1/0/5, and no port mapping for 00-01-33-33-33-33 present, the switch broadcast this message to all the ports in the switch (assuming all ports belong to the default VLAN1).
3. PC3 and PC4 on port 1/0/12 receive the message sent by PC1, but PC4 will not reply, as the destination MAC address is 00-01-33-33-33-33, only PC3 will reply to PC1. When port 1/0/12 receives the message sent by PC3, a mapping entry for MAC address 00-01-33-33-33-33 and port 1/0/12 is added to the MAC table.
4. Now the MAC table has two dynamic entries, MAC address 00-01-11-11-11-11 - port 1/0/5 and 00-01-33-33-33-33 - port 1/0/12.
5. After the communication between PC1 and PC3, the switch does not receive any message sent from PC1 and PC3. And the MAC address mapping entries in the MAC table are deleted in 300 to 2*300 seconds (ie, in single to double aging time). The 300

seconds here is the default aging time for MAC address entry in switch. Aging time can be modified in switch.

2.1.2 Forward or Filter

The switch will forward or filter received data frames according to the MAC table. Take the above figure as an example, assuming switch have learnt the MAC address of PC1 and PC3, and the user manually configured the mapping relationship for PC2 and PC4 to ports. The MAC table of switch will be:

MAC Address	Port number	Entry added by
00-01-11-11-11-11	1/0/5	Dynamic learning
00-01-22-22-22-22	1/0/5	Static configuration
00-01-33-33-33-33	1/0/12	Dynamic learning
00-01-44-44-44-44	1/0/12	Static configuration

1. Forward data according to the MAC table

If PC1 sends a message to PC3, the switch will forward the data received on port 1/0/5 from port 1/0/12.

2. Filter data according to the MAC table

If PC1 sends a message to PC2, the switch, on checking the MAC table, will find PC2 and PC1 are in the same physical segment and filter the message (i.e. drop this message).

Three types of frames can be forwarded by the switch:

- ☞ Broadcast frame
- ☞ Multicast frame
- ☞ Unicast frame

The following describes how the switch deals with all the three types of frames:

1. Broadcast frame: The switch can segregate collision domains but not broadcast domains. If no VLAN is set, all devices connected to the switch are in the same broadcast domain. When the switch receives a broadcast frame, it forwards the frame in all ports. When VLANs are configured in the switch, the MAC table will be adapted accordingly to add VLAN information. In this case, the switch will not forward the received broadcast frames in all ports, but forward the frames in all ports in the same VLAN.
2. Multicast frame: For the unknown multicast, the switch will broadcast it in the same vlan, but the switch only forwards the multicast frames to the multicast group's port if IGMP Snooping function or the static multicast group has been configured.
3. Unicast frame: When no VLAN is configured, if the destination MAC addresses

are in the switch MAC table, the switch will directly forward the frames to the associated ports; when the destination MAC address in a unicast frame is not found in the MAC table, the switch will broadcast the unicast frame. When VLANs are configured, the switch will forward unicast frame within the same VLAN. If the destination MAC address is found in the MAC table but belonging to different VLANs, the switch can only broadcast the unicast frame in the VLAN it belongs to.

2.2 Mac Address Table Configuration Task List

1. Configure the MAC address aging-time
2. Configure static MAC forwarding or filter entry
3. Clear dynamic address table
4. Configure MAC learning through CPU control
5. Configure the hash collision mac table

1. Configure the MAC aging-time

Command	Explanation
Global Mode	
mac-address-table aging-time <0/aging-time> no mac-address-table aging-time	Configure the MAC address aging-time.

2. Configure static MAC forwarding or filter entry

Command	Explanation
Global Mode	
mac-address-table {static static-multicast blackhole} address <mac-addr> vlan <vlan-id > [interface [ethernet portchannel] <interface-name>] [source destination both] no mac-address-table {static static-multicast blackhole dynamic} [address <mac-addr>] [vlan <vlan-id>] [interface [ethernet portchannel] <interface-name>]	Configure static MAC entries, static multicast MAC entries, filter address entries.

3. Clear dynamic address table

Command	Explanation
Admin Mode	
clear mac-address-table dynamic [address <mac-addr>] [vlan <vlan-id>] [interface [ethernet portchannel] <interface-name>]	Clear the dynamic address table.

4. Configure MAC learning through CPU control

Command	Explanation
Global Mode	
mac-address-learning cpu-control no mac-address-learning cpu-control	Enable MAC learning through CPU control, the no command restores that the chip automatically learn MAC address.

5. Configure the hash collision mac table

Command	Explanation
Global Mode	
show collision-mac-address-table	Show the hash collision mac table.
Admin Mode	
clear collision-mac-address-table	Clear the hash collision mac table.

2.3 Typical Configuration Examples

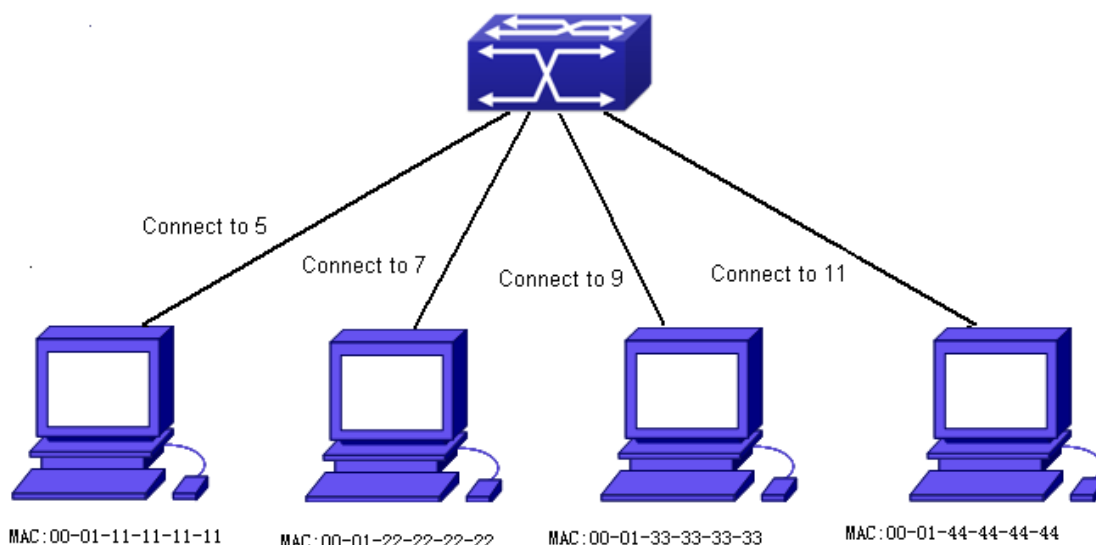

Fig 2-2 MAC Table typical configuration example

Scenario:

Four PCs as shown in the above figure connect to port 1/0/5, 1/0/7, 1/0/9, 1/0/11 of switch, all the four PCs belong to the default VLAN1. As required by the network environment, dynamic learning is enabled. PC1 holds sensitive data and can not be accessed by any other PC that is in another physical segment; PC2 and PC3 have static mapping set to port 1/0/7 and port 1/0/9, respectively.

The configuration steps are listed below:

1. Set the MAC address 00-01-11-11-11-11 of PC1 as a filter address.

```
Switch(config)#mac-address-table static 00-01-11-11-11-11 discard vlan 1.
```

2. Set the static mapping relationship for PC2 and PC3 to port 1/0/7 and port 1/0/9, respectively.

```
Switch(config)#mac-address-table static address 00-01-22-22-22-22 vlan 1 interface ethernet 1/0/7
```

```
Switch(config)#mac-address-table static address 00-01-33-33-33-33 vlan 1 interface ethernet 1/0/9
```

2.4 MAC Table Troubleshooting

Using the show mac-address-table command, a port is found to be failed to learn the MAC of a device connected to it. Possible reasons:

- ☞ The connected cable is broken.
- ☞ Spanning Tree is enabled and the port is in “discarding” status; or the device is just connected to the port and Spanning Tree is still under calculation, wait until the Spanning Tree calculation finishes, and the port will learn the MAC address.
- ☞ If not the problems mentioned above, please check for the switch port and contact technical support for solution.

2.5 MAC Notification Configuration

2.5.1 Introduction to MAC Notification

MAC Notification function depends on the notification. Add or remove the MAC address, namely, when the device is added or removed, it will notify administrator about the changing by the trap function of snmp.

2.5.2 MAC Notification Configuration

Mac notification configuration task list:

1. Configure the global snmp MAC notification
2. Configure the global MAC notification
3. Configure the interval for sending MAC notification
4. Configure the size of history table
5. Configure the trap type of MAC notification supported by the port
6. Show the configuration and the data of MAC notification
7. Clear the statistics of MAC notification trap

1. Configure the global snmp MAC notification

Command	Explanation
Global mode	
snmp-server enable traps mac-notification no snmp-server enable traps mac-notification	Configure or cancel the global snmp MAC notification.

2. Configure the global MAC notification

Command	Explanation
Global mode	
mac-address-table notification no mac-address-table notification	Configure or cancel the global MAC notification.

3. Configure the interval for sending MAC notification

Command	Explanation
Global mode	
mac-address-table notification interval <0-86400> no mac-address-table notification interval	Configure the interval for sending the MAC address notification, the no command restores the default interval.

4. Configure the size of history table

Command	Explanation
Global mode	
mac-address-table notification history-size <0-500> no mac-address-table notification history-size	Configure the history table size, the no command restores the default value.

5. Configure the trap type of MAC notification supported by the port

Command	Explanation
Port mode	
mac-notification {added both removed} no mac-notification	Configure or cancel the trap type of MAC notification supported by the port.

6. Show the configuration and the data of MAC notification

Command	Explanation
Admin mode	
show mac-notification summary	Show the configuration and the data of MAC notification.

7. Clear the statistics of MAC notification trap

Command	Explanation
Admin mode	
clear mac-notification statistics	Clear the statistics of MAC notification trap.

2.5.3 MAC Notification Example

IP address of network management station (NMS) is 1.1.1.5, IP address of Agent is 1.1.1.9. NMS will receive Trap message from Agent. (Note: NMS may set the authentication to the community character string of trap, suppose the community character string as usertrap)

Configuration procedure in the following:

```
Switch(config)#snmp-server enable
```

```
Switch(config)#snmp-server enable traps mac-notification
```

```
Switch(config)# mac-address-table notification
```

```
Switch(config)# mac-address-table notification interval 5
```

```
Switch(config)# mac-address-table notification history-size 100
```

```
Switch(Config-If-Ethernet1/0/4)# mac-notification both
```

2.5.4 MAC Notification Troubleshooting

Check whether trap message is sent successfully by show command and debug command of snmp.