

## Content

<b>CHAPTER 1 PORT CONFIGURATION</b> .....	<b>1-1</b>
1.1 INTRODUCTION TO PORT .....	1-1
1.2 NETWORK PORT CONFIGURATION TASK LIST .....	1-1
1.3 PORT CONFIGURATION EXAMPLE .....	1-4
1.4 PORT TROUBLESHOOTING .....	1-5
<b>CHAPTER 2 PORT ISOLATION FUNCTION CONFIGURATION</b> .....	<b>2-1</b>
2.1 INTRODUCTION TO PORT ISOLATION FUNCTION .....	2-1
2.2 TASK SEQUENCE OF PORT ISOLATION.....	2-1
2.3 PORT ISOLATION FUNCTION TYPICAL EXAMPLES .....	2-2
<b>CHAPTER 3 PORT LOOPBACK DETECTION FUNCTION</b> <b>CONFIGURATION</b> .....	<b>3-1</b>
3.1 INTRODUCTION TO PORT LOOPBACK DETECTION FUNCTION .....	3-1
3.2 PORT LOOPBACK DETECTION FUNCTION CONFIGURATION TASK LIST .....	3-2
3.3 PORT LOOPBACK DETECTION FUNCTION EXAMPLE .....	3-3
3.4 PORT LOOPBACK DETECTION TROUBLESHOOTING .....	3-4
<b>CHAPTER 4 ULDP FUNCTION CONFIGURATION</b> .....	<b>4-1</b>
4.1 INTRODUCTION TO ULDP FUNCTION .....	4-1
4.2 ULDP CONFIGURATION TASK SEQUENCE .....	4-2
4.3 ULDP FUNCTION TYPICAL EXAMPLES .....	4-5
4.4 ULDP TROUBLESHOOTING .....	4-6
<b>CHAPTER 5 LLDP FUNCTION OPERATION CONFIGURATION</b>	

---

.....	5-1
5.1 INTRODUCTION TO LLDP FUNCTION .....	5-1
5.2 LLDP FUNCTION CONFIGURATION TASK SEQUENCE.....	5-2
5.3 LLDP FUNCTION TYPICAL EXAMPLE .....	5-5
5.4 LLDP FUNCTION TROUBLESHOOTING.....	5-6
<b>CHAPTER 6 PORT CHANNEL CONFIGURATION .....</b>	<b>6-1</b>
6.1 INTRODUCTION TO PORT CHANNEL.....	6-1
6.2 BRIEF INTRODUCTION TO LACP .....	6-2
6.2.1 Static LACP Aggregation.....	6-3
6.2.2 Dynamic LACP Aggregation .....	6-3
6.3 PORT CHANNEL CONFIGURATION TASK LIST .....	6-4
6.4 PORT CHANNEL EXAMPLES .....	6-5
6.5 PORT CHANNEL TROUBLESHOOTING .....	6-8
<b>CHAPTER 7 MTU CONFIGURATION .....</b>	<b>7-1</b>
7.1 INTRODUCTION TO MTU.....	7-1
7.2 MTU CONFIGURATION TASK SEQUENCE .....	7-1
<b>CHAPTER 8 EFM OAM CONFIGURATION.....</b>	<b>8-1</b>
8.1 INTRODUCTION TO EFM OAM.....	8-1
8.2 EFM OAM CONFIGURATION .....	8-4
8.3 EFM OAM EXAMPLE .....	8-6
8.4 EFM OAM TROUBLESHOOTING .....	8-7
<b>CHAPTER 9 PORT SECURITY .....</b>	<b>9-1</b>
9.1 INTRODUCTION TO PORT SECURITY.....	9-1
9.2 PORT SECURITY CONFIGURATION TASK LIST .....	9-1
9.3 EXAMPLE OF PORT SECURITY .....	9-2
9.4 PORT SECURITY TROUBLESHOOTING .....	9-3

---

<b>CHAPTER 10 DDM CONFIGURATION.....</b>	<b>10-1</b>
<b>10.1 INTRODUCTION TO DDM .....</b>	<b>10-1</b>
10.1.1 Brief Introduction to DDM .....	10-1
10.1.2 DDM Function.....	10-2
<b>10.2 DDM CONFIGURATION TASK LIST.....</b>	<b>10-3</b>
<b>10.3 EXAMPLES OF DDM .....</b>	<b>10-5</b>
<b>10.4 DDM TROUBLESHOOTING.....</b>	<b>10-10</b>
<b>CHAPTER 11 LLDP-MED .....</b>	<b>11-1</b>
11.1 INTRODUCTION TO LLDP-MED .....	11-1
11.2 LLDP-MED CONFIGURATION TASK SEQUENCE.....	11-1
11.3 LLDP-MED EXAMPLE.....	11-4
11.4 LLDP-MED TROUBLESHOOTING.....	11-7
<b>CHAPTER 12 BPDU-TUNNEL-PROTOCOL CONFIGURATION</b>	
<b>.....</b>	<b>12-1</b>
12.1 INTRODUCTION TO BPDU-TUNNEL-PROTOCOL.....	12-1
12.1.1 bpdu-tunnel-protocol function .....	12-1
12.1.2 Background of bpdu-tunnel-protocol .....	12-1
12.2 BPDU-TUNNEL-PROTOCOL CONFIGURATION TASK LIST .....	12-2
12.3 EXAMPLES OF BPDU-TUNNEL-PROTOCOL .....	12-3
12.4 BPDU-TUNNEL-PROTOCOL TROUBLESHOOTING .....	12-5
<b>CHAPTER 13 EEE ENERGY-SAVING CONFIGURATION .....</b>	<b>13-1</b>
13.1 INTRODUCTION TO EEE ENERGY-SAVING .....	13-1
13.2 EEE ENERGY-SAVING CONFIGURATION LIST .....	13-1
13.3 EEE ENERGY-SAVING TYPICAL EXAMPLES.....	13-1
<b>CHAPTER 14 LED SHUT-OFF CONFIGURATION .....</b>	<b>14-1</b>
14.1 INTRODUCTION TO LED SHUT-OFF .....	14-1

14.2 LED SHUT-OFF CONFIGURATION .....14-1

14.3 LED SHUT-OFF EXAMPLES.....14-1

# Chapter 1 Port Configuration

## 1.1 Introduction to Port

Switch contain Cable ports and Combo ports. The Combo ports can be configured to as either 1000GX-TX ports or SFP Gigabit fiber ports.

If the user needs to configure some network ports, he/she can use the interface ethernet <interface-list> command to enter the appropriate Ethernet port configuration mode, where <interface-list> stands for one or more ports. If <interface-list> contains multiple ports, special characters such as ';' or '-' can be used to separate ports, ';' is used for discrete port numbers and '-' is used for consecutive port numbers. Suppose an operation should be performed on ports 2,3,4,5 the command would look like: interface ethernet 1/0/2-5. Port speed, duplex mode and traffic control can be configured under Ethernet Port Mode causing the performance of the corresponding network ports to change accordingly.

## 1.2 Network Port Configuration Task List

1. Enter the network port configuration mode
2. Configure the properties for the network ports
  - (1) Configure combo mode for combo ports
  - (2) Enable/Disable ports
  - (3) Configure port names
  - (4) Configure port cable types
  - (5) Configure port speed and duplex mode
  - (6) Configure bandwidth control
  - (7) Configure traffic control
  - (8) Enable/Disable port loopback function
  - (9) Configure broadcast storm control function for the switch
  - (10) Configure scan port mode
  - (11) Configure rate-violation control of the port
  - (12) Configure interval of port-rate-statistics
3. Virtual cable test

**1. Enter the Ethernet port configuration mode**

Command	Explanation
Global Mode	
<b>interface ethernet &lt;interface-list&gt;</b>	Enters the network port configuration mode.

**2. Configure the properties for the Ethernet ports**

Command	Explanation
Port Mode	
<b>media-type {copper   copper-preferred-auto   fiber   sfp-preferred-auto}</b>	Sets the combo port mode (combo ports only).
<b>shutdown</b> <b>no shutdown</b>	Enables/Disables specified ports.
<b>description &lt;string&gt;</b> <b>no description</b>	Specifies or cancels the name of specified ports.
<b>speed-duplex {auto [10 [100 [1000]] [auto   full   half ]]   force10-half   force10-full   force100-half   force100-full   force100-fx [module-type {auto-detected   no-phy-integrated   phy-integrated}]   {{force1g-half   force1g-full} [nonegotiate [master   slave]]} force10g-full}</b> <b>no speed-duplex</b>	Sets port speed and duplex mode of 100/1000Base-TX or 100Base-FX ports. The no format of this command restores the default setting, i.e., negotiates speed and duplex mode automatically.
<b>negotiation {on off}</b>	Enables/Disables the auto-negotiation function of 1000Base-FX ports.
<b>bandwidth control &lt;bandwidth&gt;</b> <b>[both   receive   transmit]</b> <b>no bandwidth control</b>	Sets or cancels the bandwidth used for incoming/outgoing traffic for specified ports.
<b>flow control</b> <b>no flow control</b>	Enables/Disables traffic control function for specified ports.
<b>loopback</b> <b>no loopback</b>	Enables/Disables loopback test function for specified ports.

<pre>storm control {unicast   broadcast   multicast} &lt;1-1488095&gt; no storm control {unicast   broadcast   multicast}&gt;</pre>	<p>Enables the storm control function for broadcasts, multicasts and unicasts with unknown destinations (short for broadcast), and sets the allowed broadcast packet number or the bit number passing per second; the no format of this command disables the broadcast storm control function.</p>
<pre>switchport flood-control { bcast mcast ucast } no switchport flood-control { bcast mcast ucast }</pre>	<p>Configure that switch does not transmit broadcast, unknown multicast or unknown unicast packets any more to the specified port; no command restores the default configuration. Note: This switch does not support this command.</p>
<pre>port-scan-mode {interrupt   poll} no port-scan-mode</pre>	<p>Configure the scan mode of the port as “interrupt” or “poll”, the no command restores the default scan mode.</p>
<pre>rate-violation &lt;200-2000000&gt; [recovery &lt;0-86400&gt;] no rate-violation</pre>	<p>Set the max packet reception rate of a port. If the rate of the received packet violates the packet reception rate, shut down this port and configures the recovery time, the default is 300s. The no command will disable the rate-violation function of a port.</p>
Global Mode	
<pre>port-rate-statistics interval &lt;interval -value&gt;</pre>	<p>Configure the interval of port-rate-statistics.</p>
<pre>storm control kbps   pps</pre>	<p>Configure units kbps or pps for storm control function</p>

### 3. Virtual cable test

Command	Explanation
Admin Mode	
<pre>virtual-cable-test interface (ethernet )IIFNAME</pre>	<p>Test virtual cables of the port.</p>

## 1.3 Port Configuration Example

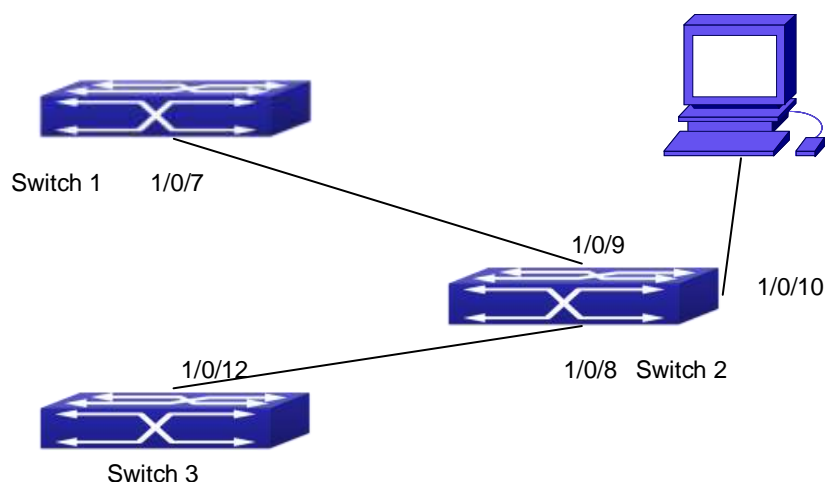

Fig 1-1 Port Configuration Example

No VLAN has been configured in the switches, default VLAN1 is used.

Switch	Port	Property
Switch1	1/0/7	Ingress bandwidth limit: 50 M
Switch2	1/0/8	Mirror source port
	1/0/9	100Mbps full, mirror source port
	1/0/10	1000Mbps full, mirror destination port
Switch3	1/0/12	100Mbps full

The configurations are listed below:

### Switch1:

```
Switch1(config)#interface ethernet 1/0/7
Switch1(Config-If-Ethernet1/0/7)# bandwidth control 50000 receive
```

### Switch2:

```
Switch2(config)#interface ethernet 1/0/9
Switch2(Config-If-Ethernet1/0/9)#speed-duplex force100-full
Switch2(Config-If-Ethernet1/0/9)#exit
Switch2(config)#interface ethernet 1/0/10
Switch2(Config-If-Ethernet1/0/10)#speed-duplex force1g-full
Switch2(Config-If-Ethernet1/0/10)#exit
Switch2(config)#monitor session 1 source interface ethernet 1/0/8;1/0/9
Switch2(config)#monitor session 1 destination interface ethernet 1/0/10
```

### Switch3:

```
Switch3(config)#interface ethernet 1/0/12
Switch3(Config-If-Ethernet1/0/12)#speed-duplex force100-full
Switch3(Config-If-Ethernet1/0/12)#exit
```



## 1.4 Port Troubleshooting

Here are some situations that frequently occurs in port configuration and the advised solutions:

- ☞ Two connected fiber interfaces won't link up if one interface is set to auto-negotiation but the other to forced speed/duplex. This is determined by IEEE 802.3.
- ☞ The following combinations are not recommended: enabling traffic control as well as setting multicast limiting for the same port; setting broadcast, multicast and unknown destination unicast control as well as port bandwidth limiting for the same port. If such combinations are set, the port throughput may fall below the expected performance.

# Chapter 2 Port Isolation Function Configuration

## 2.1 Introduction to Port Isolation Function

Port isolation is an independent port-based function working in an inter-port way, which isolates flows of different ports from each other. With the help of port isolation, users can isolate ports within a VLAN to save VLAN resources and enhance network security. After this function is configured, the ports in a port isolation group will be isolated from each other, while ports belonging to different isolation groups or no such group can forward data to one another normally. No more than 16 port isolation groups can a switch have.

This switch also supports the port isolation that based on vlan, namely it can realize port isolation in one vlan.

## 2.2 Task Sequence of Port Isolation

1. Create an isolate port group
2. Add Ethernet ports into the group
3. Display the configuration of port isolation

### 1. Create an isolate port group

Command	Explanation
Global Mode	
<b>isolate-port group &lt;WORD&gt;</b> <b>no isolate-port group &lt;WORD&gt;</b>	Set a port isolation group; the no operation of this command will delete the port isolation group.

### 2. Add Ethernet ports into the group

Command	Explanation
Global Mode	
<b>isolate-port group &lt;WORD&gt; switchport interface [ethernet] &lt;IFNAME&gt;</b> <b>no isolate-port group &lt;WORD&gt; switchport interface [ethernet]</b>	Add one port or a group of ports into a port isolation group to isolate, which will become isolated from the other ports in the group; the no operation of this command will

<IFNAME>	remove one port or a group of ports out of a port isolation group.
----------	--

### 3. Display the configuration of port isolation

Command	Explanation
Admin Mode and Global Mode	
<b>show isolate-port group [ &lt;WORD&gt; ]</b>	Display the configuration of port isolation, including all configured port isolation groups and Ethernet ports in each group.

## 2.3 Port Isolation Function Typical Examples

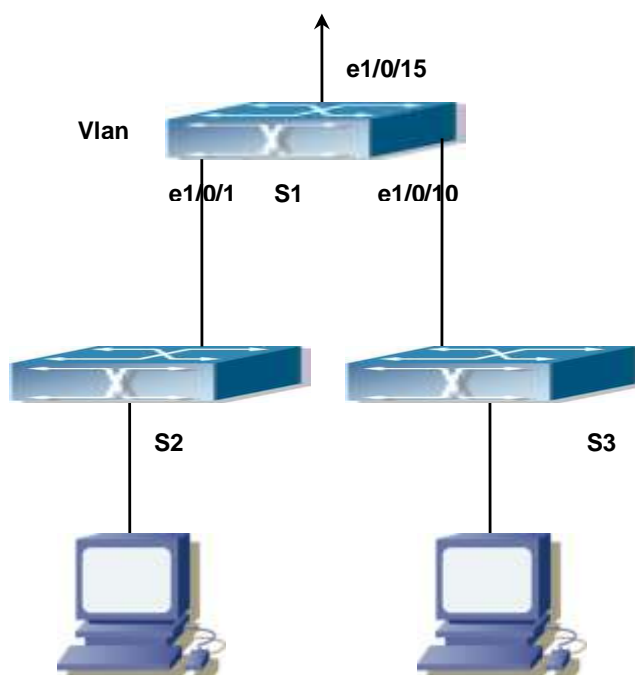

Fig 2-1 Typical example of port isolation function

Case 1 : Realize port isolation in the vlan it belongs to.

The topology and configuration of switches are showed in the figure above, with e1/0/1, e1/0/10 and e1/0/15 all belonging to VLAN 100. The requirement is that, after port isolation is enabled on switch S1, e1/0/1 and e1/0/10 on switch S1 can not communicate with each other, while both of them can communicate with the uplink port e1/0/15. That is, the communication between any pair of downlink ports is disabled (vlan100-120) while that between any downlink port and a specified uplink port is normal. The uplink port can communicate with any port normally.

The configuration of S1:

```
Switch(config)#interference ethernet 1/0/1;10;15
```

```
Switch(config-if-port-range)#switchport mode trunk
```

```
Switch(config)#isolate-port group test
```

```
Switch(config)#isolate-port group test switchport interface ethernet 1/0/1;1/0/10
```

Case 2: Realize port isolation in a vlan

The topology and configuration of switches are showed in the figure above, with e1/0/1, e1/0/10 and e1/0/15 all belonging to VLAN 100-120. The requirement is that, after port isolation is enabled on switch S1, e1/0/1 and e1/0/10 on switch S1 can not communicate with each other in vlan100 but communicate with each other in vlan101-120, while both of them can communicate with the uplink port e1/0/15 in vlan100-120.

The configuration of S1:

```
Switch(config)#interference ethernet 1/0/1;10;15
```

```
Switch(config-if-port-range)#switchport mode trunk
```

```
Switch(config)#vlan 100
```

```
Switch(config-vlan 100)#isolate-port group test switchport interface ethernet 1/0/1;1/0/10
```

# Chapter 3 Port Loopback Detection Function Configuration

## 3.1 Introduction to Port Loopback Detection Function

With the development of switches, more and more users begin to access the network through Ethernet switches. In enterprise network, users access the network through layer-2 switches, which means urgent demands for both internet and the internal layer 2 Interworking. When layer 2 Interworking is required, the messages will be forwarded through MAC addressing the accuracy of which is the key to a correct Interworking between users. In layer 2 switching, the messages are forwarded through MAC addressing. Layer 2 devices learn MAC addresses via learning source MAC address, that is, when the port receives a message from an unknown source MAC address, it will add this MAC to the receive port, so that the following messages with a destination of this MAC can be forwarded directly, which also means learn the MAC address once and for all to forward messages.

When a new source MAC is already learnt by the layer 2 device, only with a different source port, the original source port will be modified to the new one, which means to correspond the original MAC address with the new port. As a result, if there is any loopback existing in the link, all MAC addresses within the whole layer 2 network will be corresponded with the port where the loopback appears (usually the MAC address will be frequently shifted from one port to another ), causing the layer 2 network collapsed. That is why it is a necessity to check port loopbacks in the network. When a loopback is detected, the detecting device should send alarms to the network management system, ensuring the network manager is able to discover, locate and solve the problem in the network and protect users from a long-lasting disconnected network.

Since detecting loopbacks can make dynamic judgment of the existence of loopbacks in the link and tell whether it has gone, the devices supporting port control (such as port isolation and port MAC address learning control) can maintain that automatically, which will not only reduce the burden of network managers but also response time, minimizing the effect caused loopbacks to the network.

## 3.2 Port Loopback Detection Function Configuration

### Task List

1. Configure the time interval of loopback detection
2. Enable the function of port loopback detection
3. Configure the control method of port loopback detection
4. Display and debug the relevant information of port loopback detection
5. Configure the loopback-detection control mode (automatic recovery enabled or not)

#### 1. Configure the time interval of loopback detection

Command	Explanation
Global Mode	
<b>loopback-detection interval-time</b> <b>&lt;loopback&gt; &lt;no-loopback&gt;</b> <b>no loopback-detection interval-time</b>	Configure the time interval of loopback detection.

#### 2. Enable the function of port loopback detection

Command	Explanation
Port Mode	
<b>loopback-detection specified-vlan</b> <b>&lt;vlan-list&gt;</b> <b>no loopback-detection specified-vlan</b> <b>&lt;vlan-list&gt;</b>	Enable and disable the function of port loopback detection.

#### 3. Configure the control method of port loopback detection

Command	Explanation
Port Mode	
<b>loopback-detection control {shutdown</b> <b> block }</b> <b>no loopback-detection control</b>	Enable and disable the function of port loopback detection control.

#### 4. Display and debug the relevant information of port loopback detection

Command	Explanation
Admin Mode	
<b>debug loopback-detection</b> <b>no debug loopback-detection</b>	Enable the debug information of the function module of port loopback detection. The no operation of this command will disable the debug information.
<b>show loopback-detection [interface &lt;interface-list&gt;]</b>	Display the state and result of the loopback detection of all ports, if no parameter is provided; otherwise, display the state and result of the corresponding ports.

#### 5. Configure the loopback-detection control mode (automatic recovery enabled or not)

Command	Explanation
Global Mode	
<b>loopback-detection control-recovery timeout &lt;0-3600&gt;</b>	Configure the loopback-detection control mode (automatic recovery enabled or not) or recovery time.

### 3.3 Port Loopback Detection Function Example



Fig 3-1 Typical example of port loopback detection

As shown in the above configuration, the switch will detect the existence of loopbacks in the network topology. After enabling the function of loopback detection on the port connecting the switch with the outside network, the switch will notify the connected network about the existence of a loopback, and control the port on the switch to guarantee the normal operation of the whole network.

The configuration task sequence of SWITCH:

```
Switch(config)#loopback-detection interval-time 35 15
```

```
Switch(config)#interface ethernet 1/0/1
```

```
Switch(Config-If-Ethernet1/0/1)#loopback-detection special-vlan 1-3
```

```
Switch(Config-If-Ethernet1/0/1)#loopback-detection control block
```

If adopting the control method of block, MSTP should be globally enabled. And the corresponding relation between the spanning tree instance and the VLAN should be configured.

```
Switch(config)#spanning-tree
```

```
Switch(config)#spanning-tree mst configuration
```

```
Switch(Config-Mstp-Region)#instance 1 vlan 1
```

```
Switch(Config-Mstp-Region)#instance 2 vlan 2
```

```
Switch(Config-Mstp-Region)#
```

### **3.4 Port Loopback Detection Troubleshooting**

The function of port loopback detection is disabled by default and should only be enabled if required.



# Chapter 4 ULDP Function Configuration

## 4.1 Introduction to ULDP Function

Unidirectional link is a common error state of link in networks, especially in fiber links. Unidirectional link means that only one port of the link can receive messages from the other port, while the latter one can not receive messages from the former one. Since the physical layer of the link is connected and works normal, via the checking mechanism of the physical layer, communication problems between the devices can not be found. As shown in Graph, the problem in fiber connection can not be found through mechanisms in physical layer like automatic negotiation.

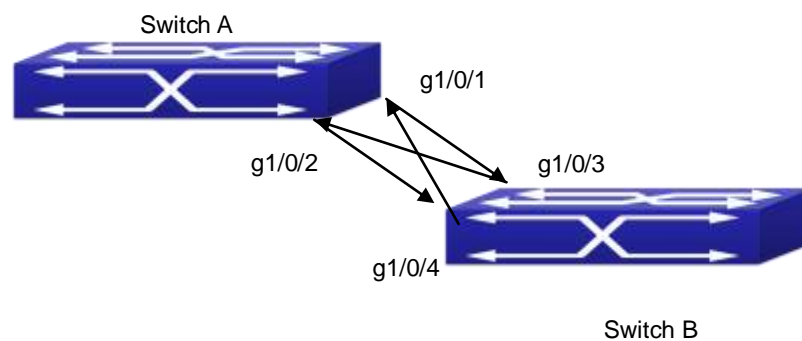

Fig 4-1 Fiber Cross Connection

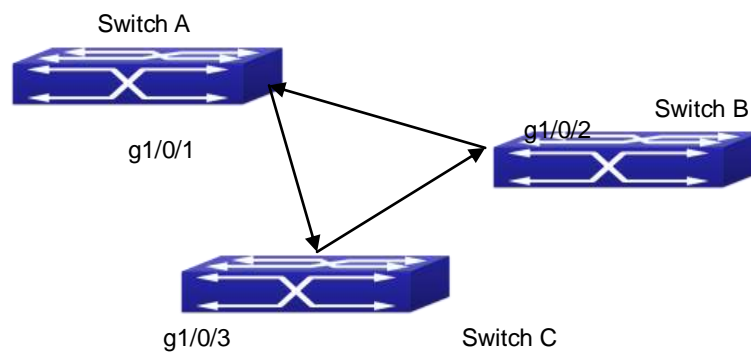

Fig 4-2 One End of Each Fiber Not Connected

This kind of problem often appears in the following situations: GBIC (Giga Bitrate Interface Converter) or interfaces have problems, software problems; hardware becomes unavailable or operates abnormally. Unidirectional link will cause a series of problems, such as spinning tree topological loop, broadcast black hole.

ULDP (Unidirectional Link Detection Protocol) can help avoid disasters that could happen in the situations mentioned above. In a switch connected via fibers or copper Ethernet line (like ultra five-kind twisted pair), ULDP can monitor the link state of physical links. Whenever a unidirectional link is discovered, it will send warnings to users and can disable the port automatically or manually according to users' configuration.

The ULDP of switches recognizes remote devices and check the correctness of link connections via interacting ULDP messages. When ULDP is enabled on a port, protocol state machine will be started, which means different types of messages will be sent at different states of the state machine to check the connection state of the link by exchanging information with remote devices. ULDP can dynamically study the interval at which the remote device sends notification messages and adjust the local TTL (time to live) according to that interval. Besides, ULDP provides the reset mechanism, when the port is disabled by ULDP, it can check again through reset mechanism. The time intervals of notification messages and reset in ULDP can be configured by users, so that ULDP can respond faster to connection errors in different network environments.

The premise of ULDP working normally is that link works in duplex mode, which means ULDP is enabled on both ends of the link, using the same method of authentication and password.

## 4.2 ULDP Configuration Task Sequence

1. Enable ULDP function globally
2. Enable ULDP function on a port
3. Configure aggressive mode globally
4. Configure aggressive mode on a port
5. Configure the method to shut down unidirectional link
6. Configure the interval of Hello messages
7. Configure the interval of Recovery
8. Reset the port shut down by ULDP
9. Display and debug the relative information of ULDP

### 1. Enable ULDP function globally

Command	Explanation
Global configuration mode	

<b>uldp enable</b>	Globally enable or disable ULDP function.
<b>uldp disable</b>	

## 2. Enable ULDP function on a port

Command	Explanation
Port configuration mode	
<b>uldp enable</b>	Enable or disable ULDP function on a port.
<b>uldp disable</b>	

## 3. Configure aggressive mode globally

Command	Explanation
Global configuration mode	
<b>uldp aggressive-mode</b>	Set the global working mode.
<b>no uldap aggressive-mode</b>	

## 4. Configure aggressive mode on a port

Command	Explanation
Port configuration mode	
<b>uldp aggressive-mode</b>	Set the working mode of the port.
<b>no uldap aggressive-mode</b>	

## 5. Configure the method to shut down unidirectional link

Command	Explanation
Global configuration mode	
<b>uldp manual-shutdown</b>	Configure the method to shut down unidirectional link.
<b>no uldap manual-shutdown</b>	

## 6. Configure the interval of Hello messages

Command	Explanation
Global configuration mode	
<b>uldp hello-interval &lt;integer&gt;</b>	Configure the interval of Hello messages, ranging from 5 to 100 seconds. The value is 10 seconds by default.
<b>no uldap hello-interval</b>	

## 7. Configure the interval of Recovery

Command	Explanation
Global configuration mode	

<b>uldp recovery-time &lt;integer&gt;</b> <b>no uldap recovery-time &lt;integer&gt;</b>	Configure the interval of Recovery reset, ranging from 30 to 86400 seconds. The value is 0 second by default.
--	---

### 8. Reset the port shut down by ULDP

Command	Explanation
Global configuration mode or port configuration mode	
<b>uldp reset</b>	Reset all ports in global configuration mode; Reset the specified port in port configuration mode.

### 9. Display and debug the relative information of ULDP

Command	Explanation
Admin mode	
<b>show uldap [interface ethernet IFNAME]</b>	Display ULDP information. No parameter means to display global ULDP information. The parameter specifying a port will display global information and the neighbor information of the port.
<b>debug uldap fsm interface ethernet &lt;IFname&gt;</b> <b>no debug uldap fsm interface ethernet &lt;IFname&gt;</b>	Enable or disable the debug switch of the state machine transition information on the specified port.
<b>debug uldap error</b> <b>no debug uldap error</b>	Enable or disable the debug switch of error information.
<b>debug uldap event</b> <b>no debug uldap event</b>	Enable or disable the debug switch of event information.
<b>debug uldap packet {receive send}</b> <b>no debug uldap packet {receive send}</b>	Enable or disable the type of messages can be received and sent on all ports.
<b>debug uldap {hello probe echo unidir all} [receive send] interface ethernet &lt;IFname&gt;</b> <b>no debug uldap {hello probe echo unidir all} [receive send] interface ethernet &lt;IFname&gt;</b>	Enable or disable the content detail of a particular type of messages can be received and sent on the specified port.

## 4.3 ULDP Function Typical Examples

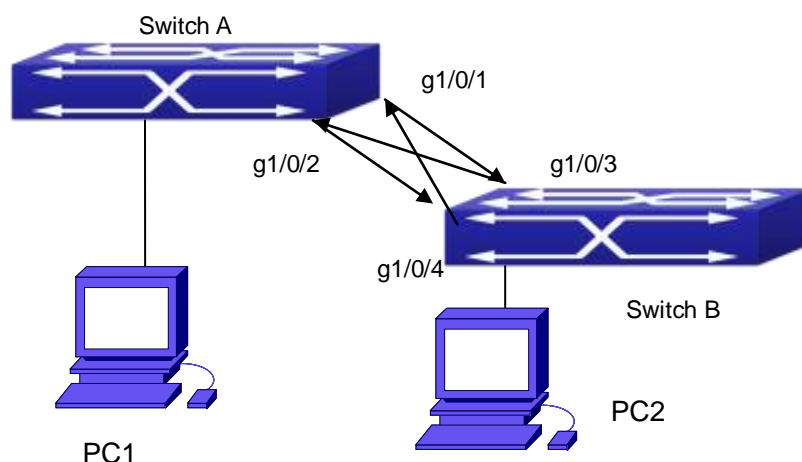

Fig 4-3 Fiber Cross Connection

In the network topology in Graph, port g1/0/1 and port g1/0/2 of SWITCH A as well as port g1/0/3 and port g1/0/4 of SWITCH B are all fiber ports. And the connection is cross connection. The physical layer is connected and works normally, but the data link layer is abnormal. ULDP can discover and disable this kind of error state of link. The final result is that port g1/0/1, g1/0/2 of SWITCH A and port g1/0/3, g1/0/4 of SWITCH B are all shut down by ULDP. Only when the connection is correct, can the ports work normally (won't be shut down).

Switch A configuration sequence:

```
SwitchA(config)#uldp enable
```

```
SwitchA(config)#interface ethernet 1/0/1
```

```
SwitchA(Config-If-Ethernet1/0/1)#uldp enable
```

```
SwitchA(Config-If-Ethernet1/0/1)#exit
```

```
SwitchA(config)#interface ethernet 1/0/2
```

```
SwitchA(Config-If-Ethernet1/0/2)#uldp enable
```

Switch B configuration sequence:

```
SwitchB(config)#uldp enable
```

```
SwitchB(config)#interface ethernet1/0/3
```

```
SwitchB(Config-If-Ethernet1/0/3)#uldp enable
```

```
SwitchB(Config-If-Ethernet1/0/3)#exit
```

```
SwitchB(config)#interface ethernet 1/0/4
```

```
SwitchB(Config-If-Ethernet1/0/4)#uldp enable
```

As a result, port g1/0/1, g1/0/2 of SWITCH A are all shut down by ULDP, and there is

notification information on the CRT terminal of PC1.

```
%Oct 29 11:09:50 2007 A unidirectional link is detected! Port Ethernet1/0/1 need to be shutted down!
```

```
%Oct 29 11:09:50 2007 Unidirectional port Ethernet1/0/1 shut down!
```

```
%Oct 29 11:09:50 2007 A unidirectional link is detected! Port Ethernet1/0/2 need to be shutted down!
```

```
%Oct 29 11:09:50 2007 Unidirectional port Ethernet1/0/2 shutted down!
```

Port g1/0/3, and port g1/0/4 of SWITCH B are all shut down by ULDP, and there is notification information on the CRT terminal of PC2.

```
%Oct 29 11:09:50 2007 A unidirectional link is detected! Port Ethernet1/0/3 need to be shutted down!
```

```
%Oct 29 11:09:50 2007 Unidirectional port Ethernet1/0/3 shutted down!
```

```
%Oct 29 11:09:50 2007 A unidirectional link is detected! Port Ethernet1/0/4 need to be shutted down!
```

```
%Oct 29 11:09:50 2007 Unidirectional port Ethernet1/0/4 shutted down!
```

## 4.4 ULDP Troubleshooting

Configuration Notice:

- ☞ In order to ensure that ULDP can discover that the one of fiber ports has not connected or the ports are incorrectly cross connected, the ports have to work in duplex mode and have the same rate.
- ☞ If the automatic negotiation mechanism of the fiber ports with one port misconnected decides the working mode and rate of the ports, ULDP won't take effect no matter enabled or not. In such situation, the port is considered as "Down".
- ☞ In order to make sure that neighbors can be correctly created and unidirectional links can be correctly discovered, it is required that both end of the link should enable ULDP, using the same authentication method and password. At present, no password is needed on both ends.
- ☞ The hello interval of sending hello messages can be changed (it is 10 seconds by default and ranges from 5 to 100 seconds) so that ULDP can respond faster to connection errors of links in different network environments. But this interval should be less than 1/3 of the STP convergence time. If the interval is too long, a STP loop will be generated before ULDP discovers and shuts down the unidirectional connection port. If the interval is too short, the network burden on the port will be increased, which means a reduced bandwidth.
- ☞ ULDP does not handle any LACP event. It treats every link of TRUNK group (like Port-channel, TRUNK ports) as independent, and handles each of them respectively.

- ☞ ULDP does not compact with similar protocols of other vendors, which means users can not use ULDP on one end and use other similar protocols on the other end.
- ☞ ULDP function is disabled by default. After globally enabling ULDP function, the debug switch can be enabled simultaneously to check the debug information. There are several DEBUG commands provided to print debug information, such as information of events, state machine, errors and messages. Different types of message information can also be printed according to different parameters.
- ☞ The Recovery timer is disabled by default and will only be enabled when the users have configured recovery time (30-86400 seconds).
- ☞ Reset command and reset mechanism can only reset the ports automatically shut down by ULDP. The ports shut down manually by users or by other modules won't be reset by ULDP.

# Chapter 5 LLDP Function Operation Configuration

## 5.1 Introduction to LLDP Function

Link Layer Discovery Protocol (LLDP) is a new protocol defined in 802.1ab. It enables neighbor devices to send notices of their own state to other devices, and enables all ports of every device to store information about them. If necessary, the ports can also send update information to the neighbor devices directly connected to them, and those neighbor devices will store the information in standard SNMP MIBs. The network management system can check the layer-two connection state from MIB. LLDP won't configure or control network elements or flows, but only report the configuration of layer-two. Another content of 802.1ab is to utilizing the information provided by LLDP to find the conflicts in layer-two. IEEE now uses the existing physical topology, interfaces and Entity MIBs of IETF.

To simplify, LLDP is a neighbor discovery protocol. It defines a standard method for Ethernet devices, such as switches, routers and WLAN access points, to enable them to notify their existence to other nodes in the network and store the discovery information of all neighbor devices. For example, the detail information of the device configuration and discovery can both use this protocol to advertise.

In specific, LLDP defines a general advertisement information set, a transportation advertisement protocol and a method to store the received advertisement information. The device to advertise its own information can put multiple pieces of advertisement information in one LAN data packet to transport. The type of transportation is the type length value (TLV) field. All devices supporting LLDP have to support device ID and port ID advertisement, but it is assumed that, most devices should also support system name, system description and system performance advertisement. System name and system description advertisement can also provide useful information for collecting network flow data. System description advertisement can include data such as the full name of the advertising device, hardware type of system, the version information of software operation system and so on.

802.1AB Link Layer Discovery Protocol will make searching the problems in an enterprise network an easier process and can strengthen the ability of network management tools to discover and maintain accurate network topology structure.

Many kinds of network management software use "Automated Discovery" function to



trace the change and condition of topology, but most of them can reach layer-three and classify the devices into all IP subnets at best. This kind of data are very primitive, only referring to basic events like the adding and removing of relative devices instead of details about where and how these devices operate with the network.

Layer 2 discovery covers information like which devices have which ports, which switches connect to other devices and so on, it can also display the routs between clients, switches, routers, application servers and network servers. Such details will be very meaningful for schedule and investigate the source of network failure.

LLDP will be a very useful management tool, providing accurate information about network mirroring, flow data and searching network problems.

## 5.2 LLDP Function Configuration Task Sequence

1. Globally enable LLDP function
2. Configure the port-based LLDP function switch
3. Configure the operating state of port LLDP
4. Configure the intervals of LLDP updating messages
5. Configure the aging time multiplier of LLDP messages
6. Configure the sending delay of updating messages
7. Configure the intervals of sending Trap messages
8. Configure to enable the Trap function of the port
9. Configure the optional information-sending attribute of the port
10. Configure to enable the managed address tlv of lldp port
11. Configure the size of space to store Remote Table of the port
12. Configure the type of operation when the Remote Table of the port is full
13. Display and debug the relative information of LLDP

### 1. Globally enable LLDP function

Command	Explanation
Global Mode	
<b>lldp enable</b> <b>lldp disable</b>	Globally enable or disable LLDP function.

### 2. Configure the port-base LLDP function switch

Command	Explanation
Port Mode	
<b>lldp enable</b> <b>lldp disable</b>	Configure the port-base LLDP function switch.

**3. Configure the operating state of port LLDP**

Command	Explanation
Port Mode	
<b>lldp mode (send receive both disable)</b>	Configure the operating state of port LLDP.

**4. Configure the intervals of LLDP updating messages**

Command	Explanation
Global Mode	
<b>lldp tx-interval &lt;integer&gt;</b> <b>no lldp tx-interval</b>	Configure the intervals of LLDP updating messages as the specified value or default value.

**5. Configure the aging time multiplier of LLDP messages**

Command	Explanation
Global Mode	
<b>lldp msgTxHold &lt;value&gt;</b> <b>no lldp msgTxHold</b>	Configure the aging time multiplier of LLDP messages as the specified value or default value.

**6. Configure the sending delay of updating messages**

Command	Explanation
Global Mode	
<b>lldp transmit delay &lt;seconds&gt;</b> <b>no lldp transmit delay</b>	Configure the sending delay of updating messages as the specified value or default value.

**7. Configure the intervals of sending Trap messages**

Command	Explanation
Global Mode	
<b>lldp notification interval &lt;seconds&gt;</b> <b>no lldp notification interval</b>	Configure the intervals of sending Trap messages as the specified value or default value.

**8. Configure to enable the Trap function of the port**

Command	Explanation
Port Configuration Mode	

<b>lldp trap &lt;enable/disable&gt;</b>	Enable or disable the Trap function of the port.
---	--

### 9. Configure the optional information-sending attribute of the port

Command	Explanation
Port Configuration Mode	
<b>lldp transmit optional tlv [portDesc] [sysName] [sysDesc] [sysCap]</b> <b>no lldp transmit optional tlv</b>	Configure the optional information-sending attribute of the port as the option value of default values.

### 10. Configure to enable the managed address tlv of lldp port

Command	Explanation
Port Configuration Mode	
<b>lldp management-address tlv [A.B.C.D]</b> <b>no lldp management-address tlv</b>	Configure to enable/disable the management address tlv of lldp port.

### 11. Configure the size of space to store Remote Table of the port

Command	Explanation
Port Configuration Mode	
<b>lldp neighbors max-num &lt; value &gt;</b> <b>no lldp neighbors max-num</b>	Configure the size of space to store Remote Table of the port as the specified value or default value.

### 12. Configure the type of operation when the Remote Table of the port is full

Command	Explanation
Port Configuration Mode	
<b>lldp tooManyNeighbors {discard   delete}</b>	Configure the type of operation when the Remote Table of the port is full.

### 13. Display and debug the relative information of LLDP

Command	Explanation
Admin, Global Mode	
<b>show lldp</b>	Display the current LLDP configuration information.
<b>show lldp interface ethernet &lt;IFNAME&gt;</b>	Display the LLDP configuration information of the current port.

<b>show lldp traffic</b>	Display the information of all kinds of counters.
<b>show lldp neighbors interface ethernet &lt;IFNAME &gt;</b>	Display the information of LLDP neighbors of the current port.
<b>show debugging lldp</b>	Display all ports with LLDP debug enabled.
Admin Mode	
<b>debug lldp</b> <b>no debug lldp</b>	Enable or disable the DEBUG switch.
<b>debug lldp packets interface ethernet &lt;IFNAME &gt;</b> <b>no debug lldp packets interface ethernet &lt;IFNAME &gt;</b>	Enable or disable the DEBUG packet-receiving and sending function in port or global mode.
Port configuration mode	
<b>clear lldp remote-table</b>	Clear Remote-table of the port.

### 5.3 LLDP Function Typical Example

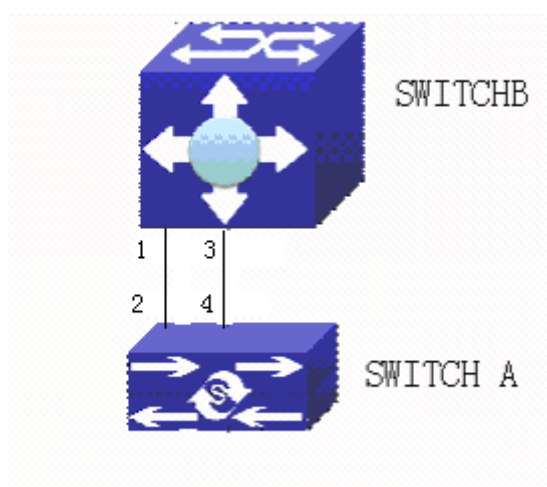

Fig 5-1 LLDP Function Typical Configuration Example

In the network topology graph above, the port 1,3 of SWITCH B are connected to port 2,4 of SWITCH A. Port 1 of SWITCH B is configured to message-receiving-only mode, Option TLV of port 4 of SWITCH A is configured as portDes and SysCap.

SWITCH A configuration task sequence:

```
SwitchA(config)# lldp enable
```

```
SwitchA(config)#interface ethernet 1/0/4
```

```
SwitchA(Config-If-Ethernet1/0/4)#lldp transmit optional tlv portDesc sysCap
```

```
SwitchA(Config-If-Ethernet1/0/4)#exit
```

SWITCH B configuration task sequence:

```
SwitchB(config)#lldp enable
```

```
SwitchB(config)#interface ethernet1/0/1
```

```
SwitchB(Config-If-Ethernet1/0/1)#lldp mode receive
```

```
SwitchB(Config-If-Ethernet1/0/1)#exit
```

## 5.4 LLDP Function Troubleshooting

- ☞ LLDP function is disabled by default. After enabling the global switch of LLDP, users can enable the debug switch “**debug lldp**” simultaneously to check debug information.
- ☞ Using “show” function of LLDP function can display the configuration information in global or port configuration mode.

# Chapter 6 Port Channel Configuration

## 6.1 Introduction to Port Channel

To understand Port Channel, Port Group should be introduced first. Port Group is a group of physical ports in the configuration level; only physical ports in the Port Group can take part in link aggregation and become a member port of a Port Channel. Logically, Port Group is not a port but a port sequence. Under certain conditions, physical ports in a Port Group perform port aggregation to form a Port Channel that has all the properties of a logical port, therefore it becomes an independent logical port. Port aggregation is a process of logical abstraction to abstract a set of ports (port sequence) with the same properties to a logical port. Port Channel is a collection of physical ports and used logically as one physical port. Port Channel can be used as a normal port by the user, and can not only add network's bandwidth, but also provide link backup. Port aggregation is usually used when the switch is connected to routers, PCs or other switches.

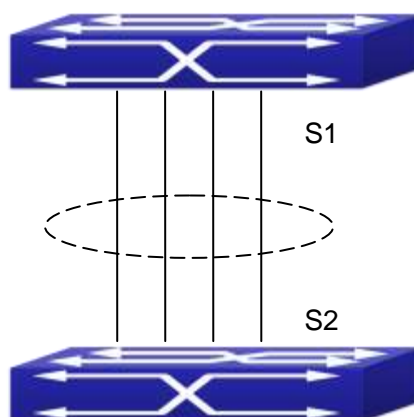

Fig 6-1 Port aggregation

As shown in the above, S1 is aggregated to a Port Channel, the bandwidth of this Port Channel is the total of all the four ports. If traffic from S1 needs to be transferred to S2 through the Port Channel, traffic allocation calculation will be performed based on the source MAC address and the lowest bit of target MAC address. The calculation result will decide which port to convey the traffic. If a port in Port Channel fails, the other ports will undertake traffic of that port through a traffic allocation algorithm. This algorithm is carried out by the hardware.

Switch offers two methods for configuring port aggregation: manual Port Channel creation and LACP (Link Aggregation Control Protocol) dynamic Port Channel creation.

Port aggregation can only be performed on ports in full-duplex mode.

For Port Channel to work properly, member ports of the Port Channel must have the same properties as follows:

- ☞ All ports are in full-duplex mode.
- ☞ All Ports are of the same speed.
- ☞ All ports are Access ports and belong to the same VLAN or are all TRUNK ports, or are all Hybrid ports.
- ☞ If the ports are all TRUNK ports or Hybrid ports, then their “Allowed VLAN” and “Native VLAN” property should also be the same.

If Port Channel is configured manually or dynamically on switch, the system will automatically set the port with the smallest number to be Master Port of the Port Channel. If the spanning tree function is enabled in the switch, the spanning tree protocol will regard Port Channel as a logical port and send BPDU frames via the master port.

Port aggregation is closely related with switch hardware. Switch allow physical port aggregation of any two switches, maximum 14 groups and 8 ports in each port group are supported.

Once ports are aggregated, they can be used as a normal port. Switch have a built-in aggregation interface configuration mode, the user can perform related configuration in this mode just like in the VLAN and physical interface configuration mode.

## 6.2 Brief Introduction to LACP

LACP (Link Aggregation Control Protocol) is a kind of protocol based on IEEE802.3ad standard to implement the link dynamic aggregation. LACP protocol uses LACPDU (Link Aggregation Control Protocol Data Unit) to exchange the information with the other end.

After LACP protocol of the port is enabled, this port will send LACPDU to the other end to notify the system priority, the MAC address of the system, the priority of the port, the port ID and the operation Key. After the other end receives the information, the information is compared with the saving information of other ports to select the port which can be aggregated, accordingly, both sides can reach an agreement about the ports join or exit the dynamic aggregation group.

The operation Key is created by LACP protocol according to the combination of configuration (speed, duplex, basic configuration, management Key) of the ports to be aggregated.

After the dynamic aggregation port enables LACP protocol, the management Key is 0 by default. After the static aggregation port enables LACP, the management Key of the port is the same with the ID of the aggregation group.

For the dynamic aggregation group, the members of the same group have the same operation Key, for the static aggregation group, the ports of Active have the same operation Key.

The port aggregation is that multi-ports are aggregated to form an aggregation group, so as to implement the out/in load balance in each member port of the aggregation group and provides the better reliability.

## 6.2.1 Static LACP Aggregation

Static LACP aggregation is enforced by users configuration, and do not enable LACP protocol. When configuring static LACP aggregation, use “on” mode to force the port to enter the aggregation group.

## 6.2.2 Dynamic LACP Aggregation

### 1. The summary of the dynamic LACP aggregation

Dynamic LACP aggregation is an aggregation created/deleted by the system automatically, it does not allow the user to add or delete the member ports of the dynamic LACP aggregation. The ports which have the same attribute of speed and duplex, are connected to the same device, have the same basic configuration, can be dynamically aggregated together. Even if only one port can create the dynamic aggregation, that is the single port aggregation. In the dynamic aggregation, LACP protocol of the port is at the enable state.

### 2. The port state of the dynamic aggregation group

In dynamic aggregation group, the ports have two states: selected or standby. Both selected ports and standby ports can receive and send LACP protocol, but standby ports can not forward the data packets.

Because the limitation of the max port number in the aggregation group, if the current number of the member ports exceeds the limitation of the max port number, then the system of this end will negotiates with the other end to decide the port state according to the port ID. The negotiation steps are as follows:

Compare ID of the devices (the priority of the system + the MAC address of the system). First, compare the priority of the systems, if they are same, then compare the MAC address of the systems. The end with a small device ID has the high priority.

Compare the ID of the ports (the priority of the port + the ID of the port). For each port in the side of the device which has the high device priority, first, compare the priority of the ports, if the priorities are same, then compare the ID of the ports. The port with a small port ID is selected, and the others become the standby ports.

In an aggregation group, the port which has the smallest port ID and is at the selected



state will be the master port, the other ports at the selected state will be the member port.

## 6.3 Port Channel Configuration Task List

1. Create a port group in Global Mode
2. Add ports to the specified group from the Port Mode of respective ports
3. Enter port-channel configuration mode
4. Set load-balance method for port-group
5. Set the system priority of LACP protocol
6. Set the port priority of the current port in LACP protocol
7. Set the timeout mode of the current port in LACP protocol

### 1. Creating a port group

Command	Explanation
Global Mode	
<b>port-group</b> <port-group-number> <b>no port-group</b> <port-group-number>	Create or delete a port group.

### 2. Add physical ports to the port group

Command	Explanation
Port Mode	
<b>port-group</b> <port-group-number> mode {active   passive   on} <b>no port-group</b>	Add the ports to the port group and set their mode.

### 3. Enter port-channel configuration mode.

Command	Explanation
Global Mode	
<b>interface</b> port-channel <port-channel-number>	Enter port-channel configuration mode.

### 4. Set load-balance method for port-group

Command	Explanation
Aggregation port configuration mode	
<b>load-balance</b> {src-mac   dst-mac   dst-src-mac   src-ip   dst-ip   dst-src-ip   ingress-port	Set load-balance for port-group.

<b>dst-src-mac-ip }</b>	
-------------------------	--

#### 5. Set the system priority of LACP protocol

Command	Explanation
Global mode	
<b>lacp system-priority &lt;system-priority&gt;</b> <b>no lacp system-priority</b>	Set the system priority of LACP protocol, the no command restores the default value.

#### 6. Set the port priority of the current port in LACP protocol

Command	Explanation
Port mode	
<b>lacp port-priority &lt;port-priority&gt;</b> <b>no lacp port-priority</b>	Set the port priority in LACP protocol. The no command restores the default value.

#### 7. Set the timeout mode of the current port in LACP protocol

Command	Explanation
Port mode	
<b>lacp timeout {short   long}</b> <b>no lacp timeout</b>	Set the timeout mode in LACP protocol. The no command restores the default value.

## 6.4 Port Channel Examples

Scenario 1: Configuring Port Channel in LACP.

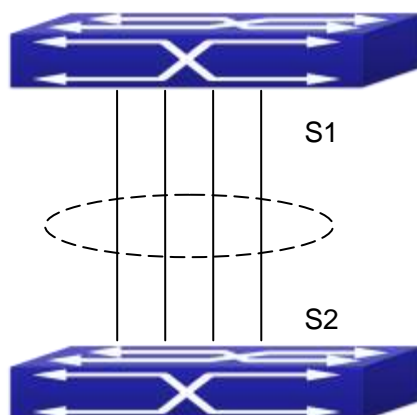

Fig 6-2 Configure Port Channel in LACP

The switches in the description below are all switch and as shown in the figure, ports 1, 2, 3, 4 of S1 are access ports and add them to group1 with active mode. Ports 6, 8, 9, 10 of S2 are access ports and add them to group2 with passive mode. All the ports should be connected with cables.

**The configuration steps are listed below:**

```
Switch1#config
```

```
Switch1(config)#interface ethernet 1/0/1-4
```

```
Switch1(Config-If-Port-Range)#port-group 1 mode active
```

```
Switch1(Config-If-Port-Range)#exit
```

```
Switch1(config)#interface port-channel 1
```

```
Switch1(Config-If-Port-Channel1)#
```

```
Switch2#config
```

```
Switch2(config)#port-group 2
```

```
Switch2(config)#interface ethernet 1/0/6
```

```
Switch2(Config-If-Ethernet1/0/6)#port-group 2 mode passive
```

```
Switch2(Config-If-Ethernet1/0/6)#exit
```

```
Switch2(config)#interface ethernet 1/0/8-10
```

```
Switch2(Config-If-Port-Range)#port-group 2 mode passive
```

```
Switch2(Config-If-Port-Range)#exit
```

```
Switch2(config)#interface port-channel 2
```

```
Switch2(Config-If-Port-Channel2)#
```

**Configuration result:**

Shell prompts ports aggregated successfully after a while, now ports 1, 2, 3, 4 of S1 form an aggregated port named "Port-Channel1", ports 6, 8, 9, 10 of S2 form an

aggregated port named "Port-Channel2"; can be configured in their respective aggregated port mode.

Scenario 2: Configuring Port Channel in ON mode.

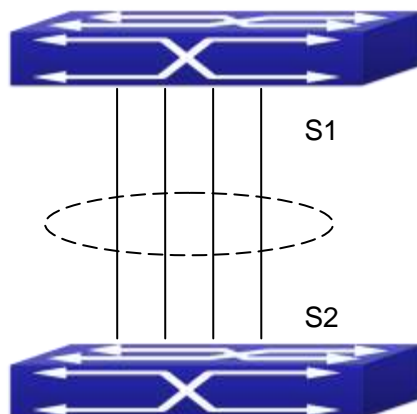

Fig 6-3 Configure Port Channel in ON mode

As shown in the figure, ports 1, 2, 3, 4 of S1 are access ports and add them to group1 with "on" mode. Ports 6, 8, 9, 10 of S2 are access ports and add them to group2 with "on" mode.

**The configuration steps are listed below:**

```
Switch1#config
Switch1(config)#interface ethernet 1/0/1
Switch1(Config-If-Ethernet1/0/1)#port-group 1 mode on
Switch1(Config-If-Ethernet1/0/1)#exit
Switch1(config)#interface ethernet 1/0/2
Switch1 (Config-If-Ethernet1/0/2)#port-group 1 mode on
Switch1 (Config-If-Ethernet1/0/2)#exit
Switch1 (config)#interface ethernet 1/0/3
Switch1 (Config-If-Ethernet1/0/3)#port-group 1 mode on
Switch1 (Config-If-Ethernet1/0/3)#exit
Switch1 (config)#interface ethernet 1/0/4
Switch1 (Config-If-Ethernet1/0/4)#port-group 1 mode on
Switch1 (Config-If-Ethernet1/0/4)#exit

Switch2#config
Switch2(config)#port-group 2
Switch2(config)#interface ethernet 1/0/6
Switch2 (Config-If-Ethernet1/0/6)#port-group 2 mode on
```

```
Switch2 (Config-If-Ethernet1/0/6)#exit
Switch2 (config)#interface ethernet 1/0/8-10
Switch2(Config-If-Port-Range)#port-group 2 mode on
Switch2(Config-If-Port-Range)#exit
```

**Configuration result:**

Add ports 1, 2, 3, 4 of S1 to port-group1 in order, and we can see a group in “on” mode is completely joined forcedly, switch in other ends won’t exchange LACP PDU to complete aggregation. Aggregation finishes immediately when the command to add port 1/0/2 to port-group 1 is entered, port 1 and port 2 aggregate to be port-channel 1, when port 1/0/3 joins port-group 1, port-channel 1 of port 1 and 2 are ungrouped and re-aggregate with port 3 to form port-channel 1, when port 1/0/4 joins port-group 1, port-channel 1 of port 1, 2 and 3 are ungrouped and re-aggregate with port 4 to form port-channel 1. (It should be noted that whenever a new port joins in an aggregated port group, the group will be ungrouped first and re-aggregated to form a new group.) Now all four ports in both S1 and S2 are aggregated in “on” mode and become an aggregated port respectively.

## 6.5 Port Channel Troubleshooting

If problems occur when configuring port aggregation, please first check the following for causes.

- ☞ Ensure all ports in a port group have the same properties, i.e., whether they are in full-duplex mode, forced to the same speed, and have the same VLAN properties, etc. If inconsistency occurs, make corrections.
- ☞ Some commands cannot be used on a port in port-channel, such as arp, bandwidth, ip, ip-forward, etc.

# Chapter 7 MTU Configuration

## 7.1 Introduction to MTU

So far the Jumbo (Jumbo Frame) has not reach a determined standard in the industry (including the format and length of the frame). Normally frames sized within 1519-9000 should be considered jumbo frame. Networks with jumbo frames will increase the speed of the whole network by 2% to 5%. Technically the Jumbo is just a lengthened frame sent and received by the switch. However considering the length of Jumbo frames, they will not be sent to CPU. We discard the Jumbo frames sent to CPU in the packet receiving process.

## 7.2 MTU Configuration Task Sequence

1. Configure enable MTU function

### 1. Configure enable MTU function

Command	Explanation
Global Mode	
<b>mtu [&lt;mtu-value&gt;]</b> <b>no mtu enable</b>	Configure the MTU size of JUMBO frame, enable the receiving/sending function of JUMBO frame. The no command disables sending and receiving function of MTU frames.

# Chapter 8 EFM OAM Configuration

## 8.1 Introduction to EFM OAM

Ethernet is designed for Local Area Network at the beginning, but link length and network scope is extended rapidly while Ethernet is also applied to Metropolitan Area Network and Wide Area Network along with development. Due to lack the effectively management mechanism, it affects Ethernet application to Metropolitan Area Network and Wide Area Network, implementing OAM on Ethernet becomes a necessary development trend.

There are four protocol standards about Ethernet OAM, they are 802.3ah (EFM OAM), 802.3ag (CFM), E-LMI and Y.1731. EFM OAM and CFM are set for IEEE organization. EFM OAM works in data link layer to validly discover and manage the data link status of rock-bottom. Using EFM OAM can effectively advance management and maintenance for Ethernet to ensure the stable network operation. CFM is used for monitoring the whole network connectivity and locating the fault in access aggregation network layer. Compare with CFM, Y.1731 standard set by ITU (International Telecommunications Union) is more powerful. E-LMI standard set by MEF is only applied to UNI. So above protocols can be used to different network topology and management, between them exist the complementary relation.

EFM OAM (Ethernet in the First Mile Operation, Administration and Maintenance) works in data link layer of OSI model to implement the relative functions through OAM sublayer, figure is as bleow:

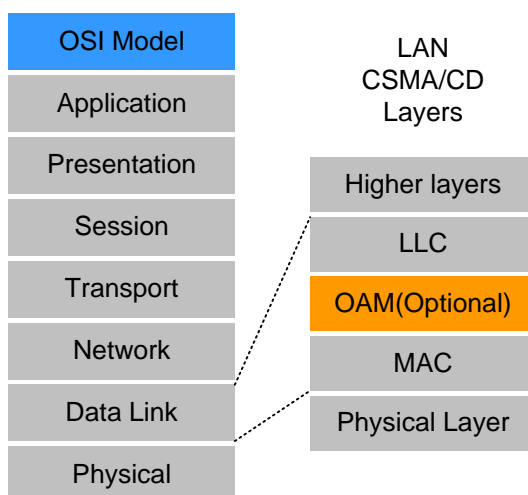

Fig 8-1 OAM location in OSI model

OAM protocol data units (OAMPDU) use destination MAC address 01-80-c2-00-00-02 of protocol, the max transmission rate is 10Pkt/s.

EFM OAM is established on the basis of OAM connection, it provides a link operation management mechanism such as link monitoring, remote fault detection and remote loopback testing, the simple introduction for EFM OAM in the following:

#### 1. Ethernet OAM connection establishment

Ethernet OAM entity discovers remote OAM entities and establishes sessions with them by exchanging Information OAMPDUs. EFM OAM can operate in two modes: active mode and passive mode. One session can only be established by the OAM entity working in the active mode and ones working in the passive mode need to wait until it receives the connection request. After an Ethernet OAM connection is established, the Ethernet OAM entities on both sides exchange Information OAMPDUs continuously to keep the valid Ethernet OAM connection. If an Ethernet OAM entity receives no Information OAMPDU for five seconds, the Ethernet OAM connection is disconnected.

#### 2. Link Monitoring

Fault detection in an Ethernet is difficult, especially when the physical connection in the network is not disconnected but network performance is degrading gradually. Link monitoring is used to detect and discover link faults in various environments. EFM OAM implements link monitoring through the exchange of Event Notification OAMPDUs. When detecting a link error event, the local OAM entity sends an Event Notification OAMPDU to notify the remote OAM entity. At the same time it will log information and send SNMP Trap to the network management system. While OAM entity on the other side receives the notification, it will also log and report it. With the log information, network administrators can keep track of network status in time.

The link event monitored by EFM OAM means that the link happens the error event, including Errored symbol period event, Errored frame event, Errored frame period event, Errored frame seconds event.

Errored symbol period event: The errored symbol number can not be less than the low threshold. (Symbol: the min data transmission unit of physical medium. It is unique for coding system, the symbols may be different for different physical mediums, symbol rate means the changed time of electron status per second. )

Errored frame period event: Specifying N is frame period, the errored frame number within the period of receiving N frames can not be less than the low threshold. (Errored frame: Receiving the errored frame detected by CRC.)

Errored frame event: The number of detected error frames over M seconds can not be less than the low threshold.



Errored frame seconds event: The number of error frame seconds detected over M seconds can not be less than the low threshold. (Errored frame second: Receiving an errored frame at least in a second.)

### 3. Remote Fault Detection

In a network where traffic is interrupted due to device failures or unavailability, the flag field defined in Ethernet OAMPDUs allows an Ethernet OAM entity to send fault information to its peer. As Information OAMPDUs are exchanged continuously across established OAM connections, an Ethernet OAM entity can inform one of its OAM peers of link faults through Information OAMPDUs. Therefore, the network administrator can keep track of link status in time through the log information and troubleshoot in time.

There are three kinds of link faults for Information OAMPDU, they are Critical Event, Dying Gasp and Link Fault, and their definitions are different for each manufacturer, here the definitions are as below:

Critical Event: EFM OAM function of port is disabled.

Link Fault: The number of unidirectional operation or fault can not be less than the high threshold in local. Unidirectional Operation means unidirectional link can not work normally on full-duplex link without autonegotiation. EFM OAM can detect the fault and inform the remote OAM peers through sending Information OAMPDU.

Dying Gasp: There is no definition present. Although device does not generate Dying Gasp OAMPDU, it still receives and processes such OAMPDU sent by its peer.

### 4. Remote loopback testing

Remote loopback testing is available only after an Ethernet OAM connection is established. With remote loopback enabled, operating Ethernet OAM entity in active mode issues remote loopback requests and the peer responds to them. If the peer operates in loopback mode, it returns all packets except Ethernet OAMPDUs to the senders along the original paths. Performing remote loopback testing periodically helps to detect network faults in time. Furthermore, performing remote loopback testing by network segments helps to locate network faults. Note: The communication will not be processed normally in remote loopback mode.

Typical EFM OAM application topology is in the following, it is used for point-to-point link and emulational IEEE 802.3 point-to-point link. Device enables EFM OAM through point-to-point connection to monitor the link fault in the First Mile with Ethernet access. For user, the connection between user to telecommunication is “the First Mile”, for service provider, it is “the Last Mile”.

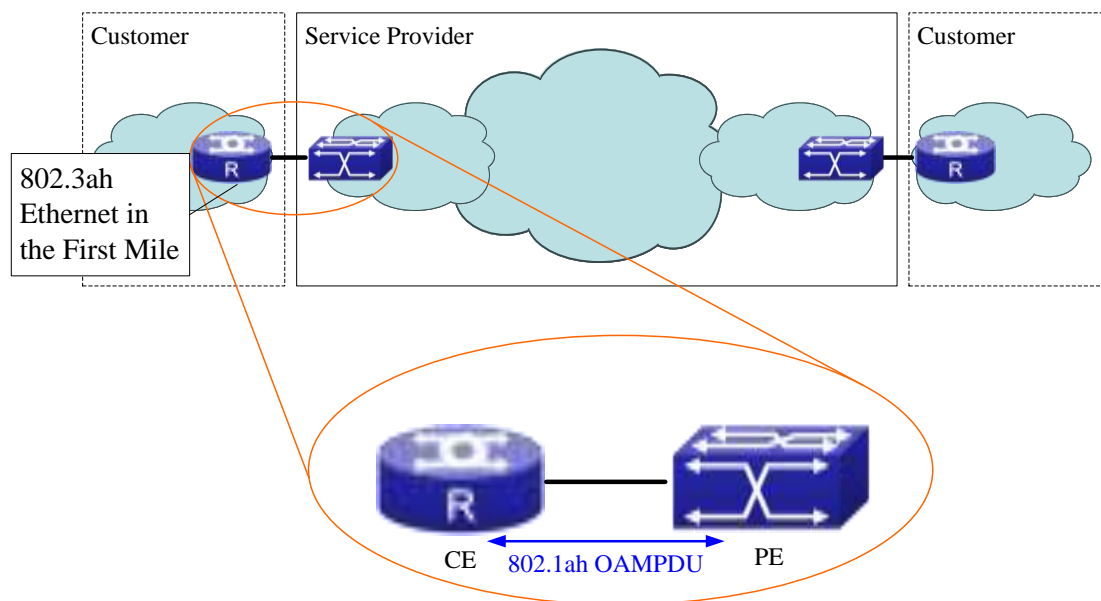

Fig 8-2 Typical OAM application topology

## 8.2 EFM OAM Configuration

EFM OAM configuration task list

1. Enable EFM OAM function of port
2. Configure link monitor
3. Configure remote failure

Note: it needs to enable OAM first when configuring OAM parameters.

### 1. Enable EFM OAM function of port

Command	Explanation
Port mode	
<b>ethernet-oam mode {active   passive}</b>	Configure work mode of EFM OAM, default is active mode.
<b>ethernet-oam</b> <b>no ethernet-oam</b>	Enable EFM OAM of port, no command disables EFM OAM of port.
<b>ethernet-oam period &lt;seconds&gt;</b> <b>no ethernet-oam period</b>	Configure transmission period of OAMPDU (optional), no command restores the default value.
<b>ethernet-oam timeout &lt;seconds&gt;</b> <b>no ethernet-oam timeout</b>	Configure timeout of EFM OAM connection, no command restores the default value.

## 2. Configure link monitor

Command	Explanation
Port mode	
<b>ethernet-oam link-monitor</b> <b>no ethernet-oam link-monitor</b>	Enable link monitor of EFM OAM, no command disables link monitor.
<b>ethernet-oam errored-symbol-period</b> <b>{threshold low &lt;low-symbols&gt;   window &lt;seconds&gt;}</b> <b>no ethernet-oam errored-symbol-period</b> <b>{threshold low   window }</b>	Configure the low threshold and window period of errored symbol period event, no command restores the default value. (optional)
<b>ethernet-oam errored-frame-period</b> <b>{threshold low &lt;low-frames&gt;   window &lt;seconds&gt;}</b> <b>no ethernet-oam errored-frame-period</b> <b>{threshold low   window }</b>	Configure the low threshold and window period of errored frame period event, no command restores the default value.
<b>ethernet-oam errored-frame {threshold low &lt;low-frames&gt;   window &lt;seconds&gt;}</b> <b>no ethernet-oam errored-frame {threshold low   window }</b>	Configure the low threshold and window period of errored frame event, no command restores the default value. (optional)
<b>ethernet-oam errored-frame-seconds</b> <b>{threshold low &lt;low-frame-seconds&gt;   window &lt;seconds&gt;}</b> <b>no ethernet-oam errored-frame-seconds</b> <b>{threshold low   window }</b>	Configure the low threshold and window period of errored frame seconds event, no command restores the default value. (optional)

## 3. Configure remote failure

Command	Explanation
Port mode	
<b>ethernet-oam remote-failure</b> <b>no ethernet-oam remote-failure</b>	Enable remote failure detection of EFM OAM (failure means critical-event or link-fault event of the local), no command disables the function. (optional)

<b>ethernet-oam errored-symbol-period threshold high {high-symbols   none}</b> <b>no ethernet-oam errored-symbol-period threshold high</b>	Configure the high threshold of errored symbol period event, no command restores the default value. (optional)
<b>ethernet-oam errored-frame-period threshold high {high-frames   none}</b> <b>no ethernet-oam errored-frame-period threshold high</b>	Configure the high threshold of errored frame period event, no command restores the default value. (optional)
<b>ethernet-oam errored-frame threshold high {high-frames   none}</b> <b>no ethernet-oam errored-frame threshold high</b>	Configure the high threshold of errored frame event, no command restores the default value. (optional)
<b>ethernet-oam errored-frame-seconds threshold high {high-frame-seconds   none}</b> <b>no ethernet-oam errored-frame-seconds threshold high</b>	Configure the high threshold of errored frame seconds event, no command restores the default value. (optional)

### 8.3 EFM OAM Example

Example:

CE and PE devices with point-to-point link enable EFM OAM to monitor “the First Mile” link performance. It will report the log information to network management system when occurring fault event and use remote loopback function to detect the link in necessary instance

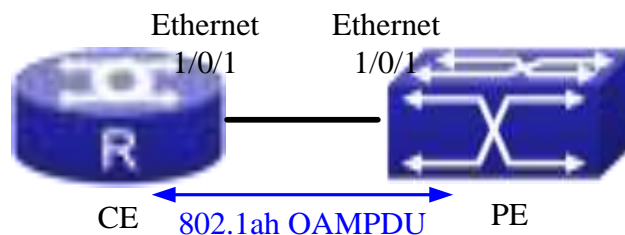

Fig 8-3 Typical OAM application topology

Configuration procedure: (Omitting SNMP and Log configuration in the following)

Configuration on CE:

```
CE(config)#interface ethernet1/0/1
```

```
CE (config-if-ethernet1/0/1)#ethernet-oam mode passive
```

```
CE (config-if-ethernet1/0/1)#ethernet-oam
```

```
CE (config-if-ethernet1/0/1)#ethernet-oam remote-loopback supported
```

Other parameters use the default configuration.

Configuration on PE:

```
PE(config)#interface ethernet 1/0/1
```

```
PE (config-if-ethernet1/0/1)#ethernet-oam
```

Other parameters use the default configuration.

Execute the following command when using remote loopback.

```
PE(config-if-ethernet1/0/1)#ethernet-oam remote-loopback
```

Execute the following command to make one of OAM peers exiting OAM loopback after complete detection.

```
PE(config-if-ethernet1/0/1)# no ethernet-oam remote-loopback
```

Execute the following command without supporting remote loopback.

```
CE(config-if-ethernet1/0/1)#no ethernet-oam remote-loopback supported
```

## 8.4 EFM OAM Troubleshooting

When using EFM OAM, it occurs the problem, please check whether the problem is resulted by the following reasons:

- ☞ Check whether OAM entities of two peers of link in passive mode. If so, EFM OAM connection can not be established between two OAM entities.
- ☞ Ensuring SNMP configuration is correct, or else errored event can not be reported to network management system.
- ☞ Link does not normally communicate in OAM loopback mode, it should cancel remote loopback in time after detect the link performance.
- ☐ Ensuring the used board supports remote loopback function.
- ☐ Port should not configure STP, MRPP, ULPP, Flow Control, loopback detection functions after it enables OAM loopback function, because OAM remote loopback function and these functions are mutually exclusive.
- ☞ Check the port negotiation status is auto negotiation status or not in both EFM OAM ends of link, the port in auto negotiation status can not be UP.
- ☐

# Chapter 9 PORT SECURITY

## 9.1 Introduction to PORT SECURITY

Port security is a MAC address-based security mechanism for network access controlling. It is an extension to the existing 802.1x authentication and MAC authentication. It controls the access of unauthorized devices to the network by checking the source MAC address of the received frame and the access to unauthorized devices by checking the destination MAC address of the sent frame. With port security, you can define various port security modes to make that a device learns only legal source MAC addresses, so as to implement corresponding network security management. After port security is enabled, the device detects an illegal frame, it triggers the corresponding port security feature and takes a pre-defined action automatically. This reduces user's maintenance workload and greatly enhances system security.

## 9.2 PORT SECURITY Configuration Task List

### 1. Basic configuration for PORT SECURITY

Command	Explanation
Port mode	
<b>switchport port-security</b> <b>no switchport port-security</b>	Configure port-security of the interface.
<b>switchport port-security mac-address</b> <b>&lt;mac-address&gt; [vlan &lt;vlan-id&gt;]</b> <b>no switchport port-security mac-address</b> <b>&lt;mac-address&gt; [vlan &lt;vlan-id&gt;]</b>	Configure the static security MAC of the interface.
<b>switchport port-security maximum &lt;value&gt; [vlan</b> <b>&lt;vlan-list&gt;]</b> <b>no switchport port-security maximum &lt;value&gt;</b> <b>[vlan &lt;vlan-list&gt;]</b>	Configure the maximum number of the security MAC address allowed by the interface.
<b>switchport port-security violation {protect  </b> <b>recovery   restrict   shutdown}</b> <b>no switchport port-security violation</b>	When exceeding the maximum number of the configured MAC addresses, MAC address accessing the interface does not belongs to this interface in MAC address

	table or a MAC address is configured to several interfaces in same VLAN, both of them will violate the security of the MAC address.
<b>switchport port-security aging {static   time &lt;value&gt;   type {absolute   inactivity}}</b> <b>no switchport port-security violation aging {static   time   type}</b>	Enable port-security aging entry of the interface, specify aging time or aging type.
Admin mode	
<b>clear port-security {all   configured   dynamic   sticky} [[address &lt;mac-addr&gt;   interface &lt;interface-id&gt;] [vlan &lt;vlan-id&gt; ]]</b>	Clear the secure MAC entry of the interface.
<b>show port-security [interface &lt;interface-id&gt;] [address   vlan]</b>	Show port-security configuration.

### 9.3 Example of PORT SECURITY

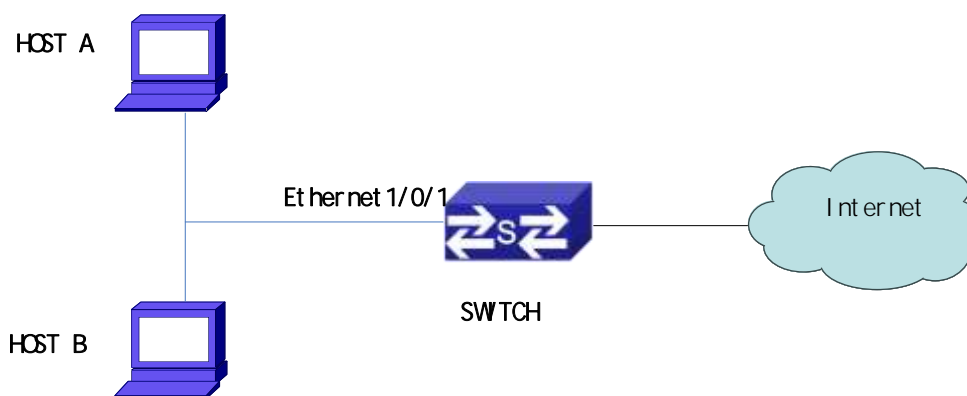

Fig 9-1 Typical topology chart for port security

When the interface enabled Port security function, configure the maximum number of the secure MAC addresses allowed by a interface to be 10, the interface allows 10 users to access the internet at most. If it exceeds the maximum number, the new user cannot access the internet, so that it not only limit the user's number but also access the internet safely. If configuring the maximum number of the secure MAC addresses as 1, only HOST A or HOST B is able to access the internet.

Configuration process:

#Configure the switch.

Switch(config)#interface Ethernet 1/0/1

```
Switch(config-if-ethernet1/0/1)#switchport port-security
Switch(config-if-ethernet1/0/1)#switchport port-security maximum 10
Switch(config-if-ethernet1/0/1)#exit
Switch(config)#
```

## 9.4 PORT SECURITY Troubleshooting

If problems occur when configuring PORT SECURITY, please check whether the problem is caused by the following reasons:

- ☞ Check whether PORT SECURITY is enabled normally
- ☞ Check whether the valid maximum number of MAC addresses is configured



# Chapter 10 DDM Configuration

## 10.1 Introduction to DDM

### 10.1.1 Brief Introduction to DDM

DDM (Digital Diagnostic Monitor) makes the detailed digital diagnostic function standard in SFF-8472 MSA. It set that the parameter signal is monitored and make it to digitize on the circuit board of the inner module. After that, providing the demarcated result or the digitize measure result and the demarcate parameter which are saved in the standard memory framework, so as to expediently read by serial interface with double cables.

Normally, intelligent fiber modules support Digital Diagnostic function. Network management units is able to monitor the parameters (temperature, voltage, bias current, tx power and rx power) of the fiber module to obtain theirs thresholds and the real-time state of the current fiber module by the inner MCU of the fiber module. That is able to help the network management units to locate the fault in the fiber link, reduce the maintenance workload and enhance the system reliability.

DDM applications are shown in the following:

#### 1. Module lifetime forecast

Monitoring the bias current is able to forecast the laser lifetime. Administrator is able to find some potential problems by monitoring voltage and temperature of the module.

( 1 ) High Vcc voltage will result in the breakdown CMOS, low Vcc voltage will result in the abnormity work.

( 2 ) High rx power will damage the receiving module, low rx power will result that the receiving module cannot work normally.

( 3 ) High temperature will result in the fast aging of the hardware.

( 4 ) Monitoring the received fiber power to monitor the capability of the link and the remote switch.

#### 2. Fault location

In fiber link, locating the fault is important to the fast overload of the service, fault isolation is able to help administrator to fast locate the location of the link fault within the

module (local module or remote module) or on the link, it also reduce the time for restoring the fault of the system.

Analyzing warning and alarm status of real-time parameters (temperature, voltage, bias current, tx power and rx power) can fast locate the fault through Digital Diagnostic function. Besides, the state of Tx Fault and Rx LOS is important for analyzing the fault.

### 3. Compatibility verification

Compatibility verification is used to analyze whether the environment of the module accords the data manual or it is compatible with the corresponding standard, because the module capability is able to be ensured only in the compatible environment. Sometimes, environment parameters exceed the data manual or the corresponding standard, it will make the falling of the module capability that result in the transmission error.

Environment is not compatible with the module are as below:

- ( 1 ) Voltage exceeds the set range
- ( 2 ) Rx power is overload or is under the sensitivity of the transceiver
- ( 3 ) Temperature exceeds the range of the running temperature

## 10.1.2 DDM Function

DDM descriptions are shown in the following:

### 1. Show the monitoring information of the transceiver

Administrator is able to know the current working state of the transceiver and find some potential problems through checking the real-time parameters (including TX power, RX power, Temperature, Voltage, Bias current) and querying the monitoring information (such as warning, alarm, real-time state and threshold, and so on). Besides, checking the fault information of the fiber module helps administrator to fast locate the link fault and saves the restored time.

### 2. Threshold defined by the user

For real-time parameters (TX power, RX power, Temperature, Voltage, Bias current), there are fixed thresholds. Because the user's environments are difference, the users is able to define the threshold (including high alarm, low alarm, high warn, low warn) to flexibly monitor the working state of the transceiver and find the fault directly.

The thresholds configured by the user and the manufacturer can be shown at the same time. When the threshold defined by the user is irrational, it will prompt the user and automatically process alarm or warning according to the default threshold. (the user is able to restore all thresholds to the default thresholds or restore a threshold to the default threshold)

Threshold rationality: high/low warn should be between high alarm and low alarm and high threshold should be higher than low threshold, namely, high alarm $\geq$  high warn $\geq$  low warn $\geq$  low alarm.

For fiber module, verification mode of the receiving power includes inner verification and outer verification which are decided by the manufacturer. Besides the verification mode of the real-time parameters and the default thresholds are same.

### 3. Transceiver monitoring

Besides checking the real-time working state of the transceiver, the user needs to monitor the detailed status, such as the former abnormality time and the abnormality type. Transceiver monitoring helps the user to find the former abnormality status through checking the log and query the last abnormality status through executing the commands. When the user finds the abnormality information of the fiber module, the fiber module information may be remonitored after processing the abnormality information, here, the user is able to know the abnormality information and renew the monitoring.

## 10.2 DDM Configuration Task List

DDM configuration task list:

1. Show the real-time monitoring information of the transceiver
2. Configure the alarm or warning thresholds of each parameter for the transceiver
3. Configure the state of the transceiver monitoring
  - ( 1 ) Configure the interval of the transceiver monitoring
  - ( 2 ) Configure the enable state of the transceiver monitoring
  - ( 3 ) Show the information of the transceiver monitoring
  - ( 4 ) Clear the information of the transceiver monitoring

### 1. Show the real-time monitoring information of the transceiver

Command	Explanation
User mode, admin mode and global mode	
<b>show transceiver [interface ethernet &lt;interface-list&gt;][detail]</b>	Show the monitoring of the transceiver.

## 2. Configure the alarm or warning thresholds of each parameter for the transceiver

Command	Explanation
Port mode	
<b>transceiver threshold {default   {temperature   voltage   bias   rx-power   tx-power} {high-alarm   low-alarm   high-warn   low-warn} {&lt;value&gt;   default}}</b>	Set the threshold defined by the user.

## 3. Configure the state of the transceiver monitoring

### (1) Configure the interval of the transceiver monitoring

Command	Explanation
Global mode	
<b>transceiver-monitoring interval &lt;minutes&gt; no transceiver-monitoring interval</b>	Set the interval of the transceiver monitor. The no command sets the interval to be the default interval of 15 minutes.

### ( 2 ) Configure the enable state of the transceiver monitoring

Command	Explanation
Port mode	
<b>transceiver-monitoring {enable   disable}</b>	Set whether the transceiver monitoring is enabled. Only the port enables the transceiver monitoring, the system records the abnormality state. After the port disables the function, the abnormality information will be clear.

**( 3 ) Show the information of the transceiver monitoring**

Command	Explanation
Admin mode and global mode	
<b>show transceiver threshold-violation</b> <b>[interface ethernet &lt;interface-list&gt;]</b>	Show the information of the transceiver monitoring, including the last threshold-violation information, the interval of the current transceiver monitoring and whether the port enables the transceiver monitoring.

**( 4 ) Clear the information of the transceiver monitoring**

Command	Explanation
Admin mode	
<b>clear transceiver threshold-violation</b> <b>[interface ethernet &lt;interface-list&gt;]</b>	Clear the threshold violation of the transceiver monitor.

**10.3 Examples of DDM**

Example1:

Ethernet 21 and Ethernet 23 are inserted the fiber module with DDM, Ethernet 24 is inserted the fiber module without DDM, Ethernet 22 does not insert any fiber module, show the DDM information of the fiber module.

a、 Show the information of all interfaces which can read the real-time parameters normally,(No fiber module is inserted or the fiber module is not supported, the information will not be shown), for example:

Switch#show transceiver

Interface	Temp( )	Voltage( V )	Bias( mA )	RX Power( dBm )	TX Power( dBm )
1/0/21	33	3.31	6.11	-30.54(A-)	-6.01
1/0/23	33	5.00 ( W+ )	6.11	-20.54(W-)	-6.02

b、 Show the information of the specified interface. (N/A means no fiber module is inserted

or does not support the fiber module), for example:

Switch#show transceiver interface ethernet 1/0/21-22;23

Interface	Temp( )	Voltage( V )	Bias( mA )	RX Power( dBM )	TX Power( dBM )
1/0/21	33	3.31	6.11	-30.54(A-)	-6.01
1/0/22	N/A	N/A	N/A	N/A	N/A
1/0/23	33	5.00 ( W+ )	6.11	-20.54(W-)	-6.02

c、 Show the detailed information, including base information, parameter value of the real-time monitoring, warning, alarm, abnormality state, threshold information and the serial number, for example:

Switch#show transceiver interface ethernet 1/0/21-22;24 detail

Ethernet 1/0/21 transceiver detail information:

Base information:

SFP found in this port, manufactured by company, on Sep 29 2010.

Type is 1000BASE-SX. Serial Number is 1108000001.

Link length is 550 m for 50um Multi-Mode Fiber.

Link length is 270 m for 62.5um Multi-Mode Fiber.

Nominal bit rate is 1300 Mb/s, Laser wavelength is 850 nm.

Brief alarm information:

RX loss of signal

Voltage high

RX power low

Detail diagnostic and threshold information:

	Diagnostic		Threshold		
	Realtime Value	High Alarm	Low Alarm	High Warn	Low Warn
	-----	-----	-----	-----	-----
Temperature ( )	33	70	0	70	0
Voltage ( V )	7.31(A+)	5.00	0.00	5.00	0.00
Bias current ( mA )	6.11(W+)	10.30	0.00	5.00	0.00
RX Power( dBM )	-30.54(A-)	9.00	-25.00	9.00	-25.00
TX Power( dBM )	-6.01	9.00	-25.00	9.00	-25.00

Ethernet 1/0/22 transceiver detail information: N/A

Ethernet 1/0/24 transceiver detail information:

Base information:

SFP found in this port, manufactured by company, on Sep 29 2010.

Type is 1000BASE-SX. Serial Number is 1108000001.

Link length is 550 m for 50um Multi-Mode Fiber.

Link length is 270 m for 62.5um Multi-Mode Fiber.

Nominal bit rate is 1300 Mb/s, Laser wavelength is 850 nm.

Brief alarm information: N/A

Detail diagnostic and threshold information: N/A

Explanation: If the serial number is 0, it means that it is not specified as bellow:

SFP found in this port, manufactured by company, on Sep 29 2010.

Type is 1000BASE-SX. Serial Number is not specified.

Link length is 550 m for 50um Multi-Mode Fiber.

Link length is 270 m for 62.5um Multi-Mode Fiber.

Nominal bit rate is 1300 Mb/s, Laser wavelength is 850 nm.

Example2:

Ethernet 21 is inserted the fiber module with DDM. Configure the threshold of the fiber module after showing the DDM information.

Step1: Show the detailed DDM information.

Switch#show transceiver interface ethernet 1/0/21 detail

Ethernet 1/0/21 transceiver detail information:

Base information:

.....

Brief alarm information:

RX loss of signal

Voltage high

RX power low

Detail diagnostic and threshold information:

	Diagnostic			Threshold	
	Realtime Value	High Alarm	Low Alarm	High Warn	Low Warn
	-----	-----	-----	-----	-----
Temperature ( )	33	70	0	70	0
Voltage ( V )	7.31(A+)	5.00	0.00	5.00	0.00
Bias current ( mA )	6.11(W+)	10.30	0.00	5.00	0.00

RX Power ( dBM )	-30.54(A-)	9.00	-25.00	9.00	-25.00
TX Power ( dBM )	-13.01	9.00	-25.00	9.00	-25.00

Step2: Configure the tx-power threshold of the fiber module, the low-warning threshold is -12, the low-alarm threshold is -10.00.

Switch#config

Switch(config)#interface ethernet 1/0/21

Switch(config-if-ethernet1/0/21)#transceiver threshold tx-power low-warning -12

Switch(config-if-ethernet1/0/21)#transceiver threshold tx-power low-alarm -10.00

Step3: Show the detailed DDM information of the fiber module. The alarm uses the threshold configured by the user, the threshold configured by the manufacturer is labeled with the bracket. There is the alarm with 'A-' due to -13.01 is less than -12.00.

Switch#show transceiver interface ethernet 1/0/21 detail

Ethernet 1/0/21 transceiver detail information:

Base information:

.....

Brief alarm information:

RX loss of signal

Voltage high

RX power low

TX power low

Detail diagnostic and threshold information:

	Diagnostic			Threshold	
	Realtime Value	High Alarm	Low Alarm	High Warn	Low Warn
	-----	-----	-----	-----	-----
Temperature ( )	33	70	0	70	0
Voltage ( V )	7.31(A+)	5.00	0.00	5.00	0.00
Bias current ( mA )	6.11(W+)	10.30	0.00	5.00	0.00
RX Power ( dBM )	-30.54(A-)	9.00	-25.00	9.00	-25.00
TX Power ( dBM )	-13.01(A-)	9.00	-12.00(-25.00)	9.00	-10.00(-25.00)

Example3:



Ethernet 21 is inserted the fiber module with DDM. Enable the transceiver monitoring of the port after showing the transceiver monitoring of the fiber module.

Step1: Show the transceiver monitoring of the fiber module. Both ethernet 21 and ethernet 22 do not enable the transceiver monitoring, its interval is set to 30 minutes.

```
Switch(config)#show transceiver threshold-violation interface ethernet 1/0/21-22
```

Ethernet 1/0/21 transceiver threshold-violation information:

Transceiver monitor is disabled. Monitor interval is set to 30 minutes.

The last threshold-violation doesn't exist.

Ethernet 1/0/22 transceiver threshold-violation information:

Transceiver monitor is disabled. Monitor interval is set to 30 minutes.

The last threshold-violation doesn't exist.

Step2: Enable the transceiver monitoring of ethernet 21.

```
Switch(config)#interface ethernet 1/0/21
```

```
Switch(config-if-ethernet1/0/21)#transceiver-monitoring enable
```

Step3: Show the transceiver monitoring of the fiber module. In the following configuration, ethernet 21 enabled the transceiver monitoring, the last threshold-violation time is Jan 02 11:00:50 2011, the detailed DDM information exceeding the threshold is also shown.

```
Switch(config-if-ethernet1/0/21)#quit
```

```
Switch(config)#show transceiver threshold-violation interface ethernet 1/0/21-22
```

Ethernet 1/0/21 transceiver threshold-violation information:

Transceiver monitor is enabled. Monitor interval is set to 30 minutes.

The current time is Jan 02 12:30:50 2011.

The last threshold-violation time is Jan 02 11:00:50 2011.

Brief alarm information:

RX loss of signal

RX power low

Detail diagnostic and threshold information:

	Diagnostic			Threshold	
	Realtime Value	High Alarm	Low Alarm	High Warn	Low Warn
	-----	-----	-----	-----	-----
Temperature ( )	33	70	0	70	0
Voltage ( V )	7.31	10.00	0.00	5.00	0.00
Bias current ( mA )	3.11	10.30	0.00	5.00	0.00

---

RX Power ( dBM )	-30.54(A-)	9.00	-25.00(-34)	9.00	-25.00
TX Power ( dBM )	-1.01	9.00	-12.05	9.00	-10.00

Ethernet 1/0/22 transceiver threshold-violation information:

Transceiver monitor is disabled. Monitor interval is set to 30 minutes.

The last threshold-violation doesn't exist.

## 10.4 DDM Troubleshooting

If problems occur when configuring DDM, please check whether the problem is caused by the following reasons:

- Ensure that the transceiver of the fiber module has been inserted fast on the port, or else DDM configuration will not be shown.
- Ensure that SNMP configuration is valid, or else the warning event cannot inform the network management system.
- Because only some boards and box switches support SFP with DDM or XFP with DDM, ensure the used board and switch support the corresponding function.
- When using **show transceiver** command or **show transceiver detail** command, it cost much time due to the switch will check all ports, so it is recommended to query the monitoring information of the transceiver on the specified port.
- Ensure the threshold defined by the user is valid. When any threshold is error, the transceiver will give an alarm according to the default setting automatically.

# Chapter 11 LLDP-MED

## 11.1 Introduction to LLDP-MED

LLDP-MED (Link Layer Discovery Protocol-Media Endpoint Discovery) based on 802.1AB LLDP (Link Layer Discovery Protocol) of IEEE. LLDP provides a standard link layer discovery mode, it sends local device information (including its major capability, management IP address, device ID and port ID) as TLV (type/length/value) triplets in LLDPDU (Link Layer Discovery Protocol Data Unit) to the direct connection neighbors. The device information received by the neighbors will be stored with a standard management information base (MIB). This allows a network management system to quickly detect and identify the communication status of the link.

In 802.1AB LLDP, there is no transmission and management about the voice device information. To deploy and manage voice device expediently, LLDP-MED TLVs provide multiple information, such as PoE (Power over Ethernet), network policy, and the location information of the emergent telephone service.

## 11.2 LLDP-MED Configuration Task Sequence

### 1. Basic LLDP-MED configuration

Command	Explanation
Port mode	
<b>lldp transmit med tlv all</b> <b>no lldp transmit med tlv all</b>	Configure the specified port to send all LLDP-MED TLVs. The no command disables the function.
<b>lldp transmit med tlv capability</b> <b>no lldp transmit med tlv capability</b>	Configure the specified port to send LLDP-MED Capability TLV. The no command disables the capability.
<b>lldp transmit med tlv networkPolicy</b> <b>no lldp transmit med tlv networkPolicy</b>	Configure the specified port to send LLDP-MED Network Policy TLV. The no command disables the capability.
<b>lldp transmit med tlv extendPoe</b>	Configure the specified port

<p><b>no lldp transmit med tlv extendPoe</b></p>	<p>to send LLDP-MED Extended Power-Via-MDI TLV. The no command disables the capability.</p>
<p><b>lldp transmit med tlv location</b> <b>no lldp transmit med tlv location</b></p>	<p>Configure the specified port to send LLDP-MED Location Identification TLV. The no command disables the capability.</p>
<p><b>lldp transmit med tlv inventory</b> <b>no lldp transmit med tlv inventory</b></p>	<p>Configure the port to send LLDP-MED Inventory Management TLVs. The no command disables the capability.</p>
<p><b>network policy {voice   voice-signaling   guest-voice   guest-voice-signaling   softphone-voice   video-conferencing   streaming-video   video-signaling} [status {enable   disable}] [tag {tagged   untagged}] [vid {&lt;vlan-id&gt;   dot1p}] [cos &lt;cos-value&gt;] [dscp &lt;dscp-value&gt; ]</b> <b>no network policy {voice   voice-signaling   guest-voice   guest-voice-signaling   softphone-voice   video-conferencing   streaming- video   video-signaling}</b></p>	<p>Configure network policy of the port, including VLAN ID, the supported application (such as voice and video), the application priority and the used policy, and so on.</p>
<p><b>civic location {dhcp server   switch   endpointDev} &lt;country-code&gt;</b> <b>no civic location</b></p>	<p>Configure device type and country code of the location with Civic Address LCI format and enter Civic Address LCI address mode. The no command cancels all configurations of the location with Civic Address LCI format.</p>
<p><b>ecs location &lt;tel-number&gt;</b> <b>no ecs location</b></p>	<p>Configure the location with ECS ELIN format on the port, the no command cancels the configured location.</p>

<b>lldp med trap {enable   disable}</b>	Enable or disable LLDP-MED trap for the specified port.
Civic Address LCI address mode	
<b>{description-language   province-state   city   county   street   locationNum   location   floor   room   postal   otherInfo} &lt;address&gt;</b> <b>no {description-language   province-state   city   county   street   locationNum   location   floor   room   postal   otherInfo}</b>	Configure the detailed address after enter Civic Address LCI address mode of the port.
Global mode	
<b>lldp med fast count &lt;value&gt;</b> <b>no lldp med fast count</b>	When the fast LLDP-MED startup mechanism is enabled, it needs to fast send the LLDP packets with LLDP-MED TLV, this command is used to set the value of the fast sending packets, the no command restores the default value.
Admin mode	
<b>show lldp</b>	Show the configuration of the global LLDP and LLDP-MED.
<b>show lldp [interface ethernet &lt;IFNAME&gt;]</b>	Show the configuration of LLDP and LLDP-MED on the current port.
<b>show lldp neighbors [interface ethernet &lt;IFNAME&gt;]</b>	Show LLDP and LLDP-MED configuration of the neighbors.
<b>show lldp traffic</b>	Show the statistics of the sent and received packets of port LLDP and LLDP-MED.

## 11.3 LLDP-MED Example

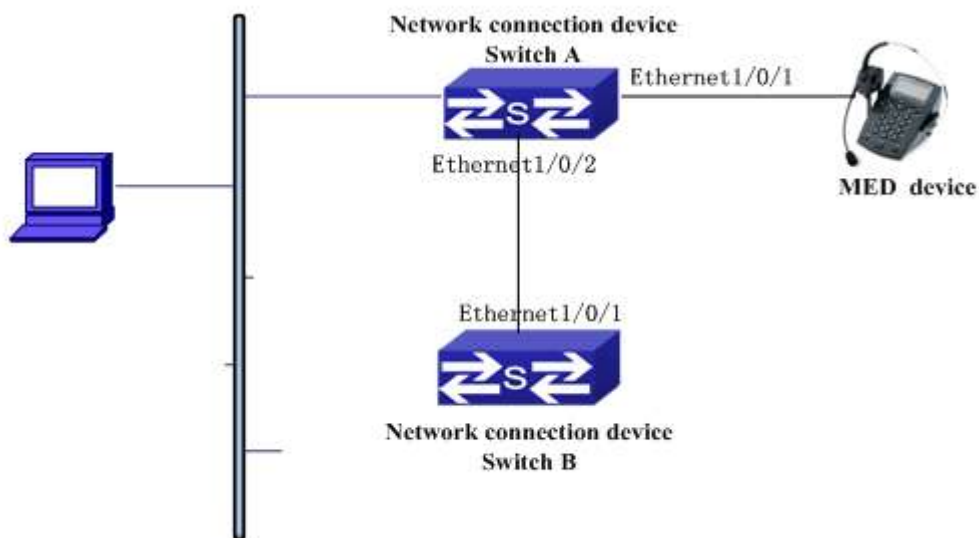

Fig 11-1 Basic LLDP-MED configuration topology

### 1) Configure Switch A

```
SwitchA(config)#interface ethernet1/0/1
```

```
SwitchA (Config-If-Ethernet1/0/1)# lldp enable
```

```
SwitchA (Config-If-Ethernet1/0/1)# lldp mode both ( this configuration can be omitted, the
default mode is RxTx )
```

```
SwitchA (Config-If-Ethernet1/0/1)# lldp transmit med tlv capability
```

```
SwitchA (Config-If-Ethernet1/0/1)# lldp transmit med tlv network policy
```

```
SwitchA (Config-If-Ethernet1/0/1)# lldp transmit med tlv inventory
```

```
SwitchB (Config-If-Ethernet1/0/1)# network policy voice tag tagged vid 10 cos 5 dscp 15
```

```
SwitchA (Config-If-Ethernet1/0/1)# exit
```

```
SwitchA (config)#interface ethernet1/0/2
```

```
SwitchA (Config-If-Ethernet1/0/2)# lldp enable
```

```
SwitchA (Config-If-Ethernet1/0/2)# lldp mode both
```

### 2) Configure Switch B

```
SwitchB (config)#interface ethernet1/0/1
```

```
SwitchB(Config-If-Ethernet1/0/1)# lldp enable
```

```
SwitchB (Config-If-Ethernet1/0/1)# lldp mode both
```

```
SwitchB (Config-If-Ethernet1/0/1)# lldp transmit med tlv capability
```

```
SwitchB (Config-If-Ethernet1/0/1)# lldp transmit med tlv network policy
```

```
SwitchB (Config-If-Ethernet1/0/1)# lldp transmit med tlv inventory
SwitchB (Config-If-Ethernet1/0/1)# network policy voice tag tagged vid 10 cos 4
3) Verify the configuration
# Show the global status and interface status on Switch A.
SwitchA# show lldp neighbors interface ethernet 1/0/1
Port name : Ethernet1/0/1
Port Remote Counter : 1
TimeMark :20
ChassisIdSubtype :4
ChassisId :00-03-0f-00-00-02
PortIdSubtype :Local
PortId :1
PortDesc :****
SysName :****
SysDesc :*****

SysCapSupported :4
SysCapEnabled :4

LLDP MED Information :
MED Codes:
(CAP)Capabilities, (NP) Network Policy
(LI) Location Identification, (PSE)Power Source Entity
(PD) Power Device, (IN) Inventory
MED Capabilities:CAP,NP,PD,IN
MED Device Type: Endpoint Class III
Media Policy Type :Voice
Media Policy :Tagged
Media Policy Vlan id :10
Media Policy Priority :3
Media Policy Dscp :5
Power Type : PD
Power Source :Primary power source
Power Priority :low
Power Value :15.4 (Watts)
Hardware Revision:
Firmware Revision:4.0.1
Software Revision:6.2.30.0
```

```
Serial Number:
Manufacturer Name:****
Model Name:Unknown
Assert ID:Unknown
IEEE 802.3 Information :
  auto-negotiation support: Supported
  auto-negotiation support: Not Enabled
  PMD auto-negotiation advertised capability: 1
  operational MAU type: 1
SwitchA# show lldp neighbors interface ethernet 1/0/2
Port name : interface ethernet 1/0/2
Port Remote Counter: 1

Neighbor Index: 1
Port name : Ethernet1/0/2
Port Remote Counter : 1
TimeMark :20
ChassisIdSubtype :4
ChassisId :00-03-0f-00-00-02
PortIdSubtype :Local
PortId :1
PortDesc :Ethernet1/0/1
SysName :****
SysDesc :*****

SysCapSupported :4
SysCapEnabled :4
```

Explanation:

- 1) Both Ethernet2 of switch A and Ethernet1 of switch B are the ports of network connection device, they will not send LLDP packets with MED TLV information forwardly. Although configure Ethernet1 of switch B to send MED TLV information, it will not send the related MED information, that results the corresponding Remote table without the related MDE information on Ethernet2 of switch A.
- 2) LLDP-MED device is able to send LLDP packets with MED TLV forwardly, so the corresponding Remote table with LLDP MED information on Ethernet1 of switch A.



## 11.4 LLDP-MED Troubleshooting

If problems occur when configuring LLDP-MED, please check whether the problem is caused by the following reasons:

- ☞ Check whether the global LLDP is enabled.
- ☞ Only network connection device received LLDP packets with LLDP-MED TLV from the near MED device, it sends LLDP-MED TLV. If network connection device configured the command for sending LLDP-MED TLV, the packets also without LLDP-MED TLV sent by the port, that means no MED information is received and the port does not enable the function for sending LLDP-MED information.
- ☞ If neighbor device has sent LLDP-MED information to network connection device, but there is no LLDP-MED information by checking **show lldp neighbors** command, that means LLDP-MED information sent by neighbor is error.

# Chapter 12 bpdu-tunnel-protocol Configuration

## 12.1 Introduction to bpdu-tunnel-protocol

BPDU Tunnel is a Layer 2 tunnel technology. It allows Layer 2 protocol packets of geographically dispersed private network users to be transparently transmitted over specific tunnels across a service provider network.

### 12.1.1 bpdu-tunnel-protocol function

In MAN application, multi-branches of a corporation may connect with each other by the service provider network. VPN provided by the service provider enables the geographically dispersed networks to form a local LAN, so the service provider needs to provide the tunnel function, namely, data information generated by user's network is able to inextenso arrive at other networks of the same corporation through the service provider network. To maintain a local concept, it not only needs to transmit the data within the user's private network across the tunnel, but also transmit layer 2 protocol packets within the user's private network.

### 12.1.2 Background of bpdu-tunnel-protocol

Special lines are used in a service provider network to build user-specific Layer 2 networks. As a result, a user network is broken down into parts located at different sides of the service provider network. As shown in Figure, User A has two devices (CE 1 and CE 2) and both devices belong to the same VLAN. User's network is divided into network 1 and network 2, which are connected by the service provider network. When Layer 2 protocol packets cannot implement the passthrough across the service provider network, the user's network cannot process independent Layer 2 protocol calculation (for example, spanning tree calculation), so they affect each other.

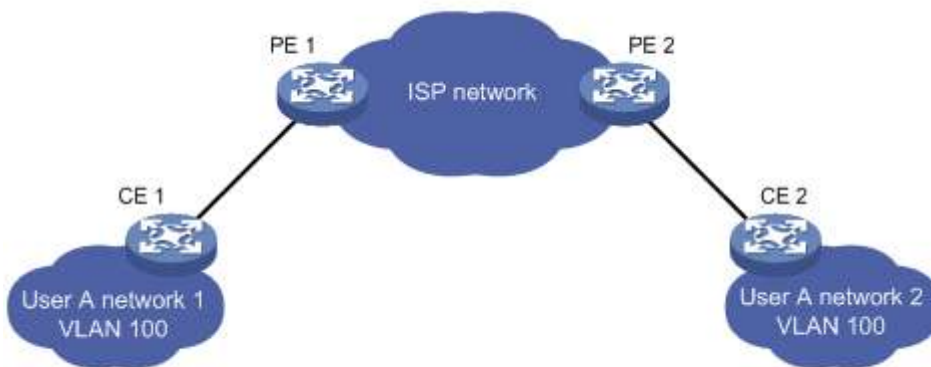

Fig 12-1 BPDU Tunnel application

## 12.2 bpdu-tunnel-protocol Configuration Task List

bpdu-tunnel-protocol configuration task list:

1. Configure tunnel MAC address globally
2. Configure the port to support the tunnel

### 1. Configure tunnel MAC address globally

Command	Explanation
Global mode	

<pre> <b>bpdu-tunnel-protocol {stp  gvrp  dot1x} {group-mac &lt;mac&gt;   default-group-mac}</b>  <b>bpdu-tunnel-protocol user-defined-protocol &lt;name&gt; protocol-mac &lt;mac&gt; {group-mac &lt;mac&gt;   default-group-mac}</b>  <b>bpdu-tunnel-protocol user-defined-protocol &lt;name&gt; protocol-mac &lt;mac&gt; escape-type ethernetii protocol-type &lt;type&gt; {group-mac &lt;mac&gt;   default-group-mac}</b>  <b>bpdu-tunnel-protocol user-defined-protocol &lt;name&gt; protocol-mac &lt;mac&gt; escape-type snap {oui &lt;oui&gt;  } protocol-type &lt;type&gt; {group-mac &lt;mac&gt;   default-group-mac}</b>  <b>bpdu-tunnel-protocol user-defined-protocol &lt;name&gt; protocol-mac &lt;mac&gt; escape-type llc dsap &lt;dsap&gt; ssap &lt;ssap&gt; {group-mac &lt;mac&gt;   default-group-mac}</b>  <b>no                bpdu-tunnel-protocol user-defined-protocol &lt;name&gt;</b> </pre>	<p>Configure or cancel the tunnel MAC address globally.</p>
---	---

**2. Configure the port to support the tunnel**

Command	Explanation
Port mode	
<pre> <b>bpdu-tunnel-protocol {stp  gvrp  dot1x} user-defined-protocol &lt;name&gt;}</b> <b>no bpdu-tunnel-protocol {stp  gvrp  dot1x} user-defined-protocol &lt;name&gt;}</b> </pre>	<p>Enable the port to support the tunnel, the no command disables the function.</p>

**12.3 Examples of bpdu-tunnel-protocol**

Special lines are used in a service provider network to build user-specific Layer 2

networks. As a result, a user network is broken down into parts located at different sides of the service provider network. As shown in Figure, User A has two devices (CE 1 and CE 2) and both devices belong to the same VLAN. User's network is divided into network 1 and network 2, which are connected by the service provider network. When Layer 2 protocol packets cannot implement the passthrough across the service provider network, the user's network cannot process independent Layer 2 protocol calculation (for example, spanning tree calculation), so they affect each other.

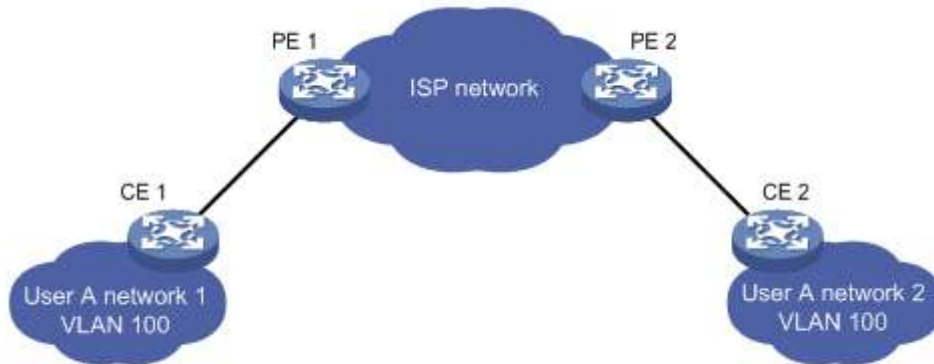

Fig 12-2 BPDU Tunnel application environment

With BPDU Tunnel, Layer 2 protocol packets from user's networks can be passed through over the service provider network in the following work flow:

1. After receiving a Layer 2 protocol packet from network 1 of user A, PE 1 in the service provider network encapsulates the packet, replaces its destination MAC address with a specific multicast MAC address, and then forwards the packet in the service provider network.
2. The encapsulated Layer 2 protocol packet (called BPDU Tunnel packet) is forwarded to PE 2 at the other end of the service provider network, which de-encapsulates the packet, restores the original destination MAC address of the packet, and then sends the packet to network 2 of user A.

bpdu-tunnel configuration of edge switches PE1 and PE2 in users side port in the following:

PE1 configuration:

```
PE1(config)# bpdu-tunnel-protocol stp default-group-mac
```

```
PE1(config-if-ethernet1/0/1)# bpdu-tunnel-protocol stp
```

PE2 configuration:

```
PE2(config)# bpdu-tunnel-protocol stp default-group-mac
```

```
PE2(config-if-ethernet1/0/1)# bpdu-tunnel-protocol stp
```

## 12.4 bpdu-tunnel-protocol Troubleshooting

After port disables stp, gvrp and dot1x functions, it is able to configure bpdu-tunnel-protocol function.

# Chapter 13 EEE Energy-saving Configuration

## 13.1 Introduction to EEE Energy-saving

eee is Energy Efficient Ethernet. After the port is enabled this function, switch will detect the port state automatically. If the port is free and there is no data transmission, this port will change to the power saving mode and it will cut down the power of the port to save the energy.

## 13.2 EEE Energy-saving configuration List

### 1. Enable EEE energy-saving function

Command	Explanation
Port Mode	
<b>eee enable</b> <b>no eee enable</b>	Enable the energy-saving function of the port; the no command disables the energy-saving function of the port.

## 13.3 EEE Energy-saving Typical Examples

**Case:** Configure the port 1 of switch as saving mode.

Below is the configuration steps:

```
Switch(config-if-ethernet1/0/1)# eee enable
```

# Chapter 14 LED shut-off Configuration

## 14.1 Introduction to LED shut-off

The LED shut-off function of the port can make all the LEDs off according to the configured time-range by user no matter what the link-act status is. It can save power. When there is no configured time-range, or the range is exceeded, the port LED can be on according to the link-act status.

## 14.2 LED shut-off Configuration

### 1. Make the LED off in the appointed time-range

Command	Explanation
Global Configuration Mode	
<b>port-led shutoff time-range &lt;time-range-name&gt;</b> <b>no port-led shutoff</b>	Configure of cancel the LEDs to be off in the appointed time-range.

## 14.3 LED shut-off Examples

**Case:** Configure all the LEDs to be off from Monday 14:30 to Friday 18:30.

The configuration steps are as below:

1. Configure a time-range:

```
switch(config)#:time-range t1
```

2. Appoint the time-range for t1:

```
switch(Config-Time-t1)#periodic Monday Friday 14:30:00 to 18:30:00
```

3. Configure the time-range of the LED OFF globally:

```
switch(config)#: port-led shutoff time-range t1
```