

User's Manual

Professional Digital Satellite CI Decoder

DCH-3000P

DCH-2000P

DCH-1000P

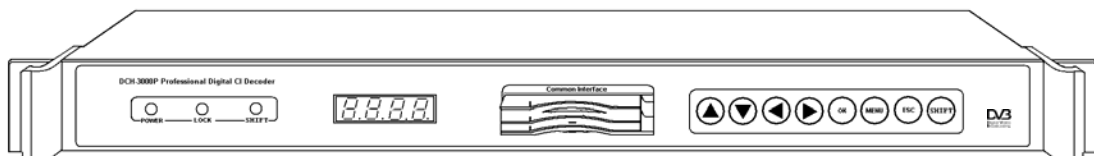







Content Table

1. Overview	2
1.1 Main Features	2
1.2 For Your Safety	2
1.3 Unpacking	2
2. Specification (Comply with DVB-S , ETSI 300421 standard)	3
3. Installation and Usage	4
3.1 Front panel	4
3.2 Rear panel	6
3.3 Installation	6
4. General Functions	8
4.1 Select Channel	8
4.2 Channel Information	8
4.3 Volume Controls	8
4.4 Audio Control	8
4.5 TV/Radio switching	8
5. Menu Information	9
5.1 Channel Manager	9
5.2 Channel Setting	10
5.3 Option Menu	13
5.4 Common Interface	15
6. ASI Input / Output and CI Descramble Function	16
6.1 ASI output and descramble / scramble setting	16
6.2 CI Multi-channel Descramble	16
6.3.ASI Input function	17
7. Trouble Shooting	17

Caution Statements:

Please observe the following safety requirements before operating the equipment.

 Electrical Shock	 Avoid Moisture
<p>Thoroughly check your electrical grounding and connectors prior to powering. Make sure all connectors are of the three-prong type to ensure proper grounding.</p> <p>Whenever the equipment is not used for a prolong period of time, you should disconnect the power cord.</p>	<p>Do not use this equipment in high moisture environment.</p>
 Power Disconnect	 No Heavy Stacking
<p>Disconnect the power cord under the following conditions :</p> <ol style="list-style-type: none">1.damage on cord and connector2.equipment get wet or substantial moisture enter the chassis3.exposure to rain or water4. equipment dropped or damaged5.apparent irregularity appears	<p>Do not stack the equipment back to back to allow proper ventilation.</p>
 Do Not Open The Equipment	 No Touching with Bare Hands
<ol style="list-style-type: none">1. Do not try to repair by yourself2. Do not use unauthorized part for repair3. Do not open the covers of the equipment without proper factory authorization	<p>Do not touch the equipment during heavy lightening condition.</p>
	 Caution
	<ol style="list-style-type: none">1.Do not place this equipment on unstable support.2.Do not place objects on top of the equipment to block up the ventilation opening.3.Do not place radio active instrument or object on top of adjacent to the equipment.4.Provide proper room ventilation during operation of this equipment.5.Verify with the repair engineer or authorized entity after repair is done to be sure the equipment can be put back to operation.6.Read the operating manual prior to usage.

1. Overview

DCH-1000P/DCH-2000P/DCH-3000P is professional digital satellite receiver with CI interface, DCH-1000P could output decoded TV image; DCH-2000P could output decoded TV image and ASI stream; DCH-3000P has the same function with DCH-1000P/2000P, and DCH-3000P has ASI Input interface.

If you have any problem of operation, please refer to the related content of this manual. If the problem still exists, please contact the seller or you can directly contact us.

1.1 Main Features

- Fully comply with DVB-S and MPEG-2 standards
- Common Interface with 2 slots (PCMCIA) that can support the encrypted systems of Conax, Irdeto, NDS, Viaccess and so on.
- Support multi-descramble function, it is depends on the CI module (It is only available on DCH-2000P/ DCH-3000P)
- 2 slots of PCMCIA Module could descramble multi program and stream (It is only available on DCH-2000P/ DCH-3000P)
- Support professional Audio/Video interface output and ASI output (It is only available on DCH-2000P/ DCH-3000P)
- Support ASI input, the un-decrypted programs could loop through to another DCH-3000P for further decrypting (It is only available on DCH-3000P)
- User-friendly OSD and easy-to-use menu system
- User programmable various satellite & transponder information
- Automatic network search for newly added channels/programs
- Stores up to 2000 channels
- SCPC/MCPC receivable from C/Ku band satellite
- VBI Teletext support
- Antenna positioning help feature
- Automatic PAL/NTSC conversion
- Automatic last channel saving

1.2 For Your Safety

- Allow clear space around the IRD for sufficient ventilation
- Use a soft cloth and a mild solution of washing liquid to clean the casing
- Do not connect or modify cables when the is IRD plugged in
- Do not remove the cover
- Do not allow the unit to be exposed to extreme heat, cold or humid conditions
- Never allow liquids, spray or other materials to come into contact with the inside of the model.

1.3 Unpacking

Please unpack the box to check all of the following items are included in the packaging:

- User's manual 1pcs
- DCH-1000P/2000P/3000P 1pcs
- Power cord with three pins 1pcs
- AV cable 1pcs
- ASI cable 1pcs (It is only available on DCH-2000P/3000P)
- XLR connector 2pcs (It is only available on DCH-3000P)

2. Specification (Comply with DVB-S , ETSI 300421 standard)

QPSK demodulation & FEC parameters

Input Frequency Range:	Ku & C-band 950MHz ~ 2150MHz
Input Level	-65dBm ~ -25dBm
Input Impedance	75 Ω
Input Connector	F-type
Symbol Rate	2MB~45MB (SPTS or MPTS)
FEC	1/2, 2/3, 3/4, 5/6, 6/7,7/8
Reeds Salomon Decoding	204, 188, T = 8

LNB Control

Polarization Voltage	13V / 18V
High/Low band control	0/22K Switch

Front panel

Common Interface	PCMCIA Module slot, fully support Irdeto, Viaccess, NDS CAS and so on
LED Display	Display current receiving channel number
8 touch button to control	UP、DOWN、LEFT、RIGHT、OK、MENU、ESC、SHIFT
Indicator light Display	1 Power Indicator、1 Satellite Signal Locking (LOCK) and 1 Remote Control (REMOTE)

ASI Input / Output

Interface	75 Ω , BNC connector
Data Transmission Rate	270Mb/s
Data Mode	Byte
Packet Length	204
Signal Level	1 Vpp \pm 0.1V

Others

Power supply	AC 90V~260V 50Hz/60Hz
Net weight	5Kg

Dimension	44mm×255mm×483mm
Operation Temperature	0-40℃
Storage Temperature	-20~70℃

3. Installation and Usage

3.1 Front panel

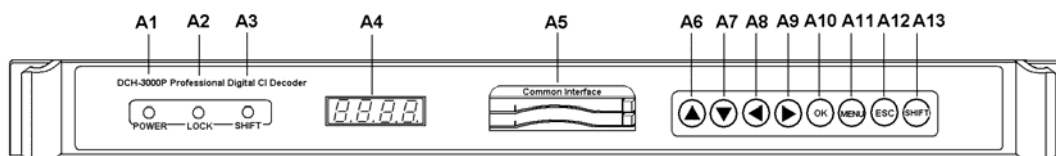

A1	POWER	Power indicator, it is on when the power supply is work
A2	LOCK	Satellite signal indicator, it is on when the satellite signal or ASI signal is locked
A3	SHIFT	Shift indicator, when it is on, the keys of A6~A9 is of the second function.
A4	LED	Display current channel No. and information, when IRD is start, it display as boot & ---- In general, the LED is displayed the Channel number from 0 ~ 2000, when you are tuning the volume it will display from 0 ~ 17, if you are checking the channel information, the LED will display the BER value from 0.00 – 10.00
A5	Common Interface	2 PCMCIA Module slot
A6~A9	▲▼◀▶	These keys are used to set or select the parameters of functions, it will be defined with different functions in different work mode, please refer to below table for detail definition of A6~A9,:

Key	Viewing mode		Menu mode
	SHIFT is off	SHIFT is on	
▲/Up	Change to last channel	Select audio language	Move up cursor
▼/Down	Change to next channel	Select audio channel	Move down cursor
◀/Left	Decrease volume	Display channel information	Modify parameter/ Move left cursor
▶/Right	Increase volume	TV/Radio switch	Modify parameter/ Move right cursor

A10	OK	Confirmation Key, it is used to enter submenu or confirm the operation.
A11	MENU	Menu key, it is used to display menu and command box
A12	ESC	Exit key, it is used to return to last menu or exit menu.
A13	SHIFT	Second function key, press the SHIFT key for 2 seconds, SHIIFT will be on, then A6~A9 will be on second function mode, please refer to A6~A9 for detail. When SHIFT is on, the IRD can be operated by the remote controller. Please be attention to that the remote controller is optional.

3.2 Rear panel

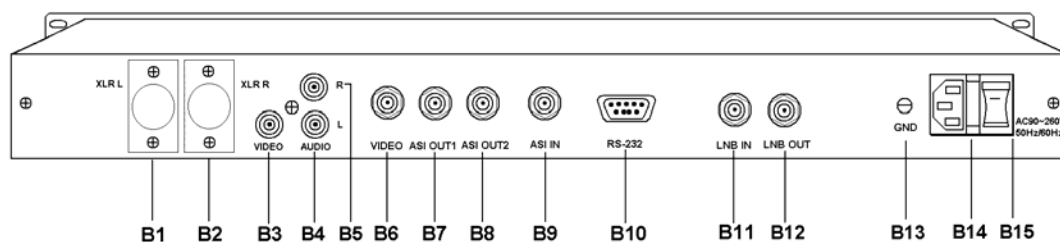

B1	XLR L	XLR interface, left audio channel balance output
B2	XLR R	XLR interface, right audio channel balance output
B3	VIDEO	RCA interface, AV video output
B4	AUDIO L	RCA interface, left audio channel output
B5	AUDIO R	RCA interface, right audio channel output
B6	VIDEO	BNC interface, multiplex video output
B7	ASI OUT1	ASI output interface
B8	ASI OUT2	ASI output interface
B9	ASI IN	ASI input interface
B10	RS-232	data interface, it is used to upgrade software
B11	LNB IN	Satellite signal input interface
B12	LNB OUT	Satellite signal output interface, it provide satellite signal to next IRD.
B13	GND	Connect to ground
B14	FUSE	Fuse, it is installed in power socket
B15	AC90~260V 50Hz/60Hz	AC power socket

3.3 Installation

DCH-3000P/2000P/1000P is installed on the 19" rack, please refer to the user's manual when you install DCH-3000P/2000P/1000P.

The following is the typical applications of DCH-3000P/2000P/1000P.

3.3.1 Used as signal resource of Multiplexer

The DCH-3000P receives the QPSK signal, then demodulates it and output ASI baseband transport stream to a DVB MPEG-2 multiplexer. The Multiplexer filters or refreshes the PIDs of the selected programs, and rebuild the PSI, NIT and other necessary tables.

3.3.2 The DCH-3000P receives the QPSK satellite signal and demodulate the signal, it will output ASI Baseband Transport Stream to QAM modulator, the QAM modulator will send the QAM signal to CATV network.

3.3.3 The DCH-3000P receives the QPSK satellite signal and demodulate the signal, it will output ASI Baseband Transport Stream to a DVB-IP gateway to work as a source for internet.

The DCH-3000P could provide Baseband Transport Stream to monitor and analyse the satellite signal.

a) Connect to Multiplexer

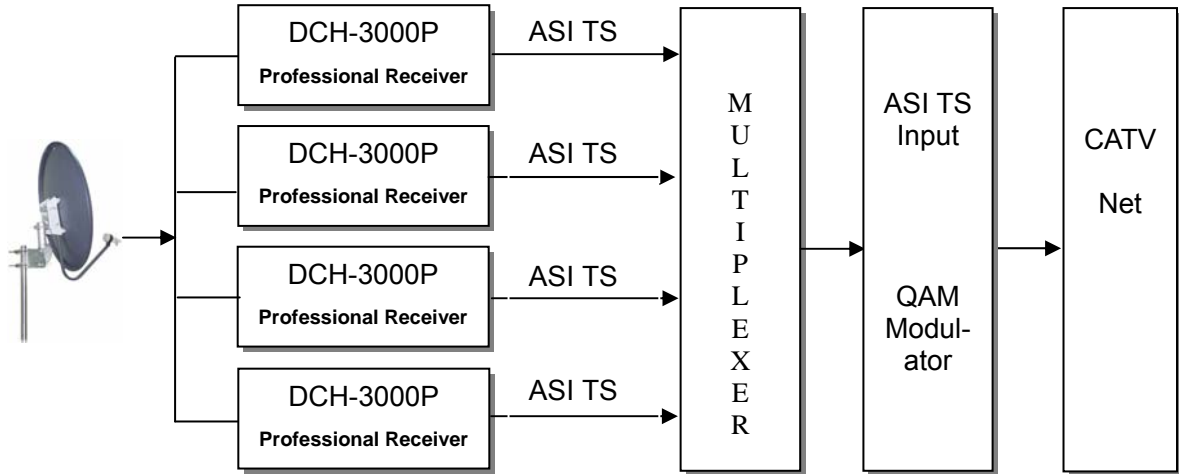

b) Connect to QAM Modulator

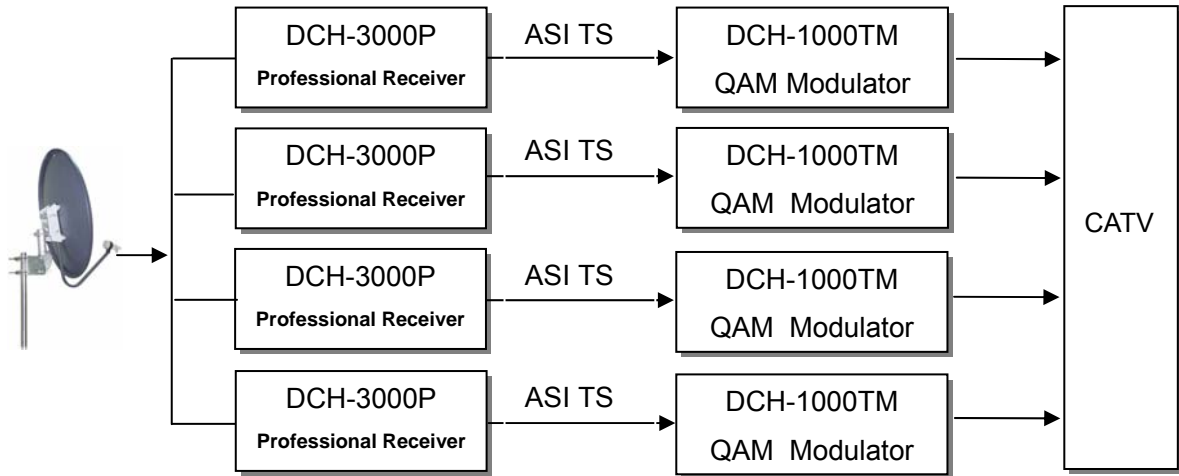

c) Connect to DVB-IP gateway

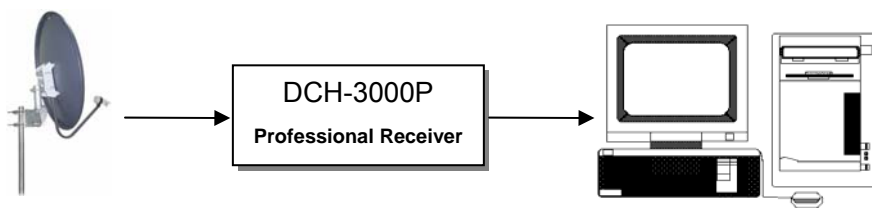

4. General Functions

The following describes the basic function of your DCH-1000P/2000P/3000P while watching digital TV broadcasts.

4.1 Select Channel

To select channels, use the CH+/CH- or numeric keys on the RCU.

In addition to the above normal function, the DCH-1000P/2000P/3000P provides a more convenient channel change function.

While watching, press OK key on the RCU. A channel list defined as ALL TV or ALL RADIO will be displayed on the right side of the screen. If you press ESC key, the list will disappear.

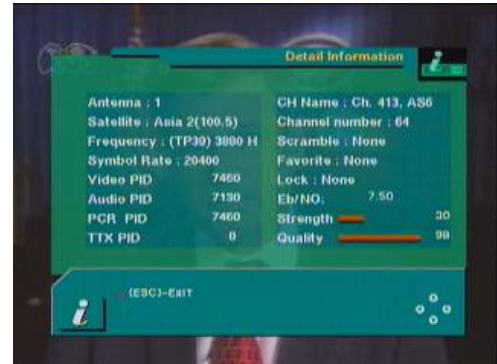

4.2 Channel Information

Every time you change channels, you will receive short-form program information for approximately 6 seconds.

If you want to check detail channel information, you could press ◀ key while watching or while Shift indicator (Yellow) is on. If you press ESC key, the information will disappear.



4.3 Volume Controls

While SHIFT indicator is off and watching, you could press ◀▶ key of front panel to control volume.

Notify: The IRD have 18 volume grades, while tuning volume, the LED of front panel will display value of volume from 0 to 17.



4.4 Audio Control

While SHIFT indicator is off and watching, press ▲ key to switch audio language, press ▼ key to switch audio channel, you will receive short-form audio information for approximately 6 seconds.

4.5 TV/Radio switching

While SHIFT indicator is on and watching, press ▶ key to switch TV mode and Broadcasting mode.

Notify: Pressing ▶ key for 2 minutes, the SHIFT indicator will "ON" or "OFF".



5. Menu Information

Apply or switch ON power once you have installed and connected the cables to the DCH-1000P/2000P/3000P and other equipments. If it is first operation, the main menu will directly display after power on, otherwise, it will play the last watching channel after it power on, then press MENU key of RCU to entry the main menu.

This Main Page menu consists of 5 primary menu items:

- Channel Manager: Edit or delete programs
- Installation: Set antenna parameters and searching channel, or resume factory default configuration.
- Option Menu: Setting system parameters and antenna position, viewing the receiving information.
- Common Interface: Checking status of common interface and setting disscrambler mode.

Note:

- The ◀▶ keys let you move from left to right to any item within the menu, the ▲▼ keys let you move from up to down to any item within the menu, pressing OK key to confirm and pressing ESC key to exit.
- For the items with ◀▶ mark, the ◀▶ keys let you modify the parameters, or press OK key to display the list, then select the correct parameters in the list.
- For the items with ■■■ mark, use the ▶ key to display the numeric keypad, then press the ▲▼ keys to move to numbers, use the ◀▶ keys to select the correct number, and press OK to make it available, use ▲▼ keys to select “OK” to make final confirmation of modified parameters, or to select “Cancel” to cancel the input data.

5.1 Channel Manager

The Channel Manager is consist of the below two items,

- TV Channel
- Radio Channel

Since the functions related to the Radio Channel is the same as that for TV Channel, this manual will only detail the TV Channel manager.

Select TV Channel from the Main Page and press OK, the TV Channel Manager is displayed. On the left side of the TV Channel menu, you can see the channel list, on the right side, you can view the current channel in the Picture in Graphic(PIG) mode (1/9 size of the normal screen size.) You could also see channel information under the PIG screen.



When you move the CH+/CH- cursor from one channel to another, the PIG will change accordingly.

In the TV Channel Manager, you can delete TV channels by using Delete Channel command.

First select the TV channel which you want to delete using the ▲▼ keys. Press OK.

An “X” marks the channel which will be deleted. Repeat this procedure for as many TV Channels as want. (To de-select any marked TV channel select it and press OK, the “X” will be removed).

If you decide to delete the marked channels, press ESC. A message “ Are you sure to delete marked channels” is displayed. Select “OK” or “Cancel” in the message box and then press the OK key to make sure your operation.

Press ESC to exit the Main Menu, a message is displayed “ Saving data...”.

After data being saved, you could view the channel list to check if the delete operation is success.



Note:

- The deleted channel cannot be recovered unless you start a Channel Search again.
- Please do not power off when the message “Saving data...” is displayed, in case any information missed or other trouble.

5.2 Installation

5.2.1 Antenna Setting

1. Antenna: each antenna is correspondent to a satellite.
2. Satellite: Select the satellite you want.
3. LNB Type: Select your LNB type, there are three options, if you have universal LNB, select Univ.

- General: Single Polarization LNBF
- Univ: Dual-pol. (Universal) LNB.
- LNBF: Dual-pol. C-band LNB



4. LNB Freq. : when LNB type changed, the frequency of LNB is changed accordingly. You could input frequency using numeric keys. DCH-3000P supports two LNB local frequency, if the channel couldn't be searched with first local frequency, it will automatic search the channel with second local frequency.

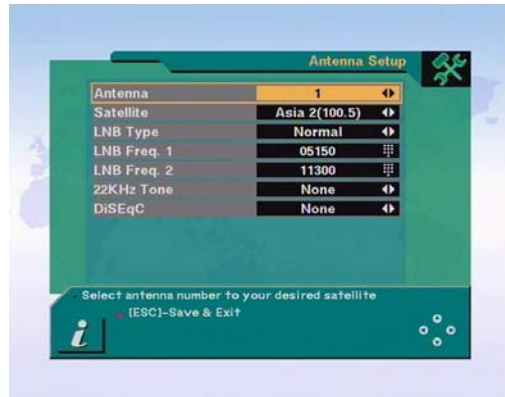

5. Switches (22KHz, DiSEqC) : you could select the switches with which you want to configure the antenna.

Press ESC to finish antenna setting, the message “ Are you sure to change the configuration of Antenna set up?” will be displayed. Select OK and press OK key to confirm it, then wait for the update data to be saved.

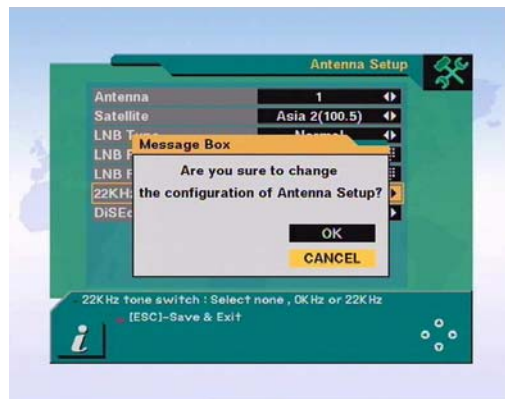

5.2.2 Channel Search

1. Antenna : Select the serial number of the satellite you want.

Notify: On the right side of screen, you could see the correspondent parameters of selected satellite, if it is not correct, you could modify it in Antenna Setting.

2. Transponder: Use ◀▶ keys to select the desired TP, or move to the new TP item, you could edit the parameters of this TP.

3. Frequency & Symbol Rate: Edit the frequency and symbol rate. If the pre-setting program couldn't meet your requirement, you could set the satellite parameters by manual.

4. Polarization: Select H or V.

5. Channel Search : After setting the satellite parameters, you could press ◀▶ keys to select serach options,

- Search SAT: Search all pre-setting channels for selected satellite.



- Search TP: Search all channels for one TP, which has been selected from the TP column.
- Search Network: Search channels for the network related to the TP. You could use it to search new satellite channel.

How to search: After setting parameters, move cursor to search column, choose desired search option, then press OK to begin searching.

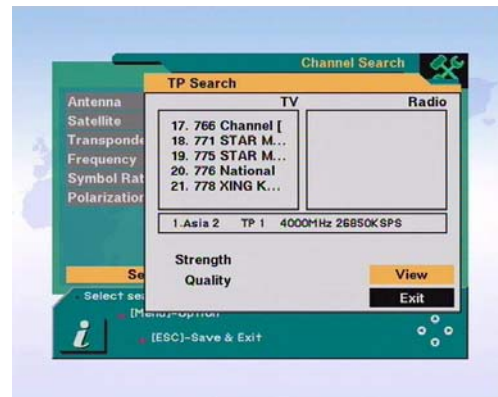

During searching procedure you can see a list of the previously searched channels in the Searched List Box on the screen.

On completion of searching channels, you could move cursor to select "VIEW" or "EXIT".

6. In Channel Search, press Menu key, the submenu will be displayed,

- Delete TP
- Search Options
- Setting PID

(1) Delete TP: Move to the Transponder which you want to delete, press Menu Key to display the Command Box, then select "Delete TP" Command, the message " Are you sure to delete this TP?" will be displayed, select "OK" and press OK key to confirm it.

(2) Search Options: it provide you convenient options to search channels, you could only serach FTA channels or All channels.

(3) Set PID: You could set PID (Packet Identifier) by manual with "Set PID" command.

Press Menu to dispay the Command box, select "Set PID" command and press OK, the menu "Set PID" will be displayed, you could input correct data and press OK key to confirm it.

If the Set PID operation is success, you could see a new program which be named "PID- XXXX" in the channel list, the "XXXX" means Video PID.

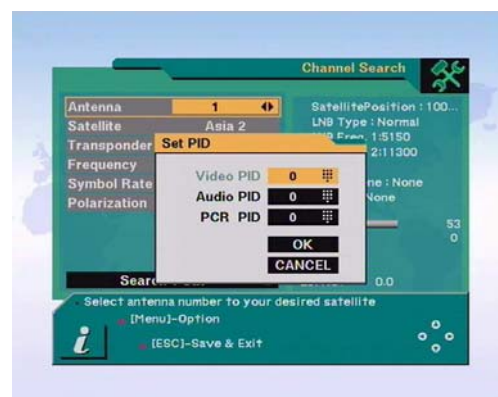

5.2.3 Factory Default

If you want to bring DCH-3000P back to the factory default configuration, select “Factory Default” and press OK key.

The warning message will be displayed. If you are sure your operation, select OK and press OK key. Notify: Once back to factory default condition, you will lose all of data and information which was previously installed.



5.3 Option Menu

The Option Menu consists of 3 submenus

- System Setting
- Antenna Direction Help
- Receiver Information



5.3.1 System Setting

1. OSD : You could select the OSD language between “Chinese” or “English”
2. Audio Language : Set the priority of audio language, you could set the desired language to be first priority under the condition that this language is supported by the channel.
3. LNB power: If DCH-1000P/2000P/3000P is connected to the LNB, select “YES”. But if it is connected to another Receiver through Loop Through support, you should check which receiver is connected directly to the LNB. In case the other Receiver is directly connected to the LNB, then select “OFF”.
4. TV Type: Select the type according to your TV system, PAL/NTSC/PAL&NTSC.
5. Start On Channel: Press OK , the message “ Activate Start On Channel?” will be displayed, select “OK” and press OK key, the channel list will be displayed, you could select one channel from it, the selected channel starts whenever you turn on the Receiver. If you haven’t set Start On Channel, it will be automatic play the last viewing channel.



* The following function is only available for DCH-3000P:

6. Signal Source: Select the signal source between TUNER or ASI.
7. ASI In: Input clear transport stream or scrambled transport stream.
8. ASI Packet: Setting ASI stream data packet format between “188” or “Bypass” (for “Bypass” function: the receiver will transfer the original data package format.)

5.3.2 Antenna Direction Help

DCH-1000P/2000P/3000P provide the antenna direction help function, you could get correct information to direct your antenna toward a satellite.

Steps:

1. First select your desired satellite name, then the location of selected satellite will be displayed. In case the location of the satellite is changed, you can re-set to the new location.
2. Second, input the value of local Longitude and Latitude, move cursor to “Calculate” then press OK, the correct information of satellite will be displayed.



5.3.3 Receiver Information

It will display the software version, hardware version and copyright information about this Receiver.

5.4 Common Interface

DCH-1000P/2000P/3000P have 2 CI slots, you should select the suitable CI module and Smart Card corresponding to the scrambled program.

Note: Please pay attention to the interface direction of the CI Module and Smart Card, it should be inserted to slot with correct direction and it should not be plugged arbitrarily.



5.4.1 Common Interface status

It is used to check the CI Module information.

If the CI Module and Smart Card is inserted to CI slot, the correspondent slot column will display the CI Module name.

Select the slot you want and press OK, the related information will be displayed.

If there isn't any information about Smart Card, it will display "No Card", please insert the smart card again.

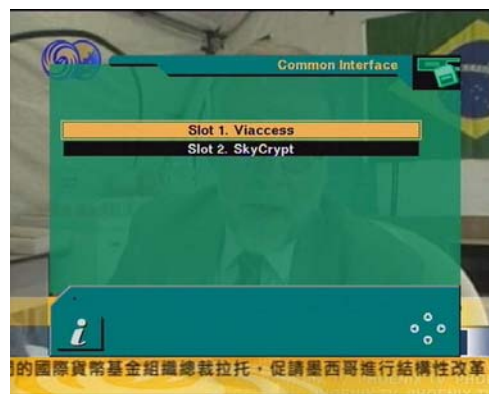

5.4.2 Descrambling Options

Multi-channel descrambling Option depends on the CI module : Only the professional CI Module can support multi-channel descrambling function.

Use this function, you could descramble multiple scrambled programs in a stream with ASI output. 2 or more or all programs in the stream are decrypted.

- Single Channel : it could only decrypt one channel in the multi-program-stream with general CI Module.
- Multiple Channel : it is only available when the professional CI Module supports multi-descrambling function and the Smart Card has multi-program authorization, then 2 or more or all programs in the stream are decrypted.

Note: Please refer to 6.2 ASI multiple channel descrambling.

Slot1 Designation Channel: if the Slot1 hasn't been designated to one channel, the CI Module of Slot1 will descramble the current viewing channel; If it has been designated to one channel, the CI Module of Slot1 will only descramble the designated channel.

Slot2 Designation Channel: it is similar with Slot1 Designation Channel.



6. ASI Input / Output and CI Descramble Function

6.1 ASI output and descramble / scramble setting

This function is only available on DCH-2000P/3000P

- When you are viewing the Free-to-Air satellite program, the ASI stream of this program will be output at the same time, it could be as signal resource when it is connected to QAM Modulator or Multiplexer
- For scrambled programs, you should insert correspondent CI Module and CA Smart Card to descramble this program, then you could view the descrambled programs and the transport stream including the descrambled program could be output at the same time.

You could choose the output stream as descrambled or scrambled. Enter system setting menu, set the ASI output to Descrambled or Scrambled. (Please refer to 5.3.1 system setting)

6.2 CI Multi-channel Descrambling

DCH-1000P/2000P/3000P has 2 methods to descramble multi-channel to output the transport stream with multi-channel descrambled.

Method 1:

1. Insert professional CI Module which supports multi channel descrambling function and CA smart card with multi CA authorization.
2. Enter system setting menu, set the ASI output is “Descramble” (Please refer to 5.3.1 System Setting)
3. Set the descramble option to the item “Multi Channel”, and set the designation channel of Slot1 and Slot2 to “None”. (Please refer to 5.4.2 Descramble option.)
4. Exit Main Menu and back to view mode, press OK key to select the channel which you want to descramble, wait for a while, it will play the selected channel, then select another program which you want to descramble, then the receiver could output the stream of multi descrambled Channels



Note:

1. Because the quantity of multi channels to be descrambled is different by CI Modules, so the quantity of the synchronously-descrambled-channels depends on the CI Module.
2. The Multi Channels must be transmitted from the same Transponder.

Method 2:

1. Slot1 and Slot2 must be all inserted the CI Module and Smart Card.
2. Enter System Setting menu, set the ASI output to “Descramble”. (Please refer to 5.3.1 System Setting)

3. Set the Descramble option to “Single Channel”, and set the designation channel of Slot1 and Slot2 to be the channel which you want to descramble.(Please refer to 5.4.2 Descramble Option).
4. Exit Main Menu and back to View mode, press OK key to select the channel which you want to descramble, and wait for a while, the selected channel will be played, then select another channel which you want to descramble, so it could output the stream with the designated channels which are descrambled.

Note: The Multi Channels must be from the same Transponder.

6.3.ASI Input function

This function is only available on DCH-3000P.

DCH-3000P provide input interface as ASI input port, it could descramble the scrambled ASI stream, and output ASI stream and AV video signal.

- It could directly receive ASI stream from various stream output equipments.
- If you connect in series the ASI OUT and ASI IN interfaces of two or more DCH-3000Ps,the more channels could be descrambled to save remultiplexing resource.

Method: Enter the System Setting menu, set the signal resource to ASI. (Please refer to 5.3.1 System Setting.)

7. Trouble Shooting

Problem	Possible Causes	What To Do
The display of front panel does not light up.	Main cable is not connected	Check the main cable is plugged into the power socket.
No sound or picture / Pause	The antenna is not toward to the satellite.	Adjust the antenna.
	No signal or signal is weak.	Check the cable connection, LNB and the related appliance between LNB and Receiver, or adjust the antenna.
Bad picture/ Pause	The antenna is not toward to the satellite.	Adjust the antenna.
	Signal is too strong	Add a attenuation before LNB IN.
	The antenna size is too small	Change to one big size antenna
	LNB noise factor too high	Change to an LNB with lower Noise factor.
	The LNB is faulty.	Change the LNB.
Couldn't view the scramble channel.	Haven't insert CI Module or the CI Module is not match the scrambled channel.	Insert correct CI Module
	Haven't insert CA Smart Card or the CA Smart Card has not authorization.	Insert correct CA Smart Card

