



Complete Hardware Guide for EX3300 Ethernet Switches



Published: 2012-09-03
Revision 4

Juniper Networks, Inc.
1194 North Mathilda Avenue
Sunnyvale, California 94089
USA
408-745-2000
www.juniper.net

This product includes the Envoy SNMP Engine, developed by Epilogue Technology, an Integrated Systems Company. Copyright © 1986–1997, Epilogue Technology Corporation. All rights reserved. This program and its documentation were developed at private expense, and no part of them is in the public domain.

This product includes memory allocation software developed by Mark Moraes, copyright © 1988, 1989, 1993, University of Toronto.

This product includes FreeBSD software developed by the University of California, Berkeley, and its contributors. All of the documentation and software included in the 4.4BSD and 4.4BSD-Lite Releases is copyrighted by the Regents of the University of California. Copyright © 1979, 1980, 1983, 1986, 1988, 1989, 1991, 1992, 1993, 1994. The Regents of the University of California. All rights reserved.

GateD software copyright © 1995, the Regents of the University. All rights reserved. Gate Daemon was originated and developed through release 3.0 by Cornell University and its collaborators. Gated is based on Kirton's EGP, UC Berkeley's routing daemon (routed), and DCN's HELLO routing protocol. Development of Gated has been supported in part by the National Science Foundation. Portions of the GateD software copyright © 1988, Regents of the University of California. All rights reserved. Portions of the GateD software copyright © 1991, D. L. S. Associates.

This product includes software developed by Maker Communications, Inc., copyright © 1996, 1997, Maker Communications, Inc.

Juniper Networks, Junos, Steel-Belted Radius, NetScreen, and ScreenOS are registered trademarks of Juniper Networks, Inc. in the United States and other countries. The Juniper Networks Logo, the Junos logo, and JunosE are trademarks of Juniper Networks, Inc. All other trademarks, service marks, registered trademarks, or registered service marks are the property of their respective owners.

Juniper Networks assumes no responsibility for any inaccuracies in this document. Juniper Networks reserves the right to change, modify, transfer, or otherwise revise this publication without notice.

Products made or sold by Juniper Networks or components thereof might be covered by one or more of the following patents that are owned by or licensed to Juniper Networks: U.S. Patent Nos. 5,473,599, 5,905,725, 5,909,440, 6,192,051, 6,333,650, 6,359,479, 6,406,312, 6,429,706, 6,459,579, 6,493,347, 6,538,518, 6,538,899, 6,552,918, 6,567,902, 6,578,186, and 6,590,785.

Complete Hardware Guide for EX3300 Ethernet Switches
Copyright © 2012, Juniper Networks, Inc.
All rights reserved.

Revision History
September 2011—Revision 1
November 2011—Revision 2
March 2012—Revision 3
September 2012—Revision 4

The information in this document is current as of the date on the title page.

YEAR 2000 NOTICE

Juniper Networks hardware and software products are Year 2000 compliant. Junos OS has no known time-related limitations through the year 2038. However, the NTP application is known to have some difficulty in the year 2036.

SOFTWARE LICENSE

The terms and conditions for using this software are described in the software license contained in the acknowledgment to your purchase order or, to the extent applicable, to any reseller agreement or end-user purchase agreement executed between you and Juniper Networks. By using this software, you indicate that you understand and agree to be bound by those terms and conditions.

Generally speaking, the software license restricts the manner in which you are permitted to use the software and may contain prohibitions against certain uses. The software license may state conditions under which the license is automatically terminated. You should consult the license for further details.

For complete product documentation, please see the Juniper Networks Web site at www.juniper.net/techpubs.

END USER LICENSE AGREEMENT

The Juniper Networks product that is the subject of this technical documentation consists of (or is intended for use with) Juniper Networks software. Use of such software is subject to the terms and conditions of the End User License Agreement (“EULA”) posted at <http://www.juniper.net/support/eula.html>. By downloading, installing or using such software, you agree to the terms and conditions of that EULA.

Table of Contents

	About This Topic Collection	xiii
	How to Use This Guide	xiii
	List of EX Series Guides for Junos OS Release 12.2	xiii
	Downloading Software	xvi
	Documentation Symbols Key	xvi
	Documentation Feedback	xviii
	Requesting Technical Support	xviii
	Self-Help Online Tools and Resources	xviii
	Opening a Case with JTAC	xix
Part 1	Switch and Components Overview and Specifications	
Chapter 1	EX3300 Switch Overview	3
	EX3300 Switches Hardware Overview	3
	EX3300 Switches First View	3
	Uplink Ports	4
	Power over Ethernet Plus Ports	4
	EX3300 Switch Models	4
	Chassis Physical Specifications for EX3300 Switches	5
	Front Panel of an EX3300 Switch	6
	Rear Panel of an EX3300 Switch	7
	EX3300 Switch Hardware and CLI Terminology Mapping	8
Chapter 2	Component Descriptions	11
	LCD Panel in EX3300 Switches	11
	LCD Panel Modes	12
	LCD Panel Menus	13
	Chassis Status LEDs in EX3300 Switches	16
	Network Port and Uplink Port LEDs in EX3300 Switches	17
	Management Port LEDs in EX3300 Switches	20
	Power Supply in EX3300 Switches	21
	Cooling System and Airflow in an EX3300 Switch	22
Chapter 3	Component Specifications	25
	USB Port Specifications for an EX Series Switch	25
	Network Port Connector Pinout Information for an EX3300 Switch	26
	Console Port Connector Pinout Information for an EX Series	27
	RJ-45 to DB-9 Serial Port Adapter Pinout Information for an EX Series	28
	Switch	28
	Management Port Connector Pinout Information for an EX3300 Switch	29

	Optical Interface Support in EX3300 Switches	30
	SFP+ Direct Attach Cables for EX Series Switches	46
	Cable Specifications	47
	Standards Supported by These Cables	50
Part 2	Planning for Switch Installation	
Chapter 4	Site Preparation	53
	Site Preparation Checklist for EX3300 Switches	53
	General Site Guidelines	54
	Site Electrical Wiring Guidelines	55
	Environmental Requirements and Specifications for EX Series Switches	57
Chapter 5	Mounting and Clearance Requirements	61
	Rack Requirements for EX3300 Switches	61
	Cabinet Requirements for EX3300 Switches	62
	Requirements for Mounting an EX3300 Switch on a Desktop or Wall	63
	Clearance Requirements for Airflow and Hardware Maintenance for EX3300 Switches	64
Chapter 6	Cable Specifications	67
	Network Cable Specifications for EX3300 Switches	67
Chapter 7	Planning Power Requirements	69
	Power Specifications for EX3300 Switches	69
	AC Power Cord Specifications for EX3300 Switches	70
Chapter 8	Planning the Virtual Chassis	73
	Understanding EX3300 Virtual Chassis Hardware Configuration	73
	Planning EX3300 Virtual Chassis	74
	Virtual Chassis Cabling Configuration Examples for EX3300 Switches	74
Part 3	Installing and Connecting the Switch and Switch Components	
Chapter 9	Installing the Switch	79
	Installing and Connecting an EX3300 Switch	79
	Unpacking an EX3300 Switch	80
	Parts Inventory (Packing List) for an EX3300 Switch	81
	Mounting an EX3300 Switch	82
	Mounting an EX3300 Switch on Two Posts in a Rack or Cabinet	82
	Mounting an EX3300 Switch on Four Posts in a Rack or Cabinet	85
	Mounting an EX3300 Switch in a Recessed Position in a Rack or Cabinet	88
	Mounting an EX3300 Switch on a Desk or Other Level Surface	88
	Mounting an EX3300 Switch on a Wall	89
Chapter 10	Installing Switch Components	93
	Installing a Transceiver in an EX Series Switch	93

Chapter 11	Connecting the Switch	97
	Connecting Earth Ground to an EX Series Switch	97
	Parts and Tools Required for Connecting an EX Series Switch to Earth Ground	98
	Special Instructions to Follow Before Connecting Earth Ground to a Switch	99
	Connecting Earth Ground to an EX Series Switch	101
	Connecting AC Power to an EX3300 Switch	102
	Connecting DC Power to an EX3300 Switch	103
	Connecting an EX Series Switch to a Network for Out-of-Band Management . .	106
	Connecting an EX Series Switch to a Management Console	107
	Connecting a Fiber-Optic Cable to an EX Series Switch	109
Chapter 12	Performing Initial Configuration	113
	EX3300 Switch Default Configuration	113
	Connecting and Configuring an EX Series Switch (CLI Procedure)	118
	Connecting and Configuring an EX Series Switch (J-Web Procedure)	120
Part 4	Removing Switch Components	
Chapter 13	Removing Switch Components	127
	Removing a Transceiver from an EX Series Switch	127
	Disconnecting a Fiber-Optic Cable from an EX Series Switch	129
Part 5	Switch and Component Maintenance	
Chapter 14	Routine Maintenance	133
	Maintaining Fiber-Optic Cables in EX Series Switches	133
Part 6	Returning Hardware	
Chapter 15	Returning the Switch or Switch Components	137
	Returning an EX3300 Switch or Component for Repair or Replacement	137
	Locating the Serial Number on an EX3300 Switch or Component	138
	Listing the Switch and Components Details with the CLI	138
	Locating the Chassis Serial Number ID Label on an EX3300 Switch	139
	Contacting Customer Support to Obtain Return Materials Authorization for EX Series Switches	139
	Packing an EX3300 Switch or Component for Shipping	141
	Packing a Switch for Shipping	141
	Packing Switch Components for Shipping	142
Part 7	Safety Information	
Chapter 16	General Safety Information	145
	General Safety Guidelines and Warnings	145
	Definitions of Safety Warning Levels	146
	Fire Safety Requirements	148
	Qualified Personnel Warning	149
	Warning Statement for Norway and Sweden	150

Chapter 17	Radiation and Laser Warnings	151
	Laser and LED Safety Guidelines and Warnings for EX Series Switches	151
	General Laser Safety Guidelines	151
	Class 1 Laser Product Warning	151
	Laser Beam Warning	152
	Radiation from Open Port Apertures Warning	153
Chapter 18	Installation and Maintenance Safety Information	155
	Installation Instructions Warning	155
	Chassis Lifting Guidelines for EX3300 Switches	157
	Ramp Warning	157
	Rack-Mounting and Cabinet-Mounting Warnings	158
	Wall-Mounting Warning for EX3300 Switches	162
	Grounded Equipment Warning	162
	Maintenance and Operational Safety Guidelines and Warnings	163
	Battery Handling Warning	163
	Jewelry Removal Warning	164
	Lightning Activity Warning	166
	Operating Temperature Warning	166
	Product Disposal Warning	168
Chapter 19	Power and Electrical Safety Information	169
	General Electrical Safety Guidelines and Warnings	169
	Prevention of Electrostatic Discharge Damage	170
	AC Power Electrical Safety Guidelines	172
	AC Power Disconnection Warning	174
	DC Power Electrical Safety Guidelines	175
	DC Power Disconnection Warning	176
	DC Power Grounding Requirements and Warning	178
	DC Power Wiring Sequence Warning	179
	DC Power Wiring Terminations Warning	181
	TN Power Warning	182
	Action to Take After an Electrical Accident	183
Part 8	Compliance Information	
Chapter 20	Compliance Information	187
	Agency Approvals for EX Series Switches	187
	Compliance Statements for EMC Requirements for EX Series Switches	188
	Canada	188
	European Community	189
	Japan	189
	Korea	189
	United States	190
	FCC Part 15 Statement	190
	Nonregulatory Environmental Standards	190
	Compliance Statements for Acoustic Noise for EX Series Switches	191
	Declaration of Conformity for EX3300 Switches	192

List of Figures

Part 1	Switch and Components Overview and Specifications	
Chapter 1	EX3300 Switch Overview	3
	Figure 1: Front Panel of an EX3300 Switch with 48 Gigabit Ethernet Ports	7
	Figure 2: Front Panel of an EX3300 Switch with 24 Gigabit Ethernet Ports	7
	Figure 3: Rear Panel of an EX3300 Switch with an AC Power Supply	8
	Figure 4: Rear Panel of an EX3300 Switch with a DC Power Supply	8
Chapter 2	Component Descriptions	11
	Figure 5: LCD Panel	11
	Figure 6: Chassis Status LEDs in an EX3300 Switch	16
	Figure 7: LEDs on the Network Ports on the Front Panel	17
	Figure 8: LEDs on the Uplink Ports	18
	Figure 9: LEDs on the Management Port on an EX3300 Switch	20
	Figure 10: Front-to-Back Airflow Through the EX3300 Switch Chassis	23
	Figure 11: Back-to-Front Airflow Through the EX3300 Switch Chassis	24
Part 2	Planning for Switch Installation	
Chapter 5	Mounting and Clearance Requirements	61
	Figure 12: Clearance Requirements for Airflow and Hardware Maintenance for EX3300 Switches	64
	Figure 13: Front-to-Back Airflow Through the EX3300 Switch Chassis	65
	Figure 14: Back-to-Front Airflow Through the EX3300 Switch Chassis	65
Chapter 7	Planning Power Requirements	69
	Figure 15: AC Plug Types	71
Chapter 8	Planning the Virtual Chassis	73
	Figure 16: EX3300 Switches Mounted on a Single Rack and Connected in a Ring Topology: Option 1	75
	Figure 17: EX3300 Switches Mounted on a Single Rack and Connected in a Ring Topology: Option 2	75
	Figure 18: EX3300 Switches Mounted on a Single Rack and Connected in a Ring: Option 3	76
	Figure 19: EX3300 Switches Mounted on Adjacent Racks and Connected in a Ring Topology Using Medium and Long Cables: Option 1	76
	Figure 20: EX3300 Switches Mounted on Adjacent Racks and Connected in a Ring Topology Using Medium and Long Cables: Option 2	76
Part 3	Installing and Connecting the Switch and Switch Components	
Chapter 9	Installing the Switch	79

	Figure 21: Attaching the Mounting Bracket Along the Front of the Switch	84
	Figure 22: Mounting the Switch on Two Posts in a Rack	84
	Figure 23: Attaching the Front Bracket to the Side-Rail Bracket	86
	Figure 24: Attaching the Side-Rail Bracket to the Switch Chassis	86
	Figure 25: Mounting the Switch to the Front Posts in a Rack	87
	Figure 26: Sliding the Rear Brackets to the Rear of a Four-Post Rack	87
	Figure 27: Attaching Rubber Feet to a Switch Chassis	89
	Figure 28: Attaching Wall-Mount Brackets to a Switch Chassis	90
	Figure 29: Measurements for Installing Mounting Screws	91
	Figure 30: Mounting the Switch on a Wall	92
Chapter 10	Installing Switch Components	93
	Figure 31: Installing a Transceiver in an EX Series Switch	94
Chapter 11	Connecting the Switch	97
	Figure 32: Connecting the Grounding Lug to an EX4200 Switch on a Four-Post Rack	100
	Figure 33: Connecting a Grounding Cable to an EX Series Switch	101
	Figure 34: Connecting an AC Power Cord Retainer Clip to the AC Power Cord Inlet	103
	Figure 35: Connecting an AC Power Cord to the AC Power Cord Inlet	103
	Figure 36: Securing Ring Lugs to the Terminals on the DC Power Supply	105
	Figure 37: Ethernet Cable Connector	106
	Figure 38: Connecting an EX Series Switch to a Network for Out-of-Band Management	107
	Figure 39: Ethernet Cable Connector	108
	Figure 40: Connecting an EX Series Switch to a Management Console Through a Console Server	109
	Figure 41: Connecting an EX Series Switch Directly to a Management Console	109
	Figure 42: Connecting a Fiber-Optic Cable to an Optical Transceiver Installed in an EX Series Switch	110
Chapter 12	Performing Initial Configuration	113
	Figure 43: LCD Panel in an EX3200, EX4200, EX4500, or EX8200 Switch	121
Part 4	Removing Switch Components	
Chapter 13	Removing Switch Components	127
	Figure 44: Removing a Transceiver from an EX Series Switch	129
Part 6	Returning Hardware	
Chapter 15	Returning the Switch or Switch Components	137
	Figure 45: Location of the Serial Number ID Label on EX3300 Switches	139
Part 7	Safety Information	
Chapter 19	Power and Electrical Safety Information	169
	Figure 46: Place a Component into an Antistatic Bag	171

List of Tables

Part 1	Switch and Components Overview and Specifications	
Chapter 1	EX3300 Switch Overview	3
	Table 1: EX3300 Switch Models	5
	Table 2: Physical Specifications of the EX3300 Switch Chassis	5
	Table 3: CLI Equivalents of Terms Used in Documentation for EX3300 Switches	9
Chapter 2	Component Descriptions	11
	Table 4: LCD Panel Menu Options	13
	Table 5: Chassis Status LEDs in an EX3300 Switch	16
	Table 6: Link/Activity LED on the Network Ports and Uplink Ports in EX3300 Switches	18
	Table 7: Status LED on the Network Ports in EX3300 Switches	19
	Table 8: Status LED on the Uplink Ports in EX3300 Switches	20
	Table 9: Link/Activity LED on the Management Port on an EX3300 Switch	21
	Table 10: Status LED on the Management Port on an EX3300 Switch	21
	Table 11: Power Consumed by EX3300 Switches	21
	Table 12: Airflow Direction in EX3300 Switch Models	22
Chapter 3	Component Specifications	25
	Table 13: Network Port Connector Pinout Information for EX3300 Switches	26
	Table 14: EX Series Switches Console Port Connector Pinout Information	27
	Table 15: EX Series Switches RJ-45 to DB-9 Serial Port Adapter Pinout Information	28
	Table 16: Management Port Connector Pinout Information for EX3300 Switches	29
	Table 17: Optical Interface Support for Gigabit Ethernet SFP Transceivers	31
	Table 18: Optical Interface Support for SFP+ Gigabit Ethernet Transceivers	42
	Table 19: Software Support for SFP+ Passive Direct Attach Cables for EX Series Switches	47
	Table 20: SFP+ Direct Attach Cable Specifications	48
Part 2	Planning for Switch Installation	
Chapter 4	Site Preparation	53
	Table 21: Site Preparation Checklist	53
	Table 22: Site Electrical Wiring Guidelines	56
	Table 23: EX Series Switch Environmental Tolerances	57
Chapter 5	Mounting and Clearance Requirements	61
	Table 24: Rack Requirements and Specifications for the Switch	61

	Table 25: Cabinet Requirements and Specifications for the Switch	63
Chapter 7	Planning Power Requirements	69
	Table 26: AC Power Supply Electrical Specifications for EX3300 Switches	69
	Table 27: DC Power Supply Electrical Specifications for EX3300 Switches	69
	Table 28: AC Power Cord Specifications	70
Part 3	Installing and Connecting the Switch and Switch Components	
Chapter 9	Installing the Switch	79
	Table 29: Parts List for an EX3300 Switch	81
Chapter 11	Connecting the Switch	97
	Table 30: Parts and Tools Required for Connecting an EX Series Switch to Earth Ground	98
	Table 31: Special Instructions to Follow Before Connecting Earth Ground to a Switch	99

About This Topic Collection

- How to Use This Guide on page xiii
- List of EX Series Guides for Junos OS Release 12.2 on page xiii
- Downloading Software on page xvi
- Documentation Symbols Key on page xvi
- Documentation Feedback on page xviii
- Requesting Technical Support on page xviii

How to Use This Guide

Complete documentation for the EX Series product family is provided on webpages at http://www.juniper.net/techpubs/en_US/release-independent/information-products/pathway-pages/ex-series/product/index.html. We have selected content from these webpages and created a number of EX Series guides that collect related topics into a book-like format so that the information is easy to print and easy to download to your local computer.

Software features for EX Series switches and EX Series Virtual Chassis are listed by platform and by Junos OS release in two standalone documents. See [EX Series Switch Software Features Overview](#) and [EX Series Virtual Chassis Software Features Overview](#).

This guide, *Complete Hardware Guide for EX3300 Ethernet Switches*, collects together information about the EX3300 virtual-chassis switches. The release notes are at http://www.juniper.net/techpubs/en_US/junos12.2/information-products/topic-collections/release-notes/12.2/junos-release-notes-12.2.pdf.

List of EX Series Guides for Junos OS Release 12.2

Title	Description
<i>Complete Guide for the EX Series Redundant Power System</i>	Hardware descriptions, site preparation, installation, replacement, software features and configuration, and safety and compliance information for EX Series RPS.
<i>Complete Hardware Guide for EX2200 Ethernet Switches</i>	Component descriptions, site preparation, installation, replacement, and safety and compliance information for EX2200 Ethernet switches

Title	Description
<i>Complete Hardware Guide for EX3200 Ethernet Switches</i>	Component descriptions, site preparation, installation, replacement, and safety and compliance information for EX3200 Ethernet switches
<i>Complete Hardware Guide for EX3300 Ethernet Switches</i>	Component descriptions, site preparation, installation, replacement, and safety and compliance information for EX3300 Ethernet switches
<i>Complete Hardware Guide for EX4200 Ethernet Switches</i>	Component descriptions, site preparation, installation, replacement, and safety and compliance information for EX4200 Ethernet switches
<i>Complete Hardware Guide for EX4500 Ethernet Switches</i>	Component descriptions, site preparation, installation, replacement, and safety and compliance information for EX4500 Ethernet switches
<i>Complete Hardware Guide for EX6210 Ethernet Switches</i>	Component descriptions, site preparation, installation, replacement, and safety and compliance information for EX6210 Ethernet switches
<i>Complete Hardware Guide for EX8208 Ethernet Switches</i>	Component descriptions, site preparation, installation, replacement, and safety and compliance information for EX8208 Ethernet switches
<i>Complete Hardware Guide for EX8216 Ethernet Switches</i>	Component descriptions, site preparation, installation, replacement, and safety and compliance information for EX8216 Ethernet switches
<i>Complete Hardware Guide for the XRE200 External Routing Engine</i>	Component descriptions, site preparation, installation, replacement, and safety and compliance information for the XRE200 External Routing Engine
<i>Complete Software Guide for Junos[®] OS for EX Series Ethernet Switches, Release 12.2</i>	Software feature descriptions, configuration examples, and tasks for Junos OS for EX Series switches
Software Topic Collections	Software feature descriptions, configuration examples and tasks, and reference pages for configuration statements and operational commands (This information also appears in the <i>Complete Software Guide for Junos[®] OS for EX Series Ethernet Switches, Release 12.2.</i>)
<hr/>	
<i>Junos[®] OS Access Privilege Configuration Guide</i>	
<i>Junos[®] OS for EX Series Ethernet Switches, Release 12.2: Access and User Management</i>	
<i>Junos[®] OS for EX Series Ethernet Switches, Release 12.2: Access Control</i>	
<i>Junos[®] OS for EX Series Ethernet Switches, Release 12.2: Configuration Management</i>	





Title	Description
<i>Junos[®] OS for EX Series Ethernet Switches, Release 12.2: Class of Service</i>	
<i>Junos[®] OS for EX Series Ethernet Switches, Release 12.2: Device Security</i>	
<i>Junos[®] OS for EX Series Ethernet Switches, Release 12.2: Ethernet Switching</i>	
<i>Junos[®] OS for EX Series Ethernet Switches, Release 12.2: EX2200, EX3300, EX4200, EX4500, and EX4550 Virtual Chassis</i>	
<i>Junos[®] OS for EX Series Ethernet Switches, Release 12.2: EX8200 Virtual Chassis</i>	
<i>Junos[®] OS for EX Series Ethernet Switches, Release 12.2: Converged Networks (LAN and SAN)</i>	
<i>Junos[®] OS for EX Series Ethernet Switches, Release 12.2: High Availability</i>	
<i>Junos[®] OS for EX Series Ethernet Switches, Release 12.2: Interfaces</i>	
<i>Junos[®] OS for EX Series Ethernet Switches, Release 12.2: Layer 3 Protocols</i>	
<i>Junos[®] OS for EX Series Ethernet Switches, Release 12.2: MPLS</i>	
<i>Junos[®] OS for EX Series Ethernet Switches, Release 12.2: Multicast</i>	
<i>Junos[®] OS for EX Series Switches, Release 12.2: Network Management and Monitoring</i>	
<i>Junos[®] OS for EX Series Switches, Release 12.2: Port Security</i>	
<i>Junos[®] OS for EX Series Switches, Release 12.2: Power over Ethernet</i>	
<i>Junos[®] OS for EX Series Ethernet Switches, Release 12.2: Routing Policy and Packet Filtering</i>	
<i>Junos[®] OS for EX Series Ethernet Switches, Release 12.2: Software Installation</i>	
<i>Junos[®] OS for EX Series Ethernet Switches, Release 12.2: Spanning-Tree Protocols</i>	
<i>Junos[®] OS for EX Series Ethernet Switches, Release 12.2: System Monitoring</i>	

Title	Description
<i>Junos® OS for EX Series Ethernet Switches, Release 12.2: System Services</i>	
<i>Junos® OS for EX Series Ethernet Switches, Release 12.2: System Setup</i>	
<i>Junos® OS for EX Series Ethernet Switches, Release 12.2: User Interfaces</i>	

Downloading Software

You can download Junos OS for EX Series switches from the Download Software area at <http://www.juniper.net/customers/support/>. To download the software, you must have a Juniper Networks user account. For information about obtaining an account, see <http://www.juniper.net/entitlement/setupAccountInfo.do>.

Documentation Symbols Key

Notice Icons		
Icon	Meaning	Description
	Informational note	Indicates important features or instructions.
	Caution	Indicates a situation that might result in loss of data or hardware damage.
	Warning	Alerts you to the risk of personal injury or death.
	Laser warning	Alerts you to the risk of personal injury from a laser.

Text and Syntax Conventions		
Convention	Description	Examples
Bold text like this	Represents text that you type.	To enter configuration mode, type the configure command: <code>user@host> configure</code>
Fixed-width text like this	Represents output that appears on the terminal screen.	<code>user@host> show chassis alarms</code> <code>No alarms currently active</code>

Text and Syntax Conventions		
Convention	Description	Examples
<i>Italic text like this</i>	<ul style="list-style-type: none"> Introduces important new terms. Identifies book names. Identifies RFC and Internet draft titles. 	<ul style="list-style-type: none"> A policy <i>term</i> is a named structure that defines match conditions and actions. <i>Junos OS System Basics Configuration Guide</i> RFC 1997, <i>BGP Communities Attribute</i>
<i>Italic text like this</i>	Represents variables (options for which you substitute a value) in commands or configuration statements.	Configure the machine's domain name: [edit] root@# set system domain-name <i>domain-name</i>
Plain text like this	Represents names of configuration statements, commands, files, and directories; IP addresses; configuration hierarchy levels; or labels on routing platform components.	<ul style="list-style-type: none"> To configure a stub area, include the stub statement at the [edit protocols ospf area area-id] hierarchy level. The console port is labeled CONSOLE.
< > (angle brackets)	Enclose optional keywords or variables.	stub <default-metric <i>metric</i> >;
(pipe symbol)	Indicates a choice between the mutually exclusive keywords or variables on either side of the symbol. The set of choices is often enclosed in parentheses for clarity.	broadcast multicast (string1 string2 string3)
# (pound sign)	Indicates a comment specified on the same line as the configuration statement to which it applies.	rsvp { # Required for dynamic MPLS only
[] (square brackets)	Enclose a variable for which you can substitute one or more values.	community name members [community-ids]
Indentation and braces ({ })	Identify a level in the configuration hierarchy.	[edit] routing-options { static { route default { nexthop <i>address</i> ; retain; } } }
;(semicolon)	Identifies a leaf statement at a configuration hierarchy level.	
J-Web GUI Conventions		
Bold text like this	Represents J-Web graphical user interface (GUI) items you click or select.	<ul style="list-style-type: none"> In the Logical Interfaces box, select All Interfaces. To cancel the configuration, click Cancel.

Text and Syntax Conventions		
Convention	Description	Examples
> (bold right angle bracket)	Separates levels in a hierarchy of J-Web selections.	In the configuration editor hierarchy, select Protocols>Ospf .

Documentation Feedback

We encourage you to provide feedback, comments, and suggestions so that we can improve the documentation. Send e-mail to techpubs-comments@juniper.net with the following:

- Document URL or title
- Page number if applicable
- Software version
- Your name and company

Requesting Technical Support

Technical product support is available through the Juniper Networks Technical Assistance Center (JTAC). If you are a customer with an active J-Care or JNASC support contract, or are covered under warranty, and need post-sales technical support, you can access our tools and resources online or open a case with JTAC.

- JTAC policies—For a complete understanding of our JTAC procedures and policies, review the *JTAC User Guide* located at <http://www.juniper.net/us/en/local/pdf/resource-guides/7100059-en.pdf> .
- Product warranties—For product warranty information, visit <http://www.juniper.net/support/warranty/> .
- JTAC hours of operation—The JTAC centers have resources available 24 hours a day, 7 days a week, 365 days a year.

Self-Help Online Tools and Resources

For quick and easy problem resolution, Juniper Networks has designed an online self-service portal called the Customer Support Center (CSC) that provides you with the following features:

- Find CSC offerings: <http://www.juniper.net/customers/support/>
- Search for known bugs: <http://www2.juniper.net/kb/>
- Find product documentation: <http://www.juniper.net/techpubs/>
- Find solutions and answer questions using our Knowledge Base: <http://kb.juniper.net/>

- Download the latest versions of software and review release notes:
<http://www.juniper.net/customers/csc/software/>
- Search technical bulletins for relevant hardware and software notifications:
<https://www.juniper.net/alerts/>
- Join and participate in the Juniper Networks Community Forum:
<http://www.juniper.net/company/communities/>
- Open a case online in the CSC Case Management tool: <http://www.juniper.net/cm/>

To verify service entitlement by product serial number, use our Serial Number Entitlement (SNE) Tool: <https://tools.juniper.net/SerialNumberEntitlementSearch/>

Opening a Case with JTAC

You can open a case with JTAC on the Web or by telephone.

- Use the Case Management tool in the CSC at <http://www.juniper.net/cm/> .
- Call 1-888-314-JTAC (1-888-314-5822 toll-free in the USA, Canada, and Mexico).

For international or direct-dial options in countries without toll-free numbers, see <http://www.juniper.net/support/requesting-support.html> .

PART 1

Switch and Components Overview and Specifications

- [EX3300 Switch Overview on page 3](#)
- [Component Descriptions on page 11](#)
- [Component Specifications on page 25](#)

CHAPTER 1

EX3300 Switch Overview

- [EX3300 Switches Hardware Overview on page 3](#)
- [EX3300 Switch Models on page 4](#)
- [Chassis Physical Specifications for EX3300 Switches on page 5](#)
- [Front Panel of an EX3300 Switch on page 6](#)
- [Rear Panel of an EX3300 Switch on page 7](#)
- [EX3300 Switch Hardware and CLI Terminology Mapping on page 8](#)

EX3300 Switches Hardware Overview

Juniper Networks EX Series Ethernet Switches provide scalable connectivity for the enterprise market, including branch offices, campus locations, and data centers. The switches run the Juniper Networks Junos operating system (Junos OS), which provides Layer 2 and Layer 3 switching, routing, and security services. The same Junos OS code base that runs on EX Series switches also runs on all Juniper Networks J Series, M Series, MX Series, and T Series routers and SRX Series services gateways.

Juniper Networks EX3300 Ethernet Switches provide connectivity for low-density environments.

This topic describes:

- [EX3300 Switches First View on page 3](#)
- [Uplink Ports on page 4](#)
- [Power over Ethernet Plus Ports on page 4](#)

EX3300 Switches First View

EX3300 switches provide:

- Either 24 or 48 built-in network ports with 10/100/1000BASE-T Gigabit Ethernet connectors (ports labeled 0 through 23 or 0 through 47)
- Four uplink ports (ports labeled 0 through 3)
- Virtual Chassis capability—You can connect up to ten EX3300 switches together to form one unit that you manage as a single chassis, called a *Virtual Chassis*.
- Power over Ethernet Plus (PoE+) on all network ports (in PoE+-capable models only)

Uplink Ports

Each EX3300 switch has four autosensing uplink ports. You can use the uplink ports on the switch to:

- Connect an access switch to a distribution switch
- Interconnect member switches of a Virtual Chassis

The uplink ports labeled 0 and 1 (interfaces **ge-0/1/0** and **ge-0/1/1** or **xe-0/1/0** and **xe-0/1/1**) are configured by default as network ports. To use uplink ports 0 and 1 to interconnect Virtual Chassis members, you must configure them as Virtual Chassis ports (VCPs).

The uplink ports labeled 2 and 3 (interfaces **ge-0/1/2** and **ge-0/1/3** or **xe-0/1/2** and **xe-0/1/3**) are configured by default as VCPs. You can use these uplink ports to interconnect Virtual Chassis members. To use uplink ports 2 and 3 as network ports, you must configure them as network ports.

The uplink ports support SFP and SFP+ transceivers. For a list of supported transceivers, see [“Optical Interface Support in EX3300 Switches” on page 30](#).

Power over Ethernet Plus Ports

EX3300 switches are available in models with or without PoE+ capability. Models that support PoE+ provide that support on all network ports.

PoE+ ports provide electrical current to devices—such as IP phones, wireless access points, and security cameras—through network cables, thus eliminating the need for separate power cords for those devices.



NOTE: IEEE 802.3af and IEEE 802.3at powered devices require category 5 or higher Ethernet cables.

Related Documentation

- [EX3300 Switch Models on page 4](#)
- [Site Preparation Checklist for EX3300 Switches on page 53](#)

EX3300 Switch Models

The EX3300 switch models are available:

- With 24 or 48 network ports
- With or without PoE+ capability
- With front-to-back or back-to-front airflow
- With AC or DC power supplies

[Table 1 on page 5](#) lists the EX3300 switch models.

Table 1: EX3300 Switch Models

Model	Access Ports	Ports in Which PoE+ Is Available	Maximum System Power Available for PoE	Direction of Airflow	First Junos OS Release
EX3300-24T	24 Gigabit Ethernet	–	–	Front-to-back	11.3R1
EX3300-24P	24 Gigabit Ethernet	All 24 ports	405 W	Front-to-back	11.3R1
EX3300-24T-DC	24 Gigabit Ethernet	–	–	Front-to-back	11.3R1
EX3300-48T	48 Gigabit Ethernet	–	–	Front-to-back	11.3R1
EX3300-48T-BF	48 Gigabit Ethernet	–	–	Back-to-front	11.3R1
EX3300-48P	48 Gigabit Ethernet	All 48 ports	740 W	Front-to-back	11.3R1



NOTE: In rare cases, EX3300 switches running a Junos OS release prior to Release 11.3R4 or Release 11.4R2 might experience some traffic loss or a link failure as a result of non-user-configurable settings that are not optimized. To resolve this issue, upgrade to one of the following Junos OS releases:

- Junos OS Release 11.3—R4 and later
- Junos OS Release 11.4—R2 and later
- Junos OS Release 12.1—R1 and later

- Related Documentation**
- [Front Panel of an EX3300 Switch on page 6](#)
 - [EX3300 Switches Hardware Overview on page 3](#)

Chassis Physical Specifications for EX3300 Switches

The EX3300 switch chassis is a rigid sheet-metal structure that houses the hardware components. [Table 2 on page 5](#) summarizes the physical specifications of the EX3300 switch chassis.

Table 2: Physical Specifications of the EX3300 Switch Chassis

Description	Value
Chassis height	1.75 in. (4.45 cm)
Chassis width	<ul style="list-style-type: none"> • 17.5 in. (44.5 cm) • 19 in. (48.2 cm) with mounting brackets attached
Chassis depth	12 in. (30.5 cm)

Table 2: Physical Specifications of the EX3300 Switch Chassis (*continued*)

Description	Value
Weight	<ul style="list-style-type: none"> EX3300-24T: 10 lb (4.6 kg) EX3300-24P: 11.6 lb (5.3 kg) EX3300-24T-DC: 9.8 lb (4.5 kg) EX3300-48T: 10.8 lb (4.9 kg) EX3300-48T-BF: 10.8 lb (4.9 kg) EX3300-48P: 12.8 lb (5.8 kg)

- Related Documentation**
- [Rack Requirements for EX3300 Switches on page 61](#)
 - [Cabinet Requirements for EX3300 Switches on page 62](#)
 - [Mounting an EX3300 Switch on page 82](#)
 - [Installing and Connecting an EX3300 Switch on page 79](#)

Front Panel of an EX3300 Switch

The front panel of an EX3300 switch consists of the following components:

- Network ports:
 - Depending on the switch model, 24 or 48 10/100/1000BASE-T Gigabit Ethernet ports (ports labeled 0 through 23 or 0 through 47)
 - Power over Ethernet Plus (PoE+) available in all network ports in EX3300-24P and EX3300-48P models
 - Power over Ethernet Plus (PoE+) not available in any network port in EX3300-24T, EX3300-24T-DC, EX3300-48T, and EX3300-48T-BF models
- Four built-in uplink ports:
 - The uplink ports support 1-gigabit small form-factor pluggable (SFP) transceivers, 10-gigabit small form-factor pluggable (SFP+) transceivers, or a combination of these transceivers.
 - Ports labeled 0 and 1 are, by default, configured as network ports. You can configure these ports as Virtual Chassis ports (VCPs).
 - Ports labeled 2 and 3 are, by default, configured as VCPs. You can configure these ports as network ports.
- Network port and uplink port LEDs
- Three chassis status LEDs
- LCD panel and the LCD navigation buttons
- Air intake or air exhaust, depending on the switch model—The intake or exhaust is located immediately below the top edge of the front panel.

Figure 1 on page 7 shows the front panel of an EX3300 switch with 48 Gigabit Ethernet ports. Figure 2 on page 7 shows the front panel of an EX3300 switch with 24 Gigabit Ethernet ports.

Figure 1: Front Panel of an EX3300 Switch with 48 Gigabit Ethernet Ports

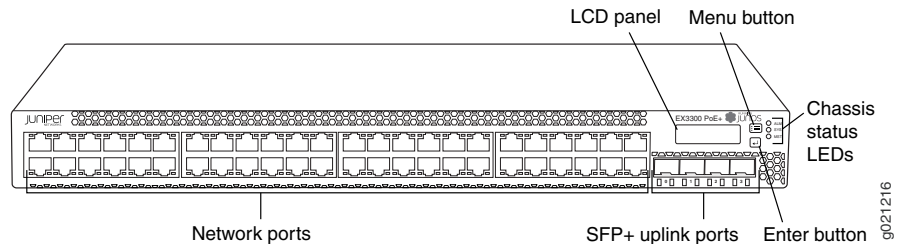
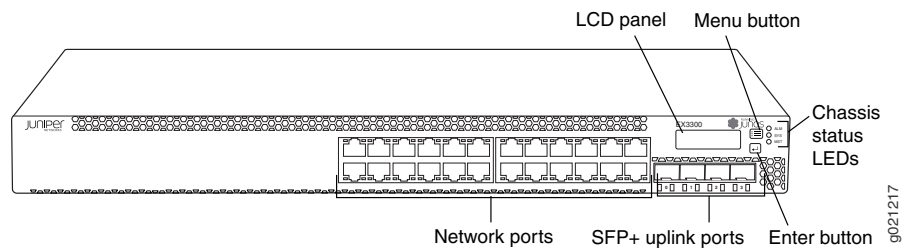

Figure 2: Front Panel of an EX3300 Switch with 24 Gigabit Ethernet Ports



Related Documentation

- [Chassis Status LEDs in EX3300 Switches on page 16](#)
- [Network Port and Uplink Port LEDs in EX3300 Switches on page 17](#)
- [Network Port Connector Pinout Information for an EX3300 Switch on page 26](#)
- [Rear Panel of an EX3300 Switch on page 7](#)
- [EX2200, EX3300, EX4200, EX4500, and EX4550 Virtual Chassis Overview](#)
- [Installing a Transceiver in an EX Series Switch on page 93](#)
- [Removing a Transceiver from an EX Series Switch on page 127](#)
- [Installing and Connecting an EX3300 Switch on page 79](#)

Rear Panel of an EX3300 Switch

The rear panel of the EX3300 switch consists of the following components:

- Management Ethernet port
- USB port
- Console port
- Protective earthing terminal
- ESD point
- Air intake or air exhaust, depending on the switch model

- Serial number ID label
- AC power cord inlet or DC power terminal block

Figure 3 on page 8 shows the rear panel of an EX3300 switch with AC power supply.

The power cord retainer extends out of the chassis by 3 in. (7.62 cm).

Figure 3: Rear Panel of an EX3300 Switch with an AC Power Supply

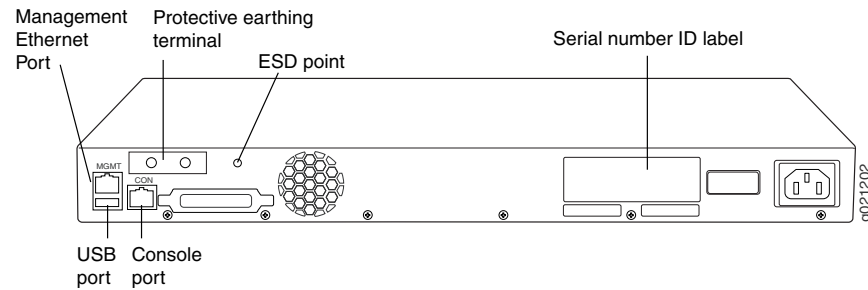
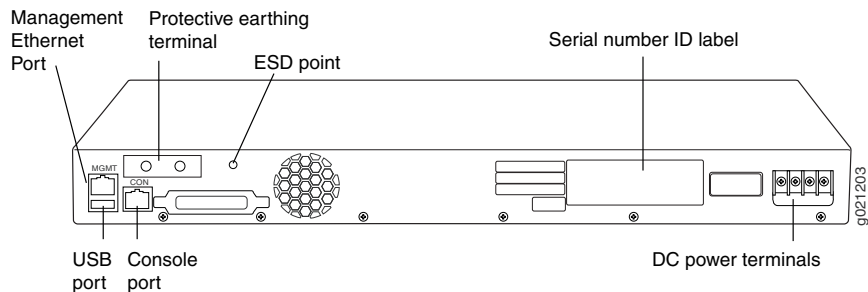

Figure 4 on page 8 shows the rear panel of an EX3300 switch with DC power supply.

Figure 4: Rear Panel of an EX3300 Switch with a DC Power Supply



Related Documentation

- [Front Panel of an EX3300 Switch on page 6](#)
- [USB Port Specifications for an EX Series Switch on page 25](#)
- [Cooling System and Airflow in an EX3300 Switch on page 22](#)
- [Power Supply in EX3300 Switches on page 21](#)
- [Prevention of Electrostatic Discharge Damage on page 170](#)
- [Connecting Earth Ground to an EX Series Switch on page 97](#)
- [Installing and Connecting an EX3300 Switch on page 79](#)

EX3300 Switch Hardware and CLI Terminology Mapping

This topic describes the hardware terms used in EX3300 switch documentation and the corresponding terms used in the Junos OS command line interface (CLI). See [Table 3 on page 9](#).

Table 3: CLI Equivalents of Terms Used in Documentation for EX3300 Switches

Hardware Item (Field as Displayed in CLI)	Description (Field as Displayed in CLI)	Value (Field as Displayed in CLI)	Item in Documentation	Additional Information
Chassis	<p>One of the following:</p> <ul style="list-style-type: none"> EX3300-24T EX3300-24P EX3300-24T-DC EX3300-48T EX3300-48T-BF EX3300-48P 	–	Switch chassis	“Chassis Physical Specifications for EX3300 Switches” on page 5
FPC (<i>n</i>)	<p>On EX3300 standalone switches:</p> <p>Abbreviated name of the Flexible PIC Concentrator (FPC)</p> <p>One of the following:</p> <ul style="list-style-type: none"> EX3300-24T EX3300-24P EX3300-24T-DC EX3300-48T EX3300-48T-BF EX3300-48P 	Value of <i>n</i> is always 0.	The switch does not have actual FPCs. In this case, FPC refers to the switch itself.	Understanding Interface Naming Conventions on EX Series Switches
	<p>On EX3300 Virtual Chassis:</p> <ul style="list-style-type: none"> Member ID of the switch within the Virtual Chassis 	<i>n</i> is a value in the range of 0–9.	In this case, the FPC number refers to the member ID assigned to the switch.	Understanding EX2200, EX3300, EX4200, EX4500, and EX4550 Virtual Chassis Components
PIC (<i>n</i>)	<p>Abbreviated name of the Physical Interface Card (PIC)</p>	<i>n</i> is a value in the range of 0–1.	The switch does not have actual PIC devices; see entries for PIC 0 through PIC 1 for the equivalent item on the switch.	Understanding Interface Naming Conventions on EX Series Switches
	<p>One of the following:</p> <ul style="list-style-type: none"> 24x 10/100/1000 BASE-T 48x 10/100/1000 BASE-T 	PIC 0	Built-in network ports on the front panel of the switch	“Front Panel of an EX3300 Switch” on page 6
	4x GE/XE SFP+	PIC 1	Built-in uplink ports on the front panel of the switch	“Front Panel of an EX3300 Switch” on page 6

Table 3: CLI Equivalents of Terms Used in Documentation for EX3300 Switches (*continued*)

Hardware Item (Field as Displayed in CLI)	Description (Field as Displayed in CLI)	Value (Field as Displayed in CLI)	Item in Documentation	Additional Information
Xcvr (<i>n</i>)	Abbreviated name of the transceiver	<i>n</i> is a value equivalent to the number of the port in which the transceiver is installed.	Optical transceivers	"Optical Interface Support in EX3300 Switches" on page 30
Power Supply (<i>n</i>)	Built-in power supply	Value of <i>n</i> is always 0.	Power supply	"Power Supply in EX3300 Switches" on page 21
Fan Tray	Built-in fan tray	–	Fan tray	"Cooling System and Airflow in an EX3300 Switch" on page 22

- Related Documentation**
- [EX Series Switches Hardware and CLI Terminology Mapping](#)
 - [EX3300 Switches Hardware Overview on page 3](#)

CHAPTER 2

Component Descriptions

- LCD Panel in EX3300 Switches on page 11
- Chassis Status LEDs in EX3300 Switches on page 16
- Network Port and Uplink Port LEDs in EX3300 Switches on page 17
- Management Port LEDs in EX3300 Switches on page 20
- Power Supply in EX3300 Switches on page 21
- Cooling System and Airflow in an EX3300 Switch on page 22

LCD Panel in EX3300 Switches

The LCD panel on the front panel of the switch shows two lines of text, each of which can contain a maximum of 16 characters. The LCD panel displays a variety of information about the switch and also provides a menu to perform basic operations such as initial setup and reboot.

There are two navigation buttons—**Menu** and **Enter**—to the right of the LCD panel.

See [Figure 5 on page 11](#).

Figure 5: LCD Panel

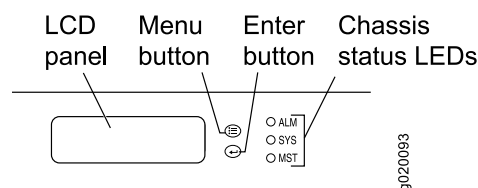

You can configure the second line of the LCD panel to display a custom message. If the LCD panel is configured to display a custom message, the **Menu** button and the **Enter** button are disabled. See [Configuring the LCD Panel on EX Series Switches \(CLI Procedure\)](#).

The LCD panel has a backlight. If the LCD panel is idle for 60 seconds, the backlight turns off. You can turn on the backlight by pressing the **Menu** or **Enter** button once. After turning on the backlight, you can toggle between the LCD panel menus by pressing the **Menu** button and navigate through the menu options by pressing the **Enter** button.

This topic describes:

- [LCD Panel Modes on page 12](#)
- [LCD Panel Menus on page 13](#)

LCD Panel Modes

The LCD panel operates in four modes: boot, idle, status, and maintenance.

The LCD panel operates in boot mode during switch reboot. The boot mode displays the key milestones in the switch boot process. The boot mode does not have any menu options. After the boot process is complete, the LCD panel automatically reverts to the Idle menu.

In an EX3300 switch that is not a member of a Virtual Chassis, the first line of the LCD panel displays:

- The slot number—For a standalone EX3300 switch, the slot number is always **00**.
- The role of the switch—For a standalone EX3300 switch, the role is always **RE** (for master).
- Hostname

In an EX3300 switch that is a member of a Virtual Chassis, the first line of the LCD panel displays:

- The slot number (the member ID for the Virtual Chassis member)
- Role of the switch in a Virtual Chassis (**RE** for master, **BK** for backup, and **LC** for linecard member)
- Hostname

In the idle mode, the second line displays the mode of the network ports' Status LED and the number of chassis alarms. The number of alarms is updated every second.

In the status mode, the second line displays:

- Virtual Chassis port (VCP) status (for an EX3300 switch that is a member of a Virtual Chassis)
- Status of the power supply
- Status of the fan and temperature
- Version of Junos OS for EX Series switches loaded on the switch

In the maintenance mode, the second line displays one of the following options that you can use to configure and troubleshoot the switch:

- System halt
- System reboot
- Load rescue

- Request VC port (for an EX3300 switch that is a member of a Virtual Chassis)
- Factory default
- System EZSetup

LCD Panel Menus

The LCD panel has three menus: Idle, Status, and Maintenance. Toggle between the LCD panel menus by pressing the **Menu** button. Navigate through the menu options by pressing the **Enter** button.

[Table 4 on page 13](#) describes the LCD panel menu options.

Table 4: LCD Panel Menu Options

Menu	Description
IDLE	<p>In the Idle menu:</p> <ul style="list-style-type: none"> • Press Enter to cycle through the Status LED modes: <ul style="list-style-type: none"> • SPD (speed) • ADM (administrative status) • DPX (duplex) • POE (Power over Ethernet) <p>See "Network Port and Uplink Port LEDs in EX3300 Switches" on page 17 for information on the Status LED modes.</p> • Press Menu to exit the Idle menu and go to the Status menu.

Table 4: LCD Panel Menu Options (*continued*)

Menu	Description
STATUS	<p>The Status menu has the following options:</p> <ul style="list-style-type: none"> • Show VCP status—Choose one of the following: <ul style="list-style-type: none"> • Press the Enter button to display the Virtual Chassis port (VCP) status: Up, Down, Disabled. <p>NOTE: This option is available only for an EX3300 switch that is a member of a Virtual Chassis configuration.</p> <ul style="list-style-type: none"> • Press the Menu button to go to the next option in the Status menu. <ul style="list-style-type: none"> • Show PSU status—Choose one of the following: <ul style="list-style-type: none"> • Press the Enter button to display the status of the power supply: OK, Failed, Absent. • Press the Menu button to go to the next option in the Status menu. • Show Environment status—Choose one of the following: <ul style="list-style-type: none"> • Press the Enter button to display the status of the fan and temperature: <ul style="list-style-type: none"> • Fan status: OK, Failed, Absent • Temp status: OK, High, Shutdown • Press the Menu button to go to the next option in the Status menu. • Show Junos version—Choose one of the following: <ul style="list-style-type: none"> • Press the Enter button to display the version of Junos OS for EX Series switches loaded on the switch. • Press the Menu button to go to the next option in the Status menu. • EXIT STAT MENU?—Choose one of the following: <ul style="list-style-type: none"> • Press the Enter button to exit the Status menu. Then press the Menu button to go to the Maintenance menu. • On an EX3300 switch that is a member of a Virtual Chassis configuration, press the Menu button to return to the Show VCP status option. <p>NOTE: This option is available only for an EX3300 switch that is a member of a Virtual Chassis configuration.</p> <p>If you do not want users to use Status menu options, disable the entire menu or individual menu options. See <i>Configuring the LCD Panel on EX Series Switches (CLI Procedure)</i>.</p>

Table 4: LCD Panel Menu Options (*continued*)

Menu	Description
MAINT (Maintenance Menu)	<p>The Maintenance menu has the following options to configure and troubleshoot the switch:</p> <ul style="list-style-type: none"> • SYSTEM HALT?—Choose one of the following: <ul style="list-style-type: none"> • Press the Enter button to halt the switch. Press the Enter button again to confirm the halt. • Press the Menu button to go to the next option in the Maintenance menu. • SYSTEM REBOOT?—Choose one of the following: <ul style="list-style-type: none"> • Press the Enter button to reboot the switch. Press the Enter button again to confirm the reboot. • Press the Menu button to go to the next option in the Maintenance menu. • LOAD RESCUE?—Choose one of the following: <ul style="list-style-type: none"> • Press the Enter button to roll back the switch to the rescue configuration. Press the Enter button again to confirm the rollback. • Press the Menu button to go to the next option in the Maintenance menu. • REQUEST VC PORT?—Choose one of the following: <ul style="list-style-type: none"> • Press the Enter button to configure an uplink port in an EX3300 switch or to delete a VCP from the switch configuration. <p>NOTE: This option is available only for an EX3300 switch that is a member of a Virtual Chassis configuration.</p> <ul style="list-style-type: none"> • Press the Menu button to go to the next option in the Maintenance menu. • FACTORY DEFAULT?—Choose one of the following: <ul style="list-style-type: none"> • Press the Enter button to restore the switch to the factory default configuration. Press the Enter button again to confirm the restoration. • Press the Menu button to go to the next option in the Maintenance menu. • ENTER EZSETUP?—Choose one of the following: <ul style="list-style-type: none"> • Press the Enter button to launch EZSetup. Press the Enter button again to confirm the launch. <p>NOTE: You can use the ENTER EZSETUP option only if the switch is in the factory default configuration. For information about EZSetup, see “Connecting and Configuring an EX Series Switch (J-Web Procedure)” on page 120.</p> <ul style="list-style-type: none"> • Press the Menu button to go to the next option in the Maintenance menu. • EXIT MAINT MENU?—Choose one of the following: <ul style="list-style-type: none"> • Press the Enter button to exit the Maintenance menu. Then press the Menu button to go to the Idle menu. • Press the Menu button to go to the System Halt option. <p>If you do not want users to use Maintenance menu options, disable the entire menu or individual menu options. See Configuring the LCD Panel on EX Series Switches (CLI Procedure).</p>

- Related Documentation**
- [Front Panel of an EX3300 Switch on page 6](#)
 - [Connecting and Configuring an EX Series Switch \(CLI Procedure\) on page 118](#)

Chassis Status LEDs in EX3300 Switches

The front panel of an EX3300 switch has three chassis status LEDs labeled ALM, SYS, and MST on the far right side of the panel, above the uplink ports (see [Figure 6 on page 16](#)).

You can view the colors of the LEDs remotely through the CLI by issuing the operational mode command `show chassis lcd`.

Figure 6: Chassis Status LEDs in an EX3300 Switch

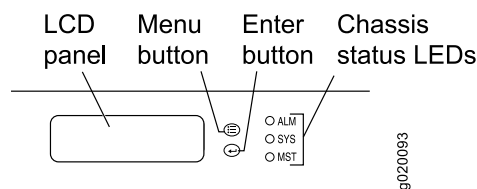

[Table 5 on page 16](#) describes the chassis status LEDs in an EX3300 switch, their colors and states, and the status they indicate.

Table 5: Chassis Status LEDs in an EX3300 Switch

LED Label	Color	State and Description
ALM (Alarm)	Unlit	There is no alarm or the switch is halted.
	Red	There is a major alarm. NOTE: When you connect power to the switch, the Alarm (ALM) LED lights red. This behavior is normal. Plugging an active Ethernet cable into the management (MGMT) port on the switch completes the network link and turns off the ALM LED. (See “ Connecting an EX Series Switch to a Network for Out-of-Band Management ” on page 106.) Connecting the switch to a dedicated management console instead of a network does not affect the ALM LED. The LED remains red until the switch is connected to a network.
	Amber	There is a minor alarm. NOTE: The Alarm (ALM) LED lights amber if you commit a configuration to make it active on the switch and do not also create a rescue configuration to back it up. To save the most recently committed configuration as the rescue configuration, enter the operational mode command <code>request system configuration rescue save</code> .
SYS (System)	Green	<ul style="list-style-type: none"> On steadily—Junos OS for EX Series switches has been loaded on the switch. Blinking—The switch is booting. Off—The switch is powered off or is halted.

Table 5: Chassis Status LEDs in an EX3300 Switch (*continued*)

LED Label	Color	State and Description
MST (Master)	Green	<p>In a standalone EX3300 switch:</p> <ul style="list-style-type: none"> On steadily—The switch is functioning normally. Off—The switch is powered off or is halted. <p>In a Virtual chassis configuration:</p> <ul style="list-style-type: none"> On steadily—The switch is the master in the Virtual Chassis configuration. Blinking—The switch is the backup in the Virtual Chassis configuration. Off—The switch is a linecard member in the Virtual Chassis configuration or is halted.

A major alarm (red) indicates a critical error condition that requires immediate action.

A minor alarm (amber) indicates a noncritical condition that requires monitoring or maintenance. A minor alarm that is left unchecked might cause interruption in service or performance degradation.

All three LEDs can be lit simultaneously.

Related Documentation

- [Front Panel of an EX3300 Switch on page 6](#)
- [Checking Active Alarms with the J-Web Interface](#)
- [Understanding Alarm Types and Severity Levels on EX Series Switches](#)

Network Port and Uplink Port LEDs in EX3300 Switches

Each network port and uplink port on the front panel of an EX3300 switch has two LEDs that indicate link/activity and port status. See [Figure 7 on page 17](#) and [Figure 8 on page 18](#).

Figure 7: LEDs on the Network Ports on the Front Panel

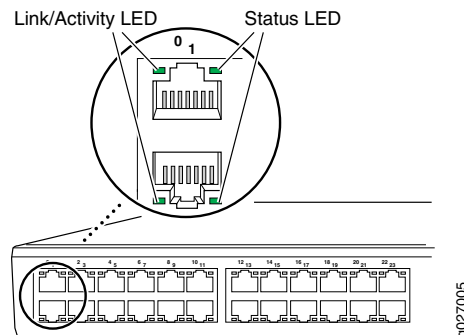

Figure 8: LEDs on the Uplink Ports

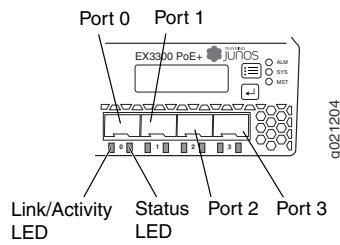

Table 6 on page 18 describes the Link/Activity LED.

Table 6: Link/Activity LED on the Network Ports and Uplink Ports in EX3300 Switches

LED	Color	State and Description
Link/Activity	Green	<ul style="list-style-type: none"> Blinking—The port and the link are active, and there is link activity. On steadily—The port and the link are active, but there is no link activity. Off—The port is not active.

The LEDs labeled Status LED in Figure 7 on page 17 and Figure 8 on page 18 indicate the status of one of the four port parameters—speed, administrative status, duplex mode, and Power over Ethernet Plus (PoE+) status. From the Idle menu of the LCD, use the **Enter** button on the LCD panel to toggle between the SPD, ADM, DPX, and POE, indicators.

Table 7 on page 19 describes the Status LED on the network ports and table describes the Status LED on the uplink ports.

Table 7: Status LED on the Network Ports in EX3300 Switches

LED	LCD Indicator	State and Description
Status	LED: SPD	Indicates the speed. The status indicators are: <ul style="list-style-type: none"> • Unlit—10 Mbps • Blinking—100 Mbps • On steadily—1000 Mbps
	LED: ADM	Indicates the administrative status. The status indicators are: <ul style="list-style-type: none"> • On steadily—Port is administratively enabled. • Off—Port is administratively disabled.
	LED: DPX	Indicates the duplex mode. The status indicators are: <ul style="list-style-type: none"> • Green—Port is set to full-duplex mode. • Unlit—Port is set to half-duplex mode.
	LED: POE	Indicates the PoE status. The status indicators are: <ul style="list-style-type: none"> • On steadily—PoE is available on the port. • Blinking—PoE is available on the port, but no power is drawn from the port because of one of the following: <ul style="list-style-type: none"> • No device that draws power from the port is connected to the port. • A device that draws power from the port is connected to the port, but the device is not drawing any power from the port. • Unlit—PoE is not enabled on the port.

Table 8: Status LED on the Uplink Ports in EX3300 Switches

LED	LCD Indicator	State and Description
Status	LED: SPD	Indicates the speed. The status indicators are: <ul style="list-style-type: none"> • Unlit—10/100 Mbps • Blinking—1000 Mbps • On steadily—10 Gbps
	LED: ADM	Indicates the administrative status. The status indicators are: <ul style="list-style-type: none"> • On steadily—Port is administratively enabled. • Off—Port is administratively disabled.
	LED: DPX	Indicates the duplex mode. The uplink ports are always set to full-duplex; therefore, the LED for uplink ports is always green.
	LED: POE	Indicates the PoE status. PoE is not enabled on uplink ports; therefore, the LED for uplink ports is always unlit.

Related Documentation

- [Front Panel of an EX3300 Switch on page 6](#)
- [Configuring Gigabit Ethernet Interfaces \(CLI Procedure\)](#)
- [Configuring Gigabit Ethernet Interfaces \(J-Web Procedure\)](#)

Management Port LEDs in EX3300 Switches

The management port on the rear panel of an EX3300 switch has two LEDs that indicate link/activity and port status (see [Figure 9 on page 20](#)).

Figure 9: LEDs on the Management Port on an EX3300 Switch

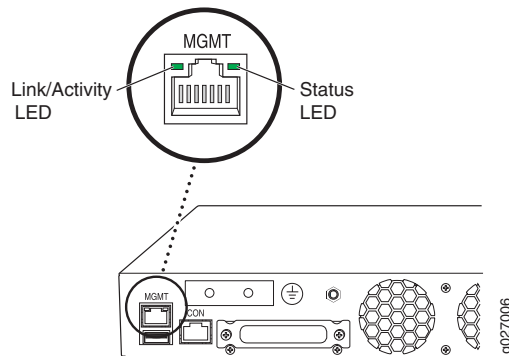

[Table 9 on page 21](#) describes the Link/Activity LED.

Table 9: Link/Activity LED on the Management Port on an EX3300 Switch

LED	Color	State and Description
Link/Activity	Green	<ul style="list-style-type: none"> Blinking—The port and the link are active, and there is link activity. On steadily—The port and the link are active, but there is no link activity. Off—The port is not active.

Table 10 on page 21 describes the Status LED.

Table 10: Status LED on the Management Port on an EX3300 Switch

LED	LCD Indicator	State and Description
Status	SPD	<p>Indicates the speed. The speed indicators are:</p> <ul style="list-style-type: none"> One blink per second—10 Mbps Two blinks per second—100 Mbps Three blinks per second—1000 Mbps

Related Documentation • [Connecting an EX Series Switch to a Network for Out-of-Band Management on page 106](#)

Power Supply in EX3300 Switches

The power supply in EX3300 switches is built in along the rear panel of the chassis, with an AC power cord inlet or DC power terminal block on the rear panel to connect power to the switch.



NOTE: After powering on the switch, wait for at least 60 seconds before powering it off. After powering off the switch, wait for at least 60 seconds before powering it back on.

After the switch has been powered on, it can take up to 60 seconds for status indicators—such as `show chassis` command output and messages on the LCD panel—to indicate that the power supply is functioning normally. Ignore error indicators that appear during the first 60 seconds.

Table 11 on page 21 lists the power consumed by each EX3300 switch model. The maximum power available on a PoE+ port is 15.4 W.

Table 11: Power Consumed by EX3300 Switches

Model Number	Number of PoE-Enabled Ports	Maximum Power Consumed by the Switch	Maximum System Power Available for PoE
EX3300-24T	–	50 W	–

Table 11: Power Consumed by EX3300 Switches (*continued*)

Model Number	Number of PoE-Enabled Ports	Maximum Power Consumed by the Switch	Maximum System Power Available for PoE
EX3300-24P	24	60 W (when no PoE power is drawn)	405 W
EX3300-24T-DC	–	50 W	–
EX3300-48T	–	76 W	–
EX3300-48T-BF	–	76 W	–
EX3300-48P	48	91 W (when no PoE power is drawn)	740 W

Related Documentation

- [AC Power Cord Specifications for EX3300 Switches on page 70](#)
- [Rear Panel of an EX3300 Switch on page 7](#)
- [Power Specifications for EX3300 Switches on page 69](#)
- [Connecting AC Power to an EX3300 Switch on page 102](#)
- [Connecting DC Power to an EX3300 Switch on page 103](#)
- [Connecting Earth Ground to an EX Series Switch on page 97](#)

Cooling System and Airflow in an EX3300 Switch

The cooling system in an EX3300 switch consists of two fans: one along the rear of the chassis and another along the left side of the chassis. The fans provide front-to-back or back-to-front chassis cooling depending on the switch model. [Table 12 on page 22](#) shows the different EX3300 switch models and their direction of airflow.

Table 12: Airflow Direction in EX3300 Switch Models

Model	Direction of Airflow
EX3300-24T	Front-to-back
EX3300-24P	Front-to-back
EX3300-24T-DC	Front-to-back
EX3300-48T	Front-to-back
EX3300-48T-BF	Back-to-front
EX3300-48P	Front-to-back

In front-to-back airflow models, the air intake is located on the front of the chassis. Cool air is pulled into the chassis and pushed toward the rear of the chassis. Hot air exhausts from the rear of the chassis. See [Figure 10 on page 23](#).

Figure 10: Front-to-Back Airflow Through the EX3300 Switch Chassis

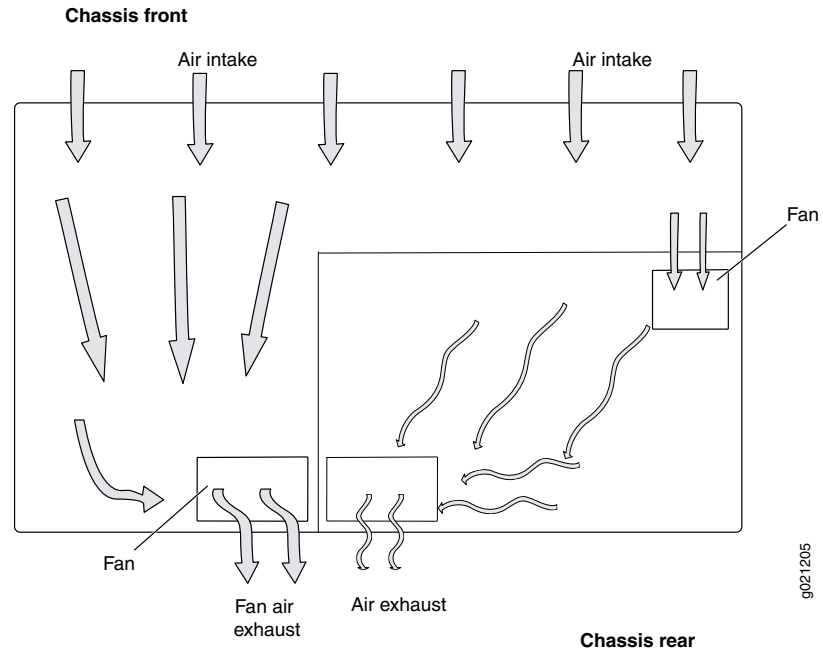

In back-to-front airflow models, the air intake is located on the rear of the chassis. Cool air is pulled into the chassis and pushed toward the front of the chassis. Hot air exhausts from the front of the chassis. See [Figure 11 on page 24](#).

Figure 11: Back-to-Front Airflow Through the EX3300 Switch Chassis

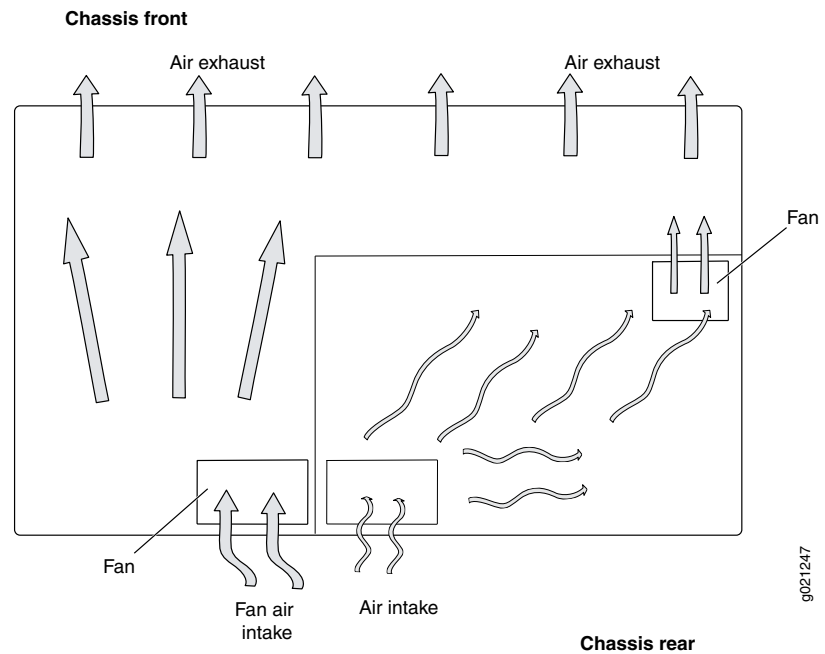

Under normal operating conditions, the fans operate at moderate speeds for minimal noise. Temperature sensors in the chassis monitor the temperature within the chassis. If any fan fails or if the temperature inside the chassis rises above the threshold, the switch raises an alarm and all functioning fans operate at a higher speed than normal. If the temperature inside the chassis rises above the threshold, the switch shuts down automatically.

Related Documentation

- [Rear Panel of an EX3300 Switch on page 7](#)
- [Chassis Status LEDs in EX3300 Switches on page 16](#)
- [Understanding Alarm Types and Severity Levels on EX Series Switches](#)
- [Prevention of Electrostatic Discharge Damage on page 170](#)

CHAPTER 3

Component Specifications

- [USB Port Specifications for an EX Series Switch on page 25](#)
- [Network Port Connector Pinout Information for an EX3300 Switch on page 26](#)
- [Console Port Connector Pinout Information for an EX Series Switch on page 27](#)
- [RJ-45 to DB-9 Serial Port Adapter Pinout Information for an EX Series Switch on page 28](#)
- [Management Port Connector Pinout Information for an EX3300 Switch on page 29](#)
- [Optical Interface Support in EX3300 Switches on page 30](#)
- [SFP+ Direct Attach Cables for EX Series Switches on page 46](#)

USB Port Specifications for an EX Series Switch

The following Juniper Networks USB flash drives have been tested and are officially supported for the USB port on all EX Series switches:

- RE-USB-1G-S
- RE-USB-2G-S
- RE-USB-4G-S



CAUTION: Any USB memory product not listed as supported for EX Series switches has not been tested by Juniper Networks. The use of any unsupported USB memory product could expose your EX Series switch to unpredictable behavior. Juniper Networks Technical Assistance Center (JTAC) can provide only limited support for issues related to unsupported hardware. We strongly recommend that you use only supported USB flash drives.

All USB flash drives used on EX Series switches must have the following features:

- USB 2.0 or later.
- Formatted with a FAT or MS-DOS file system.
- If the switch is running Junos OS Release 9.5 or earlier, the formatting method must use a master boot record. Microsoft Windows formatting, by default, does not use a master boot record. See the documentation for your USB flash drive for information about how your USB flash drive is formatted.

- Related Documentation**
- See EX2200 Switches Hardware Overview for port location.
 - See Rear Panel of an EX3200 Switch for port location.
 - See [Rear Panel of an EX3300 Switch on page 7](#) for port location.
 - See Rear Panel of an EX4200 Switch for port location.
 - See Front Panel of an EX4500 Switch for port location.
 - See Switch Fabric and Routing Engine (SRE) Module in an EX6200 Switch for port location.
 - See Switch Fabric and Routing Engine (SRE) Module in an EX8208 Switch for port location.
 - See Routing Engine (RE) Module in an EX8216 Switch for port location.
 - Booting an EX Series Switch Using a Software Package Stored on a USB Flash Drive

Network Port Connector Pinout Information for an EX3300 Switch

A network port on the switch uses an RJ-45 connector to connect to a device.

The port uses an autosensing RJ-45 connector to support a 10/100/1000BASE-T connection.

[Table 13 on page 26](#) provides the pinout information for a network port on an EX3300 switch.

Table 13: Network Port Connector Pinout Information for EX3300 Switches

Pin	Signal	Description
1	TRP1+	Transmit/receive data pair 1 Negative Vport (in PoE models)
2	TRP1-	Transmit/receive data pair 1 Negative Vport (in PoE models)
3	TRP2+	Transmit/receive data pair 2 Positive Vport (in PoE models)
4	TRP3+	Transmit/receive data pair 3
5	TRP3-	Transmit/receive data pair 3
6	TRP2-	Transmit/receive data pair 2 Positive Vport (in PoE models)
7	TRP4+	Transmit/receive data pair 4

Table 13: Network Port Connector Pinout Information for EX3300 Switches (*continued*)

Pin	Signal	Description
8	TRP4-	Transmit/receive data pair 4

- Related Documentation**
- [Front Panel of an EX3300 Switch on page 6](#)
 - [Network Port and Uplink Port LEDs in EX3300 Switches on page 17](#)

Console Port Connector Pinout Information for an EX Series Switch

The console port on an EX Series switch is an RS-232 serial interface that uses an RJ-45 connector to connect to a console management device. The default baud rate for the console port is 9600 baud.

[Table 14 on page 27](#) provides the pinout information for the RJ-45 console connector. An RJ-45 cable and an RJ-45 to DB-9 serial port adapter are supplied with the switch.



NOTE: If your laptop or PC does not have a DB-9 male connector pin and you want to connect your laptop or PC directly to an EX Series switch, use a combination of the RJ-45 to DB-9 female adapter supplied with the switch and a USB to DB-9 male adapter. You must provide the USB to DB-9 male adapter.

Table 14: EX Series Switches Console Port Connector Pinout Information

Pin	Signal	Description
1	RTS Output	Request to send
2	DTR Output	Data terminal ready
3	TxD Output	Transmit data
4	Signal Ground	Signal ground
5	Signal Ground	Signal ground
6	RxD Input	Receive data
7	CD Input	Data carrier detect
8	CTS Input	Clear to send

- Related Documentation**
- See [EX2200 Switches Hardware Overview](#) for port location.
 - See [Rear Panel of an EX3200 Switch](#) for port location.

- See [Rear Panel of an EX3300 Switch on page 7](#) for port location.
- See Rear Panel of an EX4200 Switch for port location.
- See Front Panel of an EX4500 Switch for port location.
- See Switch Fabric and Routing Engine (SRE) Module in an EX6200 Switch for port location.
- See Switch Fabric and Routing Engine (SRE) Module in an EX8208 Switch for port location.
- See Routing Engine (RE) Module in an EX8216 Switch for port location.
- [Connecting an EX Series Switch to a Management Console on page 107](#)
- [Configuring the Console Port Type \(CLI Procedure\)](#)

RJ-45 to DB-9 Serial Port Adapter Pinout Information for an EX Series Switch

The console port on an EX Series switch is an RS-232 serial interface that uses an RJ-45 connector to connect to a management device such as a PC or a laptop. If your laptop or PC does not have a DB-9 male connector pin and you want to connect your laptop or PC to an EX Series switch, use a combination of the RJ-45 to DB-9 female adapter supplied with the switch along with a USB to DB-9 male adapter.

[Table 15 on page 28](#) provides the pinout information for the RJ-45 to DB-9 serial port adapter.

Table 15: EX Series Switches RJ-45 to DB-9 Serial Port Adapter Pinout Information

RJ-45 Pin	Signal	DB-9 Pin	Signal
1	RTS	8	CTS
2	DTR	6	DSR
3	TXD	2	RXD
4	GND	5	GND
6	RXD	3	TXD
7	DSR	4	DTR
8	CTS	7	RTS

Related Documentation

- [Connecting an EX Series Switch to a Management Console on page 107](#)
- [Connecting and Configuring an EX Series Switch \(CLI Procedure\) on page 118](#)

Management Port Connector Pinout Information for an EX3300 Switch

The management port on an EX3300 switch uses an RJ-45 connector to connect to a management device for out-of-band management.

The port uses an autosensing RJ-45 connector to support a 10/100BASE-T connection. Two LEDs on the port indicate link/activity on the port and the administrative status of the port. See [“Management Port LEDs in EX3300 Switches” on page 20](#).

[Table 16 on page 29](#) provides the pinout information for the RJ-45 connector for the management port. An Ethernet cable, with an RJ-45 connector attached, is supplied with the switch.

Table 16: Management Port Connector Pinout Information for EX3300 Switches

Pin	Signal	Description
1	TRP1+	Transmit/receive data pair 1
2	TRP1-	Transmit/receive data pair 1
3	TRP2+	Transmit/receive data pair 2
4	TRP3+	Transmit/receive data pair 3
	This pin is used only when the port is operating at 1000 Mbps.	
5	TRP3-	Transmit/receive data pair 3
	This pin is used only when the port is operating at 1000 Mbps.	
6	TRP2-	Transmit/receive data pair 2
7	TRP4+	Transmit/receive data pair 4
	This pin is used only when the port is operating at 1000 Mbps.	
8	TRP4-	Transmit/receive data pair 4
	This pin is used only when the port is operating at 1000 Mbps.	

- Related Documentation**
- See [Rear Panel of an EX3300 Switch on page 7](#) for port location.
 - [Connecting an EX Series Switch to a Network for Out-of-Band Management on page 106](#)

Optical Interface Support in EX3300 Switches

Uplink ports on the front panel in EX3300 switches support SFP and SFP+ transceivers. This topic describes the optical interfaces supported for those transceivers.



NOTE: Use only optical transceivers and optical connectors purchased from Juniper Networks for your EX Series switches.

The Gigabit Ethernet SFP and SFP+ transceivers installed in EX3300 switches support digital optical monitoring (DOM): you can view the diagnostic details for these transceivers by issuing the operational mode CLI command **show interfaces diagnostics optics**.



NOTE: The transceivers support DOM even if they are installed in uplink ports configured as Virtual Chassis ports.

The tables in this topic describe the optical interface support over single-mode fiber-optic (SMF) and multimode fiber-optic (MMF) cables for SFP and SFP+ transceivers:

- [Table 17 on page 31](#)—Optical interface support for Gigabit Ethernet SFP transceivers.
- [Table 18 on page 42](#)—Optical interface support for Gigabit Ethernet SFP+ transceivers.

Table 17: Optical Interface Support for Gigabit Ethernet SFP Transceivers

Ethernet Standard	Specification	Value			
1000BASE-SX	Model Number	EX-SFP-1GE-SX			
	Rate	1000 Mbps			
	Connector Type	LC			
	Fiber Count	Dual			
	Transmitter Wavelength	850 nm			
	Minimum Launch Power	−9.5 dBm			
	Maximum Launch Power	−3 dBm			
	Minimum Receiver Sensitivity	−21 dBm			
	Maximum Input Power	0 dBm			
	Fiber Type	MMF			
	Core/Cladding Size	62.5/125 μm	62.5/125 μm	50/125 μm	50/125 μm
	Fiber Grade	FDDI	OM1	–	OM2
	Modal Bandwidth	160 MHz/km	200 MHz/km	400 MHz/km	500 MHz/km
	Distance	220 m (722 ft)	275 m (902 ft)	500 m (1640 ft)	550 m (1804 ft)
	DOM Support	Available			
	Software Required	Junos OS for EX Series switches, Release 11.3 or later			

Table 17: Optical Interface Support for Gigabit Ethernet SFP Transceivers (*continued*)

Ethernet Standard	Specification	Value
1000BASE-LX	Model Number	EX-SFP-1GE-LX
	Rate	1000 Mbps
	Connector Type	LC
	Fiber Count	Dual
	Transmitter Wavelength	1310 nm
	Minimum Launch Power	-9.5 dBm
	Maximum Launch Power	-3 dBm
	Minimum Receiver Sensitivity	-25 dBm
	Maximum Input Power	-3 dBm
	Fiber Type	SMF
	Core/Cladding Size	9/125 μ m
	Modal Bandwidth	-
	Distance	10 km (6.2 miles)
	DOM Support	Available
	Software Required	Junos OS for EX Series switches, Release 11.3 or later

Table 17: Optical Interface Support for Gigabit Ethernet SFP Transceivers (*continued*)

Ethernet Standard	Specification	Value
1000BASE-T	Model Number	EX-SFP-1GE-T
	Rate	10/100/1000 Mbps
	Connector Type	RJ-45
	Fiber Count	Copper
	Transmitter Wavelength	–
	Minimum Launch Power	–
	Maximum Launch Power	–
	Minimum Receiver Sensitivity	–
	Maximum Input Power	–
	Fiber Type	Copper
	Core/Cladding Size	–
	Modal Bandwidth	–
	Distance	100 m (328 ft)
	DOM Support	Not available
	Software Required	Junos OS for EX Series switches, Release 12.1 or later

Table 17: Optical Interface Support for Gigabit Ethernet SFP Transceivers (*continued*)

Ethernet Standard	Specification	Value
1000BASE-BX-U	Model Number	EX-SFP-GE10KT13R14
	Rate	1000 Mbps
	Connector Type	LC
	Fiber Count	Single
	Transmitter Wavelength	1310 nm
	Receiver Wavelength	1490 nm
	Minimum Launch Power	-9 dBm
	Maximum Launch Power	-3 dBm
	Minimum Receiver Sensitivity	-30 dBm
	Maximum Input Power	-3 dBm
	Fiber Type	SMF
	Core/Cladding Size	9/125 μ m
	Modal Bandwidth	-
	Distance	10 km (6.2 miles)
	DOM Support	Available
	Software Required	Junos OS for EX Series switches, Release 12.1 or later

Table 17: Optical Interface Support for Gigabit Ethernet SFP Transceivers (*continued*)

Ethernet Standard	Specification	Value
1000BASE-BX-D	Model Number	EX-SFP-GE10KT14R13
	Rate	1000 Mbps
	Connector Type	LC
	Fiber Count	Single
	Transmitter Wavelength	1490 nm
	Receiver Wavelength	1310 nm
	Minimum Launch Power	-9 dBm
	Maximum Launch Power	-3 dBm
	Minimum Receiver Sensitivity	-30 dBm
	Maximum Input Power	-3 dBm
	Fiber Type	SMF
	Core/Cladding Size	9/125 μ m
	Modal Bandwidth	-
	Distance	10 km (6.2 miles)
	DOM Support	Available
	Software Required	Junos OS for EX Series switches, Release 12.1 or later

Table 17: Optical Interface Support for Gigabit Ethernet SFP Transceivers (*continued*)

Ethernet Standard	Specification	Value
1000BASE-BX-U	Model Number	EX-SFP-GE10KT13R15
	Rate	1000 Mbps
	Connector Type	LC
	Fiber Count	Single
	Transmitter Wavelength	1310 nm
	Receiver Wavelength	1550 nm
	Minimum Launch Power	-9 dBm
	Maximum Launch Power	-3 dBm
	Minimum Receiver Sensitivity	-21 dBm
	Maximum Input Power	-3 dBm
	Fiber Type	SMF
	Core/Cladding Size	9/125 μ m
	Modal Bandwidth	-
	Distance	10 km (6.2 miles)
	DOM Support	Available
	Software Required	Junos OS for EX Series switches, Release 12.1 or later

Table 17: Optical Interface Support for Gigabit Ethernet SFP Transceivers (*continued*)

Ethernet Standard	Specification	Value
1000BASE-BX-D	Model Number	EX-SFP-GE10KT15R13
	Rate	1000 Mbps
	Connector Type	LC
	Fiber Count	Single
	Transmitter Wavelength	1550 nm
	Receiver Wavelength	1310 nm
	Minimum Launch Power	-9 dBm
	Maximum Launch Power	-3 dBm
	Minimum Receiver Sensitivity	-21 dBm
	Maximum Input Power	-3 dBm
	Fiber Type	SMF
	Core/Cladding Size	9/125 μ m
	Modal Bandwidth	-
	Distance	10 km (6.2 miles)
	DOM Support	Available
	Software Required	Junos OS for EX Series switches, Release 12.1 or later

Table 17: Optical Interface Support for Gigabit Ethernet SFP Transceivers (*continued*)

Ethernet Standard	Specification	Value
1000BASE-BX-U	Model Number	EX-SFP-GE40KT13R15
	Rate	1000 Mbps
	Connector Type	LC
	Fiber Count	Single
	Transmitter Wavelength	1310 nm
	Receiver Wavelength	1550 nm
	Minimum Launch Power	-6.5 dBm
	Maximum Launch Power	2 dBm
	Minimum Receiver Sensitivity	-23 dBm
	Maximum Input Power	-3 dBm
	Fiber Type	SMF
	Core/Cladding Size	9/125 μ m
	Modal Bandwidth	-
	Distance	40 km (24.8 miles)
	DOM Support	Available
	Software Required	Junos OS for EX Series switches, Release 12.1 or later

Table 17: Optical Interface Support for Gigabit Ethernet SFP Transceivers (*continued*)

Ethernet Standard	Specification	Value
1000BASE-BX-D	Model Number	EX-SFP-GE40KT15R13
	Rate	1000 Mbps
	Connector Type	LC
	Fiber Count	Single
	Transmitter Wavelength	1550 nm
	Receiver Wavelength	1310 nm
	Minimum Launch Power	-6.5 dBm
	Maximum Launch Power	2 dBm
	Minimum Receiver Sensitivity	-23 dBm
	Maximum Input Power	-3 dBm
	Fiber Type	SMF
	Core/Cladding Size	9/125 μ m
	Modal Bandwidth	-
	Distance	40 km (24.8 miles)
	DOM Support	Available
	Software Required	Junos OS for EX Series switches, Release 12.1 or later

Table 17: Optical Interface Support for Gigabit Ethernet SFP Transceivers (*continued*)

Ethernet Standard	Specification	Value
1000BASE-LX	Model Number	EX-SFP-1GE-LX40K
	Rate	1000 Mbps
	Connector Type	LC
	Fiber Count	Double
	Transmitter Wavelength	1310 nm
	Minimum Launch Power	-14 dBm
	Maximum Launch Power	-8 dBm
	Minimum Receiver Sensitivity	-45 dBm
	Maximum Input Power	-3 dBm
	Fiber Type	SMF
	Core/Cladding Size	9/125 μ m
	Modal Bandwidth	-
	Distance	40 km (24.8 miles)
	DOM Support	Available
	Software Required	Junos OS for EX Series switches, Release 12.1 or later

Table 17: Optical Interface Support for Gigabit Ethernet SFP Transceivers (*continued*)

Ethernet Standard	Specification	Value
1000BASE-LH (or 1000BASE-ZX)	Model Number	EX-SFP-1GE-LH
	Rate	1000 Mbps
	Connector Type	LC
	Fiber Count	Dual
	Transmitter Wavelength	1550 nm
	Minimum Launch Power	-2 dBm
	Maximum Launch Power	5 dBm
	Minimum Receiver Sensitivity	-25 dBm
	Maximum Input Power	-3 dBm
	Fiber Type	SMF
	Core/Cladding Size	9/125 μ m
	Modal Bandwidth	-
	Distance	70 km (43.5 miles)
	DOM Support	Available
	Software Required	Junos OS for EX Series switches, Release 12.1 or later

Table 18: Optical Interface Support for SFP+ Gigabit Ethernet Transceivers

Ethernet Standard	Specification	Value			
10GbE USR <i>NOTE:</i> This is not an IEEE standard.	Model Number	EX-SFP-10GE-USR			
	Rate	10 Gbps			
	Connector Type	LC			
	Fiber Count	Dual			
	Transmitter Wavelength	850 nm			
	Minimum Launch Power	-7.3 dBm			
	Maximum Launch Power	-1.3 dBm			
	Minimum Receiver Sensitivity	-11.1 dBm			
	Maximum Input Power	-1.0 dBm			
	Fiber Type	MMF			
	Core/Cladding Size	62.5/125 μm	50/125 μm	50/125 μm	
	Fiber Grade	OM1	OM3	OM3	
	Modal Bandwidth	200 MHz/km	500 MHz/km	1500 MHz/km	
	Distance	10 m (32.8 ft)	30 m (98.4 ft)	100 m (328 ft)	
	DOM Support	Available			
	Software Required	Junos OS for EX Series switches, Release 11.3 or later			

Table 18: Optical Interface Support for SFP+ Gigabit Ethernet Transceivers (*continued*)

Ethernet Standard	Specification	Value				
10GBASE-SR	Model Number	EX-SFP-10GE-SR				
	Rate	10 Gbps				
	Connector Type	LC				
	Fiber Count	Dual				
	Transmitter Wavelength	850 nm				
	Minimum Launch Power	-7.3 dBm				
	Maximum Launch Power	-1 dBm				
	Minimum Receiver Sensitivity	-9.9 dBm				
	Maximum Input Power	-1 dBm				
	Fiber Type	MMF				
	Core/Cladding Size	62.5/125 μ m	62.5/125 μ m	50/125 μ m	50/125 μ m	50/125 μ m
	Fiber Grade	FDDI	OM1	-	OM2	OM3
	Modal Bandwidth	160 MHz/km	200 MHz/km	400 MHz/km	500 MHz/km	1500 MHz/km
	Distance	26 m (85 ft)	33 m (108 ft)	66 m (216 ft)	82 m (269 ft)	300 m (984 ft)
	DOM Support	Available				
Software required	Junos OS for EX Series switches, Release 11.3 or later					

Table 18: Optical Interface Support for SFP+ Gigabit Ethernet Transceivers (*continued*)

Ethernet Standard	Specification	Value		
10GBASE-LRM	Model Number	EX-SFP-10GE-LRM		
	Rate	10 Gbps		
	Connector Type	LC		
	Fiber Count	Dual		
	Transmitter Wavelength	1310 nm		
	Minimum Launch Power	-6.5 dBm		
	Maximum Launch Power	0.5 dBm		
	Minimum Receiver Sensitivity	-21 dBm		
	Maximum Input Power	0.5 dBm		
	Fiber Type	MMF		
	Core/Cladding Size	625/125µm	50/125µm	50/125µm
	Fiber Grade	FDDI/OM1	OM2	OM3
	Modal Bandwidth	500 MHz/km	500 MHz/km	500 MHz/km
	Distance	220 m (722 ft)	220 m (722 ft)	220 m (722 ft)
	DOM Support	Available		
	Software required	Junos OS for EX Series switches, Release 11.3 or later		

Table 18: Optical Interface Support for SFP+ Gigabit Ethernet Transceivers (*continued*)

Ethernet Standard	Specification	Value
10GBASE-LR	Model Number	EX-SFP-10GE-LR
	Rate	10 Gbps
	Connector Type	LC
	Fiber Count	Dual
	Transmitter Wavelength	1310 nm
	Minimum Launch Power	-8.2 dBm
	Maximum Launch Power	0.5 dBm
	Minimum Receiver Sensitivity	-18 dBm
	Maximum Input Power	0.5 dBm
	Fiber Type	SMF
	Core/Cladding Size	9/125 μ m
	Modal Bandwidth	-
	Distance	10 km (6.2 miles)
	DOM Support	Available
	Software required	Junos OS for EX Series switches, Release 11.3 or later

Table 18: Optical Interface Support for SFP+ Gigabit Ethernet Transceivers (*continued*)

Ethernet Standard	Specification	Value
10GBASE-ER	Model Number	EX-SFP-10GE-ER
	Rate	10 Gbps
	Connector Type	LC
	Fiber Count	Dual
	Transmitter Wavelength	1550 nm
	Minimum Launch Power	-4.7 dBm
	Maximum Launch Power	4 dBm
	Minimum Receiver Sensitivity	-11.3 dBm
	Maximum Input Power	-1 dBm
	Fiber Type	SMF
	Core/Cladding Size	9/125 μ m
	Modal Bandwidth	-
	Distance	40 km (24.8 miles)
	DOM Support	Available
	Software Required	Junos OS for EX Series switches, Release 12.1 or later

- Related Documentation**
- [Front Panel of an EX3300 Switch on page 6](#)
 - [Installing a Transceiver in an EX Series Switch on page 93](#)
 - [Removing a Transceiver from an EX Series Switch on page 127](#)

SFP+ Direct Attach Cables for EX Series Switches

Small form-factor pluggable plus transceiver (SFP+) direct attach copper cables, also known as Twinax cables, are suitable for in-rack connections between servers and switches. They are suitable for short distances up to 23 ft (7 m), making them ideal for highly cost-effective networking connectivity within a rack and between adjacent racks.

This topic describes:

- [Cable Specifications on page 47](#)
- [Standards Supported by These Cables on page 50](#)

Cable Specifications

EX Series switches support SFP+ passive direct attach cables. The passive Twinax cable is a straight cable with no active electronic components. EX Series switches support 1 m, 3 m, 5 m, and 7 m long SFP+ passive direct attach cables.

[Table 19 on page 47](#) describes the support for SFP+ passive direct attach cable lengths on EX Series switches for Junos OS releases:

Table 19: Software Support for SFP+ Passive Direct Attach Cables for EX Series Switches

Switch	Software Support Added	Cable Length
EX3200 switches	Junos OS Release 10.3	1 m, 3 m, 5 m, and 7 m
EX3300 switches	Junos OS Release 11.3	1 m and 7 m
EX4200 switches	Junos OS Release 10.3	1 m, 3 m, 5 m, and 7 m
EX4500 switches	Junos OS Release 10.2	1 m, 3 m, and 7 m
	Junos OS Release 11.2	5 m
EX8200 8-port SFP+ line cards (EX8200-8XS)	Junos OS Release 10.0	1 m, 3 m, and 7 m
	Junos OS Release 10.3	5 m
EX8200 40-port SFP+ line cards (EX8200-40XS)	Junos OS Release 10.3	1 m, 3 m, and 7 m
	Junos OS Release 11.1	5 m



NOTE: We recommend that you use only Juniper Networks SFP+ direct attach cables with your EX Series switches.

The cables are hot-removable and hot-insertable: You can remove and replace them without powering off the switch or disrupting switch functions. A cable comprises a low-voltage cable assembly that connects directly into two SFP+ ports, one at each end of the cable. The cables use high-performance integrated duplex serial data links for bidirectional communication and are designed for data rates up to 10 Gbps.

[Table 20 on page 48](#) describes the cable specifications.

Table 20: SFP+ Direct Attach Cable Specifications

Model	Specification	Value
EX-SFP-10GE-DAC-1m	Rate	10 Gbps full-duplex serial transmission
	Connector type	SFP+ passive Twinax cable assembly
	Supply voltage	3.3 V
	Power consumption (per end)	0.57 W
	Storage temperature	-40°C through 85°C
	Cable type	Twinax
	Wire AWG	30 AWG
	Minimum cable bend radius	1 in.
	Cable characteristic impedance	100 ohms
	Crosstalk between pairs	2% maximum
	Time delay	1.31 nsec/ft
	Length	3.3 ft (1 m)
	EX-SFP-10GE-DAC-3m	Rate
Connector type		SFP+ passive Twinax cable assembly
Supply voltage		3.3 V
Power consumption (per end)		0.57 W
Storage temperature		-40°C through 85°C
Cable type		Twinax
Wire AWG		30 AWG
Minimum cable bend radius		1 in.
Cable characteristic impedance		100 ohms
Crosstalk between pairs		2% maximum
Time delay		1.31 nsec/ft
Length		9.9 ft (3 m)

Table 20: SFP+ Direct Attach Cable Specifications (*continued*)

Model	Specification	Value
EX-SFP-10GE-DAC-5m	Rate	10 Gbps full-duplex serial transmission
	Connector type	SFP+ passive Twinax cable assembly
	Supply voltage	3.3 V
	Power consumption (per end)	0.57 W
	Storage temperature	-40°C through 85°C
	Cable type	Twinax
	Wire AWG	24 AWG
	Minimum cable bend radius	1 in.
	Cable characteristic impedance	100 ohms
	Crosstalk between pairs	2% maximum
	Time delay	1.31 nsec/ft
	Length	16.4 ft (5 m)
	EX-SFP-10GE-DAC-7m	Rate
Connector type		SFP+ passive Twinax cable assembly
Supply voltage		3.3 V
Power consumption (per end)		0.57 W
Storage temperature		-40°C through 85°C
Cable type		Twinax
Wire AWG		24 AWG
Minimum cable bend radius		1 in.
Cable characteristic impedance		100 ohms
Crosstalk between pairs		2% maximum
Time delay		1.31 nsec/ft
Length		23 ft (7 m)

Standards Supported by These Cables

The cables comply with the following standards:

- SFP mechanical standard SFF-843—see <ftp://ftp.seagate.com/sff/SFF-8431.PDF>.
- Electrical interface standard SFF-8432—see <ftp://ftp.seagate.com/sff/SFF-8432.PDF>.
- SFP+ Multi-Source Alliance (MSA) standards

Related Documentation

- Optical Interface Support in EX3200 Switches
- [Optical Interface Support in EX3300 Switches on page 30](#)
- Optical Interface Support in EX4200 Switches
- Optical Interface Support in EX4500 Switches
- Optical Interface Support in EX8200 Switches
- [Installing a Transceiver in an EX Series Switch on page 93](#)
- [Removing a Transceiver from an EX Series Switch on page 127](#)

PART 2

Planning for Switch Installation

- [Site Preparation on page 53](#)
- [Mounting and Clearance Requirements on page 61](#)
- [Cable Specifications on page 67](#)
- [Planning Power Requirements on page 69](#)
- [Planning the Virtual Chassis on page 73](#)

CHAPTER 4

Site Preparation

- [Site Preparation Checklist for EX3300 Switches on page 53](#)
- [General Site Guidelines on page 54](#)
- [Site Electrical Wiring Guidelines on page 55](#)
- [Environmental Requirements and Specifications for EX Series Switches on page 57](#)

Site Preparation Checklist for EX3300 Switches

The checklist in [Table 21 on page 53](#) summarizes the tasks you need to perform when preparing a site for EX3300 switch installation.

Table 21: Site Preparation Checklist

Item or Task	For More Information	Performed By	Date
Environment			
Verify that environmental factors such as temperature and humidity do not exceed switch tolerances.	"Environmental Requirements and Specifications for EX Series Switches" on page 57		
Power			
Measure distance between external power sources and switch installation site.			
Locate sites for connection of system grounding.			
Calculate the power consumption and requirements.	"Power Specifications for EX3300 Switches" on page 69		
Hardware Configuration			
Choose the number and types of switches you want to install.	"EX3300 Switches Hardware Overview" on page 3		
Rack or Cabinet			

Table 21: Site Preparation Checklist (*continued*)

Item or Task	For More Information	Performed By	Date
Verify that your rack or cabinet meets the minimum requirements for the installation of the switch.	"Rack Requirements for EX3300 Switches" on page 61 "Cabinet Requirements for EX3300 Switches" on page 62		
Plan rack or cabinet location, including required space clearances.	"Clearance Requirements for Airflow and Hardware Maintenance for EX3300 Switches" on page 64		
Secure the rack or cabinet to the floor and building structure.			
Wall			
Verify that the wall meets the minimum requirements for the installation of the switch.	"Requirements for Mounting an EX3300 Switch on a Desktop or Wall" on page 63		
Verify that there is appropriate clearance in your selected location.	"Clearance Requirements for Airflow and Hardware Maintenance for EX3300 Switches" on page 64		
Cables			
Acquire cables and connectors:			
<ul style="list-style-type: none"> Determine the number of cables needed based on your planned configuration. Review the maximum distance allowed for each cable. Choose the length of cable based on the distance between the hardware components being connected. 			
Plan the cable routing and management.			

- Related Documentation**
- [General Safety Guidelines and Warnings on page 145](#)
 - [General Site Guidelines on page 54](#)
 - [Installing and Connecting an EX3300 Switch on page 79](#)
 - [Mounting an EX3300 Switch on page 82](#)

General Site Guidelines

This topic applies to hardware devices in the EX Series product family, which includes switches, the EX Series Redundant Power System (RPS), and the XRE200 External Routing Engine.

This topic also applies to hardware devices in the QFX Series.

Efficient device operation requires proper site planning and maintenance and proper layout of the equipment, rack or cabinet (if used), and wiring closet.

To plan and create an acceptable operating environment for your device and prevent environmentally caused equipment failures:

- Keep the area around the chassis free from dust and conductive material, such as metal flakes.
- Follow prescribed airflow guidelines to ensure that the cooling system functions properly and that exhaust from other equipment does not blow into the intake vents of the device.
- Follow the prescribed ESD prevention procedures to avoid damaging the equipment. Static discharge can cause components to fail completely or intermittently over time.
- Install the device in a secure area, so that only authorized personnel can access the device.

Related Documentation

- [Prevention of Electrostatic Discharge Damage on page 170](#)
- [Environmental Requirements and Specifications for EX Series Switches on page 57](#)
- Environmental Requirements and Specifications for a QFX3100 Director Device
- Environmental Requirements and Specifications for a QFX3008-I Interconnect Device
- Environmental Requirements and Specifications for a QFX3500 Device
- Environmental Requirements and Specifications for QFX3600 and QFX3600-I Devices

Site Electrical Wiring Guidelines

This topic applies to hardware devices in the EX Series product family, which includes switches, the EX Series Redundant Power System (RPS), and the XRE200 External Routing Engine.

This topic also applies to hardware devices in the QFX Series.

[Table 22 on page 56](#) describes the factors you must consider while planning the electrical wiring at your site.



WARNING: It is particularly important to provide a properly grounded and shielded environment and to use electrical surge-suppression devices.

Table 22: Site Electrical Wiring Guidelines

Site Wiring Factor	Guidelines
Signaling limitations	<p>If your site experiences any of the following problems, consult experts in electrical surge suppression and shielding:</p> <ul style="list-style-type: none"> • Improperly installed wires cause radio frequency interference (RFI). • Damage from lightning strikes occurs when wires exceed recommended distances or pass between buildings. • Electromagnetic pulses (EMPs) caused by lightning damage unshielded conductors and electronic devices.
Radio frequency interference	<p>To reduce or eliminate radio frequency interference (RFI) from your site wiring, do the following:</p> <ul style="list-style-type: none"> • Use a twisted-pair cable with a good distribution of grounding conductors. • If you must exceed the recommended distances, use a high-quality twisted-pair cable with one ground conductor for each data signal when applicable.
Electromagnetic compatibility	<p>If your site is susceptible to problems with electromagnetic compatibility (EMC), particularly from lightning or radio transmitters, seek expert advice.</p> <p>Some of the problems caused by strong sources of electromagnetic interference (EMI) are:</p> <ul style="list-style-type: none"> • Destruction of the signal drivers and receivers in the switch • Electrical hazards as a result of power surges conducted over the lines into the equipment

Related Documentation

- [General Safety Guidelines and Warnings on page 145](#)
- [General Electrical Safety Guidelines and Warnings on page 169](#)
- [Prevention of Electrostatic Discharge Damage on page 170](#)
- Power Supply in EX2200 Switches
- Power Supply in EX3200 Switches
- [Power Supply in EX3300 Switches on page 21](#)
- Power Supply in EX4200 Switches
- AC Power Supply in EX4500 Switches
- DC Power Supply in EX4500 Switches
- AC Power Supplies in an EX6200 Switch
- DC Power Supply in an EX6200 Switch
- AC Power Supply in an EX8200 Switch
- DC Power Supply in an EX8200 Switch
- Power Supply in an EX Series Redundant Power System
- AC Power Supply in a QFX3100 Director Device
- AC Power Supply in a QFX3008-I Interconnect Device
- Wiring Tray in a QFX3008-I Interconnect Device

- AC Power Supply for a QFX3500, QFX3600, or QFX3600-I Device
- DC Power Supply for a QFX3500, QFX3600, or QFX3600-I Device

Environmental Requirements and Specifications for EX Series Switches

The switch must be installed in a rack or cabinet housed in a dry, clean, well-ventilated, and temperature-controlled environment.

Ensure that these environmental guidelines are followed:

- The site must be as dust-free as possible, because dust can clog air intake vents and filters, reducing the efficiency of the switch cooling system.
- Maintain ambient airflow for normal switch operation. If the airflow is blocked or restricted, or if the intake air is too warm, the switch might overheat, leading to the switch temperature monitor shutting down the switch to protect the hardware components.

Table 23 on page 57 provides the required environmental conditions for normal switch operation.

Table 23: EX Series Switch Environmental Tolerances

Switch or device	Environment Tolerance			
	Altitude	Relative humidity	Temperature	Seismic
EX2200-C	No performance degradation up to 5,000 feet (1524 meters)	Normal operation ensured in relative humidity range of 10% through 85% (noncondensing)	Normal operation ensured in the temperature range 32° F through 104° F (0° C through 40° C) at altitudes up to 5,000 ft (1,524 m). For information about extended temperature SFPs, see Optical Interface Support in EX2200 Switches.	Complies with Zone 4 earthquake requirements as per GR-63, Issue 3.
EX2200 (except EX2200-C models)	No performance degradation up to 10,000 feet (3048 meters)	Normal operation ensured in relative humidity range of 10% through 85% (noncondensing)	Normal operation ensured in the temperature range 32° F through 113° F (0° C through 45° C)	Complies with Zone 4 earthquake requirements as per GR-63, Issue 3.
EX3200	No performance degradation up to 10,000 feet (3048 meters)	Normal operation ensured in relative humidity range of 10% through 85% (noncondensing)	Normal operation ensured in the temperature range 32° F through 113° F (0° C through 45° C)	Complies with Zone 4 earthquake requirements as per GR-63, Issue 3.
EX3300	No performance degradation up to 10,000 feet (3048 meters)	Normal operation ensured in relative humidity range of 10% through 85% (noncondensing)	Normal operation ensured in the temperature range 32° F through 113° F (0° C through 45° C)	Complies with Zone 4 earthquake requirements as per GR-63, Issue 3.

Table 23: EX Series Switch Environmental Tolerances (*continued*)

Switch or device	Environment Tolerance			
	Altitude	Relative humidity	Temperature	Seismic
EX4200	No performance degradation up to 10,000 feet (3048 meters)	Normal operation ensured in relative humidity range of 10% through 85% (noncondensing)	Normal operation ensured in the temperature range 32° F through 113° F (0° C through 45° C)	Complies with Zone 4 earthquake requirements as per GR-63, Issue 3.
EX4500	No performance degradation up to 10,000 feet (3048 meters)	Normal operation ensured in relative humidity range of 10% through 85% (noncondensing)	Normal operation ensured in the temperature range 32° F through 113° F (0° C through 45° C)	Complies with Zone 4 earthquake requirements as per GR-63, Issue 3.
EX6210	No performance degradation up to 10,000 feet (3048 meters)	Normal operation ensured in relative humidity range of 10% through 85% (noncondensing)	Normal operation ensured in the temperature range 32° F through 104° F (0° C through 40° C)	Complies with Zone 4 earthquake requirements as per GR-63, Issue 3.
EX8208	No performance degradation up to 10,000 feet (3048 meters)	Normal operation ensured in relative humidity range of 10% through 85% (noncondensing)	Normal operation ensured in the temperature range 32° F through 104° F (0° C through 40° C)	Complies with Zone 4 earthquake requirements as per GR-63, Issue 3.
EX8216	No performance degradation up to 10,000 feet (3048 meters)	Normal operation ensured in relative humidity range of 10% through 85% (noncondensing)	Normal operation ensured in the temperature range 32° F through 104° F (0° C through 40° C)	Complies with Zone 4 earthquake requirements as per GR-63, Issue 3.
XRE200	No performance degradation up to 10,000 feet (3048 meters)	Normal operation ensured in relative humidity range of 10% through 85% (noncondensing)	Normal operation ensured in the temperature range 41° F through 104° F (5° C through 40° C)	Complies with Zone 4 earthquake requirements as per GR-63, Issue 3.



NOTE: Install EX Series switches only in restricted areas, such as dedicated equipment rooms and equipment closets, in accordance with Articles 110–16, 110–17, and 110–18 of the National Electrical Code, ANSI/NFPA 70.

Related Documentation

- Clearance Requirements for Airflow and Hardware Maintenance for EX2200 Switches
- Clearance Requirements for Airflow and Hardware Maintenance for EX3200 Switches
- [Clearance Requirements for Airflow and Hardware Maintenance for EX3300 Switches on page 64](#)
- Clearance Requirements for Airflow and Hardware Maintenance for EX4200 Switches
- Clearance Requirements for Airflow and Hardware Maintenance for EX4500 Switches
- Clearance Requirements for Airflow and Hardware Maintenance for an EX6210 Switch
- Clearance Requirements for Airflow and Hardware Maintenance for an EX8208 Switch

- Clearance Requirements for Airflow and Hardware Maintenance for an EX8216 Switch

CHAPTER 5

Mounting and Clearance Requirements

- Rack Requirements for EX3300 Switches on page 61
- Cabinet Requirements for EX3300 Switches on page 62
- Requirements for Mounting an EX3300 Switch on a Desktop or Wall on page 63
- Clearance Requirements for Airflow and Hardware Maintenance for EX3300 Switches on page 64

Rack Requirements for EX3300 Switches

You can mount the switch on two-post racks or four-post racks.

Rack requirements consist of:

- Rack type
- Mounting bracket hole spacing
- Rack size and strength
- Rack connection to the building structure

Table 24 on page 61 provides the rack requirements and specifications for the switch.

Table 24: Rack Requirements and Specifications for the Switch

Rack Requirement	Guidelines
Rack type	<p>Use a two-post rack or a four-post rack. You can mount the switch on any two-post or four-post rack that provides bracket holes or hole patterns spaced at 1 U (1.75 in. or 4.45 cm) increments and that meets the size and strength requirements to support the weight.</p> <p>A U is the standard rack unit defined in <i>Cabinets, Racks, Panels, and Associated Equipment</i> (document number EIA-310-D) published by the Electronics Industry Association (http://www.eia.org).</p>
Mounting bracket hole spacing	<p>The holes in the mounting brackets are spaced at 1 U (1.75 in. or 4.45 cm), so that the switch can be mounted in any rack that provides holes spaced at that distance.</p>

Table 24: Rack Requirements and Specifications for the Switch (*continued*)

Rack Requirement	Guidelines
Rack size and strength	<ul style="list-style-type: none"> • Ensure that the rack complies with the size and strength standards of a 19-in. rack as defined in <i>Cabinets, Racks, Panels, and Associated Equipment</i> (document number EIA-310-D) published by the Electronics Industry Association (http://www.eia.org). • Ensure that the rack rails are spaced widely enough to accommodate the external dimensions of the switch chassis. The outer edges of the front mount brackets extend the width of the chassis to 19 in. (48.2 cm). • The rack must be strong enough to support the weight of the switch. • Ensure that the spacing of rails and adjacent racks allows for the proper clearance around the switch and rack.
Rack connection to building structure	<ul style="list-style-type: none"> • Secure the rack to the building structure. • If earthquakes are a possibility in your geographical area, secure the rack to the floor. • Secure the rack to the ceiling brackets as well as wall or floor brackets for maximum stability.

One pair of mounting brackets for mounting the switch on two posts of a rack is supplied with each switch. For mounting the switch on four posts of a rack or cabinet, you can order a four-post rack-mount kit separately.

Related Documentation

- [Chassis Physical Specifications for EX3300 Switches on page 5](#)
- [Clearance Requirements for Airflow and Hardware Maintenance for EX3300 Switches on page 64](#)
- [Rack-Mounting and Cabinet-Mounting Warnings on page 158](#)
- [Mounting an EX3300 Switch on Two Posts in a Rack or Cabinet on page 82](#)
- [Mounting an EX3300 Switch on Four Posts in a Rack or Cabinet on page 85](#)

Cabinet Requirements for EX3300 Switches

You can mount the switch in a cabinet that contains a 19-in. rack.

Cabinet requirements consist of:

- Cabinet size
- Clearance requirements
- Cabinet airflow requirements

[Table 25 on page 63](#) provides the cabinet requirements and specifications for the switch.

Table 25: Cabinet Requirements and Specifications for the Switch

Cabinet Requirement	Guidelines
Cabinet size	<ul style="list-style-type: none"> You can mount the switch in a cabinet that contains a 19-in. rack as defined in <i>Cabinets, Racks, Panels, and Associated Equipment</i> (document number EIA-310-D) published by the Electronics Industry Association (http://www.eia.org). The minimum cabinet size must be able to accommodate the maximum external dimensions of the switch.
Cabinet clearance	<ul style="list-style-type: none"> The outer edges of the mounting brackets extend the width of the chassis to 19 in. (48.2 cm). The minimum total clearance inside the cabinet is 30 in. (76.2 cm) between the inside of the front door and the inside of the rear door.
Cabinet airflow requirements	<p>When you mount the switch in a cabinet, ensure that ventilation through the cabinet is sufficient to prevent overheating.</p> <ul style="list-style-type: none"> Ensure adequate cool air supply to dissipate the thermal output of the switch or switches. Ensure that the cabinet allows the hot air exhaust of the chassis to exit the cabinet without recirculating into the switch. An open cabinet (without a top or doors) that employs hot air exhaust extraction from the top allows the best airflow through the chassis. If the cabinet contains a top or doors, perforations in these elements assist with removing the hot air exhaust. Install the switch in the cabinet in a way that maximizes the open space on the side of the chassis that has the hot air exhaust. This arrangement maximizes the clearance for critical airflow. Route and dress all cables to minimize the blockage of airflow to and from the chassis. Ensure that the spacing of rails and adjacent cabinets allows for the proper clearance around the switch and cabinet. A cabinet larger than the minimum required provides better airflow and reduces the chance of overheating.

Related Documentation

- [Chassis Physical Specifications for EX3300 Switches on page 5](#)
- [Clearance Requirements for Airflow and Hardware Maintenance for EX3300 Switches on page 64](#)
- [Rack-Mounting and Cabinet-Mounting Warnings on page 158](#)
- [Mounting an EX3300 Switch on Two Posts in a Rack or Cabinet on page 82](#)
- [Mounting an EX3300 Switch on Four Posts in a Rack or Cabinet on page 85](#)

Requirements for Mounting an EX3300 Switch on a Desktop or Wall

You can install the switch on a desktop or wall. When choosing a location, allow at least 6 in. (15.2 cm) of clearance between the front and back of the chassis and adjacent equipment or walls.

Ensure that the wall onto which the switch is installed is stable and securely supported.

If you are mounting the switch in sheetrock (wall board with a gypsum plaster core) or in wall board not backed by wall studs, use hollow wall anchors capable of supporting the combined weight of two fully loaded chassis. Insert the screws into wall studs wherever possible to provide added support for the chassis.

Use the wall-mount kit from Juniper Networks to mount the switch on a wall. The wall-mount kit is not part of the standard package and must be ordered separately.

Related Documentation

- [Clearance Requirements for Airflow and Hardware Maintenance for EX3300 Switches on page 64](#)
- [Wall-Mounting Warning for EX3300 Switches on page 162](#)
- [Mounting an EX3300 Switch on a Desk or Other Level Surface on page 88](#)
- [Mounting an EX3300 Switch on a Wall on page 89](#)

Clearance Requirements for Airflow and Hardware Maintenance for EX3300 Switches

When planning the site for installing an EX3300 switch, you must allow sufficient clearance around the installed switch (see [Figure 12 on page 64](#)).

Figure 12: Clearance Requirements for Airflow and Hardware Maintenance for EX3300 Switches

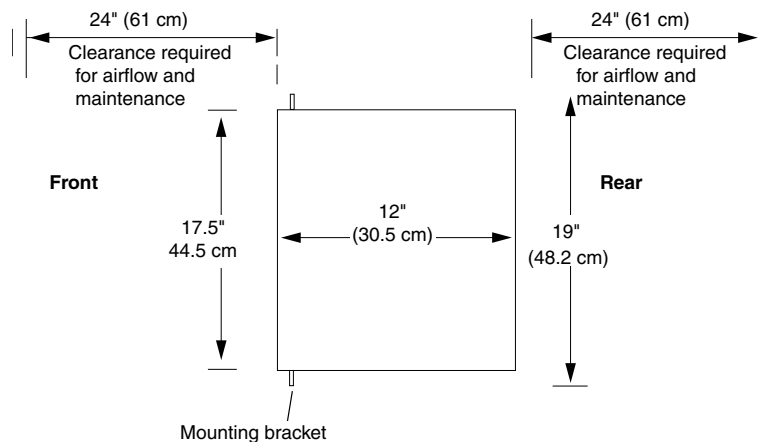

The power cord retainer extends out of the rear of the chassis by 3 in. (7.62cm).

Follow these clearance requirements:

- Allow at least 6 in. (15.2 cm) of clearance on the side between devices that have fans or blowers installed. Allow 2.8 in. (7 cm) between the side of the chassis and any non-heat-producing surface such as a wall. For the cooling system to function properly, the airflow around the chassis must be unrestricted.

[Figure 13 on page 65](#) shows airflow in a front-to-back airflow model.

Figure 13: Front-to-Back Airflow Through the EX3300 Switch Chassis

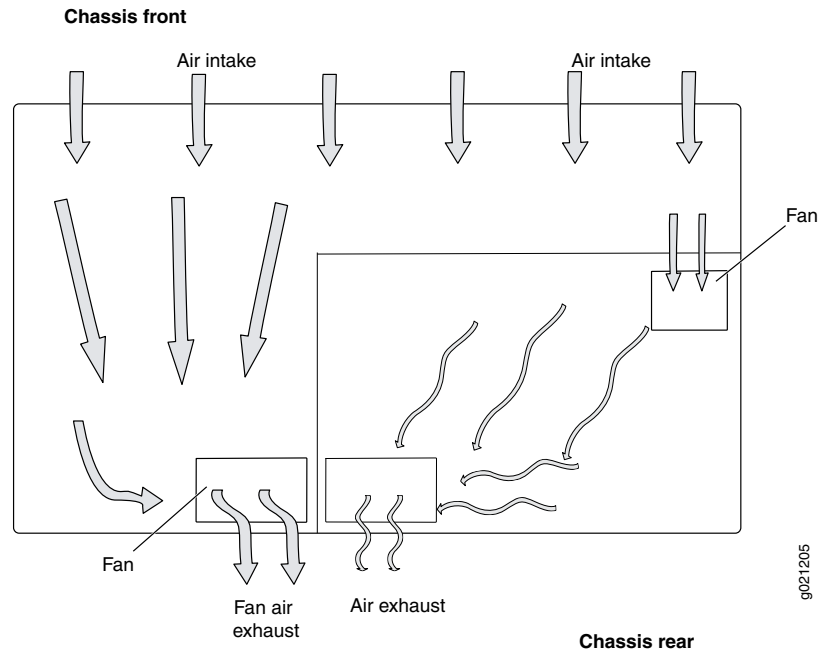
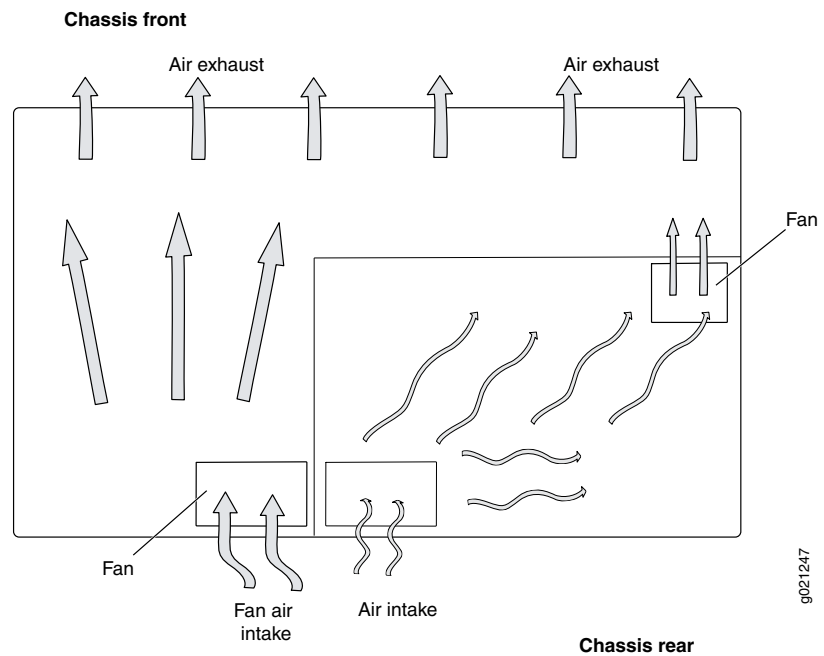

Figure 14 on page 65 shows airflow through a back-to-front airflow model.

Figure 14: Back-to-Front Airflow Through the EX3300 Switch Chassis



- If you are mounting an EX3300 switch in a rack or cabinet with other equipment, or if you are placing it on the desktop or floor near other equipment, ensure that the exhaust from other equipment does not blow into the intake vents of the chassis.

- Leave at least 24 in. (61 cm) in front of the switch and behind the switch. For service personnel to remove and install hardware components, you must leave adequate space at the front and back of the switch. NEBS GR-63 recommends that you allow at least 30 in. (76.2 cm) in front of the rack or cabinet and 24 in. (61 cm) behind the rack or cabinet.

**Related
Documentation**

- [Rack Requirements for EX3300 Switches on page 61](#)
- [Cabinet Requirements for EX3300 Switches on page 62](#)
- [General Site Guidelines on page 54](#)
- [Rack-Mounting and Cabinet-Mounting Warnings on page 158](#)
- [Cooling System and Airflow in an EX3300 Switch on page 22](#)

CHAPTER 6

Cable Specifications

- [Network Cable Specifications for EX3300 Switches on page 67](#)

Network Cable Specifications for EX3300 Switches

EX3300 switches have interfaces that use various types of network cables.

For instructions on connecting the switch to a network for out-of-band management using an Ethernet cable with an RJ-45 connector, see [“Connecting an EX Series Switch to a Network for Out-of-Band Management” on page 106](#).

For instructions on connecting the switch to a management console using an Ethernet cable with an RJ-45 connector, see [“Connecting an EX Series Switch to a Management Console” on page 107](#).

For instructions on connecting a fiber-optic cable to the switch, see [“Connecting a Fiber-Optic Cable to an EX Series Switch” on page 109](#).

Related Documentation

- [Management Port Connector Pinout Information for an EX3300 Switch on page 29](#)
- [Console Port Connector Pinout Information for an EX Series Switch on page 27](#)
- [Front Panel of an EX3300 Switch on page 6](#)
- [Rear Panel of an EX3300 Switch on page 7](#)

CHAPTER 7

Planning Power Requirements

- [Power Specifications for EX3300 Switches on page 69](#)
- [AC Power Cord Specifications for EX3300 Switches on page 70](#)

Power Specifications for EX3300 Switches

This topic describes the power supply electrical specifications for EX3300 switches.

[Table 26 on page 69](#) provides the AC power supply electrical specifications for EX3300 switches.

[Table 27 on page 69](#) provides the DC power supply electrical specifications for EX3300 switches.

Table 26: AC Power Supply Electrical Specifications for EX3300 Switches

Item	Specification
AC input voltage	100 through 240 VAC
AC input line frequency	50 Hz/60 Hz nominal
AC system current rating	<ul style="list-style-type: none">• 7 A at 100 VAC and 2.9 A at 230 VAC (for switches with ports enabled for PoE)• 1.8 A at 100 VAC and 0.5 A at 230 VAC (for switches with no ports enabled for PoE)

Table 27: DC Power Supply Electrical Specifications for EX3300 Switches

Item	Specification
DC input voltage	-43 through -75 VDC
DC input current	2 A maximum
Power supply output	100 W
Output holdup time	1 ms minimum



NOTE: For DC power supplies, we recommend that you provide at least 2.5 A at 48 VDC and use a facility circuit breaker rated for 10 A minimum. Doing so enables you to operate the switch in any configuration without upgrading the power infrastructure, and allows the switch to function at full capacity using multiple power supplies.

Related Documentation

- [AC Power Cord Specifications for EX3300 Switches on page 70](#)
- [Power Supply in EX3300 Switches on page 21](#)
- [General Safety Guidelines and Warnings on page 145](#)
- [General Electrical Safety Guidelines and Warnings on page 169](#)

AC Power Cord Specifications for EX3300 Switches

A detachable AC power cord is supplied with the AC power supplies. The coupler is type C13 as described by International Electrotechnical Commission (IEC) standard 60320. The plug at the male end of the power cord fits into the power source outlet that is standard for your geographical location.



CAUTION: The AC power cord provided with each power supply is intended for use with that power supply only and not for any other use.



NOTE: In North America, AC power cords must not exceed 4.5 meters (approximately 14.75 feet) in length, to comply with National Electrical Code (NEC) Sections 400-8 (NFPA 75, 5-2.2) and 210-52 and Canadian Electrical Code (CEC) Section 4-010(3). The cords supplied with the switch are in compliance.

Table 28 on page 70 lists AC power cord specifications for the countries and regions listed in the table.

Table 28: AC Power Cord Specifications

Country/Region	Electrical Specifications	Plug Standards	Juniper Model Number
Argentina	250 VAC, 10 A, 50 Hz	IRAM 2073 Type RA/3	CBL-EX-PWR-C13-AR
Australia	250 VAC, 10 A, 50 Hz	AS/NZS 3112 Type SAA/3	CBL-EX-PWR-C13-AU
Brazil	250 VAC, 10 A, 50 Hz	NBR 14136 Type BR/3	CBL-EX-PWR-C13-BR
China	250 VAC, 10 A, 50 Hz	GB 1002-1996 Type PRC/3	CBL-EX-PWR-C13-CH

Table 28: AC Power Cord Specifications (*continued*)

Country/Region	Electrical Specifications	Plug Standards	Juniper Model Number
Europe (except Italy, Switzerland, and United Kingdom)	250 VAC, 10 A, 50 Hz	CEE (7) VII Type VIIG	CBL-EX-PWR-C13-EU
India	Country/Region	IS 1293 Type IND/3	CBL-EX-PWR-C13-IN
Israel	250 VAC, 10 A, 50 Hz	SI 32/1971 Type IL/3G	CBL-EX-PWR-C13-IL
Italy	250 VAC, 10 A, 50 Hz	CEI 23-16 Type I/3G	CBL-EX-PWR-C13-IT
Japan	125 VAC, 12 A, 50 Hz or 60 Hz	SS-00259 Type VCTF	CBL-EX-PWR-C13-JP
Korea	250 VAC, 10 A, 50 Hz or 60 Hz	CEE (7) VII Type VIIGK	CBL-EX-PWR-C13-KR
North America	125 VAC, 13 A, 60 Hz	NEMA 5-15 Type N5-15	CBL-EX-PWR-C13-US
South Africa	250 VAC, 10A, 50 Hz	SABS 164/1:1992 Type ZA/13	CBL-EX-PWR-C13-SA
Switzerland	250 VAC, 10 A, 50 Hz	SEV 6534-2 Type 12G	CBL-EX-PWR-C13-SZ
Taiwan	125 VAC, 11 A and 15 A, 50 Hz	NEMA 5-15P Type N5-15P	CBL-EX-PWR-C13-TW
United Kingdom	250 VAC, 10 A, 50 Hz	BS 1363/A Type BS89/13	CBL-EX-PWR-C13-UK

Figure 15 on page 71 illustrates the plug on the power cord for some of the countries or regions listed in Table 28 on page 70.

Figure 15: AC Plug Types

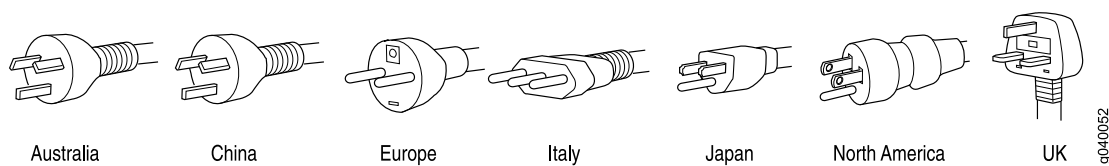

Related Documentation

- [Power Supply in EX3300 Switches on page 21](#)
- [General Safety Guidelines and Warnings on page 145](#)
- [General Electrical Safety Guidelines and Warnings on page 169](#)
- [Prevention of Electrostatic Discharge Damage on page 170](#)

CHAPTER 8

Planning the Virtual Chassis

- [Understanding EX3300 Virtual Chassis Hardware Configuration on page 73](#)
- [Planning EX3300 Virtual Chassis on page 74](#)
- [Virtual Chassis Cabling Configuration Examples for EX3300 Switches on page 74](#)

Understanding EX3300 Virtual Chassis Hardware Configuration

Virtual Chassis is a feature in Juniper Networks EX3300 Ethernet Switches that allows you to interconnect two or more EX3300 switches, enabling them to operate as a unified, single, high bandwidth switch. Starting in Junos OS Release 12.2, you can interconnect a maximum of ten EX3300 switches by using the uplink ports configured as Virtual Chassis ports (VCPs) to form a Virtual Chassis. You can connect up to six EX3300 switches in an EX3300 Virtual Chassis in prior Junos OS releases. By default, uplink ports 2 and 3 are configured as VCPs.



NOTE: EX3300 switches do not have dedicated VCPs.

All EX3300 switch models support Virtual Chassis, and you can interconnect different models, which allows you to choose among a range of possible port configurations within the same Virtual Chassis.

The Virtual Chassis configuration includes a master switch and a backup switch, with all other switches in the configuration designated as “linecard” member switches. Virtual Chassis operation is managed through the master switch. Each switch in the Virtual Chassis is assigned a unique member ID that is displayed on the switch LCD.

Related Documentation

- [Understanding EX2200, EX3300, EX4200, EX4500, and EX4550 Virtual Chassis Components](#)
- [Planning EX3300 Virtual Chassis on page 74](#)

Planning EX3300 Virtual Chassis

Before interconnecting EX3300 switches in a Virtual Chassis configuration, you must consider the following factors:

- The number of switches in the Virtual Chassis and their location—Starting in Junos OS Release 12.2, you can interconnect a maximum of ten EX3300 switches to form a Virtual Chassis composed exclusively of EX3300 switches. You can connect up to six EX3300 switches in an EX3300 Virtual Chassis in prior Junos OS releases.
- Mounting—You can mount the switches in a single rack or install them on multiple racks. For information on the size and strength of racks, see [“Rack Requirements for EX3300 Switches” on page 61](#).
- Cabling requirements for Virtual Chassis—You can interconnect EX3300 switches into a Virtual Chassis through uplink ports configured as Virtual Chassis ports (VCPs). By default, ports 2 and 3 of any uplink module are configured as VCPs.

For information on uplink module port cabling requirements, see [“Network Cable Specifications for EX3300 Switches” on page 67](#).

- Power requirements—You must plan the installation site to meet the power requirements of the switches in a Virtual Chassis. See [“Power Specifications for EX3300 Switches” on page 69](#).

Related Documentation

- [Understanding EX2200, EX3300, EX4200, EX4500, and EX4550 Virtual Chassis Components](#)
- [Understanding EX3300 Virtual Chassis Hardware Configuration on page 73](#)
- [Clearance Requirements for Airflow and Hardware Maintenance for EX3300 Switches on page 64](#)

Virtual Chassis Cabling Configuration Examples for EX3300 Switches

You can install EX3300 switches on a single rack or in multiple racks, or in different wiring closets, and interconnect them to form a Virtual Chassis.

You form an EX3300 Virtual Chassis by connecting uplink port connections as Virtual Chassis ports (VCPs). Ports 2 and 3 are configured as VCPs on all uplink modules by default.

The physical location of the switches in a Virtual Chassis is restricted only by the maximum length supported for cables to connect the VCPs—in this case, the maximum length of the uplink module cables. The maximum cable length for the uplink module cables supported by an EX3300 switch is 6.2 miles (10 km).

The following illustrations show various Virtual Chassis cabling configuration examples.



NOTE: For increased availability and redundancy, we recommend that you always configure your Virtual Chassis in a ring topology.

Figure 16 on page 75, Figure 17 on page 75, and Figure 18 on page 76 show six EX3300 switches stacked vertically in a rack and interconnected in a ring topology.

Figure 16: EX3300 Switches Mounted on a Single Rack and Connected in a Ring Topology: Option 1

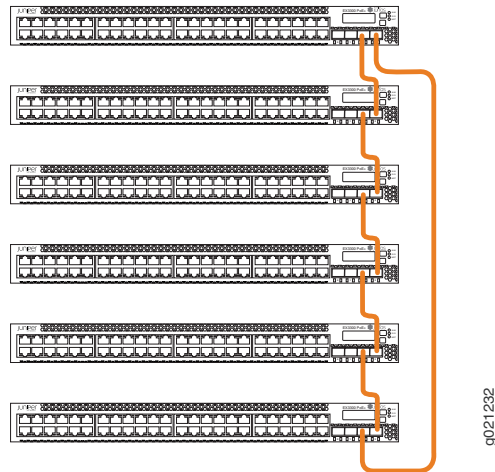

Figure 17: EX3300 Switches Mounted on a Single Rack and Connected in a Ring Topology: Option 2

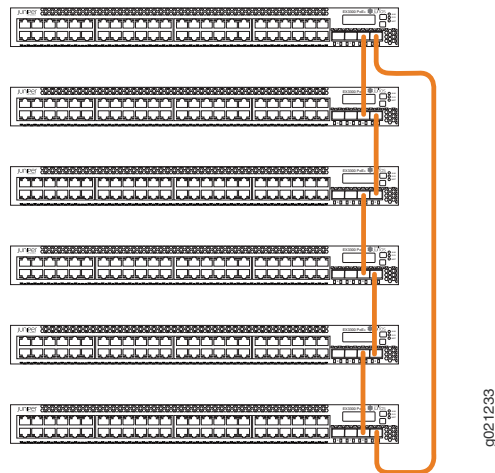

Figure 18: EX3300 Switches Mounted on a Single Rack and Connected in a Ring: Option 3

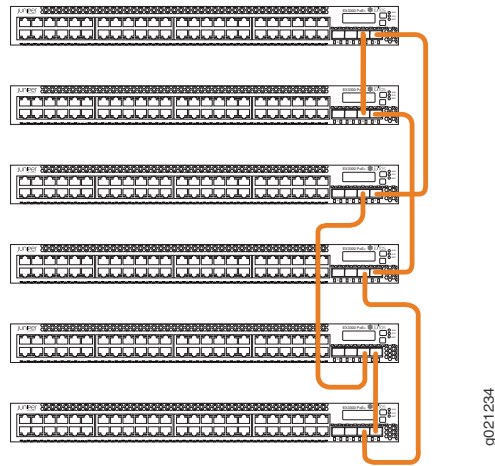

Figure 19 on page 76 and Figure 20 on page 76 show six EX3300 switches mounted on the top rows of adjacent racks and interconnected in a ring topology.

Figure 19: EX3300 Switches Mounted on Adjacent Racks and Connected in a Ring Topology Using Medium and Long Cables: Option 1

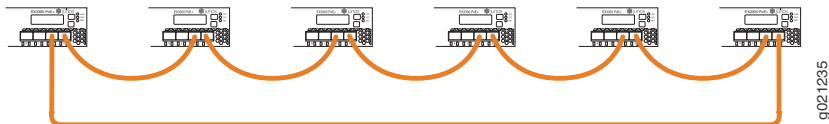
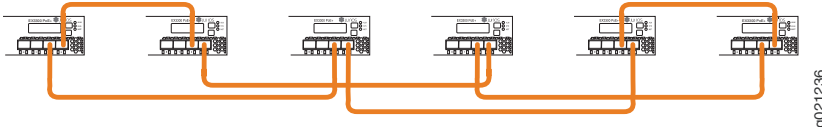

Figure 20: EX3300 Switches Mounted on Adjacent Racks and Connected in a Ring Topology Using Medium and Long Cables: Option 2



Related Documentation

- [Understanding EX3300 Virtual Chassis Hardware Configuration on page 73](#)
- [Understanding EX2200, EX3300, EX4200, EX4500, and EX4550 Virtual Chassis Components](#)
- [Planning EX3300 Virtual Chassis on page 74](#)

PART 3

Installing and Connecting the Switch and Switch Components

- [Installing the Switch on page 79](#)
- [Installing Switch Components on page 93](#)
- [Connecting the Switch on page 97](#)
- [Performing Initial Configuration on page 113](#)

CHAPTER 9

Installing the Switch

- [Installing and Connecting an EX3300 Switch on page 79](#)
- [Unpacking an EX3300 Switch on page 80](#)
- [Parts Inventory \(Packing List\) for an EX3300 Switch on page 81](#)
- [Mounting an EX3300 Switch on page 82](#)
- [Mounting an EX3300 Switch on Two Posts in a Rack or Cabinet on page 82](#)
- [Mounting an EX3300 Switch on Four Posts in a Rack or Cabinet on page 85](#)
- [Mounting an EX3300 Switch in a Recessed Position in a Rack or Cabinet on page 88](#)
- [Mounting an EX3300 Switch on a Desk or Other Level Surface on page 88](#)
- [Mounting an EX3300 Switch on a Wall on page 89](#)

Installing and Connecting an EX3300 Switch

To install and connect an EX3300 switch:

1. Follow instructions in [“Unpacking an EX3300 Switch” on page 80](#).
2. Mount the switch by following instructions appropriate for your site:
 - [“Mounting an EX3300 Switch on Two Posts in a Rack or Cabinet” on page 82](#) (using the mounting brackets provided)
 - [“Mounting an EX3300 Switch on Four Posts in a Rack or Cabinet” on page 85](#) (using the separately orderable four-post rack-mount kit)
 - [“Mounting an EX3300 Switch in a Recessed Position in a Rack or Cabinet” on page 88](#) (using the 2-in.-recess front brackets from the separately orderable four-post rack-mount kit)
 - [“Mounting an EX3300 Switch on a Desk or Other Level Surface” on page 88](#) (using the rubber feet provided)
 - [“Mounting an EX3300 Switch on a Wall” on page 89](#) (using the separately orderable wall-mount kit)
3. Follow instructions in [“Connecting Earth Ground to an EX Series Switch” on page 97](#).

4. Follow instructions in [“Connecting AC Power to an EX3300 Switch” on page 102](#) or [“Connecting DC Power to an EX3300 Switch” on page 103](#).
5. Perform initial configuration of the switch by following instructions in [“Connecting and Configuring an EX Series Switch \(CLI Procedure\)” on page 118](#).
6. Set the switch's management options by following the appropriate instructions:
 - [Connecting an EX Series Switch to a Network for Out-of-Band Management on page 106](#)
 - [Connecting an EX Series Switch to a Management Console on page 107](#)

Related Documentation

- [Rack Requirements for EX3300 Switches on page 61](#)
- [Cabinet Requirements for EX3300 Switches on page 62](#)
- [Clearance Requirements for Airflow and Hardware Maintenance for EX3300 Switches on page 64](#)

Unpacking an EX3300 Switch

The EX3300 switches are shipped in a cardboard carton, secured with foam packing material. The carton also contains an accessory box.



CAUTION: EX3300 switches are maximally protected inside the shipping carton. Do not unpack the switches until you are ready to begin installation.

To unpack the switch:

1. Move the shipping carton to a staging area as close to the installation site as possible, but where you have enough room to remove the system components.
2. Position the carton so that the arrows are pointing up.
3. Open the top flaps on the shipping carton.
4. Remove the accessory box and verify the contents in it against the parts inventory on the label attached to the carton.
5. Pull out the packing material holding the switch in place.
6. Verify the chassis components received against the packing list included with the switch. An inventory of parts provided with the switch is provided in [“Parts Inventory \(Packing List\) for an EX3300 Switch” on page 81](#).
7. Save the shipping carton and packing materials in case you need to move or ship the switch later.

Related Documentation

- [Mounting an EX3300 Switch on page 82](#)
- [Installing and Connecting an EX3300 Switch on page 79](#)

- [Connecting and Configuring an EX Series Switch \(CLI Procedure\) on page 118](#)

Parts Inventory (Packing List) for an EX3300 Switch

The EX3300 switches are shipped in a cardboard carton, secured with foam packing material. The carton also contains an accessory box.

The switch shipment includes a packing list. Check the parts you receive in the switch shipping carton against the items on the packing list. The parts shipped depend on the configuration you order.

If any part on the packing list is missing, contact your customer service representative or contact Juniper customer care from within the U.S. or Canada by telephone at 1-800-638-8296. For international-dial or direct-dial options in countries without toll-free numbers, see <http://www.juniper.net/support/requesting-support.html>.

Table 29 on page 81 lists the parts and their quantities in the packing list.

Table 29: Parts List for an EX3300 Switch

Component	Quantity
Switch with built-in power supply	1
AC power cord appropriate for your geographical location (only for AC switch models)	1
Power cord retainer clip (only for AC switch models)	1
Mounting brackets	2
Mounting screws to attach the mounting brackets to the switch chassis	8
Rubber feet	4
RJ-45 cable and RJ-45 to DB-9 serial port adapter	1
Quick Start installation instructions	1
Juniper Networks Product Warranty	1
End User License Agreement	1



NOTE: You must provide mounting screws that are appropriate for your rack or cabinet to mount the chassis on a rack or a cabinet.

Related Documentation

- [Unpacking an EX3300 Switch on page 80](#)
- [EX3300 Switches Hardware Overview on page 3](#)

Mounting an EX3300 Switch

You can mount the switch:

- On two posts in a 19-in. rack or cabinet by using the mounting brackets provided with the switch.
- On four posts in a 19-in. rack or cabinet by using the separately orderable four-post rack-mount kit.
- In a position recessed 2 in. from the front of a 19-in. rack or cabinet by using the 2-in.-recess front brackets in the separately orderable four-post rack-mount kit. You can mount the switch in this recessed position on two-post or four-post racks and cabinets.
- On a desk or other level surface by using rubber feet. The switch is shipped with four rubber feet to be used to stabilize the chassis on a desk or other level surface.
- On a wall by using the separately orderable wall-mount kit.



WARNING: When mounting an EX3300 switch chassis in a vertical position, orient the front panel of the chassis downward to ensure proper airflow and meet safety requirements in the event of a fire.

The holes in the mounting brackets are placed at 1 U (1.75 in. or 4.45 cm.) apart so that the switch can be mounted in any rack or cabinet that provides holes spaced at that distance.

Related Documentation

- [Mounting an EX3300 Switch on Two Posts in a Rack or Cabinet on page 82](#)
- [Mounting an EX3300 Switch on Four Posts in a Rack or Cabinet on page 85](#)
- [Mounting an EX3300 Switch in a Recessed Position in a Rack or Cabinet on page 88](#)
- [Mounting an EX3300 Switch on a Desk or Other Level Surface on page 88](#)
- [Mounting an EX3300 Switch on a Wall on page 89](#)
- [Connecting Earth Ground to an EX Series Switch on page 97](#)

Mounting an EX3300 Switch on Two Posts in a Rack or Cabinet

You can mount the switch on two posts of a 19-in. rack or cabinet by using the mounting brackets provided with the switch. (The remainder of this topic uses “rack” to mean “rack or cabinet”.)

You can mount the switch on four posts of a four-post rack by using the mounting brackets provided with the separately orderable four-post rack-mount kit. See [“Mounting an EX3300 Switch on Four Posts in a Rack or Cabinet” on page 85](#).



NOTE: If you need to mount the switch in a recessed position on either a two-post rack or a four-post rack, you can use the 2-in.-recess front mount brackets provided in the separately orderable four-post rack-mount kit.

Before mounting the switch on two posts in a rack:

- Verify that the site meets the requirements described in [“Site Preparation Checklist for EX3300 Switches” on page 53](#).
- Place the rack in its permanent location, allowing adequate clearance for airflow and maintenance, and secure it to the building structure.
- Read [“General Safety Guidelines and Warnings” on page 145](#), with particular attention to [“Chassis Lifting Guidelines for EX3300 Switches” on page 157](#).

Ensure that you have the following parts and tools available:

- Phillips (+) screwdriver, number 2
- 2 mounting brackets and 8 mounting screws (provided in the accessory box in the switch carton)
- Screws to secure the chassis to the rack (not provided)
- 2-in.-recess front brackets from the separately orderable four-post rack-mount kit if you will mount the switch in a recessed position



NOTE: One person must be available to lift the switch while another secures the switch to the rack.



CAUTION: If you are mounting multiple units on a rack, mount the heaviest unit at the bottom of the rack and mount the other units from the bottom of the rack to the top in decreasing order of the weight of the units.

To mount the switch on two posts in a rack:

1. Remove the switch from the shipping carton (see [“Unpacking an EX3300 Switch” on page 80](#)).
2. Place the switch on a flat, stable surface.
3. Align the mounting brackets along the front or rear of the side panels of the switch chassis depending on how you want to mount the switch. For example, if you want to front-mount the switch, align the brackets along the front of the chassis. See [Figure 21 on page 84](#).

Figure 21: Attaching the Mounting Bracket Along the Front of the Switch

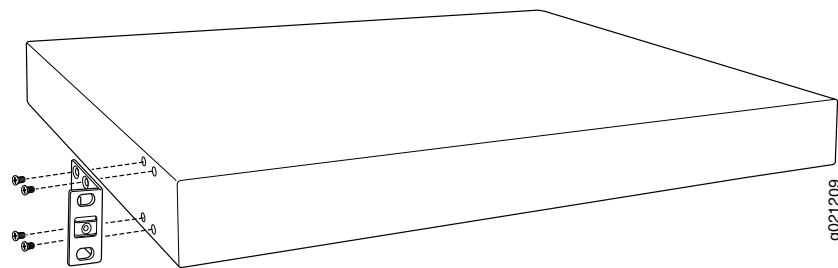

NOTE: If you need to mount the switch in a recessed position, use the 2-in.-recess front mount brackets from the separately orderable four-post rack-mount kit.

4. Align the bottom holes in the mounting brackets with holes on the side panels of the switch chassis.
5. Insert the mounting screws into the aligned holes. Tighten the screws.
6. Ensure that the other holes in the mounting brackets are aligned with the holes in the side panels. Insert a screw in each hole and tighten the screws.
7. Have one person grasp both sides of the switch, lift the switch, and position it in the rack, aligning the mounting bracket holes with the threaded holes in the rack or cabinet rail. Align the bottom hole in each mounting bracket with a hole in each rack rail, making sure the chassis is level. See [Figure 22 on page 84](#).

Figure 22: Mounting the Switch on Two Posts in a Rack

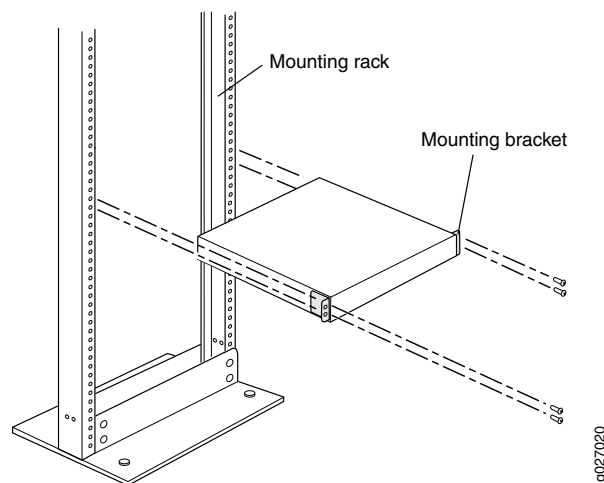

8. Have a second person secure the switch to the rack by using the appropriate screws. Tighten the screws.
9. Ensure that the switch chassis is level by verifying that all screws on one side of the rack are aligned with the screws on the other side.

Related Documentation

- [Connecting Earth Ground to an EX Series Switch on page 97](#)
- [Connecting AC Power to an EX3300 Switch on page 102](#)
- [Connecting DC Power to an EX3300 Switch on page 103](#)
- [Connecting and Configuring an EX Series Switch \(CLI Procedure\) on page 118](#)
- [Mounting an EX3300 Switch in a Recessed Position in a Rack or Cabinet on page 88](#)
- [Rack-Mounting and Cabinet-Mounting Warnings on page 158](#)

Mounting an EX3300 Switch on Four Posts in a Rack or Cabinet

You can mount an EX3300 switch on four posts of a 19-in. rack or cabinet by using the separately orderable four-post rack-mount kit. (The remainder of this topic uses “rack” to mean “rack or cabinet.”)

You can mount the switch on two posts in either a two-post rack or a four-post rack by using the mounting brackets provided with the switch. See [“Mounting an EX3300 Switch on Two Posts in a Rack or Cabinet” on page 82](#).



NOTE: If you need to mount the switch in a recessed position on either a two-post rack or a four-post rack, you can use the 2-in.-recess front brackets provided in the separately orderable four-post rack-mount kit.

Before mounting the switch on four posts in a rack:

- Verify that the site meets the requirements described in [“Site Preparation Checklist for EX3300 Switches” on page 53](#).
- Place the rack in its permanent location, allowing adequate clearance for airflow and maintenance, and secure it to the building structure.
- Read [“General Safety Guidelines and Warnings” on page 145](#), with particular attention to [“Chassis Lifting Guidelines for EX3300 Switches” on page 157](#).

Ensure that you have the following parts and tools available:

- Phillips (+) screwdriver, number 2
- 6 flat-head 4-40 mounting screws (provided with the four-post rack-mount kit)
- 8 flat-head 4x6-mm Phillips mounting screws (provided with the four-post rack-mount kit)
- One pair each of flush or 2-in.-recess front brackets
- One pair of side-rail brackets
- One pair of rear brackets
- Screws to secure the chassis and the rear brackets to the rack (not provided)



NOTE: One person must be available to lift the switch while another secures the switch to the rack.



CAUTION: If you are mounting multiple units on a rack, mount the heaviest unit at the bottom of the rack and mount the other units from the bottom of the rack to the top in decreasing order of the weight of the units.

To mount the switch on four posts in a rack:

1. Remove the switch from the shipping carton (see “Unpacking an EX3300 Switch” on page 80).
2. Attach the front brackets (either the flush or the 2-in.-recess brackets) to the side-rail brackets using six 4-40 flat-head Phillips mounting screws. See Figure 23 on page 86.

Figure 23: Attaching the Front Bracket to the Side-Rail Bracket

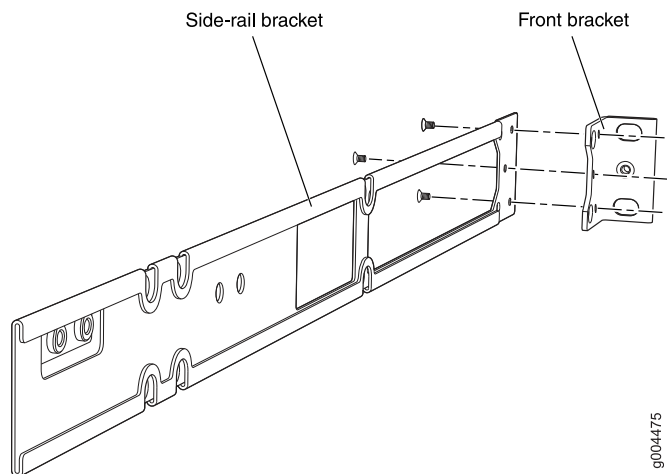

3. Place the switch on a flat, stable surface.
4. Align the side-rail brackets along the side panels of the switch chassis. Align the two holes in the rear of the side-rail brackets with the two holes on the rear of the side panel.
5. Insert 4x6-mm Phillips flat-head mounting screws into the two aligned holes and tighten the screws. Ensure that the two holes in the rear of the side-rail brackets are aligned with the remaining two holes in the side panel. See Figure 24 on page 86.

Figure 24: Attaching the Side-Rail Bracket to the Switch Chassis

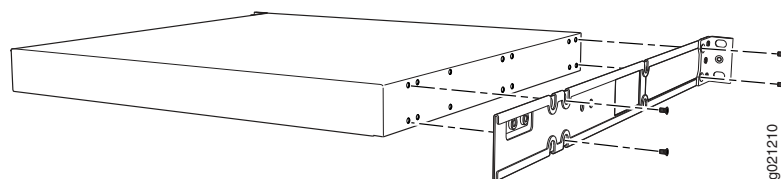

6. Insert the 4x6-mm Phillips flat-head mounting screws into the remaining two holes in the side-rail brackets and tighten the screws.
7. Have one person grasp both sides of the switch, lift the switch, and position it in the rack, aligning the side-rail bracket holes with the threaded holes in the front post of the rack. Align the bottom hole in both the mounting brackets with a hole in each rack rail, making sure the chassis is level. See [Figure 25 on page 87](#).

Figure 25: Mounting the Switch to the Front Posts in a Rack

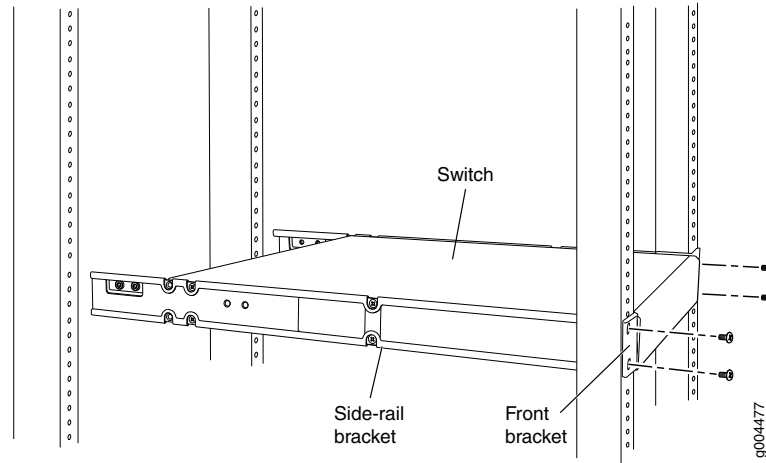

8. Have a second person secure the front of the switch to the rack by using the appropriate screws for your rack.
9. Slide the rear brackets into the side-rail brackets. See [Figure 26 on page 87](#).

Figure 26: Sliding the Rear Brackets to the Rear of a Four-Post Rack

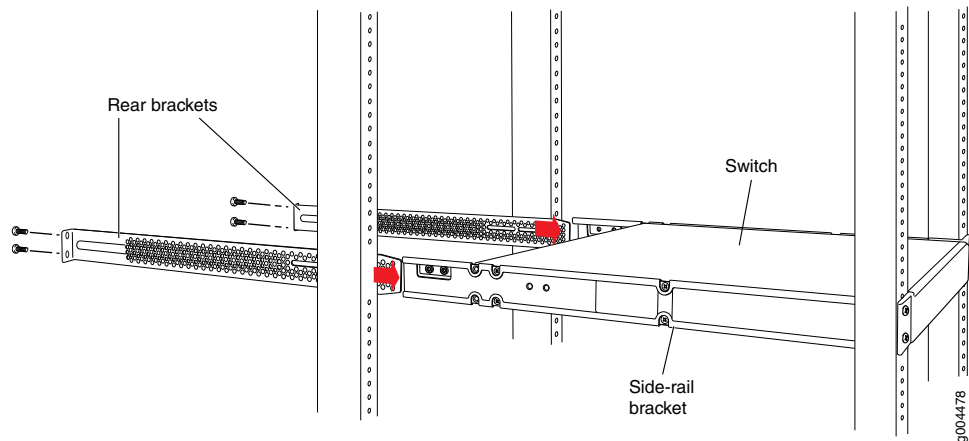

10. Attach the rear brackets to the rear post by using the appropriate screws for your rack. Tighten the screws.
11. Ensure that the switch chassis is level by verifying that all the screws on the front of the rack are aligned with the screws at the back of the rack.

- Related Documentation**
- [Connecting Earth Ground to an EX Series Switch on page 97](#)
 - [Connecting AC Power to an EX3300 Switch on page 102](#)
 - [Connecting DC Power to an EX3300 Switch on page 103](#)
 - [Connecting and Configuring an EX Series Switch \(CLI Procedure\) on page 118](#)
 - [Mounting an EX3300 Switch in a Recessed Position in a Rack or Cabinet on page 88](#)
 - [Rack-Mounting and Cabinet-Mounting Warnings on page 158](#)

Mounting an EX3300 Switch in a Recessed Position in a Rack or Cabinet

You can mount an EX3300 switch in a rack or cabinet such that the switch is recessed inside the rack from the rack front by 2 inches. You can use the 2-in.-recess front brackets provided in the separately orderable four-post rack-mount kit to mount the switch in a recessed position.

Reasons that you might want to mount the switch in a recessed position include:

- You are mounting the switch in a cabinet and the cabinet doors will not close completely unless the switch is recessed.
- The switch you are mounting has transceivers installed in the uplink ports—the transceivers in the uplink ports protrude from the front of the switch.

To mount the switch in a recessed position on four posts, follow the instructions in [“Mounting an EX3300 Switch on Four Posts in a Rack or Cabinet” on page 85](#). To mount the switch in a recessed position on two posts, follow the instructions in [“Mounting an EX3300 Switch on Two Posts in a Rack or Cabinet” on page 82](#).

- Related Documentation**
- [Connecting Earth Ground to an EX Series Switch on page 97](#)
 - [Rack-Mounting and Cabinet-Mounting Warnings on page 158](#)

Mounting an EX3300 Switch on a Desk or Other Level Surface

You can mount an EX3300 switch on a desk or other level surface by using the four rubber feet that are shipped with the switch. The rubber feet stabilize the chassis.

Before mounting the switch on a desk or other level surface:

- Verify that the site meets the requirements described in [“Site Preparation Checklist for EX3300 Switches” on page 53](#).
- Place the desk in its permanent location, allowing adequate clearance for airflow and maintenance, and secure it to the building structure.
- Read [“General Safety Guidelines and Warnings” on page 145](#), with particular attention to [“Chassis Lifting Guidelines for EX3300 Switches” on page 157](#).

Ensure that you have the following parts and tools available:

- 4 rubber feet to stabilize the chassis on the a desk or other level surface (provided in the accessory box in the switch carton)

To mount a switch on a desk or other level surface:

1. Remove the switch from the shipping carton (see “Unpacking an EX3300 Switch” on page 80).
2. Turn the chassis upside down on the desk or the level surface where you intend to mount the switch.
3. Attach the rubber feet to the bottom of the chassis, as shown in Figure 27 on page 89.
4. Turn the chassis right side up on the desk or the level surface.

Figure 27: Attaching Rubber Feet to a Switch Chassis

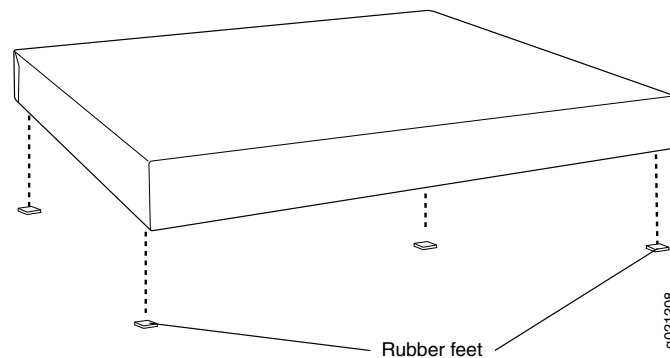

Related Documentation

- [Connecting AC Power to an EX3300 Switch on page 102](#)
- [Connecting DC Power to an EX3300 Switch on page 103](#)
- [Connecting and Configuring an EX Series Switch \(CLI Procedure\) on page 118](#)
- [Clearance Requirements for Airflow and Hardware Maintenance for EX3300 Switches on page 64](#)

Mounting an EX3300 Switch on a Wall

You can mount an EX3300 switch on a wall by using the separately orderable wall-mount kit.



WARNING:

- When mounting an EX3300 switch chassis in a vertical position, orient the front panel of the chassis downward to ensure proper airflow and meet safety requirements in the event of a fire.
- Install the wall-mount baffle above the units to reduce the risk of objects or substances falling into the air exhaust or power supply, which could cause a fire.

Before mounting the switch on a wall:

- Verify that the site meets the requirements described in “[Site Preparation Checklist for EX3300 Switches](#)” on page 53.
- Read “[General Safety Guidelines and Warnings](#)” on page 145, with particular attention to “[Chassis Lifting Guidelines for EX3300 Switches](#)” on page 157.

Ensure that you have the following parts and tools available:

- 2 wall-mount brackets (provided in the wall-mount kit)
- 12 wall-mount bracket screws (provided in the wall-mount kit)
- 6 mounting screws (8-32 x 1.25 in. or M4 x 30 mm) (not provided)
- Hollow wall anchors rated to support up to 75 lb (34 kg) if you are not screwing the screws directly into wall studs (not provided)
- Phillips (+) screwdriver, number 2

To mount one or two switches on a wall:

1. Remove the switch from the shipping carton (see “[Unpacking an EX3300 Switch](#)” on page 80).
2. Attach the wall-mount brackets to the sides of the chassis using four wall-mount bracket screws on each side, as shown in [Figure 28 on page 90](#).

Figure 28: Attaching Wall-Mount Brackets to a Switch Chassis

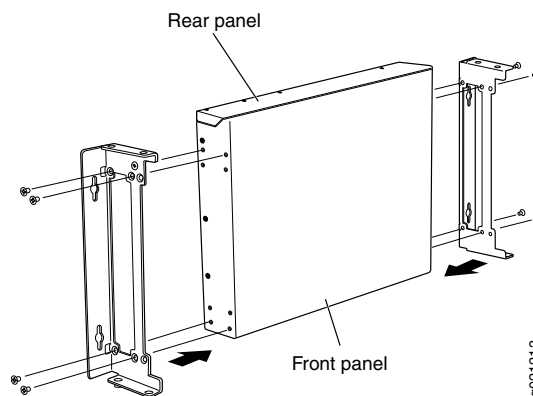

3. If you are mounting two switches together, align the second switch on top of the first in such a way that both the switches have airflow in the same direction and attach it to the mounting brackets using two additional wall-mount bracket screws on each side. ([Figure 30 on page 92](#) shows two aligned switches.)
4. Install six mounting screws in the wall for the wall-mount brackets and baffle as shown in [Figure 29 on page 91](#):
 - Use hollow wall anchors rated to support up to 75 lb (34 kg) if you are not inserting the mounting screws directly into wall studs.

- Turn the screws only part way in, leaving about 1/4 in. (6 mm) distance between the head of the screw and the wall.
- a. Install screw **A**.
 - b. Install screw **B** 18.68 in. (47.4 cm) from screw **A** on a level line.
 - c. Install screw **C** 5.98 in. (15.2 cm) on a plumb line down from screw **A** and screw **D** 5.98 in. down from screw **B**.
 - d. Install screw **E** 2.76 in. (7 cm) up from and 8.32 in. (21.1 cm) to the right of screw **A**.
 - e. Install screw **F** 4.49 in. (11.4 cm) to the right of screw **E**.

Figure 29: Measurements for Installing Mounting Screws

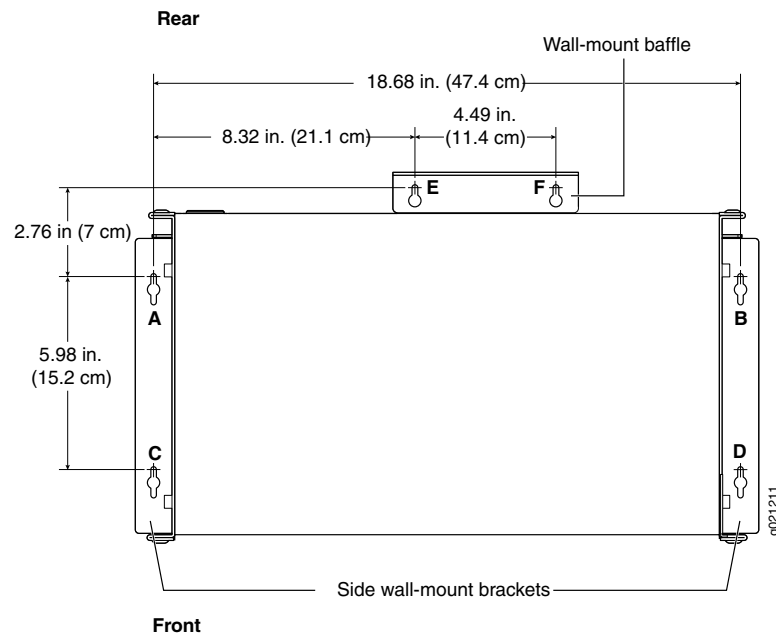

5. Lift the unit (one switch or two) by grasping each side, and hang the unit by attaching the brackets to the mounting screws as shown in [Figure 30 on page 92](#).
6. Tighten all mounting screws.

Figure 30: Mounting the Switch on a Wall

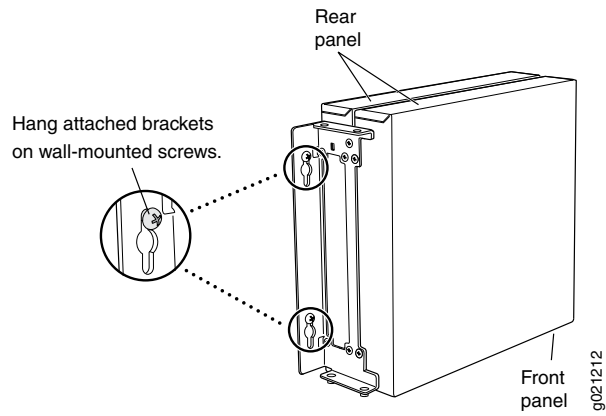

Related Documentation

- [Connecting AC Power to an EX3300 Switch on page 102](#)
- [Connecting DC Power to an EX3300 Switch on page 103](#)
- [Connecting and Configuring an EX Series Switch \(CLI Procedure\) on page 118](#)
- [Wall-Mounting Warning for EX3300 Switches on page 162](#)

Installing Switch Components

- [Installing a Transceiver in an EX Series Switch on page 93](#)

Installing a Transceiver in an EX Series Switch

The transceivers for EX Series switches are hot-removable and hot-insertable field-replaceable units (FRUs): You can remove and replace them without powering off the switch or disrupting switch functions.



NOTE: After you insert a transceiver or after you change the media-type configuration, wait for 6 seconds for the interface to display the operational commands.

Use only optical transceivers and optical connectors purchased from Juniper Networks for your EX Series switches.



NOTE: On an EX3200 switch, if you install a transceiver in a 1-gigabit uplink module port, a corresponding network port from the last four built-in ports is disabled. For example, if you install a transceiver in the 1-gigabit uplink module port 2 (`ge-0/1/2`), then the built-in port 23 (`ge-0/0/22`) is disabled. The disabled port is not listed in the output of `show interface` commands.

Before you begin installing a transceiver in an EX Series switch, ensure that you have taken the necessary precautions for safe handling of lasers (see [“Laser and LED Safety Guidelines and Warnings for EX Series Switches” on page 151](#)).

Ensure that you have a rubber safety cap available to cover the transceiver.

[Figure 31 on page 94](#) shows how to install an SFP transceiver. The procedure is the same for all transceiver types.

To install a transceiver in an EX Series switch:



CAUTION: To avoid electrostatic discharge (ESD) damage to the transceiver, do not touch the connector pins at the end of the transceiver.

1. Remove the transceiver from its bag.
2. Check to see whether the transceiver is covered by a rubber safety cap. If it is not, cover the transceiver with a rubber safety cap.



WARNING: Do not leave a fiber-optic transceiver uncovered except when inserting or removing a cable. The rubber safety cap keeps the port clean and prevents accidental exposure to laser light.

3. If the port in which you want to install the transceiver is covered with a dust cover, remove the dust cover and save it in case you need to cover the port later. If you are hot-swapping a transceiver, wait for at least 10 seconds after removing the transceiver from the port before installing a new transceiver.
4. Using both hands, carefully place the transceiver in the empty port. The connectors must face the switch chassis.



CAUTION: Before you slide the transceiver into the port, ensure the transceiver is aligned correctly. Misalignment might cause the pins to bend, making the transceiver unusable.

5. Slide the transceiver in gently until it is fully seated.
6. Remove the rubber safety cap when you are ready to connect the cable to the transceiver.



WARNING: Do not look directly into a fiber-optic transceiver or into the ends of fiber-optic cables. Fiber-optic transceivers and fiber-optic cables connected to transceivers emit laser light that can damage your eyes.

Figure 31: Installing a Transceiver in an EX Series Switch

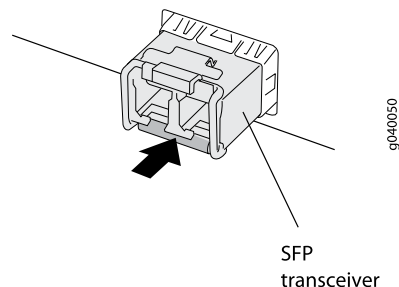

- Related Documentation**
- [Removing a Transceiver from an EX Series Switch on page 127](#)
 - [Connecting a Fiber-Optic Cable to an EX Series Switch on page 109](#)
 - [Optical Interface Support in EX2200 Switches](#)
 - [Optical Interface Support in EX3200 Switches](#)
 - [Optical Interface Support in EX3300 Switches on page 30](#)
 - [Optical Interface Support in EX4200 Switches](#)
 - [Optical Interface Support in EX4500 Switches](#)
 - [Optical Interface Support in EX6200 Switches](#)
 - [Optical Interface Support in EX8200 Switches](#)

Connecting the Switch

- [Connecting Earth Ground to an EX Series Switch on page 97](#)
- [Connecting AC Power to an EX3300 Switch on page 102](#)
- [Connecting DC Power to an EX3300 Switch on page 103](#)
- [Connecting an EX Series Switch to a Network for Out-of-Band Management on page 106](#)
- [Connecting an EX Series Switch to a Management Console on page 107](#)
- [Connecting a Fiber-Optic Cable to an EX Series Switch on page 109](#)

Connecting Earth Ground to an EX Series Switch

To ensure proper operation and to meet safety and electromagnetic interference (EMI) requirements, you must connect an EX Series switch to earth ground before you connect power to the switch. Use the protective earthing terminal on the switch chassis to connect to the earth ground (see [Figure 33 on page 101](#)).



NOTE: Chassis grounding is required for DC systems and recommended for AC systems. An AC-powered EX Series switch chassis gets additional grounding when you plug the power supply in the switch into a grounded AC power outlet by using an AC power cord appropriate for your geographical location.



CAUTION: Before you connect earth ground to the protective earthing terminal of an EX Series switch, ensure that a licensed electrician has attached an appropriate grounding lug to the grounding cable.

Using a grounding cable with an incorrectly attached lug can damage the switch.

This topic describes:

- [Parts and Tools Required for Connecting an EX Series Switch to Earth Ground on page 98](#)
- [Special Instructions to Follow Before Connecting Earth Ground to a Switch on page 99](#)
- [Connecting Earth Ground to an EX Series Switch on page 101](#)

Parts and Tools Required for Connecting an EX Series Switch to Earth Ground

Table 30 on page 98 lists the earthing terminal location, grounding cable requirements, grounding lug specifications, screws and washers required, and the screwdriver needed for connecting a switch to earth ground. Before you begin connecting a switch to earth ground, ensure you have the parts and tools required for your switch.

Table 30: Parts and Tools Required for Connecting an EX Series Switch to Earth Ground

Switch	Earthing Terminal Location	Grounding Cable Requirements	Grounding Lug Specifications	Screws and Washers	Screwdriver	Additional Information
EX2200	Rear of chassis	14 AWG (2 mm ²), minimum 90°C wire, or as permitted by the local code	Panduit LCD6-14BH-L or equivalent	<ul style="list-style-type: none"> • Two 10-32 x .25-in. screws with #10 split-lock washer • Two #10 flat washers 	Phillips (+) number 2	
EX3200	Rear of chassis	14 AWG (2 mm ²), minimum 90°C wire, or as permitted by the local code	Panduit LCD6-14BH-L or equivalent	<ul style="list-style-type: none"> • Two 10-32 x .25-in. screws with #10 split-lock washer • Two #10 flat washers 	Phillips (+) number 2	See “Special Instructions to Follow Before Connecting Earth Ground to a Switch” on page 99.
EX3300	Rear of chassis	14 AWG (2 mm ²), minimum 90°C wire, or as permitted by the local code	Panduit LCD6-14BH-L or equivalent	<ul style="list-style-type: none"> • Two 10-32 x .25-in. screws with #10 split-lock washer • Two #10 flat washers 	Phillips (+) number 2	
EX4200	Left side of chassis	14 AWG (2 mm ²), minimum 90°C wire, or as permitted by the local code	Panduit LCD6-14BH-L or equivalent	<ul style="list-style-type: none"> • Two 10-32 x .25-in. screws with #10 split-lock washer • Two #10 flat washers 	Phillips (+) number 2	See “Special Instructions to Follow Before Connecting Earth Ground to a Switch” on page 99.
EX4500	Left side of chassis	14 AWG (2 mm ²), minimum 90°C wire, or as permitted by the local code	Panduit LCD6-14BH-L or equivalent—not provided	<ul style="list-style-type: none"> • Two 10-32 x .25-in. screws with #10 split-lock washer • Two #10 flat washers 	Phillips (+) number 2	See “Special Instructions to Follow Before Connecting Earth Ground to a Switch” on page 99.

Table 30: Parts and Tools Required for Connecting an EX Series Switch to Earth Ground (continued)

Switch	Earthing Terminal Location	Grounding Cable Requirements	Grounding Lug Specifications	Screws and Washers	Screwdriver	Additional Information
EX6210	Rear of chassis (on lower left side)	The grounding cable must be the same gage as the power feed cables and as permitted by the local code.	Panduit LCD2-14A-Q or equivalent—provided	<ul style="list-style-type: none"> Two ¼-20 x 0.5-in. screws with #¼" split-washer—provided Two #¼" flat washers—provided 	Phillips (+) number 2	
EX8208	Left side of chassis	6 AWG (13.3 mm ²), minimum 60°C wire, or as permitted by the local code	Panduit LCD2-14A-Q or equivalent—provided	<ul style="list-style-type: none"> Two ¼-20 x 0.5-in. screws with #¼" split-washer—provided Two #¼" flat washers—provided 	Phillips (+) number 2	
EX8216	Two earthing terminals: <ul style="list-style-type: none"> Left side of chassis Rear of chassis 	2 AWG (33.6 mm ²), minimum 60°C wire, or as permitted by the local code	Panduit LCD2-14A-Q or equivalent—provided	<ul style="list-style-type: none"> Two ¼-20 x 0.5-in. screws with #¼" split-washer—provided Two #¼" flat washers—provided 	Phillips (+) number 2	See "Special Instructions to Follow Before Connecting Earth Ground to a Switch" on page 99.

Special Instructions to Follow Before Connecting Earth Ground to a Switch

Table 31 on page 99 lists the special instructions that you might need to follow before connecting earth ground to a switch.

Table 31: Special Instructions to Follow Before Connecting Earth Ground to a Switch

Switch	Special Instructions
EX3200	NOTE: Some early models of EX3200 switches for which the Juniper Networks product number on the label next to the protective earthing terminal is from 750-021xxx through 750-030xxx require 10-24x.25-in. screws.

Table 31: Special Instructions to Follow Before Connecting Earth Ground to a Switch (*continued*)

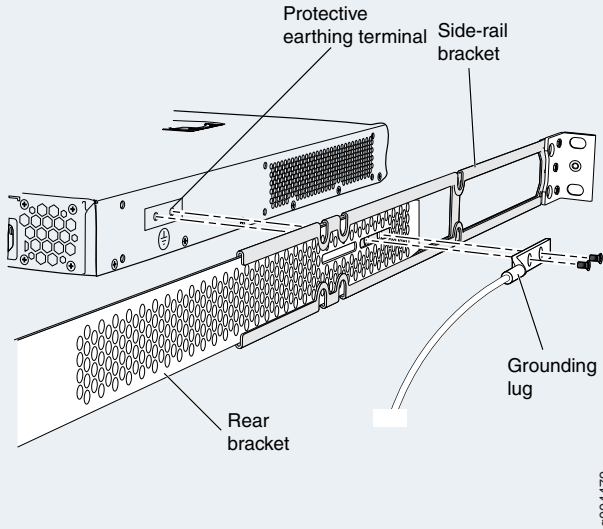
Switch	Special Instructions
EX4200	<p>NOTE: Some early models of EX4200 switches for which the Juniper Networks product number on the label next to the protective earthing terminal is from 750-021xxx through 750-030xxx require 10-24x.25-in. screws.</p> <p>NOTE: The protective earthing terminal on an EX4200 switch mounted on four posts is accessible through the slot on the left rear bracket only if the rack is 27.5 in. deep through 30.5 in. deep for a switch mounted flush with the rack front and 29.5 in. deep through 32.5 in. deep for a switch mounted 2 in. recessed from the rack front. See Figure 32 on page 100.</p> <p>Figure 32: Connecting the Grounding Lug to an EX4200 Switch on a Four-Post Rack</p>  <p>NOTE: The brackets must be attached to the chassis before the grounding lug is attached. (The brackets are shown pulled away from the chassis so that the protective earthing terminal can be seen.)</p>
EX4500	<p>NOTE: If you plan to mount your switch on four posts of a rack or cabinet, mount your switch in the rack or cabinet before attaching the grounding lug to the switch. See Mounting an EX4500 Switch on Four Posts in a Rack or Cabinet.</p> <p>NOTE: The protective earthing terminal on an EX4500 switch mounted on four posts is accessible through the slot on the left rear bracket only if the rack is 27.5 in. deep through 30.5 in. deep for a switch mounted flush with the rack front and 29.5 in. deep through 32.5 in. deep for a switch mounted 2 in. recessed from the rack front.</p>
EX8216	<p>NOTE: Only one of the two protective earthing terminals needs to be permanently connected to earth ground.</p>

Connecting Earth Ground to an EX Series Switch

To connect earth ground to a switch:

1. Connect one end of the grounding cable to a proper earth ground, such as the rack in which the switch is mounted.
2. Place the grounding lug attached to the grounding cable over the protective earthing terminal. See [Figure 33 on page 101](#).

Figure 33: Connecting a Grounding Cable to an EX Series Switch

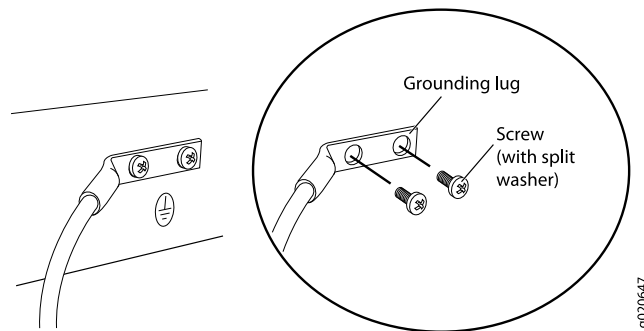

3. Secure the grounding lug to the protective earthing terminal with the washers and screws.
4. Dress the grounding cable and ensure that it does not touch or block access to other switch components.



WARNING: Ensure that the cable does not drape where people could trip over it.

Related Documentation

- [Connecting AC Power to an EX2200 Switch](#)
- [Connecting DC Power to an EX2200 Switch](#)
- [Connecting AC Power to an EX3200 Switch](#)
- [Connecting DC Power to an EX3200 Switch](#)
- [Connecting AC Power to an EX3300 Switch on page 102](#)
- [Connecting DC Power to an EX3300 Switch on page 103](#)
- [Connecting AC Power to an EX4200 Switch](#)
- [Connecting DC Power to an EX4200 Switch](#)
- [Connecting AC Power to an EX4500 Switch](#)
- [Connecting DC Power to an EX4500 Switch](#)
- [Connecting AC Power to an EX6200 Switch](#)
- [Connecting DC Power to an EX6200 Switch](#)

- [Connecting AC Power to an EX8200 Switch](#)
- [Connecting DC Power to an EX8200 Switch](#)
- [General Safety Guidelines and Warnings on page 145](#)
- [Grounded Equipment Warning on page 162](#)

Connecting AC Power to an EX3300 Switch

The power supply is built in along the rear panel, with an AC power cord inlet on the rear panel.

Ensure that you have the following parts and tools available:

- A power cord appropriate for your geographical location
- A power cord retainer clip

Ensure that you have connected the switch chassis to earth ground.



CAUTION: To meet safety and electromagnetic interference (EMI) requirements and to ensure proper operation, you must connect the switches to earth ground before you connect them to power. For installations that require a separate grounding conductor to the chassis, use the protective earthing terminal on the switch chassis to connect to the earth ground. For instructions on connecting earth ground, see [“Connecting Earth Ground to an EX Series Switch” on page 97](#). An EX3300 switch gets additional grounding when you plug the power supply in the switch into a grounded AC power outlet by using the AC power cord appropriate for your geographical location (see [“AC Power Cord Specifications for EX3300 Switches” on page 70](#)).



NOTE: Grounding is required for DC systems and recommended for AC systems. An AC-powered switch gets additional grounding when you plug the power supply in the switch into a grounded AC power outlet by using the AC power cord appropriate for your geographical location.

To connect AC power to the switch:

1. Squeeze the two sides of the power cord retainer clip and insert the L-shaped ends of the wire clip into the holes in the bracket on each side of the AC power cord inlet ([Figure 34 on page 103](#)).

The power cord retainer clip extends out of the chassis by 3 in.

2. Locate the power cord or cords shipped with the switch; the cords have plugs appropriate for your geographical location. See [“AC Power Cord Specifications for EX3300 Switches” on page 70](#).



WARNING: Ensure that the power cord does not drape where people can trip on it or block access to switch components.

3. Insert the coupler end of the power cord into the AC power cord inlet on the rear panel.
4. Push the power cord into the slot in the adjustment nut of the power cord retainer clip. Turn the nut until it is tight against the base of the coupler and the slot in the nut is turned 90° from the top of the switch (see [Figure 35 on page 103](#)).
5. If the AC power source outlet has a power switch, set it to the OFF (O) position.
6. Insert the power cord plug into an AC power source outlet.
7. If the AC power source outlet has a power switch, set it to the ON (I) position.

Figure 34: Connecting an AC Power Cord Retainer Clip to the AC Power Cord Inlet

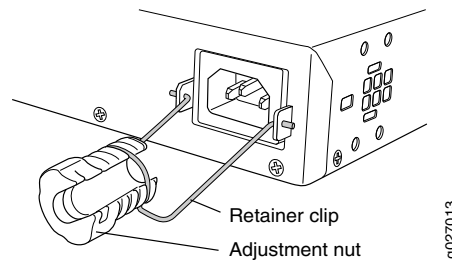
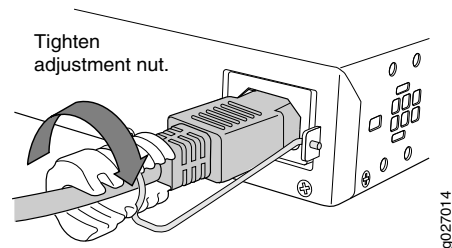

Figure 35: Connecting an AC Power Cord to the AC Power Cord Inlet



Related Documentation

- [Connecting and Configuring an EX Series Switch \(CLI Procedure\) on page 118](#)
- [Power Supply in EX3300 Switches on page 21](#)

Connecting DC Power to an EX3300 Switch

The power supply is built in along the rear panel.



WARNING: DC-powered switches are intended for installation only in a restricted access location.

Before you begin connecting DC power to the switch, ensure that you have connected the switch chassis to earth ground.



CAUTION: Before you connect power to the switch, a licensed electrician must attach a cable lug to the grounding and power cables that you supply. A cable with an incorrectly attached lug can damage the switch (for example, by causing a short circuit).

To meet safety and electromagnetic interference (EMI) requirements and to ensure proper operation, you must connect the switch to earth ground before you connect them to power. For installations that require a separate grounding conductor to the chassis, use the protective earthing terminal on the switch chassis to connect to the earth ground. For instructions on connecting earth ground, see [“Connecting Earth Ground to an EX Series Switch” on page 97](#).



NOTE: Grounding is required for DC systems and recommended for AC systems. An AC-powered switch gets additional grounding when you plug the power supply in the switch into a grounded AC power outlet by using the AC power cord appropriate for your geographical location.

Ensure that you have the following parts and tools available:

- DC power source cables (14 AWG) with ring lug (Molex 0190700067 or equivalent) (not provided) attached to them by a licensed electrician
- Phillips (+) screwdriver, number 2

To connect DC power to the switch:

1. Ensure that the input circuit breaker is open so that the cable leads will not become active while you are connecting DC power.



NOTE: The DC power supply in the switch has four terminals labeled A+, B+, A–, and B– for connecting DC power source cables labeled positive (+) and negative (–). The terminals are covered by a clear plastic cover.



NOTE: The A+ and B+ terminals are referred to as +RTN and A– and B– terminals are referred to as –48 V in [“DC Power Wiring Sequence Warning” on page 179](#) and [“DC Power Electrical Safety Guidelines” on page 175](#).

2. Grasp the plastic cover in the middle, gently flex it outwards, and pull it out. Save the cover.
3. Remove the screws on the terminals using the screwdriver. Save the screws.



WARNING: Ensure that the power cables do not block access to switch components or drape where people can trip on them.

4. Connect the power supply to the power sources. Secure power source cables to the power supply by screwing the ring lugs attached to the cables to the appropriate terminals by using the screw from the terminals (see [Figure 36 on page 105](#)).

Figure 36: Securing Ring Lugs to the Terminals on the DC Power Supply

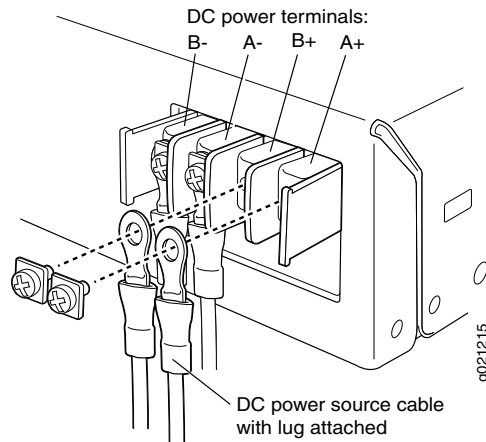

- To connect the power supply to a power source:
 - a. Secure the ring lug of the positive (+) DC power source cable to the A+ or B+ terminal on the DC power supply.
 - b. Secure the ring lug of the negative (–) DC power source cable to the A– or B– terminal on the DC power supply.
 - c. Tighten the screws on the power supply terminals until snug using the screwdriver. Do not overtighten—apply between 8 in.-lb (0.9 Nm) and 9 in.-lb (1.02 Nm) of torque to the screws.
- To connect the power supply to two power sources:
 - a. Secure the ring lug of the positive (+) DC power source cable from the first DC power source to the A+ terminal on the power supply.
 - b. Secure the ring lug of the negative (–) DC power source cable from the first DC power source to the A– terminal on the power supply.
 - c. Secure the ring lug of the positive (+) DC power source cable from the second DC power source to the B+ terminal on the power supply.

- d. Secure the ring lug of the negative (–) DC power source cable from the second DC power source to the B– terminal on the power supply.
 - e. Tighten the screws on the power supply terminals on both the power supplies until snug using the screwdriver. Do not overtighten—apply between 8 in.-lb (0.9 Nm) and 9 in.-lb (1.02 Nm) of torque to the screws.
5. Hook the plastic cover on one side of the terminal block and gently flex it inwards to hook it on the other side also.
 6. Close the input circuit breaker.

**Related
Documentation**

- [Connecting and Configuring an EX Series Switch \(CLI Procedure\) on page 118](#)
- [Power Supply in EX3300 Switches on page 21](#)

Connecting an EX Series Switch to a Network for Out-of-Band Management

This topic applies to multiple hardware devices in the EX Series product family, which includes switches and the XRE200 External Routing Engine.

You can monitor and manage these devices using a dedicated management channel. Each device has a management port with an RJ-45 connector for out-of-band management. Use the management port to connect the EX Series switch or external Routing Engine to the management device.

Ensure that you have an Ethernet cable with an RJ-45 connector available. One such cable is provided with the device. [Figure 37 on page 106](#) shows the RJ-45 connector of the Ethernet cable supplied with the device.

Figure 37: Ethernet Cable Connector

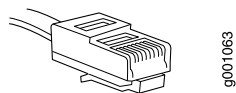

To connect a device to a network for out-of-band management (see [Figure 38 on page 107](#)):

1. Connect one end of the Ethernet cable to the management port (labeled **MGMT**) on the device.

For the location of the **MGMT** port on different devices:

- See EX2200 Switches Hardware Overview.
- See Rear Panel of an EX3200 Switch.
- See [“Rear Panel of an EX3300 Switch” on page 7](#).
- See Rear Panel of an EX4200 Switch.
- See Front Panel of an EX4500 Switch.

- See Switch Fabric and Routing Engine (SRE) Module in an EX6200 Switch.
 - See Switch Fabric and Routing Engine (SRE) Module in an EX8208 Switch.
 - See Routing Engine (RE) Module in an EX8216 Switch.
 - See Front Panel of an XRE200 External Routing Engine.
2. Connect the other end of the Ethernet cable to the management device.

Figure 38: Connecting an EX Series Switch to a Network for Out-of-Band Management

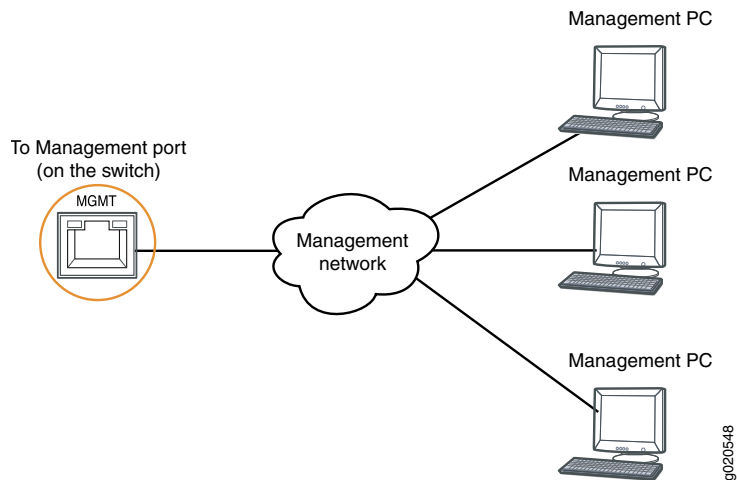

Related Documentation

- [Connecting an EX Series Switch to a Management Console on page 107](#)
- Management Port Connector Pinout Information for an EX2200 Switch
- Management Port Connector Pinout Information for an EX3200 Switch
- [Management Port Connector Pinout Information for an EX3300 Switch on page 29](#)
- Management Port Connector Pinout Information for an EX4200 Switch
- Management Port Connector Pinout Information for an EX4500 Switch
- Management Port Connector Pinout Information for an EX6200 Switch
- Management Port Connector Pinout Information for an EX8200 Switch
- Management Port Connector Pinout Information for an XRE200 External Routing Engine
- Cables Connecting the EX6200 Switch to Management Devices
- Cables Connecting the EX8200 Switch to Management Devices

Connecting an EX Series Switch to a Management Console

This topic applies to multiple hardware devices in the EX Series product family, which includes switches and the XRE200 External Routing Engine.

You can configure and manage these devices using a dedicated console. Every device has a console port with an RJ-45 connector. Use the console port to connect the device to the management console or to a console server. The console port accepts a cable with an RJ-45 connector.

Ensure that you have an Ethernet cable with an RJ-45 connector available. An RJ-45 cable and an RJ-45 to DB-9 serial port adapter are supplied with the device.

[Figure 39 on page 108](#) shows the RJ-45 connector of the Ethernet cable supplied with the device.

Figure 39: Ethernet Cable Connector

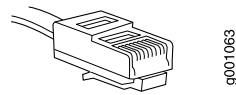

NOTE: If your laptop or PC does not have a DB-9 male connector pin and you want to connect your laptop or PC directly to the device, use a combination of the RJ-45 to DB-9 female adapter supplied with the device and a USB to DB-9 male adapter. You must provide the USB to DB-9 male adapter.

To connect the device to a management console (see [Figure 40 on page 109](#) and [Figure 41 on page 109](#)):

1. Connect one end of the Ethernet cable into the console port (labeled **CON** or **CONSOLE**) on the device.

For the location of the **CON/CONSOLE** port on different devices:

- See EX2200 Switches Hardware Overview.
- See Rear Panel of an EX3200 Switch.
- See [“Rear Panel of an EX3300 Switch” on page 7](#).
- See Rear Panel of an EX4200 Switch.
- See Front Panel of an EX4500 Switch.
- See Switch Fabric and Routing Engine (SRE) Module in an EX6200 Switch.
- See Switch Fabric and Routing Engine (SRE) Module in an EX8208 Switch.
- See Routing Engine (RE) Module in an EX8216 Switch.
- See Front Panel of an XRE200 External Routing Engine.

2. Connect the other end of the Ethernet cable into the console server (see [Figure 40 on page 109](#)) or management console (see [Figure 41 on page 109](#)).

To configure the device from the management console, see [“Connecting and Configuring an EX Series Switch \(CLI Procedure\)” on page 118](#) or [“Connecting and Configuring an EX Series Switch \(J-Web Procedure\)” on page 120](#).



NOTE: EX2200-24T-4G-DC switches do not support switch connection and configuration through the J-Web interface.

Figure 40: Connecting an EX Series Switch to a Management Console Through a Console Server

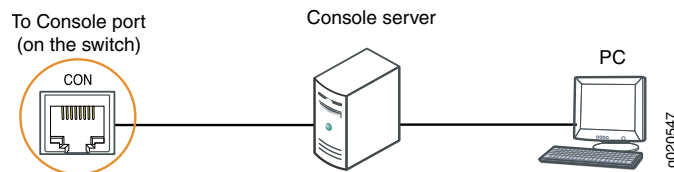
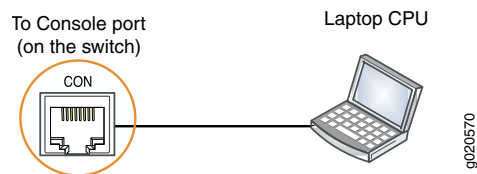

Figure 41: Connecting an EX Series Switch Directly to a Management Console



Related Documentation

- [Configuring the Console Port Type \(CLI Procedure\)](#)
- [Connecting an EX Series Switch to a Network for Out-of-Band Management on page 106](#)
- [Console Port Connector Pinout Information for an EX Series Switch on page 27](#)
- [Cables Connecting the EX6200 Switch to Management Devices](#)
- [Cables Connecting the EX8200 Switch to Management Devices](#)

Connecting a Fiber-Optic Cable to an EX Series Switch

EX Series switches have field-replaceable unit (FRU) optical transceivers to which you can connect fiber-optic cables.

Before you begin connecting a fiber-optic cable to an optical transceiver installed in an EX Series switch, ensure that you have taken the necessary precautions for safe handling of lasers (see [“Laser and LED Safety Guidelines and Warnings for EX Series Switches” on page 151](#)).

To connect a fiber-optic cable to an optical transceiver installed in an EX Series switch:



WARNING: Do not look directly into a fiber-optic transceiver or into the ends of fiber-optic cables. Fiber-optic transceivers and fiber-optic cables connected to transceivers emit laser light that can damage your eyes.

1. If the fiber-optic cable connector is covered by a rubber safety cap, remove the cap. Save the cap.
2. Remove the rubber safety cap from the optical transceiver. Save the cap.
3. Insert the cable connector into the optical transceiver (see [Figure 42 on page 110](#)).

Figure 42: Connecting a Fiber-Optic Cable to an Optical Transceiver Installed in an EX Series Switch

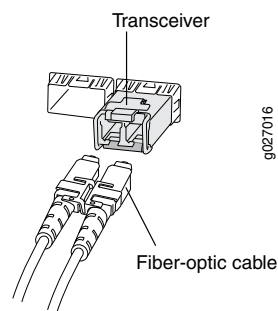

4. Secure the cables so that they are not supporting their own weight. Place excess cable out of the way in a neatly coiled loop. Placing fasteners on a loop helps cables maintain their shape.



CAUTION: Do not bend fiber-optic cables beyond their minimum bend radius. An arc smaller than a few inches in diameter can damage the cables and cause problems that are difficult to diagnose.

Do not let fiber-optic cables hang free from the connector. Do not allow fastened loops of cables to dangle, which stresses the cables at the fastening point.

Related Documentation

- [Disconnecting a Fiber-Optic Cable from an EX Series Switch on page 129](#)
- [Installing a Transceiver in an EX Series Switch on page 93](#)
- [Maintaining Fiber-Optic Cables in EX Series Switches on page 133](#)
- [Optical Interface Support in EX2200 Switches](#)
- [Optical Interface Support in EX3200 Switches](#)
- [Optical Interface Support in EX3300 Switches on page 30](#)
- [Optical Interface Support in EX4200 Switches](#)

- Optical Interface Support in EX4500 Switches
- Optical Interface Support in EX6200 Switches
- Optical Interface Support in EX8200 Switches

Performing Initial Configuration

- [EX3300 Switch Default Configuration on page 113](#)
- [Connecting and Configuring an EX Series Switch \(CLI Procedure\) on page 118](#)
- [Connecting and Configuring an EX Series Switch \(J-Web Procedure\) on page 120](#)

EX3300 Switch Default Configuration

Each EX Series switch is programmed with a factory default configuration that contains the values set for each configuration parameter when a switch is shipped.

The EX3300 switch default configuration:

- Sets Ethernet switching and storm control on all interfaces
- Sets Power over Ethernet (PoE) on all network ports of models that provide PoE
- Enables the following protocols:
 - Internet Group Management Protocol (IGMP) snooping
 - Rapid Spanning Tree Protocol (RSTP)
 - Link Layer Discovery Protocol (LLDP)
 - Link Layer Discovery Protocol Media Endpoint Discovery (LLDP-MED)

When you commit changes to the configuration, a new configuration file is created that becomes the active configuration. You can always revert to the factory default configuration. See [Reverting to the Default Factory Configuration for the EX Series Switch](#).

The following factory default configuration file is for an EX3300 switch with 24 PoE+-capable ports. This file might differ from the default configuration file on your switch in the following ways:

- If your model has 48 ports, the file contains more interfaces, which correspond to the additional network ports.
- If your model is not PoE+-capable, the file does not include the **poE** stanza.



NOTE: All models have four uplink ports as listed below (`ge-0/1/0` to `ge-0/1/3` and `xe-0/1/0` to `xe-0/1/3`). Uplink ports labeled 2 and 3 are configured as Virtual Chassis ports by default. You can configure these ports as network ports.

```
system {
  syslog {
    user * {
      any emergency;
    }
    file messages {
      any notice;
      authorization info;
    }
    file interactive-commands {
      interactive-commands any;
    }
  }
  commit {
    factory-settings {
      reset-chassis-lcd-menu;
      reset-virtual-chassis-configuration;
    }
  }
}
interfaces {
  ge-0/0/0 {
    unit 0 {
      family ethernet-switching;
    }
  }
  ge-0/0/1 {
    unit 0 {
      family ethernet-switching;
    }
  }
  ge-0/0/2 {
    unit 0 {
      family ethernet-switching;
    }
  }
  ge-0/0/3 {
    unit 0 {
      family ethernet-switching;
    }
  }
  ge-0/0/4 {
    unit 0 {
      family ethernet-switching;
    }
  }
  ge-0/0/5 {
    unit 0 {
```

```
        family ethernet-switching;
    }
}
ge-0/0/6 {
    unit 0 {
        family ethernet-switching;
    }
}
ge-0/0/7 {
    unit 0 {
        family ethernet-switching;
    }
}
ge-0/0/8 {
    unit 0 {
        family ethernet-switching;
    }
}
ge-0/0/9 {
    unit 0 {
        family ethernet-switching;
    }
}
ge-0/0/10 {
    unit 0 {
        family ethernet-switching;
    }
}
ge-0/0/11 {
    unit 0 {
        family ethernet-switching;
    }
}
ge-0/0/12 {
    unit 0 {
        family ethernet-switching;
    }
}
ge-0/0/13 {
    unit 0 {
        family ethernet-switching;
    }
}
ge-0/0/14 {
    unit 0 {
        family ethernet-switching;
    }
}
ge-0/0/15 {
    unit 0 {
        family ethernet-switching;
    }
}
ge-0/0/16 {
    unit 0 {
        family ethernet-switching;
```

```
    }  
  }  
  ge-0/0/17 {  
    unit 0 {  
      family ethernet-switching;  
    }  
  }  
  ge-0/0/18 {  
    unit 0 {  
      family ethernet-switching;  
    }  
  }  
  ge-0/0/19 {  
    unit 0 {  
      family ethernet-switching;  
    }  
  }  
  ge-0/0/20 {  
    unit 0 {  
      family ethernet-switching;  
    }  
  }  
  ge-0/0/21 {  
    unit 0 {  
      family ethernet-switching;  
    }  
  }  
  ge-0/0/22 {  
    unit 0 {  
      family ethernet-switching;  
    }  
  }  
  ge-0/0/23 {  
    unit 0 {  
      family ethernet-switching;  
    }  
  }  
  ge-0/1/0 {  
    unit 0 {  
      family ethernet-switching;  
    }  
  }  
  xe-0/1/0 {  
    unit 0 {  
      family ethernet-switching;  
    }  
  }  
  ge-0/1/1 {  
    unit 0 {  
      family ethernet-switching;  
    }  
  }  
  xe-0/1/1 {  
    unit 0 {  
      family ethernet-switching;  
    }  
  }
```



```

}
ge-0/1/2 {
  unit 0 {
    family ethernet-switching;
  }
}
xe-0/1/2 {
  unit 0 {
    family ethernet-switching;
  }
}
ge-0/1/3 {
  unit 0 {
    family ethernet-switching;
  }
}
xe-0/1/3 {
  unit 0 {
    family ethernet-switching;
  }
}
}
protocols {
  igmp-snooping {
    vlan all;
  }
  rstp;
  lldp {
    interface all;
  }
  lldp-med {
    interface all;
  }
}
ethernet-switching-options {
  storm-control {
    interface all;
  }
}
}
poe {
  interface all;
}
}

```

**Related
Documentation**

- [Configuration Files Terms](#)
- [Connecting and Configuring an EX Series Switch \(CLI Procedure\) on page 118](#)
- [Understanding Configuration Files for EX Series Switches](#)
- [EX3300 Switches Hardware Overview on page 3](#)

Connecting and Configuring an EX Series Switch (CLI Procedure)

There are two ways to connect and configure an EX Series switch: one method is through the console using the command-line interface (CLI) and the other is using the J-Web interface.



NOTE: EX2200-24T-4G-DC switches do not support switch connection and configuration through the J-Web interface.

This topic describes the CLI procedure.



NOTE: To run the `ezsetup` script, the switch must have the factory default configuration as the active configuration. If you have configured anything on the switch and want to run `ezsetup`, revert to the factory default configuration. See [Reverting to the Default Factory Configuration for the EX Series Switch](#).

Before you begin connecting and configuring an EX Series switch through the console using the CLI:

- Set the following parameter values in the console server or PC:
 - Baud rate—9600
 - Flow control—None
 - Data—8
 - Parity—None

- Stop bits—1
- DCD state—Disregard

To connect and configure the switch from the console using the CLI:

1. Connect the console port to a laptop or PC using the RJ-45 to DB-9 serial port adapter. The RJ-45 cable and RJ-45 to DB-9 serial port adapter are supplied with the switch.

For the location of the console port on different EX Series switches:

- See EX2200 Switches Hardware Overview.
- See Rear Panel of an EX3200 Switch.
- See [“Rear Panel of an EX3300 Switch” on page 7](#).
- See Rear Panel of an EX4200 Switch.
- See Front Panel of an EX4500 Switch.
- See Switch Fabric and Routing Engine (SRE) Module in an EX6200 Switch.
- See Switch Fabric and Routing Engine (SRE) Module in an EX8208 Switch.
- See Routing Engine (RE) Module in an EX8216 Switch.



NOTE: In EX2200-C switches, you can also use Mini-USB Type-B console port to connect to a laptop or PC. See [Connecting an EX2200 Switch to a Management Console Using Mini-USB Type-B Console Port](#).

2. At the Junos OS shell prompt `root%`, type `ezsetup`.
3. Enter the hostname. This is optional.
4. Enter the root password you plan to use for this device. You are prompted to re-enter the root password.
5. Enter **yes** to enable services like Telnet and SSH. By default, Telnet is not enabled and SSH is enabled.



NOTE: When Telnet is enabled, you will not be able to log in to an EX Series switch through Telnet using root credentials. Root login is allowed only for SSH access.

6. Use the Management Options page to select the management scenario:



NOTE: On EX4500, EX6200, and EX8200 switches, only the out-of-band management option is available.

- **Configure in-band management.** In this scenario you have the following two options:
 - Use the default VLAN.
 - Create a new VLAN—If you select this option, you are prompted to specify the VLAN name, VLAN ID, management IP address, and default gateway. Select the ports that must be part of this VLAN.
 - **Configure out-of-band management.** Specify the IP address and gateway of the management interface. Use this IP address to connect to the switch.
7. Specify the SNMP Read Community, Location, and Contact to configure SNMP parameters. These parameters are optional.
 8. Specify the system date and time. Select the time zone from the list. These options are optional.
 9. The configured parameters are displayed. Enter **yes** to commit the configuration. The configuration is committed as the active configuration for the switch.
 10. (For EX4500 switches only) Enter the **request chassis pic-mode intraconnect** operational mode command to set the PIC mode to intraconnect.

You can now log in with the CLI or the J-Web interface to continue configuring the switch. If you use the J-Web interface to continue configuring the switch, the Web session is redirected to the new management IP address. If the connection cannot be made, the J-Web interface displays instructions for starting a J-Web session.

Related Documentation

- [Connecting and Configuring an EX Series Switch \(J-Web Procedure\) on page 120](#)
- [Installing and Connecting an EX2200 Switch](#)
- [Installing and Connecting an EX3200 Switch](#)
- [Installing and Connecting an EX3300 Switch on page 79](#)
- [Installing and Connecting an EX4200 Switch](#)
- [Installing and Connecting an EX4500 Switch](#)
- [Installing and Connecting an EX6210 Switch](#)
- [Installing and Connecting an EX8208 Switch](#)
- [Installing and Connecting an EX8216 Switch](#)

Connecting and Configuring an EX Series Switch (J-Web Procedure)

There are two ways to connect and configure an EX Series switch: one method is through the console using the command-line interface (CLI) and the other is using the J-Web interface.



NOTE: EX2200-24T-4G-DC switches do not support switch connection and configuration through J-Web procedure.

This topic describes the J-Web procedure.



NOTE: Before you begin the configuration, enable a DHCP client on the management PC you will connect to the switch so that the PC can obtain an IP address dynamically.



NOTE: Read the following steps before you begin the configuration. You must complete the initial configuration using EZSetup within 10 minutes. The switch exits EZSetup after 10 minutes and reverts to the factory default configuration, and the PC loses connectivity to the switch.

- EX2200 and EX2200-C switch—The LEDs on the network ports on the front panel blink when the switch is in the initial setup mode.
- EX3200, EX3300, EX4200, EX4500, EX6200, or EX8200 switch—The LCD panel displays a count-down timer when the switch is in initial setup mode.

To connect and configure the switch using the J-Web interface:

1. Transition the switch into initial setup mode:
 - EX2200 and EX2200-C switch—Press the mode button located on the lower right corner of the front panel for 10 seconds.
 - EX3200, EX3300, EX4200, EX4500, EX6200, or EX8200 switch—Use the **Menu** and **Enter** buttons located to the right of the LCD panel (see [Figure 43 on page 121](#)):

Figure 43: LCD Panel in an EX3200, EX4200, EX4500, or EX8200 Switch

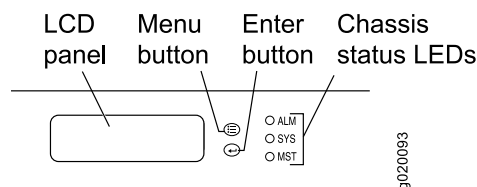

1. Press the **Menu** button until you see **MAINTENANCE MENU**. Then press the **Enter** button.
2. Press **Menu** until you see **ENTER EZSetup**. Then press **Enter**.

If EZSetup does not appear as an option in the menu, select Factory Default to return the switch to the factory default configuration. EZSetup is displayed in the menu of standalone switches only when a switch is set to the factory default configuration.

3. Press **Enter** to confirm setup and continue with EZSetup.

2. Connect the Ethernet cable from the Ethernet port on the PC to the switch.

- EX2200, EX3200, or EX4200 switch—Connect the cable to port 0 (**ge-0/0/0**) on the front panel of the switch.
- EX3300 or EX4500 switch—Connect the cable to the port labeled **MGMT** on the front panel (LCD panel side) of the switch.
- EX6200 switch—Connect the cable to one of the ports labeled **MGMT** on the Switch Fabric and Routing Engine (SRE) module in slot 4 or 5 in an EX6210 switch.
- EX8200 switch—Connect the cable to the port labeled **MGMT** on the Switch Fabric and Routing Engine (SRE) module in slot SRE0 in an EX8208 switch or on the Routing Engine (RE) module in slot RE0 in an EX8216 switch.

These ports are configured as the DHCP server with the default IP address, **192.168.1.1**. The switch can assign an IP address to the management PC in the IP address range **192.168.1.2** through **192.168.1.253**.

3. From the PC, open a Web browser, type **http://192.168.1.1** in the address field, and press Enter.
4. On the J-Web login page, type **root** as the username, leave the password field blank, and click **Login**.
5. On the Introduction page, click **Next**.
6. On the Basic Settings page, modify the hostname, the root password, and date and time settings:
 - Enter the hostname. This is optional.
 - Enter a password and reenter the password.
 - Specify the time zone.
 - Synchronize the date and time settings of the switch with the management PC or set them manually by selecting the appropriate option button. This is optional.

Click **Next**.

7. Use the Management Options page to select the management scenario:



NOTE: On EX4500, EX6210, and EX8200 switches, only the out-of-band management option is available.

- **In-band Management—Use VLAN 'default' for management.**

Select this option to configure all data interfaces as members of the default VLAN. Click **Next**. Specify the management IP address and the default gateway for the default VLAN.

- **In-band Management—Create new VLAN for management.**

Select this option to create a management VLAN. Click **Next**. Specify the VLAN name, VLAN ID, member interfaces, management IP address, and default gateway for the new VLAN.

- **Out-of-band Management—Configure management port.**

Select this option to configure only the management interface. Click **Next**. Specify the IP address and default gateway for the management interface.

8. Click **Next**.
9. On the Manage Access page, you can select options to enable Telnet, SSH, and SNMP services. For SNMP, you can configure the read community, location, and contact.
10. Click **Next**. The Summary screen displays the configured settings.
11. Click **Finish**. The configuration is committed as the active switch configuration.



NOTE: After the configuration is committed, the connectivity between the PC and the switch might be lost. To renew the connection, release and renew the IP address by executing the appropriate commands on the management PC or by removing and reinserting the Ethernet cable.

12. (For EX4500 switches only) In the CLI, enter the **request chassis pic-mode intraconnect** operational mode command to set the PIC mode to intraconnect.

You can now log in using the CLI or the J-Web interface to continue configuring the switch.

If you use the J-Web interface to continue configuring the switch, the Web session is redirected to the new management IP address. If the connection cannot be made, the J-Web interface displays instructions for starting a J-Web session.

Related Documentation

- [Connecting and Configuring an EX Series Switch \(CLI Procedure\) on page 118](#)
- Installing and Connecting an EX2200 Switch
- Installing and Connecting an EX3200 Switch
- [Installing and Connecting an EX3300 Switch on page 79](#)
- Installing and Connecting an EX4200 Switch
- Installing and Connecting an EX4500 Switch
- Installing and Connecting an EX6210 Switch
- Installing and Connecting an EX8208 Switch
- Installing and Connecting an EX8216 Switch

PART 4

Removing Switch Components

- [Removing Switch Components on page 127](#)

Removing Switch Components

- [Removing a Transceiver from an EX Series Switch on page 127](#)
- [Disconnecting a Fiber-Optic Cable from an EX Series Switch on page 129](#)

Removing a Transceiver from an EX Series Switch

The transceivers for EX Series switches are hot-removable and hot-insertable field-replaceable units (FRUs): You can remove and replace them without powering off the switch or disrupting switch functions.



NOTE: After you remove a transceiver or when you change the media-type configuration, wait for 6 seconds for the interface to display the operational commands.

Before you begin removing a transceiver from an EX Series switch, ensure that you have taken the necessary precautions for safe handling of lasers (see [“Laser and LED Safety Guidelines and Warnings for EX Series Switches” on page 151](#)).

Ensure that you have the following parts and tools available:

- An antistatic bag or an antistatic mat
- Needlenose pliers
- Rubber safety caps to cover the transceiver and fiber-optic cable connector
- A dust cover to cover the port

[Figure 44 on page 129](#) shows how to remove an SFP transceiver. The procedure is the same for all transceiver types.

To remove a transceiver from an EX Series switch:

1. Place the antistatic bag or antistatic mat on a flat, stable surface.
2. Label the cable connected to the transceiver so that you can reconnect it correctly.



WARNING: Do not look directly into a fiber-optic transceiver or into the ends of fiber-optic cables. Fiber-optic transceivers and fiber-optic cables connected to transceivers emit laser light that can damage your eyes.



WARNING: Do not leave a fiber-optic transceiver uncovered except when inserting or removing a cable. The rubber safety cap keeps the port clean and prevents accidental exposure to laser light.



CAUTION: Do not bend fiber-optic cables beyond their minimum bend radius. An arc smaller than a few inches in diameter can damage the cables and cause problems that are difficult to diagnose.

3. Remove the cable connected to the transceiver (see [“Disconnecting a Fiber-Optic Cable from an EX Series Switch” on page 129](#)). Cover the transceiver and the end of each fiber-optic cable connector with a rubber safety cap immediately after disconnecting the fiber-optic cables.
4. Using your fingers, pull the ejector lever on the transceiver to unlock the transceiver.



CAUTION: Before removing the transceiver, make sure you open the ejector lever completely until you hear it click. This prevents damage to the transceiver.

5. Using the needlenose pliers, pull the ejector lever out from the transceiver.
6. Grasp the transceiver ejector lever and gently slide the transceiver approximately 0.5 in. (1.3 cm) straight out of the port.



CAUTION: To avoid electrostatic discharge (ESD) damage to the transceiver, do not touch the connector pins at the end of the transceiver.

7. Using your fingers, grasp the body of the transceiver and pull it straight out of the port.
8. Place the transceiver in the antistatic bag or on the antistatic mat placed on a flat, stable surface.
9. Place the dust cover over the empty port.

Figure 44: Removing a Transceiver from an EX Series Switch

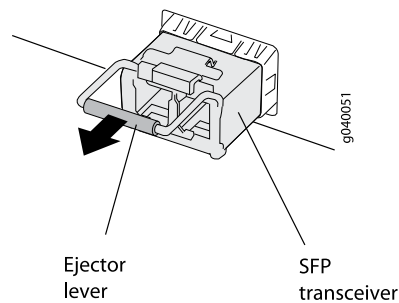

Related Documentation

- [Installing a Transceiver in an EX Series Switch on page 93](#)
- [Optical Interface Support in EX2200 Switches](#)
- [Optical Interface Support in EX3200 Switches](#)
- [Optical Interface Support in EX3300 Switches on page 30](#)
- [Optical Interface Support in EX4200 Switches](#)
- [Optical Interface Support in EX4500 Switches](#)
- [Optical Interface Support in EX6200 Switches](#)
- [Optical Interface Support in EX8200 Switches](#)

Disconnecting a Fiber-Optic Cable from an EX Series Switch

EX Series switches have field-replaceable unit (FRU) optical transceivers to which you can connect fiber-optic cables.

Before you begin disconnecting a fiber-optic cable from an optical transceiver installed in an EX Series switch, ensure that you have taken the necessary precautions for safe handling of lasers (see [“Laser and LED Safety Guidelines and Warnings for EX Series Switches” on page 151](#)).

Ensure that you have the following parts and tools available:

- A rubber safety cap to cover the transceiver
- A rubber safety cap to cover the fiber-optic cable connector

To disconnect a fiber-optic cable from an optical transceiver installed in the switch:

1. Disable the port in which the transceiver is installed by issuing the command:

```
[edit interfaces]  
user@switch# set interface-name disable
```



WARNING: Do not look directly into a fiber-optic transceiver or into the ends of fiber-optic cables. Fiber-optic transceivers and fiber-optic cables connected to transceivers emit laser light that can damage your eyes.

2. Carefully unplug the fiber-optic cable connector from the transceiver.
 3. Cover the transceiver with a rubber safety cap.
-



WARNING: Do not leave a fiber-optic transceiver uncovered except when inserting or removing a cable. The rubber safety cap keeps the port clean and prevents accidental exposure to laser light.

4. Cover the fiber-optic cable connector with the rubber safety cap.

Related Documentation

- [Connecting a Fiber-Optic Cable to an EX Series Switch on page 109](#)
- [Removing a Transceiver from an EX Series Switch on page 127](#)
- [Maintaining Fiber-Optic Cables in EX Series Switches on page 133](#)
- [Optical Interface Support in EX2200 Switches](#)
- [Optical Interface Support in EX3200 Switches](#)
- [Optical Interface Support in EX3300 Switches on page 30](#)
- [Optical Interface Support in EX4200 Switches](#)
- [Optical Interface Support in EX4500 Switches](#)
- [Optical Interface Support in EX6200 Switches](#)
- [Optical Interface Support in EX8200 Switches](#)

PART 5

Switch and Component Maintenance

- [Routine Maintenance on page 133](#)

Routine Maintenance

- [Maintaining Fiber-Optic Cables in EX Series Switches on page 133](#)

Maintaining Fiber-Optic Cables in EX Series Switches

Fiber-optic cables connect to optical transceivers that are installed in EX Series switches.

To maintain fiber-optic cables:

- When you unplug a fiber-optic cable from a transceiver, place rubber safety caps over the transceiver and on the end of the cable.
- Anchor fiber-optic cables to avoid stress on the connectors. When attaching a fiber-optic cable to a transceiver, be sure to secure the fiber-optic cable so that it is not supporting its own weight as it hangs to the floor. Never let a fiber-optic cable hang free from the connector.
- Avoid bending fiber-optic cables beyond their minimum bend radius. Bending fiber-optic cables into arcs smaller than a few inches in diameter can damage the cables and cause problems that are difficult to diagnose.
- Frequent plugging and unplugging of fiber-optic cables in and out of optical instruments can damage the instruments, which are expensive to repair. Attach a short fiber extension to the optical equipment. Any wear and tear due to frequent plugging and unplugging is then absorbed by the short fiber extension, which is easier and less expensive to replace than the instruments.
- Keep fiber-optic cable connections clean. Micro-deposits of oil and dust in the canal of the transceiver or cable connector can cause loss of light, reduction in signal power, and possibly intermittent problems with the optical connection.

To clean the transceiver canal, use an appropriate fiber-cleaning device such as RIFOCS Fiber Optic Adaptor Cleaning Wands (part number 946). Follow the directions in the cleaning kit you use.

After cleaning the transceiver, make sure that the connector tip of the fiber-optic cable is clean. Use only an approved alcohol-free fiber-optic cable cleaning kit such as the Optex Cletop-S[®] Fiber Cleaner. Follow the directions in the cleaning kit you use.

**Related
Documentation**

- [Connecting a Fiber-Optic Cable to an EX Series Switch on page 109](#)
- [Laser and LED Safety Guidelines and Warnings for EX Series Switches on page 151](#)

- Optical Interface Support in EX2200 Switches
- Optical Interface Support in EX3200 Switches
- [Optical Interface Support in EX3300 Switches on page 30](#)
- Optical Interface Support in EX4200 Switches
- Optical Interface Support in EX4500 Switches
- Optical Interface Support in EX6200 Switches
- Optical Interface Support in EX8200 Switches

PART 6

Returning Hardware

- [Returning the Switch or Switch Components on page 137](#)

Returning the Switch or Switch Components

- Returning an EX3300 Switch or Component for Repair or Replacement on page 137
- Locating the Serial Number on an EX3300 Switch or Component on page 138
- Contacting Customer Support to Obtain Return Materials Authorization for EX Series Switches on page 139
- Packing an EX3300 Switch or Component for Shipping on page 141

Returning an EX3300 Switch or Component for Repair or Replacement

If you need to return an EX3300 switch or hardware component to Juniper Networks for repair or replacement, follow this procedure:

1. Determine the serial number of the component. For instructions, see “Locating the Serial Number on an EX3300 Switch or Component” on page 138.
2. Obtain an RMA number from JTAC as described in “Contacting Customer Support to Obtain Return Materials Authorization for EX Series Switches” on page 139.



NOTE: Do not return any component to Juniper Networks unless you have first obtained an RMA number. Juniper Networks reserves the right to refuse shipments that do not have an RMA. Refused shipments are returned to the customer through collect freight.

3. Pack the switch or component for shipping as described in “Packing an EX3300 Switch or Component for Shipping” on page 141.

For more information about return and repair policies, see the customer support page at <http://www.juniper.net/support/guidelines.html>.

Related Documentation

- EX3300 Switches Hardware Overview on page 3

Locating the Serial Number on an EX3300 Switch or Component

If you are returning an EX3300 switch or hardware component to Juniper Networks for repair or replacement, you must locate the serial number of the switch or component. You must provide the serial number to the Juniper Networks Technical Assistance Center (JTAC) when you contact them to obtain Return Materials Authorization (RMA).

If the switch is operational and you can access the CLI, you can list serial numbers for the switch and for some components with a CLI command. If you do not have access to the CLI or if the serial number for the component does not appear in the command output, you can locate the serial number ID label on the physical switch (see [Figure 45 on page 139](#)) or component.



NOTE: If you want to find the serial number on the physical switch component, you will need to remove the component from the switch chassis, for which you must have the required parts and tools available.

- [Listing the Switch and Components Details with the CLI on page 138](#)
- [Locating the Chassis Serial Number ID Label on an EX3300 Switch on page 139](#)

Listing the Switch and Components Details with the CLI

To list the switch and switch components and their serial numbers, enter the following CLI command:

```
user@switch> show chassis hardware
```

```
Hardware inventory:
```

Item	Version	Part number	Serial number	Description
Chassis			GB0210504152	Virtual Chassis
Routing Engine 0	REV 02	750-034250	GB0210504155	EX3300 48-Port POE+
Routing Engine 1	REV 02	750-034250	GB0210504152	EX3300 48-Port POE+
FPC 0	REV 02	750-034250	GB0210504155	EX3300 48-Port POE+
CPU		BUILTIN	BUILTIN	FPC CPU
PIC 0		BUILTIN	BUILTIN	48x 10/100/1000 Base-T
PIC 1	REV 02	750-034250	GB0210504155	4x GE/XE SFP+
Xcvr 0	REV 01	740-021308	63152A01393	SFP+-10G-SR
Xcvr 1	REV 01	740-030658	AD0946A01Z6	SFP+-10G-USR
Power Supply 0				PS 900W AC
Fan Tray				Fan Tray
FPC 1	REV 02	750-034250	GB0210504152	EX3300 48-Port POE+
CPU		BUILTIN	BUILTIN	FPC CPU
PIC 0		BUILTIN	BUILTIN	48x 10/100/1000 Base-T
PIC 1	REV 02	750-034250	GB0210504152	4x GE/XE SFP+
Xcvr 0	REV 01	740-021308	AJPONRC	SFP+-10G-SR
Xcvr 1	REV 01	740-021308	AJNOCXF	SFP+-10G-SR
Xcvr 2	REV 01	740-021308	63152A00952	SFP+-10G-SR
Xcvr 3	REV 01	740-021308	63152A00753	SFP+-10G-SR
Power Supply 0				PS 900W AC
Fan Tray				Fan Tray

Locating the Chassis Serial Number ID Label on an EX3300 Switch

EX3300 switches have serial number ID labels located on the rear panel of the chassis (see [Figure 45 on page 139](#)).

Figure 45: Location of the Serial Number ID Label on EX3300 Switches

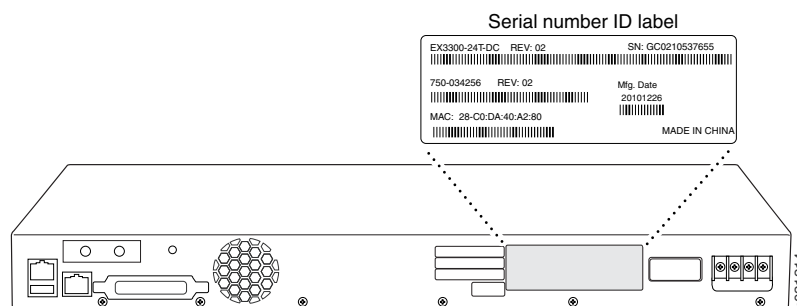

Related Documentation

- [Contacting Customer Support to Obtain Return Materials Authorization for EX Series Switches on page 139](#)
- [Returning an EX3300 Switch or Component for Repair or Replacement on page 137](#)

Contacting Customer Support to Obtain Return Materials Authorization for EX Series Switches

If you are returning a switch or hardware component to Juniper Networks for repair or replacement, obtain a Return Materials Authorization (RMA) from Juniper Networks Technical Assistance Center (JTAC).

After locating the serial number of the switch or hardware component you want to return, open a Case with Juniper Networks Technical Assistance Center (JTAC) on the Web or by telephone.

For instructions on locating the serial number of the switch or hardware component you want to return:

- See [Locating the Serial Number on an EX2200 Switch or Component](#).
- See [Locating the Serial Number on an EX3200 Switch or Component](#).
- See [“Locating the Serial Number on an EX3300 Switch or Component” on page 138](#).
- See [Locating the Serial Number on an EX4200 Switch or Component](#).
- See [Locating the Serial Number on an EX4500 Switch or Component](#).
- See [Locating the Serial Number on an EX6200 Switch or Component](#).
- See [Locating the Serial Number on an EX8200 Switch or Component](#).
- See [Locating the Serial Number on an XRE200 External Routing Engine or Component](#).
- See [Locating the Serial Number on an EX Series Redundant Power System or Redundant Power System Components](#).

Before you request an RMA from JTAC, be prepared to provide the following information:

- Your existing case number, if you have one
- Serial number of the component
- Your name, organization name, telephone number, fax number, and shipping address
- Details of the failure or problem
- Type of activity being performed on the switch when the problem occurred
- Configuration data displayed by one or more **show** commands

You can contact JTAC 24 hours a day, seven days a week on the Web or by telephone:

- Case Manager at CSC: <http://www.juniper.net/cm/>
- Telephone: +1-888-314-JTAC1-888-314-5822, toll free in U.S., Canada, and Mexico



NOTE: For international or direct-dial options in countries without toll free numbers, see <http://www.juniper.net/support/requesting-support.html>.

If you are contacting JTAC by telephone, enter your 11-digit case number followed by the pound (#) key for an existing case, or press the star (*) key to be routed to the next available support engineer.

The support representative validates your request and issues an RMA number for return of the component.

Related Documentation

- Packing an EX2200 Switch or Component for Shipping
- Packing an EX3200 Switch or Component for Shipping
- [Packing an EX3300 Switch or Component for Shipping on page 141](#)
- Packing an EX4200 Switch or Component for Shipping
- Packing an EX4500 Switch or Component for Shipping
- Packing an EX6200 Switch or Component
- Packing an EX8200 Switch or Component
- Packing an EX Series Redundant Power System or Redundant Power System Components for Shipping
- Returning an EX2200 Switch or Component for Repair or Replacement
- Returning an EX3200 Switch or Component for Repair or Replacement
- [Returning an EX3300 Switch or Component for Repair or Replacement on page 137](#)
- Returning an EX4200 Switch or Component for Repair or Replacement
- Returning an EX4500 Switch or Component for Repair or Replacement
- Returning an EX6200 Switch or Component for Repair or Replacement

- Returning an EX8200 Switch or Component for Repair or Replacement
- Returning an EX Series RPS or RPS Component for Repair or Replacement

Packing an EX3300 Switch or Component for Shipping

If you are returning an EX3300 switch or component to Juniper Networks for repair or replacement, pack the item as described in this topic.

Before you begin, ensure that you have retrieved the original shipping carton and packing materials. Contact your JTAC representative if you do not have these materials, to learn about approved packing materials. See [“Contacting Customer Support to Obtain Return Materials Authorization for EX Series Switches”](#) on page 139.

Ensure that you have the following parts and tools available:

- Antistatic bag, one for each switch or component
- Phillips (+) screwdriver, number 2
- [Packing a Switch for Shipping on page 141](#)
- [Packing Switch Components for Shipping on page 142](#)

Packing a Switch for Shipping

To pack a switch for shipping:

1. On the console or other management device connected to the switch, enter the CLI operational mode and issue the following command to shut down the switch software:

```
user@switch> request system halt
```

Wait until a message appears on the console confirming that the operating system has halted.
2. Disconnect power from the switch by performing one of the following:
 - If the power source outlet has a power switch, set it to the OFF (O) position.
 - If the power source outlet does not have a power switch, gently pull out the male end of the power cord connected to the power source outlet.
3. Remove the cables that connect the switch to all external devices. See [“Disconnecting a Fiber-Optic Cable from an EX Series Switch”](#) on page 129.
4. Remove all optical transceivers installed in the switch. See [“Removing a Transceiver from an EX Series Switch”](#) on page 127.
5. If the switch is mounted on a wall or on two posts, have one person support the weight of the switch while another person unscrews and removes the mounting screws. Use the Phillips (+) screwdriver to remove the screws.
6. Remove the switch from the wall, rack, cabinet, or desk and place the switch in an antistatic bag.
7. Slip on the end caps of the packaging foam on both sides of the switch.

8. Place the switch in the shipping carton.
9. Place the packing foam on top of and around the switch.
10. If you are returning accessories or FRUs with the switch, pack them as instructed in [“Packing Switch Components for Shipping” on page 142](#).
11. Close the top of the cardboard carton and seal it with packing tape.
12. Write the RMA number on the exterior of the carton to ensure proper tracking.

Packing Switch Components for Shipping

To pack and ship switch components:

- Place individual components in antistatic bags.
- Ensure that the components are adequately protected with packing materials and packed so that the pieces are prevented from moving around inside the carton.
- Close the top of the cardboard shipping carton and seal it with packing tape.
- Write the RMA number on the exterior of the carton to ensure proper tracking.

Related Documentation

- [Returning an EX3300 Switch or Component for Repair or Replacement on page 137](#)

PART 7

Safety Information

- [General Safety Information on page 145](#)
- [Radiation and Laser Warnings on page 151](#)
- [Installation and Maintenance Safety Information on page 155](#)
- [Power and Electrical Safety Information on page 169](#)

CHAPTER 16

General Safety Information

- [General Safety Guidelines and Warnings on page 145](#)
- [Definitions of Safety Warning Levels on page 146](#)
- [Fire Safety Requirements on page 148](#)
- [Qualified Personnel Warning on page 149](#)
- [Warning Statement for Norway and Sweden on page 150](#)

General Safety Guidelines and Warnings

This topic applies to hardware devices in the EX Series product family, which includes switches, the EX Series Redundant Power System (RPS), and the XRE200 External Routing Engine.

This topic also applies to hardware devices in the QFX Series.

The following guidelines help ensure your safety and protect the device from damage. The list of guidelines might not address all potentially hazardous situations in your working environment, so be alert and exercise good judgment at all times.

- Perform only the procedures explicitly described in the hardware documentation for this device. Make sure that only authorized service personnel perform other system services.
- Keep the area around the device clear and free from dust before, during, and after installation.
- Keep tools away from areas where people could trip over them while walking.
- Do not wear loose clothing or jewelry, such as rings, bracelets, or chains, which could become caught in the device.
- Wear safety glasses if you are working under any conditions that could be hazardous to your eyes.
- Do not perform any actions that create a potential hazard to people or make the equipment unsafe.
- Never attempt to lift an object that is too heavy for one person to handle.
- Never install or manipulate wiring during electrical storms.

- Never install electrical jacks in wet locations unless the jacks are specifically designed for wet environments.
- Operate the device only when it is properly grounded.
- Ensure that the separate protective earthing terminal provided on this device is permanently connected to earth.
- Replace fuses only with fuses of the same type and rating.
- Do not open or remove chassis covers or sheet-metal parts unless instructions are provided in the hardware documentation for this device. Such an action could cause severe electrical shock.
- Do not push or force any objects through any opening in the chassis frame. Such an action could result in electrical shock or fire.
- Avoid spilling liquid onto the chassis or onto any device component. Such an action could cause electrical shock or damage the device.
- Avoid touching uninsulated electrical wires or terminals that have not been disconnected from their power source. Such an action could cause electrical shock.
- Always ensure that all modules, power supplies, and cover panels are fully inserted and that the installation screws are fully tightened.

Related Documentation

- [AC Power Electrical Safety Guidelines on page 172](#)
- [DC Power Electrical Safety Guidelines on page 175](#)
- [General Electrical Safety Guidelines and Warnings on page 169](#)
- [Maintenance and Operational Safety Guidelines and Warnings on page 163](#)
- [Installation Instructions Warning on page 155](#)
- [Grounded Equipment Warning on page 162](#)

Definitions of Safety Warning Levels

This topic applies to hardware devices in the EX Series product family, which includes switches, the EX Series Redundant Power System (RPS), and the XRE200 External Routing Engine.

This topic also applies to hardware devices in the QFX Series.

The documentation uses the following levels of safety warnings (there are two “Warning” formats):



.....
NOTE: You might find this information helpful in a particular situation, or you might overlook this important information if it was not highlighted in a Note.
.....



CAUTION: You need to observe the specified guidelines to avoid minor injury or discomfort to you or severe damage to the device.



WARNING: This symbol alerts you to the risk of personal injury from a laser.



WARNING: This symbol means danger. You are in a situation that could cause bodily injury. Before you work on any equipment, be aware of the hazards involved with electrical circuitry and be familiar with standard practices for preventing accidents.

Waarschuwing Dit waarschuwingssymbool betekent gevaar. U verkeert in een situatie die lichamelijk letsel kan veroorzaken. Voordat u aan enige apparatuur gaat werken, dient u zich bewust te zijn van de bij elektrische schakelingen betrokken risico's en dient u op de hoogte te zijn van standaard maatregelen om ongelukken te voorkomen.

Varoitus Tämä varoitusmerkki merkitsee vaaraa. Olet tilanteessa, joka voi johtaa ruumiinvammaan. Ennen kuin työskentelet minkään laitteiston parissa, ota selvää sähkökytkentöihin liittyvistä vaaroista ja tavanomaisista onnettomuuksien ehkäisykeinoista.

Attention Ce symbole d'avertissement indique un danger. Vous vous trouvez dans une situation pouvant causer des blessures ou des dommages corporels. Avant de travailler sur un équipement, soyez conscient des dangers posés par les circuits électriques et familiarisez-vous avec les procédures couramment utilisées pour éviter les accidents.

Warnung Dieses Warnsymbol bedeutet Gefahr. Sie befinden sich in einer Situation, die zu einer Körperverletzung führen könnte. Bevor Sie mit der Arbeit an irgendeinem Gerät beginnen, seien Sie sich der mit elektrischen Stromkreisen verbundenen Gefahren und der Standardpraktiken zur Vermeidung von Unfällen bewußt.

Avvertenza Questo simbolo di avvertenza indica un pericolo. La situazione potrebbe causare infortuni alle persone. Prima di lavorare su qualsiasi apparecchiatura, occorre conoscere i pericoli relativi ai circuiti elettrici ed essere al corrente delle pratiche standard per la prevenzione di incidenti.

Advarsel Dette varselsymbolet betyr fare. Du befinner deg i en situasjon som kan føre til personskade. Før du utfører arbeid på utstyr, må du være oppmerksom på de faremomentene som elektriske kretser innebærer, samt gjøre deg kjent med vanlig praksis når det gjelder å unngå ulykker.

Aviso Este símbolo de aviso indica perigo. Encontra-se numa situação que lhe poderá causar danos físicos. Antes de começar a trabalhar com qualquer equipamento, familiarize-se com os perigos relacionados com circuitos

elétricos, e com quaisquer práticas comuns que possam prevenir possíveis acidentes.

¡Atención! Este símbolo de aviso significa peligro. Existe riesgo para su integridad física. Antes de manipular cualquier equipo, considerar los riesgos que entraña la corriente eléctrica y familiarizarse con los procedimientos estándar de prevención de accidentes.

Varning! Denna varningssymbol signalerar fara. Du befinner dig i en situation som kan leda till personskada. Innan du utför arbete på någon utrustning måste du vara medveten om farorna med elkretsar och känna till vanligt förfarande för att förebygga skador.

**Related
Documentation**

- [General Safety Guidelines and Warnings on page 145](#)
- [Installation Instructions Warning on page 155](#)
- [Maintenance and Operational Safety Guidelines and Warnings on page 163](#)
- [Grounded Equipment Warning on page 162](#)
- [Laser and LED Safety Guidelines and Warnings for EX Series Switches on page 151](#)
- [Laser and LED Safety Guidelines and Warnings for the QFX Series](#)
- [Warning Statement for Norway and Sweden on page 150](#)

Fire Safety Requirements

This topic applies to hardware devices in the EX Series product family, which includes switches, the EX Series Redundant Power System (RPS), and the XRE200 External Routing Engine.

This topic also applies to hardware devices in the QFX Series.

In the event of a fire emergency involving switches and other network equipment, the safety of people is the primary concern. You should establish procedures for protecting people in the event of a fire emergency, provide safety training, and properly provision fire-control equipment and fire extinguishers.

In addition, you should establish procedures to protect your equipment in the event of a fire emergency. Juniper Networks products should be installed in an environment suitable for electronic equipment. We recommend that fire suppression equipment be available in the event of a fire in the vicinity of the equipment and that all local fire, safety, and electrical codes and ordinances be observed when you install and operate your equipment.

Fire Suppression

In the event of an electrical hazard or an electrical fire, you should first turn power off to the equipment at the source. Then use a Type C fire extinguisher, which uses noncorrosive fire retardants, to extinguish the fire.

Fire Suppression Equipment

Type C fire extinguishers, which use noncorrosive fire retardants such as carbon dioxide and Halotron™, are most effective for suppressing electrical fires. Type C fire extinguishers displace oxygen from the point of combustion to eliminate the fire. For extinguishing fire on or around equipment that draws air from the environment for cooling, you should use this type of inert oxygen displacement extinguisher instead of an extinguisher that leaves residues on equipment.

Do not use multipurpose Type ABC chemical fire extinguishers (dry chemical fire extinguishers). The primary ingredient in these fire extinguishers is monoammonium phosphate, which is very sticky and difficult to clean. In addition, in the presence of minute amounts of moisture, monoammonium phosphate can become highly corrosive and corrodes most metals.

Any equipment in a room in which a chemical fire extinguisher has been discharged is subject to premature failure and unreliable operation. The equipment is considered to be irreparably damaged.



NOTE: To keep warranties effective, do not use a dry chemical fire extinguisher to control a fire at or near a Juniper Networks switch or other network device provided by Juniper. If a dry chemical fire extinguisher is used, the unit is no longer eligible for coverage under a service agreement.

We recommend that you dispose of any irreparably damaged equipment in an environmentally responsible manner.

Related Documentation

- [General Safety Guidelines and Warnings on page 145](#)
- [General Electrical Safety Guidelines and Warnings on page 169](#)
- [Action to Take After an Electrical Accident on page 183](#)

Qualified Personnel Warning

This topic applies to hardware devices in the EX Series product family, which includes switches, the EX Series Redundant Power System (RPS), and the XRE200 External Routing Engine.

This topic also applies to hardware devices in the QFX Series.



WARNING: Only trained and qualified personnel should install or replace the device.

Waarschuwing Installatie en reparaties mogen uitsluitend door getraind en bevoegd personeel uitgevoerd worden.

Varoitus Ainoastaan koulutettu ja pätevä henkilökunta saa asentaa tai vaihtaa tämän laitteen.

Attention Tout installation ou remplacement de l'appareil doit être réalisé par du personnel qualifié et compétent.

Warnung Gerät nur von geschultem, qualifiziertem Personal installieren oder auswechseln lassen.

Avvertenza Solo personale addestrato e qualificato deve essere autorizzato ad installare o sostituire questo apparecchio.

Advarsel Kun kvalifisert personell med riktig opplæring bør montere eller bytte ut dette utstyret.

Aviso Este equipamento deverá ser instalado ou substituído apenas por pessoal devidamente treinado e qualificado.

¡Atención! Estos equipos deben ser instalados y reemplazados exclusivamente por personal técnico adecuadamente preparado y capacitado.

Varning! Denna utrustning ska endast installeras och bytas ut av utbildad och kvalificerad personal.

**Related
Documentation**

- [General Safety Guidelines and Warnings on page 145](#)
- [General Electrical Safety Guidelines and Warnings on page 169](#)
- [AC Power Electrical Safety Guidelines on page 172](#)
- [DC Power Electrical Safety Guidelines on page 175](#)

Warning Statement for Norway and Sweden

This topic applies to hardware devices in the EX Series product family, which includes switches, the EX Series Redundant Power System (RPS), and the XRE200 External Routing Engine.

This topic also applies to hardware devices in the QFX Series.



WARNING: The equipment must be connected to an earthed mains socket-outlet.

Advarsel Apparatet skal kobles til en jordet stikkontakt.

Varning! Apparaten skall anslutas till jordat nätuttag.

**Related
Documentation**

- [General Safety Guidelines and Warnings on page 145](#)

Radiation and Laser Warnings

- [Laser and LED Safety Guidelines and Warnings for EX Series Switches on page 151](#)
- [Radiation from Open Port Apertures Warning on page 153](#)

Laser and LED Safety Guidelines and Warnings for EX Series Switches

EX Series switches and the XRE200 External Routing Engine are equipped with laser transmitters, which are considered a Class 1 Laser Product by the U.S. Food and Drug Administration and are evaluated as a Class 1 Laser Product per EN 60825-1 requirements.

Observe the following guidelines and warnings:

- [General Laser Safety Guidelines on page 151](#)
- [Class 1 Laser Product Warning on page 151](#)
- [Laser Beam Warning on page 152](#)

General Laser Safety Guidelines

When working around ports that support optical transceivers, observe the following safety guidelines to prevent eye injury:

- Do not look into unterminated ports or at fibers that connect to unknown sources.
- Do not examine unterminated optical ports with optical instruments.
- Avoid direct exposure to the beam.



WARNING: Unterminated optical connectors can emit invisible laser radiation. The lens in the human eye focuses all the laser power on the retina, so focusing the eye directly on a laser source—even a low-power laser—could permanently damage the eye.

Class 1 Laser Product Warning



WARNING: Class 1 laser product.

Waarschuwing Klasse-1 laser produkt.

Varoitus Luokan 1 lasertuote.

Attention Produit laser de classe I.

Warnung Laserprodukt der Klasse 1.

.....



WARNING: Avvertenza Prodotto laser di Classe 1.

Advarsel Laserprodukt av klasse 1.

Aviso Produto laser de classe 1.

¡Atención! Producto láser Clase I.

Varning! Laserprodukt av klass 1.

.....

Laser Beam Warning

.....



WARNING: Do not stare into the laser beam or view it directly with optical instruments.

.....



WARNING: Waarschuwing Niet in de straal staren of hem rechtstreeks bekijken met optische instrumenten.

.....



WARNING: Varoitus Älä katso säteeseen äläkä tarkastele sitä suoraan optisen laitteen avulla.

.....



WARNING: Attention Ne pas fixer le faisceau des yeux, ni l'observer directement à l'aide d'instruments optiques.

.....



WARNING: Warnung Nicht direkt in den Strahl blicken und ihn nicht direkt mit optischen Geräten prüfen.

.....



WARNING: Avvertenza Non fissare il raggio con gli occhi né usare strumenti ottici per osservarlo direttamente.

.....



WARNING: Advarsel Stirr eller se ikke direkte p strlen med optiske instrumenter.



WARNING: Aviso Não olhe fixamente para o raio, nem olhe para ele directamente com instrumentos ópticos.



WARNING: ¡Atención! No mirar fijamente el haz ni observarlo directamente con instrumentos ópticos.



WARNING: Varning! Rikta inte blicken in mot strålen och titta inte direkt på den genom optiska instrument.

Related Documentation

- [General Safety Guidelines and Warnings on page 145](#)
- [Radiation from Open Port Apertures Warning on page 153](#)
- [Installation Instructions Warning on page 155](#)
- [Grounded Equipment Warning on page 162](#)
- [Optical Interface Support in EX2200 Switches](#)
- [Optical Interface Support in EX3200 Switches](#)
- [Optical Interface Support in EX3300 Switches on page 30](#)
- [Optical Interface Support in EX4200 Switches](#)
- [Optical Interface Support in EX4500 Switches](#)
- [Optical Interface Support in EX6200 Switches](#)
- [Optical Interface Support in EX8200 Switches](#)

Radiation from Open Port Apertures Warning

This topic applies to hardware devices in the EX Series product family, which includes switches, the EX Series Redundant Power System (RPS), and the XRE200 External Routing Engine.

This topic also applies to hardware devices in the QFX Series.



WARNING: Because invisible radiation might be emitted from the aperture of the port when no fiber cable is connected, avoid exposure to radiation and do not stare into open apertures.

Waarschuwing Aangezien onzichtbare straling vanuit de opening van de poort kan komen als er geen fiberkabel aangesloten is, dient blootstelling aan straling en het kijken in open openingen vermeden te worden.

Varoitus Koska portin aukosta voi emittoitua näkymätöntä säteilyä, kun kuitukaapelia ei ole kytkettynä, vältä säteilylle altistumista äläkä katso avoimiin aukkoihin.

Attention Des radiations invisibles à l'il nu pouvant traverser l'ouverture du port lorsqu'aucun câble en fibre optique n'y est connecté, il est recommandé de ne pas regarder fixement l'intérieur de ces ouvertures.

Warnung Aus der Port-Öffnung können unsichtbare Strahlen emittieren, wenn kein Glasfaserkabel angeschlossen ist. Vermeiden Sie es, sich den Strahlungen auszusetzen, und starren Sie nicht in die Öffnungen!

Avvertenza Quando i cavi in fibra non sono inseriti, radiazioni invisibili possono essere emesse attraverso l'apertura della porta. Evitate di esporvi alle radiazioni e non guardate direttamente nelle aperture.

Advarsel Unngå utsettelse for stråling, og stirr ikke inn i åpninger som er åpne, fordi usynlig stråling kan emitteres fra portens åpning når det ikke er tilkoblet en fiberkabel.

Aviso Dada a possibilidade de emissão de radiação invisível através do orifício da via de acesso, quando esta não tiver nenhum cabo de fibra conectado, deverá evitar a exposição à radiação e não deverá olhar fixamente para orifícios que se encontrarem a descoberto.

¡Atención! Debido a que la apertura del puerto puede emitir radiación invisible cuando no existe un cable de fibra conectado, evite mirar directamente a las aperturas para no exponerse a la radiación.

Varning! Osynlig strålning kan avges från en portöppning utan ansluten fiberkabel och du bör därför undvika att bli utsatt för strålning genom att inte stirra in i oskyddade öppningar.

**Related
Documentation**

- [General Safety Guidelines and Warnings on page 145](#)
- [Laser and LED Safety Guidelines and Warnings for EX Series Switches on page 151](#)
- [Installation Instructions Warning on page 155](#)
- [Grounded Equipment Warning on page 162](#)
- [Laser and LED Safety Guidelines and Warnings for the QFX Series](#)

Installation and Maintenance Safety Information

- Installation Instructions Warning on page 155
- Chassis Lifting Guidelines for EX3300 Switches on page 157
- Ramp Warning on page 157
- Rack-Mounting and Cabinet-Mounting Warnings on page 158
- Wall-Mounting Warning for EX3300 Switches on page 162
- Grounded Equipment Warning on page 162
- Maintenance and Operational Safety Guidelines and Warnings on page 163

Installation Instructions Warning

This topic applies to hardware devices in the EX Series product family, which includes switches, the EX Series Redundant Power System (RPS), and the XRE200 External Routing Engine.

This topic also applies to hardware devices in the QFX Series.



WARNING: Read the installation instructions before you connect the device to a power source.

Waarschuwing Raadpleeg de installatie-aanwijzingen voordat u het systeem met de voeding verbindt.

Varoitus Lue asennusohjeet ennen järjestelmän yhdistämistä virtalähteeseen.

Attention Avant de brancher le système sur la source d'alimentation, consulter les directives d'installation.

Warnung Lesen Sie die Installationsanweisungen, bevor Sie das System an die Stromquelle anschließen.

Avvertenza Consultare le istruzioni di installazione prima di collegare il sistema all'alimentatore.

Advarsel Les installasjonsinstruksjonene før systemet kobles til strømkilden.

Aviso Leia as instruções de instalação antes de ligar o sistema à sua fonte de energia.

¡Atención! Ver las instrucciones de instalación antes de conectar el sistema a la red de alimentación.

Varning! Läs installationsanvisningarna innan du kopplar systemet till dess strömförsörjningsenhet.

Related Documentation

- [General Safety Guidelines and Warnings on page 145](#)
- [Laser and LED Safety Guidelines and Warnings for EX Series Switches on page 151](#)
- Laser and LED Safety Guidelines and Warnings for the QFX Series
- [Grounded Equipment Warning on page 162](#)
- Connecting AC Power to an EX2200 Switch
- Connecting AC Power to an EX3200 Switch
- [Connecting AC Power to an EX3300 Switch on page 102](#)
- Connecting AC Power to an EX4200 Switch
- Connecting AC Power to an EX4500 Switch
- Connecting AC Power to an EX6200 Switch
- Connecting AC Power to an EX8200 Switch
- Connecting DC Power to an EX2200 Switch
- Connecting DC Power to an EX3200 Switch
- [Connecting DC Power to an EX3300 Switch on page 103](#)
- Connecting DC Power to an EX4200 Switch
- Connecting DC Power to an EX4500 Switch
- Connecting DC Power to an EX6200 Switch
- Connecting DC Power to an EX8200 Switch
- Connecting AC Power to an XRE200 External Routing Engine
- Connecting DC Power to an XRE200 External Routing Engine
- Connecting AC Power to a QFX3100 Director Device
- Connecting AC Power to a QFX3008-I Interconnect Device with Single-Phase Wiring Trays
- Connecting AC Power to a QFX3008-I Interconnect Device with Three-Phase Delta Wiring Trays
- Connecting AC Power to a QFX3008-I Interconnect Device with Three-Phase Wye Wiring Trays

- Connecting AC Power to a QFX3500, QFX3600, or QFX3600-I Device

Chassis Lifting Guidelines for EX3300 Switches

The weight of a fully loaded EX3300 switch chassis is approximately 10 lb (4.5 kg). Observe the following guidelines for lifting and moving an EX3300 switch:

- Before installing the switch, read the guidelines in “[Site Preparation Checklist for EX3300 Switches](#)” on page 53 to verify that the intended site meets the specified power, environmental, and clearance requirements.
- Before lifting or moving the switch, disconnect all external cables.
- As when lifting any heavy object, lift most of the weight with your legs rather than your back. Keep your knees bent and your back relatively straight and avoid twisting your body as you lift. Balance the load evenly and be sure that your footing is solid.

Related Documentation

- [General Safety Guidelines and Warnings on page 145](#)
- [Installation Instructions Warning on page 155](#)
- [Mounting an EX3300 Switch on page 82](#)

Ramp Warning

This topic applies to hardware devices in the EX Series product family, which includes switches, the EX Series Redundant Power System (RPS), and the XRE200 External Routing Engine.

This topic also applies to hardware devices in the QFX Series.



WARNING: When installing the device, do not use a ramp inclined at more than 10 degrees.

Waarschuwing Gebruik een oprijplaat niet onder een hoek van meer dan 10 graden.

Varoitus Älä käytä sellaista kaltevaa pintaa, jonka kaltevuus ylittää 10 astetta.

Attention Ne pas utiliser une rampe dont l'inclinaison est supérieure à 10 degrés.

Warnung Keine Rampen mit einer Neigung von mehr als 10 Grad verwenden.

Avvertenza Non usare una rampa con pendenza superiore a 10 gradi.

Advarsel Bruk aldri en rampe som heller mer enn 10 grader.

Aviso Não utilize uma rampa com uma inclinação superior a 10 graus.

¡Atención! No usar una rampa inclinada más de 10 grados

Varning! Använd inte ramp med en lutning på mer än 10 grader.

- Related Documentation**
- [General Safety Guidelines and Warnings on page 145](#)
 - [Installation Instructions Warning on page 155](#)
 - [Grounded Equipment Warning on page 162](#)

Rack-Mounting and Cabinet-Mounting Warnings

This topic applies to hardware devices in the EX Series product family, which includes switches, the EX Series Redundant Power System (RPS), and the XRE200 External Routing Engine.

This topic also applies to hardware devices in the QFX Series.

Ensure that the rack or cabinet in which the device is installed is evenly and securely supported. Uneven mechanical loading could lead to a hazardous condition.



WARNING: To prevent bodily injury when mounting or servicing the device in a rack, take the following precautions to ensure that the system remains stable. The following directives help maintain your safety:

- The device must be installed in a rack that is secured to the building structure.
- The device should be mounted at the bottom of the rack if it is the only unit in the rack.
- When mounting the device on a partially filled rack, load the rack from the bottom to the top with the heaviest component at the bottom of the rack.
- If the rack is provided with stabilizing equipment, install the stabilizers before mounting or servicing the device in the rack.

Waarschuwing Om lichamelijk letsel te voorkomen wanneer u dit toestel in een rek monteert of het daar een servicebeurt geeft, moet u speciale voorzorgsmaatregelen nemen om ervoor te zorgen dat het toestel stabiel blijft. De onderstaande richtlijnen worden verstrekt om uw veiligheid te verzekeren:

- De Juniper Networks switch moet in een stellage worden geïnstalleerd die aan een bouwsel is verankerd.
- Dit toestel dient onderaan in het rek gemonteerd te worden als het toestel het enige in het rek is.

- Wanneer u dit toestel in een gedeeltelijk gevuld rek monteert, dient u het rek van onderen naar boven te laden met het zwaarste onderdeel onderaan in het rek.
- Als het rek voorzien is van stabiliseringshulpmiddelen, dient u de stabilisatoren te monteren voordat u het toestel in het rek monteert of het daar een servicebeurt geeft.

Varoitus Kun laite asetetaan telineeseen tai huolletaan sen ollessa telineessä, on noudatettava erityisiä varotoimia järjestelmän vakavuuden säilyttämiseksi, jotta vältetään loukkaantumiselta. Noudata seuraavia turvallisuusohjeita:

- Juniper Networks switch on asennettava telineeseen, joka on kiinnitetty rakennukseen.
- Jos telineessä ei ole muita laitteita, aseta laite telineen alaosaan.
- Jos laite asetetaan osaksi täytettyyn telineeseen, aloita kuormittaminen sen alaosasta kaikkein raskaimmalla esineellä ja siirry sitten sen yläosaan.
- Jos telinettä varten on vakaimet, asenna ne ennen laitteen asettamista telineeseen tai sen huoltamista siinä.

Attention Pour éviter toute blessure corporelle pendant les opérations de montage ou de réparation de cette unité en casier, il convient de prendre des précautions spéciales afin de maintenir la stabilité du système. Les directives ci-dessous sont destinées à assurer la protection du personnel:

- Le rack sur lequel est monté le Juniper Networks switch doit être fixé à la structure du bâtiment.
- Si cette unité constitue la seule unité montée en casier, elle doit être placée dans le bas.
- Si cette unité est montée dans un casier partiellement rempli, charger le casier de bas en haut en plaçant l'élément le plus lourd dans le bas.
- Si le casier est équipé de dispositifs stabilisateurs, installer les stabilisateurs avant de monter ou de réparer l'unité en casier.

Warnung Zur Vermeidung von Körperverletzung beim Anbringen oder Warten dieser Einheit in einem Gestell müssen Sie besondere Vorkehrungen treffen, um sicherzustellen, daß das System stabil bleibt. Die folgenden Richtlinien sollen zur Gewährleistung Ihrer Sicherheit dienen:

- Der Juniper Networks switch muß in einem Gestell installiert werden, das in der Gebäudestruktur verankert ist.
- Wenn diese Einheit die einzige im Gestell ist, sollte sie unten im Gestell angebracht werden.

- Bei Anbringung dieser Einheit in einem zum Teil gefüllten Gestell ist das Gestell von unten nach oben zu laden, wobei das schwerste Bauteil unten im Gestell anzubringen ist.
- Wird das Gestell mit Stabilisierungszubehör geliefert, sind zuerst die Stabilisatoren zu installieren, bevor Sie die Einheit im Gestell anbringen oder sie warten.

Avvertenza Per evitare infortuni fisici durante il montaggio o la manutenzione di questa unità in un supporto, occorre osservare speciali precauzioni per garantire che il sistema rimanga stabile. Le seguenti direttive vengono fornite per garantire la sicurezza personale:

- Il Juniper Networks switch deve essere installato in un telaio, il quale deve essere fissato alla struttura dell'edificio.
- Questa unità deve venire montata sul fondo del supporto, se si tratta dell'unica unità da montare nel supporto.
- Quando questa unità viene montata in un supporto parzialmente pieno, caricare il supporto dal basso all'alto, con il componente più pesante sistemato sul fondo del supporto.
- Se il supporto è dotato di dispositivi stabilizzanti, installare tali dispositivi prima di montare o di procedere alla manutenzione dell'unità nel supporto.

Advarsel Unngå fysiske skader under montering eller reparasjonsarbeid på denne enheten når den befinner seg i et kabinett. Vær nøye med at systemet er stabilt. Følgende retningslinjer er gitt for å verne om sikkerheten:

- Juniper Networks switch må installeres i et stativ som er forankret til bygningsstrukturen.
- Denne enheten bør monteres nederst i kabinettet hvis dette er den eneste enheten i kabinettet.
- Ved montering av denne enheten i et kabinett som er delvis fylt, skal kabinettet lastes fra bunnen og opp med den tyngste komponenten nederst i kabinettet.
- Hvis kabinettet er utstyrt med stabiliseringsutstyr, skal stabilisatorene installeres før montering eller utføring av reparasjonsarbeid på enheten i kabinettet.

Aviso Para se prevenir contra danos corporais ao montar ou reparar esta unidade numa estante, deverá tomar precauções especiais para se certificar de que o sistema possui um suporte estável. As seguintes directrizes ajudá-lo-ão a efectuar o seu trabalho com segurança:

- O Juniper Networks switch deverá ser instalado numa prateleira fixa à estrutura do edifício.
- Esta unidade deverá ser montada na parte inferior da estante, caso seja esta a única unidade a ser montada.
- Ao montar esta unidade numa estante parcialmente ocupada, coloque os itens mais pesados na parte inferior da estante, arrumando-os de baixo para cima.
- Se a estante possuir um dispositivo de estabilização, instale-o antes de montar ou reparar a unidade.

¡Atención! Para evitar lesiones durante el montaje de este equipo sobre un bastidor, o posteriormente durante su mantenimiento, se debe poner mucho cuidado en que el sistema quede bien estable. Para garantizar su seguridad, proceda según las siguientes instrucciones:

- El Juniper Networks switch debe instalarse en un bastidor fijado a la estructura del edificio.
- Colocar el equipo en la parte inferior del bastidor, cuando sea la única unidad en el mismo.
- Cuando este equipo se vaya a instalar en un bastidor parcialmente ocupado, comenzar la instalación desde la parte inferior hacia la superior colocando el equipo más pesado en la parte inferior.
- Si el bastidor dispone de dispositivos estabilizadores, instalar éstos antes de montar o proceder al mantenimiento del equipo instalado en el bastidor.

Varning! För att undvika kroppsskada när du installerar eller utför underhållsarbete på denna enhet på en ställning måste du vidta särskilda försiktighetsåtgärder för att försäkra dig om att systemet står stadigt. Följande riktlinjer ges för att trygga din säkerhet:

- Juniper Networks switch måste installeras i en ställning som är förankrad i byggnadens struktur.
- Om denna enhet är den enda enheten på ställningen skall den installeras längst ned på ställningen.
- Om denna enhet installeras på en delvis fylld ställning skall ställningen fyllas nedifrån och upp, med de tyngsta enheterna längst ned på ställningen.
- Om ställningen är försedd med stabiliseringsdon skall dessa monteras fast innan enheten installeras eller underhålls på ställningen.

**Related
Documentation**

- [General Safety Guidelines and Warnings on page 145](#)
- [Installation Instructions Warning on page 155](#)
- [Grounded Equipment Warning on page 162](#)

- Mounting an EX2200 Switch
- Mounting an EX3200 Switch
- [Mounting an EX3300 Switch on page 82](#)
- Mounting an EX4200 Switch
- Mounting an EX4500 Switch
- Mounting an EX6210 Switch on a Rack or Cabinet
- Mounting an EX8208 Switch on a Rack or Cabinet
- Mounting an EX8216 Switch on a Rack or Cabinet
- Mounting a QFX3100 Director Device on Four Posts in a Rack or Cabinet
- Mounting a QFX3100 Director Device on Two Posts in a Rack or Cabinet
- Mounting a QFX3008-I Interconnect Device on a Rack or Cabinet Using a Mechanical Lift
- Mounting a QFX3500 Device in a Rack or Cabinet

Wall-Mounting Warning for EX3300 Switches



WARNING: When mounting an EX3300 switch chassis in a vertical position, orient the front panel of the chassis downward to ensure proper airflow and meet safety requirements in the event of a fire.

Related Documentation

- [Mounting an EX3300 Switch on a Wall on page 89](#)

Grounded Equipment Warning

This topic applies to hardware devices in the EX Series product family, which includes switches, the EX Series Redundant Power System (RPS), and the XRE200 External Routing Engine.

This topic also applies to hardware devices in the QFX Series.



WARNING: The device is intended to be grounded. During normal use, ensure that you have connected earth ground to the chassis.

Waarschuwing Deze apparatuur hoort geaard te worden. Zorg dat de host-computer tijdens normaal gebruik met aarde is verbonden.

Varoitus Tämä laitteisto on tarkoitettu maadoitettavaksi. Varmista, että isäntälaitte on yhdistetty maahan normaalikäytön aikana.

Attention Cet équipement doit être relié à la terre. S'assurer que l'appareil hôte est relié à la terre lors de l'utilisation normale.

Warnung Dieses Gerät muß geerdet werden. Stellen Sie sicher, daß das Host-Gerät während des normalen Betriebs an Erde gelegt ist.

Avvertenza Questa apparecchiatura deve essere collegata a massa. Accertarsi che il dispositivo host sia collegato alla massa di terra durante il normale utilizzo.

Advarsel Dette utstyret skal jordes. Forviss deg om vertsterminalen er jordet ved normalt bruk.

Aviso Este equipamento deverá estar ligado à terra. Certifique-se que o host se encontra ligado à terra durante a sua utilização normal.

¡Atención! Este equipo debe conectarse a tierra. Asegurarse de que el equipo principal esté conectado a tierra durante el uso normal.

Varning! Denna utrustning är avsedd att jordas. Se till att värdenheten är jordad vid normal användning.

Related Documentation • [General Safety Guidelines and Warnings on page 145](#)

Maintenance and Operational Safety Guidelines and Warnings

This topic applies to hardware devices in the EX Series product family, which includes switches, the EX Series Redundant Power System (RPS), and the XRE200 External Routing Engine.

This topic also applies to hardware devices in the QFX Series.

While performing the maintenance activities for devices, observe the following guidelines and warnings:

- [Battery Handling Warning on page 163](#)
- [Jewelry Removal Warning on page 164](#)
- [Lightning Activity Warning on page 166](#)
- [Operating Temperature Warning on page 166](#)
- [Product Disposal Warning on page 168](#)

Battery Handling Warning



WARNING: Replacing a battery incorrectly might result in an explosion. Replace a battery only with the same or equivalent type recommended by the manufacturer. Dispose of used batteries according to the manufacturer's instructions.

Waarschuwing Er is ontploffingsgevaar als de batterij verkeerd vervangen wordt. Vervang de batterij slechts met hetzelfde of een equivalent type dat door de fabrikant aanbevolen is. Gebruikte batterijen dienen overeenkomstig fabrieksvoorschriften weggeworpen te worden.

Varoitus Räjähdyksen vaara, jos akku on vaihdettu väärään akkuun. Käytä vaihtamiseen ainoastaan saman- tai vastaaventyypistä akkua, joka on valmistajan suosittama. Hävitä käytetyt akut valmistajan ohjeiden mukaan.

Attention Danger d'explosion si la pile n'est pas remplacée correctement. Ne la remplacer que par une pile de type semblable ou équivalent, recommandée par le fabricant. Jeter les piles usagées conformément aux instructions du fabricant.

Warnung Bei Einsetzen einer falschen Batterie besteht Explosionsgefahr. Ersetzen Sie die Batterie nur durch den gleichen oder vom Hersteller empfohlenen Batterietyp. Entsorgen Sie die benutzten Batterien nach den Anweisungen des Herstellers.

Advarsel Det kan være fare for eksplosjon hvis batteriet skiftes på feil måte. Skift kun med samme eller tilsvarende type som er anbefalt av produsenten. Kasser brukte batterier i henhold til produsentens instruksjoner.

Avvertenza Pericolo di esplosione se la batteria non è installata correttamente. Sostituire solo con una di tipo uguale o equivalente, consigliata dal produttore. Eliminare le batterie usate secondo le istruzioni del produttore.

Aviso Existe perigo de explosão se a bateria for substituída incorrectamente. Substitua a bateria por uma bateria igual ou de um tipo equivalente recomendado pelo fabricante. Destrua as baterias usadas conforme as instruções do fabricante.

¡Atención! Existe peligro de explosión si la batería se reemplaza de manera incorrecta. Reemplazar la batería exclusivamente con el mismo tipo o el equivalente recomendado por el fabricante. Desechar las baterías gastadas según las instrucciones del fabricante.

Varning! Explosionsfara vid felaktigt batteribyte. Ersätt endast batteriet med samma batterityp som rekommenderas av tillverkaren eller motsvarande. Följ tillverkarens anvisningar vid kassering av använda batterier.

Jewelry Removal Warning



WARNING: Before working on equipment that is connected to power lines, remove jewelry, including rings, necklaces, and watches. Metal objects heat up when connected to power and ground and can cause serious burns or can be welded to the terminals.

Waarschuwing Alvorens aan apparatuur te werken die met elektrische leidingen is verbonden, sieraden (inclusief ringen, kettingen en horloges) verwijderen. Metalen voorwerpen worden warm wanneer ze met stroom en aarde zijn verbonden, en kunnen ernstige brandwonden veroorzaken of het metalen voorwerp aan de aansluitklemmen lassen.

Varoitus Ennen kuin työskentelet voimavirtajohtoihin kytkettyjen laitteiden parissa, ota pois kaikki korut (sormukset, kaulakorut ja kellot mukaan lukien). Metalliesineet kuumenevat, kun ne ovat yhteydessä sähkövirran ja maan kanssa, ja ne voivat aiheuttaa vakavia palovammoja tai hitsata metalliesineet kiinni liitäntänapoihin.

Attention Avant d'accéder à cet équipement connecté aux lignes électriques, ôter tout bijou (anneaux, colliers et montres compris). Lorsqu'ils sont branchés à l'alimentation et reliés à la terre, les objets métalliques chauffent, ce qui peut provoquer des blessures graves ou souder l'objet métallique aux bornes.

Warnung Vor der Arbeit an Geräten, die an das Netz angeschlossen sind, jeglichen Schmuck (einschließlich Ringe, Ketten und Uhren) abnehmen. Metallgegenstände erhitzen sich, wenn sie an das Netz und die Erde angeschlossen werden, und können schwere Verbrennungen verursachen oder an die Anschlußklemmen angeschweißt werden.

Avvertenza Prima di intervenire su apparecchiature collegate alle linee di alimentazione, togliersi qualsiasi monile (inclusi anelli, collane, braccialetti ed orologi). Gli oggetti metallici si riscaldano quando sono collegati tra punti di alimentazione e massa: possono causare ustioni gravi oppure il metallo può saldarsi ai terminali.

Advarsel Fjern alle smykker (inkludert ringer, halskjeder og klokker) før du skal arbeide på utstyr som er koblet til kraftledninger. Metallgjenstander som er koblet til kraftledninger og jord blir svært varme og kan forårsake alvorlige brannskader eller smelte fast til polene.

Aviso Antes de trabalhar em equipamento que esteja ligado a linhas de corrente, retire todas as jóias que estiver a usar (incluindo anéis, fios e relógios). Os objectos metálicos aquecerão em contacto com a corrente e em contacto com a ligação à terra, podendo causar queimaduras graves ou ficarem soldados aos terminais.

¡Atención! Antes de operar sobre equipos conectados a líneas de alimentación, quitarse las joyas (incluidos anillos, collares y relojes). Los objetos de metal se calientan cuando se conectan a la alimentación y a tierra, lo que puede ocasionar quemaduras graves o que los objetos metálicos queden soldados a los bornes.

Varning! Tag av alla smycken (inklusive ringar, halsband och armbandsur) innan du arbetar på utrustning som är kopplad till kraftledningar. Metallobjekt hettas upp när de kopplas ihop med ström och jord och kan förorsaka

allvarliga brännskador; metallobjekt kan också sammansvetsas med kontakterna.

Lightning Activity Warning



WARNING: Do not work on the system or connect or disconnect cables during periods of lightning activity.

Waarschuwing Tijdens onweer dat gepaard gaat met bliksem, dient u niet aan het systeem te werken of kabels aan te sluiten of te ontkoppelen.

Varoitus Älä työskentele järjestelmän parissa äläkä yhdistä tai irrota kaapeleita ukkosilmalla.

Attention Ne pas travailler sur le système ni brancher ou débrancher les câbles pendant un orage.

Warnung Arbeiten Sie nicht am System und schließen Sie keine Kabel an bzw. trennen Sie keine ab, wenn es gewittert.

Avvertenza Non lavorare sul sistema o collegare oppure scollegare i cavi durante un temporale con fulmini.

Advarsel Utfør aldri arbeid på systemet, eller koble kabler til eller fra systemet når det tordner eller lyner.

Aviso Não trabalhe no sistema ou ligue e desligue cabos durante períodos de mau tempo (trovoada).

¡Atención! No operar el sistema ni conectar o desconectar cables durante el transcurso de descargas eléctricas en la atmósfera.

Varning! Vid åska skall du aldrig utföra arbete på systemet eller ansluta eller koppla loss kablar.

Operating Temperature Warning



WARNING: To prevent the device from overheating, do not operate it in an area that exceeds the maximum recommended ambient temperature of 104° F (40° C) for EX6200 switches, EX8208 switches, EX8216 switches, QFX Series devices, and XRE200 External Routing Engines and 113° F (45° C) for EX2200, EX3300, EX3200, EX4200, and EX4500 switches. To prevent airflow restriction, allow at least 6 in. (15.2 cm) of clearance around the ventilation openings.

Waarschuwing Om te voorkomen dat welke switch van de Juniper Networks router dan ook oververhit raakt, dient u deze niet te bedienen op een plaats

waar de maximale aanbevolen omgevingstemperatuur van 40° C wordt overschreden. Om te voorkomen dat de luchtstroom wordt beperkt, dient er minstens 15,2 cm speling rond de ventilatie-openingen te zijn.

Varoitus Ettei Juniper Networks switch-sarjan reititin ylikuumentuusi, sitä ei saa käyttää tilassa, jonka lämpötila ylittää korkeimman suositellun ympäristölämpötilan 40° C. Ettei ilmanvaihto estyisi, tuuletusaukkojen ympärille on jätettävä ainakin 15,2 cm tilaa.

Attention Pour éviter toute surchauffe des routeurs de la gamme Juniper Networks switch, ne l'utilisez pas dans une zone où la température ambiante est supérieure à 40° C. Pour permettre un flot d'air constant, dégagez un espace d'au moins 15,2 cm autour des ouvertures de ventilations.

Warnung Um einen Router der switch vor Überhitzung zu schützen, darf dieser nicht in einer Gegend betrieben werden, in der die Umgebungstemperatur das empfohlene Maximum von 40° C überschreitet. Um Lüftungsverschluß zu verhindern, achten Sie darauf, daß mindestens 15,2 cm lichter Raum um die Lüftungsöffnungen herum frei bleibt.

Avvertenza Per evitare il surriscaldamento dei switch, non adoperateli in un locale che ecceda la temperatura ambientale massima di 40° C. Per evitare che la circolazione dell'aria sia impedita, lasciate uno spazio di almeno 15.2 cm di fronte alle aperture delle ventole.

Advarsel Unngå overoppheting av eventuelle rutere i Juniper Networks switch. Disse skal ikke brukes på steder der den anbefalte maksimale omgivelsestemperaturen overstiger 40° C (104° F). Sørg for at klaringen rundt lufteåpningene er minst 15,2 cm (6 tommer) for å forhindre nedsatt luftsirkulasjon.

Aviso Para evitar o sobreaquecimento do encaminhador Juniper Networks switch, não utilize este equipamento numa área que exceda a temperatura máxima recomendada de 40° C. Para evitar a restrição à circulação de ar, deixe pelo menos um espaço de 15,2 cm à volta das aberturas de ventilação.

¡Atención! Para impedir que un encaminador de la serie Juniper Networks switch se recaliente, no lo haga funcionar en un área en la que se supere la temperatura ambiente máxima recomendada de 40° C. Para impedir la restricción de la entrada de aire, deje un espacio mínimo de 15,2 cm alrededor de las aperturas para ventilación.

Varning! Förhindra att en Juniper Networks switch överhettas genom att inte använda den i ett område där den maximalt rekommenderade omgivningstemperaturen på 40° C överskrids. Förhindra att luftcirkulationen inskränks genom att se till att det finns fritt utrymme på minst 15,2 cm omkring ventilationsöppningarna.

Product Disposal Warning



WARNING: Disposal of this device must be handled according to all national laws and regulations.

Waarschuwing Dit produkt dient volgens alle landelijke wetten en voorschriften te worden afgedankt.

Varoitus Tämän tuotteen lopullisesta hävittämisestä tulee huolehtia kaikkia valtakunnallisia lakeja ja säännöksiä noudattaen.

Attention La mise au rebut définitive de ce produit doit être effectuée conformément à toutes les lois et réglementations en vigueur.

Warnung Dieses Produkt muß den geltenden Gesetzen und Vorschriften entsprechend entsorgt werden.

Avvertenza L'eliminazione finale di questo prodotto deve essere eseguita osservando le normative italiane vigenti in materia

Advarsel Endelig disponering av dette produktet må skje i henhold til nasjonale lover og forskrifter.

Aviso A descartagem final deste produto deverá ser efectuada de acordo com os regulamentos e a legislação nacional.

¡Atención! El desecho final de este producto debe realizarse según todas las leyes y regulaciones nacionales

Varning! Slutlig kassering av denna produkt bör skötas i enlighet med landets alla lagar och föreskrifter.

Related Documentation

- [General Safety Guidelines and Warnings on page 145](#)
- [General Electrical Safety Guidelines and Warnings on page 169](#)
- [AC Power Electrical Safety Guidelines on page 172](#)
- [DC Power Electrical Safety Guidelines on page 175](#)
- [Laser and LED Safety Guidelines and Warnings for EX Series Switches on page 151](#)
- [Laser and LED Safety Guidelines and Warnings for the QFX Series](#)
- [Installation Instructions Warning on page 155](#)
- [Grounded Equipment Warning on page 162](#)

Power and Electrical Safety Information

- General Electrical Safety Guidelines and Warnings on page 169
- Prevention of Electrostatic Discharge Damage on page 170
- AC Power Electrical Safety Guidelines on page 172
- AC Power Disconnection Warning on page 174
- DC Power Electrical Safety Guidelines on page 175
- DC Power Disconnection Warning on page 176
- DC Power Grounding Requirements and Warning on page 178
- DC Power Wiring Sequence Warning on page 179
- DC Power Wiring Terminations Warning on page 181
- TN Power Warning on page 182
- Action to Take After an Electrical Accident on page 183

General Electrical Safety Guidelines and Warnings

This topic applies to hardware devices in the EX Series product family, which includes switches, the EX Series Redundant Power System (RPS), and the XRE200 External Routing Engine.

This topic also applies to hardware devices in the QFX Series.



WARNING: Certain ports on the device are designed for use as intrabuilding (within-the-building) interfaces only (Type 2 or Type 4 ports as described in GR-1089-CORE, Issue 4) and require isolation from the exposed outside plant (OSP) cabling. To comply with NEBS requirements and protect against lightning surges and commercial power disturbances, the intrabuilding ports *must not* be metallically connected to interfaces that connect to the OSP or its wiring. The intrabuilding ports on the device are suitable for connection to intrabuilding or unexposed wiring or cabling only. The addition of primary protectors is not sufficient protection for connecting these interfaces metallically to OSP wiring.



CAUTION: Before removing or installing components of a device, attach an ESD grounding strap to an ESD point and place the other end of the strap around your bare wrist. Failure to use an ESD grounding strap could result in damage to the switch.

- Install the device in compliance with the following local, national, and international electrical codes:
 - United States—National Fire Protection Association (NFPA 70), United States National Electrical Code.
 - Other countries—International Electromechanical Commission (IEC) 60364, Part 1 through Part 7.
 - Evaluated to the TN power system.
 - Canada—Canadian Electrical Code, Part 1, CSA C22.1.
- Locate the emergency power-off switch for the room in which you are working so that if an electrical accident occurs, you can quickly turn off the power.
- Make sure that grounding surfaces are cleaned and brought to a bright finish before grounding connections are made.
- Do not work alone if potentially hazardous conditions exist anywhere in your workspace.
- Never assume that power is disconnected from a circuit. Always check the circuit before starting to work.
- Carefully look for possible hazards in your work area, such as moist floors, ungrounded power extension cords, and missing safety grounds.
- Operate the device within marked electrical ratings and product usage instructions.
- To ensure that the device and peripheral equipment function safely and correctly, use the cables and connectors specified for the attached peripheral equipment, and make certain they are in good condition.

You can remove and replace many device components without powering off or disconnecting power to the device, as detailed elsewhere in the hardware documentation for this device. Never install equipment if it appears damaged.

Related Documentation

- [General Safety Guidelines and Warnings on page 145](#)
- [AC Power Electrical Safety Guidelines on page 172](#)
- [DC Power Electrical Safety Guidelines on page 175](#)

Prevention of Electrostatic Discharge Damage

This topic applies to hardware devices in the EX Series product family, which includes switches, the EX Series Redundant Power System (RPS), and the XRE200 External Routing Engine.

This topic also applies to hardware devices in the QFX Series.

Device components that are shipped in antistatic bags are sensitive to damage from static electricity. Some components can be impaired by voltages as low as 30 V. You can easily generate potentially damaging static voltages whenever you handle plastic or foam packing material or if you move components across plastic or carpets. Observe the following guidelines to minimize the potential for electrostatic discharge (ESD) damage, which can cause intermittent or complete component failures:

- Always use an ESD grounding strap when you are handling components that are subject to ESD damage, and make sure that it is in direct contact with your skin.

If a grounding strap is not available, hold the component in its antistatic bag (see [Figure 46 on page 171](#)) in one hand and touch the exposed, bare metal of the device with the other hand immediately before inserting the component into the device.



WARNING: For safety, periodically check the resistance value of the ESD grounding strap. The measurement must be in the range 1 through 10 Mohms.

- When handling any component that is subject to ESD damage and that is removed from the device, make sure the equipment end of your ESD grounding strap is attached to the ESD point on the chassis.

If no grounding strap is available, touch the exposed, bare metal of the device to ground yourself before handling the component.

- Avoid contact between the component that is subject to ESD damage and your clothing. ESD voltages emitted from clothing can damage components.
- When removing or installing a component that is subject to ESD damage, always place it component-side up on an antistatic surface, in an antistatic card rack, or in an antistatic bag (see [Figure 46 on page 171](#)). If you are returning a component, place it in an antistatic bag before packing it.

Figure 46: Place a Component into an Antistatic Bag

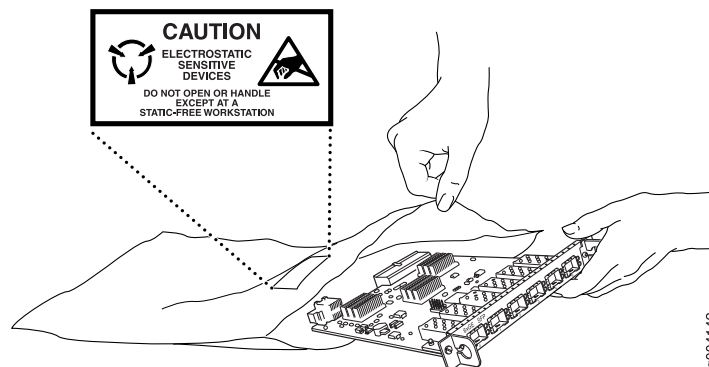



CAUTION: ANSI/TIA/EIA-568 cables such as Category 5e and Category 6 can get electrostatically charged. To dissipate this charge, always ground the cables to a suitable and safe earth ground before connecting them to the system.

Related Documentation

- [General Safety Guidelines and Warnings on page 145](#)
- See EX2200 Switches Hardware Overview for the ESD point location.
- See Rear Panel of an EX3200 Switch for the ESD point location.
- See [Rear Panel of an EX3300 Switch on page 7](#) for the ESD point location.
- See Rear Panel of an EX4200 Switch for the ESD point location.
- See Front Panel of an EX4500 Switch for the ESD point location.
- See Chassis Physical Specifications of an EX6210 Switch for the ESD point location.
- See Chassis Physical Specifications of an EX8208 Switch for the ESD point location.
- See Chassis Physical Specifications of an EX8216 Switch for the ESD point location.
- See QFX3008-I Interconnect Device Overview for the ESD point location.
- See Front Panel of a QFX3500 Device for the ESD point location.
- See Front Panel of a QFX3600 Node Device for the ESD point location.
- Physical Description of a Redundant Power System

AC Power Electrical Safety Guidelines

This topic applies to hardware devices in the EX Series product family, which includes switches, the EX Series Redundant Power System (RPS), and the XRE200 External Routing Engine.

This topic also applies to hardware devices in the QFX Series.



CAUTION: For devices with AC power supplies, an external surge protective device (SPD) must be used at the AC power source.

The following electrical safety guidelines apply to AC-powered devices:

- Note the following warnings printed on the device:
 - “**CAUTION:** THIS UNIT HAS MORE THAN ONE POWER SUPPLY CORD. DISCONNECT ALL POWER SUPPLY CORDS BEFORE SERVICING TO AVOID ELECTRIC SHOCK.”
 - “**ATTENTION:** CET APPAREIL COMPORTE PLUS D'UN CORDON D'ALIMENTATION. AFIN DE PRÉVENIR LES CHOCS ÉLECTRIQUES, DÉBRANCHER TOUT CORDON D'ALIMENTATION AVANT DE FAIRE LE DÉPANNAGE.”
- AC-powered devices are shipped with a three-wire electrical cord with a grounding-type plug that fits only a grounding-type power outlet. Do not circumvent this safety feature. Equipment grounding must comply with local and national electrical codes.
- You must provide an external certified circuit breaker rated minimum 20 A in the building installation.
- The power cord serves as the main disconnecting device for the AC-powered device. The socket outlet must be near the AC-powered device and be easily accessible.
- For devices that have more than one power supply connection, you must ensure that all power connections are fully disconnected so that power to the device is completely removed to avoid electric shock. To disconnect power, unplug all power cords (one for each power supply).

Power Cable Warning (Japanese)

WARNING: The attached power cable is only for this product. Do not use the cable for another product.

注意

附属の電源コードセットはこの製品専用です。
他の電気機器には使用しないでください。

9017253

Related Documentation

- [General Safety Guidelines and Warnings on page 145](#)
- [General Electrical Safety Guidelines and Warnings on page 169](#)
- [Multiple Power Supplies Disconnection Warning](#)
- [Connecting AC Power to an EX2200 Switch](#)
- [Connecting AC Power to an EX3200 Switch](#)
- [Connecting AC Power to an EX3300 Switch on page 102](#)
- [Connecting AC Power to an EX4200 Switch](#)
- [Connecting AC Power to an EX4500 Switch](#)
- [Connecting AC Power to an EX6200 Switch](#)
- [Connecting AC Power to an EX8200 Switch](#)

- Connecting AC Power to an XRE200 External Routing Engine
- Connecting AC Power to a QFX3100 Director Device
- Connecting AC Power to a QFX3008-I Interconnect Device with Single-Phase Wiring Trays
- Connecting AC Power to a QFX3008-I Interconnect Device with Three-Phase Delta Wiring Trays
- Connecting AC Power to a QFX3008-I Interconnect Device with Three-Phase Wye Wiring Trays
- Connecting AC Power to a QFX3500, QFX3600, or QFX3600-I Device

AC Power Disconnection Warning

This topic applies to hardware devices in the EX Series product family, which includes switches, the EX Series Redundant Power System (RPS), and the XRE200 External Routing Engine.

This topic also applies to hardware devices in the QFX Series.



WARNING: Before working on the switch or near power supplies, unplug all the power cords from an AC switch.

Waarschuwing Voordat u aan een frame of in de nabijheid van voedingen werkt, dient u bij wisselstroom toestellen de stekker van het netsnoer uit het stopcontact te halen.

Varoitus Kytke irti vaihtovirtalaitteiden virtajohto, ennen kuin teet mitään asennuspohjalle tai työskentelet virtalähteiden läheisyydessä.

Attention Avant de travailler sur un châssis ou à proximité d'une alimentation électrique, débrancher le cordon d'alimentation des unités en courant alternatif.

Warnung Bevor Sie an einem Chassis oder in der Nähe von Netzgeräten arbeiten, ziehen Sie bei Wechselstromeinheiten das Netzkabel ab bzw.

Avvertenza Prima di lavorare su un telaio o intorno ad alimentatori, scollegare il cavo di alimentazione sulle unità CA.

Advarsel Før det utføres arbeid på kabinettet eller det arbeides i nærheten av strømforsyningsenheter, skal strømledningen trekkes ut på vekselstrømsenheter.

Aviso Antes de trabalhar num chassis, ou antes de trabalhar perto de unidades de fornecimento de energia, desligue o cabo de alimentação nas unidades de corrente alternada.

¡Atención! Antes de manipular el chasis de un equipo o trabajar cerca de una fuente de alimentación, desenchufar el cable de alimentación en los equipos de corriente alterna (CA).

Varning! Innan du arbetar med ett chassi eller nära strömförsörjningsenheter skall du för växelströmsenheter dra ur nätsladden.

Related Documentation

- [General Safety Guidelines and Warnings on page 145](#)
- [General Electrical Safety Guidelines and Warnings on page 169](#)
- [AC Power Electrical Safety Guidelines on page 172](#)

DC Power Electrical Safety Guidelines

This topic applies to hardware devices in the EX Series product family, which includes switches and the XRE200 External Routing Engine.

This topic also applies to hardware devices in the QFX Series.

- A DC-powered device is equipped with a DC terminal block that is rated for the power requirements of a maximally configured device.



NOTE: To supply sufficient power, terminate the DC input wiring on a facility DC source that is capable of supplying:

- Minimum of 7.5 A at –48 VDC for EX2200 and EX3300 switches
- Minimum of 8 A at –48 VDC for EX3200 and EX4200 switches
- Minimum of 50 A at –48 VDC for EX6210 switches
- Minimum of 60 A at –48 VDC for EX8208 switches
- Minimum of 100 A at –48 VDC for EX8216 switches
- Minimum of 7 A at –48 VDC for QFX3500 devices
- Minimum of 8 A at –48 VDC for QFX3600 devices

Incorporate an easily accessible disconnect device into the facility wiring. Be sure to connect the ground wire or conduit to a solid office earth ground. A closed loop ring is recommended for terminating the ground conductor at the ground stud.

- Run two wires from the circuit breaker box to a source of 48 VDC.
- A DC-powered device that is equipped with a DC terminal block is intended only for installation in a restricted access location. In the United States, a restricted access area is one in accordance with Articles 110-16, 110-17, and 110-18 of the National Electrical Code ANSI/NFPA 70.



NOTE: Primary overcurrent protection is provided by the building circuit breaker. This breaker must protect against excess currents, short circuits, and earth grounding faults in accordance with NEC ANSI/NFPA 70.

- Ensure that the polarity of the DC input wiring is correct. Under certain conditions, connections with reversed polarity might trip the primary circuit breaker or damage the equipment.
- For personal safety, connect the green and yellow wire to safety (earth) ground at both the device and the supply side of the DC wiring.
- The marked input voltage of –48 VDC for a DC-powered device is the nominal voltage associated with the battery circuit, and any higher voltages are only to be associated with float voltages for the charging function.
- Because the device is a positive ground system, you must connect the positive lead to the terminal labeled RTN, the negative lead to the terminal labeled –48 VDC, and the earth ground to the device grounding points.

**Related
Documentation**

- [General Safety Guidelines and Warnings on page 145](#)
- [General Electrical Safety Guidelines and Warnings on page 169](#)
- [DC Power Disconnection Warning on page 176](#)
- [DC Power Grounding Requirements and Warning on page 178](#)
- [DC Power Wiring Sequence Warning on page 179](#)
- [DC Power Wiring Terminations Warning on page 181](#)
- [Connecting DC Power to an EX2200 Switch](#)
- [Connecting DC Power to an EX3200 Switch](#)
- [Connecting DC Power to an EX4200 Switch](#)
- [Connecting DC Power to an EX4500 Switch](#)
- [Connecting DC Power to an EX6200 Switch](#)
- [Connecting DC Power to an EX8200 Switch](#)
- [Connecting DC Power to an XRE200 External Routing Engine](#)
- [Connecting DC Power to a QFX3500, QFX3600, or QFX3600-I Device](#)

DC Power Disconnection Warning

This topic applies to hardware devices in the EX Series product family, which includes switches and the XRE200 External Routing Engine.

This topic also applies to hardware devices in the QFX Series.



WARNING: Before performing any of the DC power procedures, ensure that power is removed from the DC circuit. To ensure that all power is off, locate the circuit breaker on the panel board that services the DC circuit, switch the circuit breaker to the OFF position, and tape the device handle of the circuit breaker in the OFF position.

Waarschuwing Voordat u een van de onderstaande procedures uitvoert, dient u te controleren of de stroom naar het gelijkstroom circuit uitgeschakeld is. Om u ervan te verzekeren dat alle stroom UIT is geschakeld, kiest u op het schakelbord de stroomverbreker die het gelijkstroom circuit bedient, draait de stroomverbreker naar de UIT positie en plakt de schakelaarhendel van de stroomverbreker met plakband in de UIT positie vast.

Varoitus Varmista, että tasavirtapiirissä ei ole virtaa ennen seuraavien toimenpiteiden suorittamista. Varmistaaksesi, että virta on KATKAISTU täysin, paikanna tasavirrasta huolehtivassa kojetaulussa sijaitseva suojakytkin, käännä suojakytkin KATKAISTU-asentoon ja teippaa suojakytkimen varsi niin, että se pysyy KATKAISTU-asennossa.

Attention Avant de pratiquer l'une quelconque des procédures ci-dessous, vérifiez que le circuit en courant continu n'est plus sous tension. Pour en être sûr, localiser le disjoncteur situé sur le panneau de service du circuit en courant continu, placer le disjoncteur en position fermée (OFF) et, à l'aide d'un ruban adhésif, bloquer la poignée du disjoncteur en position OFF.

Warnung Vor Ausführung der folgenden Vorgänge ist sicherzustellen, daß die Gleichstromschaltung keinen Strom erhält. Um sicherzustellen, daß sämtlicher Strom abgestellt ist, machen Sie auf der Schalttafel den Unterbrecher für die Gleichstromschaltung ausfindig, stellen Sie den Unterbrecher auf AUS, und kleben Sie den Schaltergriff des Unterbrechers mit Klebeband in der AUS-Stellung fest.

Avvertenza Prima di svolgere una qualsiasi delle procedure seguenti, verificare che il circuito CC non sia alimentato. Per verificare che tutta l'alimentazione sia scollegata (OFF), individuare l'interruttore automatico sul quadro strumenti che alimenta il circuito CC, mettere l'interruttore in posizione OFF e fissarlo con nastro adesivo in tale posizione.

Advarsel Før noen av disse prosedyrene utføres, kontroller at strømmen er frakoblet likestrømkretsen. Sørg for at all strøm er slått AV. Dette gjøres ved å lokalisere strømbryteren på brytertavlen som betjener likestrømkretsen, slå strømbryteren AV og teipe bryterhåndtaket på strømbryteren i AV-stilling.

Aviso Antes de executar um dos seguintes procedimentos, certifique-se que desligou a fonte de alimentação de energia do circuito de corrente contínua. Para se assegurar que toda a corrente foi DESLIGADA, localize o disjuntor no painel que serve o circuito de corrente contínua e coloque-o na posição OFF (Desligado), segurando nessa posição a manivela do interruptor do disjuntor com fita isoladora.

¡Atención! Antes de proceder con los siguientes pasos, comprobar que la alimentación del circuito de corriente continua (CC) esté cortada (OFF). Para asegurarse de que toda la alimentación esté cortada (OFF), localizar el interruptor automático en el panel que alimenta al circuito de corriente continua, cambiar el interruptor automático a la posición de Apagado (OFF), y sujetar con cinta la palanca del interruptor automático en posición de Apagado (OFF).

Varning! Innan du utför någon av följande procedurer måste du kontrollera att strömförsörjningen till likströmskretsen är bruten. Kontrollera att all strömförsörjning är BRUTEN genom att slå AV det överspänningsskydd som skyddar likströmskretsen och tejpa fast överspänningsskyddets omkopplare i FRÅN-läget.

Related Documentation

- [General Safety Guidelines and Warnings on page 145](#)
- [General Electrical Safety Guidelines and Warnings on page 169](#)
- [DC Power Electrical Safety Guidelines on page 175](#)
- [DC Power Grounding Requirements and Warning on page 178](#)
- [DC Power Wiring Sequence Warning on page 179](#)
- [DC Power Wiring Terminations Warning on page 181](#)

DC Power Grounding Requirements and Warning

This topic applies to hardware devices in the EX Series product family, which includes switches and the XRE200 External Routing Engine.

This topic also applies to hardware devices in the QFX Series.

An insulated grounding conductor that is identical in size to the grounded and ungrounded branch circuit supply conductors but is identifiable by green and yellow stripes is installed as part of the branch circuit that supplies the device. The grounding conductor is a separately derived system at the supply transformer or motor generator set.



WARNING: When you install the device, the ground connection must always be made first and disconnected last.

Waarschuwing Bij de installatie van het toestel moet de aardverbinding altijd het eerste worden gemaakt en het laatste worden losgemaakt.

Varoitus Laitetta asennettaessa on maahan yhdistäminen aina tehtävä ensiksi ja maadoituksen irti kytkeminen viimeiseksi.

Attention Lors de l'installation de l'appareil, la mise à la terre doit toujours être connectée en premier et déconnectée en dernier.

Warnung Der Erdanschluß muß bei der Installation der Einheit immer zuerst hergestellt und zuletzt abgetrennt werden.

Avvertenza In fase di installazione dell'unità, eseguire sempre per primo il collegamento a massa e disconnetterlo per ultimo.

Advarsel Når enheten installeres, må jordledningen alltid tilkobles først og frakobles sist.

Aviso Ao instalar a unidade, a ligação à terra deverá ser sempre a primeira a ser ligada, e a última a ser desligada.

¡Atención! Al instalar el equipo, conectar la tierra la primera y desconectarla la última.

Varning! Vid installation av enheten måste jordledningen alltid anslutas först och kopplas bort sist.

Related Documentation

- [General Safety Guidelines and Warnings on page 145](#)
- [General Electrical Safety Guidelines and Warnings on page 169](#)
- [DC Power Electrical Safety Guidelines on page 175](#)
- [DC Power Disconnection Warning on page 176](#)
- [DC Power Wiring Sequence Warning on page 179](#)
- [DC Power Wiring Terminations Warning on page 181](#)

DC Power Wiring Sequence Warning

This topic applies to hardware devices in the EX Series product family, which includes switches and the XRE200 External Routing Engine.

This topic also applies to hardware devices in the QFX Series.



WARNING: Wire the DC power supply using the appropriate lugs. When connecting power, the proper wiring sequence is ground to ground, +RTN to +RTN, then –48 V to –48 V. When disconnecting power, the proper wiring sequence is –48 V to –48 V, +RTN to +RTN, then ground to ground. Note that the ground wire must always be connected first and disconnected last.

Waarschuwing De juiste bedradingsvolgorde verbonden is aarde naar aarde, +RTN naar +RTN, en –48 V naar –48 V. De juiste bedradingsvolgorde losgemaakt is en –48 naar –48 V, +RTN naar +RTN, aarde naar aarde.

Varoitus Oikea yhdistettävä kytkentäjäryhitys on maajohto maajohtoon, +RTN varten +RTN, –48 V varten –48 V. Oikea irrotettava kytkentäjäryhitys on –48 V varten –48 V, +RTN varten +RTN, maajohto maajohtoon.

Attention Câblez l'alimentation d'alimentation CC En utilisant les crochets appropriés à l'extrémité de câblage. En reliant la puissance, l'ordre approprié de câblage est rectifié pour rectifier, +RTN à +RTN, puis -48 V à -48 V. En débranchant la puissance, l'ordre approprié de câblage est -48 V à -48 V, +RTN à +RTN, a alors rectifié pour rectifier. Notez que le fil de masse devrait toujours être relié d'abord et débranché pour la dernière fois. Notez que le fil de masse devrait toujours être relié d'abord et débranché pour la dernière fois.

Warnung Die Stromzufuhr ist nur mit geeigneten Ringösen an das DC Netzteil anzuschliessen. Die richtige Anschlusssequenz ist: Erdanschluss zu Erdanschluss, +RTN zu +RTN und dann -48V zu -48V. Die richtige Sequenz zum Abtrennen der Stromversorgung ist -48V zu -48V, +RTN zu +RTN und dann Erdanschluss zu Erdanschluss. Es ist zu beachten dass der Erdanschluss immer zuerst angeschlossen und als letztes abgetrennt wird.

Avvertenza Mostra la morsettiera dell'alimentatore CC. Cablare l'alimentatore CC usando i connettori adatti all'estremità del cablaggio, come illustrato. La corretta sequenza di cablaggio è da massa a massa, da positivo a positivo (da linea ad L) e da negativo a negativo (da neutro a N). Tenere presente che il filo di massa deve sempre venire collegato per primo e scollegato per ultimo.

Advarsel Riktig tilkoples tilkoplingssekvens er jord til jord, +RTN til +RTN, -48 V til -48 V. Riktig frakoples tilkoplingssekvens er -48 V til -48 V, +RTN til +RTN, jord til jord.

Aviso Ate con alambre la fuente de potencia cc Usando los terminales apropiados en el extremo del cableado. Al conectar potencia, la secuencia apropiada del cableado se muele para moler, +RTN a +RTN, entonces -48 V a -48 V. Al desconectar potencia, la secuencia apropiada del cableado es -48 V a -48 V, +RTN a +RTN, entonces molió para moler. Observe que el alambre de tierra se debe conectar siempre primero y desconectar por último. Observe que el alambre de tierra se debe conectar siempre primero y desconectar por último.

Atenção! Wire a fonte de alimentação de DC Usando os talões apropriados na extremidade da fiação. Ao conectar a potência, a seqüência apropriada da fiação é moída para moer, +RTN a +RTN, então -48 V a -48 V. Ao desconectar a potência, a seqüência apropriada da fiação é -48 V a -48 V, +RTN a +RTN, moeu então para moer. Anote que o fio à terra deve sempre ser conectado primeiramente e desconectado por último. Anote que o fio à terra deve sempre ser conectado primeiramente e desconectado por último.

Varning! Korrekt kopplingssekvens ar jord till jord, +RTN till +RTN, -48 V till -48 V. Korrekt kopplas kopplingssekvens ar -48 V till -48 V, +RTN till +RTN, jord till jord.

Related Documentation • [General Safety Guidelines and Warnings on page 145](#)

- [General Electrical Safety Guidelines and Warnings on page 169](#)
- [DC Power Electrical Safety Guidelines on page 175](#)
- [DC Power Disconnection Warning on page 176](#)
- [DC Power Grounding Requirements and Warning on page 178](#)
- [DC Power Wiring Terminations Warning on page 181](#)

DC Power Wiring Terminations Warning

This topic applies to hardware devices in the EX Series product family, which includes switches and the XRE200 External Routing Engine.

This topic also applies to hardware devices in the QFX Series.



WARNING: When stranded wiring is required, use approved wiring terminations, such as closed-loop or spade-type with upturned lugs. These terminations must be the appropriate size for the wires and must clamp both the insulation and conductor.

Waarschuwing Wanneer geslagen bedrading vereist is, dient u bedrading te gebruiken die voorzien is van goedgekeurde aansluitingspunten, zoals het gesloten-lus type of het grijperschop type waarbij de aansluitpunten omhoog wijzen. Deze aansluitpunten dienen de juiste maat voor de draden te hebben en dienen zowel de isolatie als de geleider vast te klemmen.

Varoitus Jos säikeellinen johdin on tarpeen, käytä hyväksyttyä johdinliitäntää, esimerkiksi suljettua silmukkaa tai kourumaista liitäntää, jossa on ylöspäin käännetyt kiinnityskorvat. Tällaisten liitäntöjen tulee olla kooltaan johtimiin sopivia ja niiden tulee puristaa yhteen sekä eristeen että johdinosan.

Attention Quand des fils torsadés sont nécessaires, utiliser des douilles terminales homologuées telles que celles à circuit fermé ou du type à plage ouverte avec cosses rebroussées. Ces douilles terminales doivent être de la taille qui convient aux fils et doivent être refermées sur la gaine isolante et sur le conducteur.

Warnung Wenn Litzenverdrahtung erforderlich ist, sind zugelassene Verdrahtungsabschlüsse, z.B. für einen geschlossenen Regelkreis oder gabelförmig, mit nach oben gerichteten Kabelschuhen zu verwenden. Diese Abschlüsse sollten die angemessene Größe für die Drähte haben und sowohl die Isolierung als auch den Leiter festklemmen.

Avvertenza Quando occorre usare trecce, usare connettori omologati, come quelli a occhiello o a forcilla con linguette rivolte verso l'alto. I connettori devono avere la misura adatta per il cablaggio e devono serrare sia l'isolante che il conduttore.

Advarsel Hvis det er nødvendig med flertrådede ledninger, bruges godkendte ledningsafslutninger, som for eksempel lukket sløfje eller spadetype med oppoverbøjede kabelsko. Disse afslutningene skal ha riktig størrelse i forhold til ledningene, og skal klemme sammen både isolasjonen og ledaren.

Aviso Quando forem requeridas montagens de instalação eléctrica de cabo torcido, use terminações de cabo aprovadas, tais como, terminações de cabo em circuito fechado e planas com terminais de orelha voltados para cima. Estas terminações de cabo deverão ser do tamanho apropriado para os respectivos cabos, e deverão prender simultaneamente o isolamento e o fio condutor.

¡Atención! Cuando se necesite hilo trenzado, utilizar terminales para cables homologados, tales como las de tipo "bucle cerrado" o "espada", con las lengüetas de conexión vueltas hacia arriba. Estos terminales deberán ser del tamaño apropiado para los cables que se utilicen, y tendrán que sujetar tanto el aislante como el conductor.

Varning! När flertrådiga ledningar krävs måste godkända ledningskontakter användas, t.ex. kabelsko av sluten eller öppen typ med uppåtvänd tapp. Storleken på dessa kontakter måste vara avpassad till ledningarna och måste kunna hålla både isoleringen och ledaren fastklämda.

Related Documentation

- [General Safety Guidelines and Warnings on page 145](#)
- [General Electrical Safety Guidelines and Warnings on page 169](#)
- [DC Power Electrical Safety Guidelines on page 175](#)
- [DC Power Disconnection Warning on page 176](#)
- [DC Power Grounding Requirements and Warning on page 178](#)
- [DC Power Wiring Sequence Warning on page 179](#)

TN Power Warning

This topic applies to hardware devices in the EX Series product family, which includes switches, the EX Series Redundant Power System (RPS), and the XRE200 External Routing Engine.

This topic also applies to hardware devices in the QFX Series.



WARNING: The device is designed to work with a TN power system.

Waarschuwing Het apparaat is ontworpen om te functioneren met TN energiesystemen.

Varoitus Koje on suunniteltu toimimaan TN-sähkövoimajärjestelmien yhteydessä.

Attention Ce dispositif a été conçu pour fonctionner avec des systèmes d'alimentation TN.

Warnung Das Gerät ist für die Verwendung mit TN-Stromsystemen ausgelegt.

Avvertenza Il dispositivo è stato progettato per l'uso con sistemi di alimentazione TN.

Advarsel Utstyret er utfomet til bruk med TN-strømsystemer.

Aviso O dispositivo foi criado para operar com sistemas de corrente TN.

¡Atención! El equipo está diseñado para trabajar con sistemas de alimentación tipo TN.

Warning! Enheten är konstruerad för användning tillsammans med elkraftssystem av TN-typ.

- Related Documentation**
- [General Safety Guidelines and Warnings on page 145](#)
 - [General Electrical Safety Guidelines and Warnings on page 169](#)
 - [Grounded Equipment Warning on page 162](#)
 - [Multiple Power Supplies Disconnection Warning](#)

Action to Take After an Electrical Accident

This topic applies to hardware devices in the EX Series product family, which includes switches, the EX Series Redundant Power System (RPS), and the XRE200 External Routing Engine.

This topic also applies to hardware devices in the QFX Series.

If an electrical accident results in an injury, take the following actions in this order:

1. Use caution. Be aware of potentially hazardous conditions that could cause further injury.
2. Disconnect power from the device.
3. If possible, send another person to get medical aid. Otherwise, assess the condition of the victim, then call for help.

- Related Documentation**
- [General Safety Guidelines and Warnings on page 145](#)
 - [General Electrical Safety Guidelines and Warnings on page 169](#)
 - [AC Power Electrical Safety Guidelines on page 172](#)
 - [DC Power Electrical Safety Guidelines on page 175](#)

PART 8

Compliance Information

- [Compliance Information on page 187](#)

CHAPTER 20

Compliance Information

- [Agency Approvals for EX Series Switches on page 187](#)
- [Compliance Statements for EMC Requirements for EX Series Switches on page 188](#)
- [Compliance Statements for Acoustic Noise for EX Series Switches on page 191](#)
- [Declaration of Conformity for EX3300 Switches on page 192](#)

Agency Approvals for EX Series Switches

This topic applies to hardware devices in the EX Series product family, which includes switches, the EX Series Redundant Power System (RPS), and the XRE200 External Routing Engine.

These hardware devices comply with the following standards:

- Safety
 - CAN/CSA-C22.2 No. 60950-1 (2007) Information Technology Equipment
 - UL 60950-1 (2nd Ed.) Information Technology Equipment
 - EN 60950-1 (2006) Information Technology Equipment
 - IEC 60950-1 (2005) Information Technology Equipment
 - EN 60825-1 (2007) Safety of Laser Products - Part 1: Equipment classification and requirements
- EMC
 - FCC 47CFR Part 15 Class A (USA)
 - EN 55022 Class A Emissions (Europe)
 - ICES-003 Class A
 - VCCI Class A (Japan)
 - AS/NZS CISPR 22 Class A (Australia/New Zealand)
 - CISPR 22 Class A
 - EN 55024

- EN 300386
- EN 61000-3-2 Power Line Harmonics
- EN 61000-3-3 Voltage Fluctuations and Flicker
- EN 61000-4-2 ESD
- EN 61000-4-3 Radiated Immunity
- EN 61000-4-4 EFT
- EN 61000-4-5 Surge
- EN 61000-4-6 Low Frequency Common Immunity
- EN 61000-4-11 Voltage Dips and Sags

**Related
Documentation**

- [Compliance Statements for EMC Requirements for EX Series Switches on page 188](#)
- [Compliance Statements for Acoustic Noise for EX Series Switches on page 191](#)

Compliance Statements for EMC Requirements for EX Series Switches

This topic applies to hardware devices in the EX Series product family, which includes switches, the EX Series Redundant Power System (RPS), and the XRE200 External Routing Engine.

This topic describes the EMC requirements for these hardware devices for:

- [Canada on page 188](#)
- [European Community on page 189](#)
- [Japan on page 189](#)
- [Korea on page 189](#)
- [United States on page 190](#)
- [FCC Part 15 Statement on page 190](#)
- [Nonregulatory Environmental Standards on page 190](#)

Canada

This Class A digital apparatus complies with Canadian ICES-003.

Cet appareil numérique de la classe A est conforme à la norme NMB-003 du Canada.

The Industry Canada label identifies certified equipment. This certification means that the equipment meets certain telecommunications network protective, operational, and safety requirements. Industry Canada does not guarantee the equipment will operate to the users' satisfaction.

Before installing this equipment, users should ensure that it is permissible to connect the equipment to the facilities of the local telecommunications company. The equipment must also be installed using an acceptable method of connection. In some cases, the inside wiring associated with a single line individual service may be extended by means of a certified connector assembly. The customer should be aware that compliance with the above conditions may not prevent degradation of service in some situations.

Repairs to certified equipment should be made by an authorized Canadian maintenance facility designated by the supplier. Any repairs or alterations made by the user to this equipment, or equipment malfunctions, may give the telecommunications company cause to request the user to disconnect the equipment.



CAUTION: Users should not attempt to make electrical ground connections by themselves, but should contact the appropriate inspection authority or an electrician, as appropriate.

Users should ensure for their own protection that the electrical ground connections of the power utility, telephone lines, and internal metallic water pipe system, if present, are connected together. This precaution may be particularly important in rural areas.

European Community

This is a Class A device. In a domestic environment this device may cause radio interference, in which case the user may be required to take adequate measures.

Japan

この装置は、クラス A 情報技術装置です。この装置を家庭環境で使用すると電波妨害を引き起こすことがあります。この場合には使用者が適切な対策を講ずるよう要求されることがあります。 VCCI-A

The preceding translates as follows:

This is a Class A device. In a domestic environment this device may cause radio interference, in which case the user may be required to take adequate measures.

VCCI-A

Korea

이 기기는 업무용(A급) 전자파적합기기로서 판매자 또는 사용자는 이 점을 주의하시기 바라며, 가정외의 지역에서 사용하는 것을 목적으로 합니다.

Korean Class A Warning

90-0013

The preceding translates as follows:

This equipment is Industrial (Class A) electromagnetic wave suitability equipment and seller or user should take notice of it, and this equipment is to be used in the places except for home

United States

The device has been tested and found to comply with the limits for a Class A digital device, pursuant to Part 15 of the FCC Rules. These limits are designed to provide reasonable protection against harmful interference when the equipment is operated in a commercial environment. This equipment generates, uses, and can radiate radio frequency energy and, if not installed and used in accordance with the instruction manual, may cause harmful interference to radio communications. Operation of this equipment in a residential area is likely to cause harmful interference, in which case the user will be required to correct the interference at his own expense.

FCC Part 15 Statement

This equipment has been tested and found to comply with the limits for a Class A digital device pursuant to Part 15 of the FCC Rules. These limits are designed to provide reasonable protection against harmful interference in a residential installation. This equipment generates, uses, and can radiate radio frequency energy and, if not installed and used in accordance with the instructions, may cause harmful interference to radio communications. However, there is no guarantee that interference will not occur in a particular installation.

If this equipment does cause harmful interference to radio or television reception, which can be determined by turning the equipment off and on, the user is encouraged to try and correct the interference by one or more of the following measures:

- Reorient or relocate the receiving antenna.
- Increase the separation between the equipment and the receiver.
- Connect the equipment into an outlet on a circuit different from that to which the receiver is connected.
- Consult the dealer or an experienced radio or TV technician for help.

Nonregulatory Environmental Standards

NEBS compliance—These EX Series switch models are Network Equipment Building System (NEBS) compliant:

- EX2200-24T and EX2200-48T
- EX3200-24T, EX3200-48T
- EX3300-24T, EX3300-48T
- EX4200-24F, EX4200-24T, and EX4200-48T
- All EX4500 switch models with AC power supplies

- All EX6200 models



NOTE: For the EX6200-48P line cards, the intra-building ports must use shielded intra-building cabling or wiring that is grounded at both ends.

- All EX8200 models

Those switch models meet the following NEBS compliance standards:

- SR-3580 NEBS Criteria Levels (Level 3 Compliance)
- GR-1089-CORE: EMC and Electrical Safety for Network Telecommunications Equipment
- GR-63-CORE: NEBS, Physical Protection
 - The equipment is suitable for installation as part of the Common Bonding Network (CBN).
 - The equipment is suitable for installation in locations where the National Electrical Code (NEC) applies.
 - The battery return connection is to be treated as an Isolated DC return (DC-I), as defined in GR-1089-CORE.

**Related
Documentation**

- [Agency Approvals for EX Series Switches on page 187](#)
- [Compliance Statements for Acoustic Noise for EX Series Switches on page 191](#)

Compliance Statements for Acoustic Noise for EX Series Switches

This topic applies to hardware devices in the EX Series product family, which includes switches, the EX Series Redundant Power System (RPS), and the XRE200 External Routing Engine.

Maschinenlärminformations-Verordnung - 3. GPSGV, der höchste Schalldruckpegel beträgt 70 dB(A) oder weniger gemäss EN ISO 7779

Translation:

The emitted sound pressure is below 70 dB(A) per EN ISO 7779.

**Related
Documentation**

- [Agency Approvals for EX Series Switches on page 187](#)
- [Compliance Statements for EMC Requirements for EX Series Switches on page 188](#)

Declaration of Conformity for EX3300 Switches

JUNIPER
NETWORKS

Declaration of Conformity

CE

Juniper Networks, Inc.
1194 N. Mathilda Ave
Sunnyvale, CA 94089 USA

declares under our sole responsibility that the product:

Ethernet Switch
EX3300

is compliant with Directive 2002/95/EC (RoHS) Restriction on Hazardous Substances,
and is in conformity with the provisions of the following EC Directives, including all amendments,
and with national legislation implementing these directives:

Low Voltage Directive 2006/95/EC
EMC Directive 2004/108/EC

The following harmonized standards were applied:

EMC	EN 300 386 v1.4.1: 2008 EN 55022: 2006 + A1: 2007, Class A EN 55024: 1998 + A1:2001 + A2: 2003
Safety	EN 60950-1: 2006 + A1: 2010

This product carries the CE Mark, which was first affixed in 2011.

Place	Signature	Date
Sunnyvale, CA		7/19/2011

Michael J. Azar
Homologation Manager
1194 N. Mathilda Ave
Sunnyvale, CA 94089 USA

Doc: 11-0091

s021041

**Related
Documentation**

- [Agency Approvals for EX Series Switches on page 187](#)
- [Compliance Statements for EMC Requirements for EX Series Switches on page 188](#)
- [Compliance Statements for Acoustic Noise for EX Series Switches on page 191](#)