



True Diversity MIC System

User Manual

T-521UH/521UV

T-521UT/521US

T-521UL/521UW

Before using the system, please read this manual first

Thank you for choosing our UHF wireless microphone.

Please read the manual carefully before operation, to study the correct operation method to gain the best application effect.

This device adopts UHF double diversity reception and DPLL multi-channel frequency synthesis technology. It provides 200 channel selections for each frequency bandwidth 800MHz, 700MHz and 600MHz by 250KHz channel spacing, in order to avoid interference easily.

Handheld wireless microphone UHT and hanging transmitter are both equipped with high and low power conversion function. The power is supplied by two AA batteries. The service time shall be longer if using alkaline high energy battery, for example, 10 hours for high power and 15 hours for low power. On the contrary, the service time shall be shorten if using rechargeable battery.

Adjust the sensitivity of transmitter correctly is the most important, because signal distortion may be happened if sensitivity is too high and signal noise ratio may be reduced if sensitivity is too low. Users don't need to adjust the sensitivity of the handheld microphone, because it's already adjusted to a suitable level. However, the sensitivity of ULT hanging transmitter can be adjusted through the lapel microphone, headband microphone and outer audio source.

During the high power status in the same space, 16 transmitters used with the same frequency channel will not cause mutual interference. But mutual interference will happen if the frequency is set inappropriately. During the low power status, for example, in KTV room and classroom, about 200 transmitters can be used at the same time and will not cause the mutual interference.

1、Transmitter Framework and Function

Front Panel

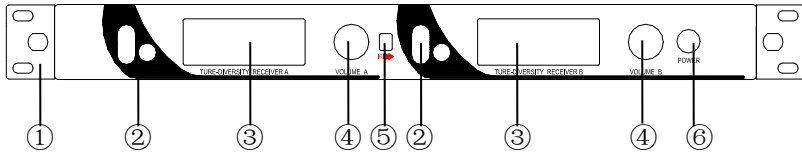

Back Panel

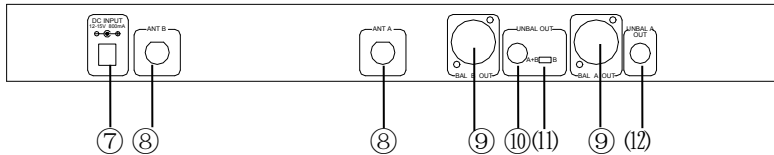

- (1) Mounting Ear. If to put in 19 inch rack, please screw off the two nails on the sides of the device, then fix the ear on nail hole sites. Nylon can separate the noise interference from the amplifier and other devices.
- (2) Function Key. Press “SET” key to cycle pick the main menu, stop 2~3 seconds to choose one menu and current set state will be showed on the screen. Press “▲▼” key to change or reset the menu, then press “SET” key to take effect.
- (3) LCD screen. Display the operation mode, frequency/channel, audio output intensity. LCD screen will be on when power is switch is on.
- (4) Volume adjusting knob. To adjust the output volume of transmitter.
- (5) Frequency pairing window.
- (6) Power switch. When the switch is on, the LCD screen is on. Long press the switch to turn off the power.
- (7) Power socket. 12V DC/1A power input socket, positive inside

and negative outside.

- (8) Antenna pedestal. BNC pedestal.
- (9) Audio balance output. Adopt "XLR" plug seat, two channel signal output separately.
- (10) Toggle switch to A+B. Two channels will be combined to one channel as unbalanced output.
- (11) Toggle switch to B. B channel unbalanced output.
- (12) Toggle switch to A. A channel unbalanced output.

2、 How to operate the receiver

(1) before the start, not open the transmitter, turn the receiver volume to minimum, and then press the power button to open the receiver. When the power is turned on, the LCD screen background lights, all the characters are displayed in the same shutdown state of the last time. then the main display column shows the receiver channel, frequency, automatic frequency state, squelch level, the "SET" button can make the main display in various content menu.

(2) Before the system be turned on, you should observe the auxiliary display bar of the RF and AF level meter, if there is a strong interference, should change the channel to avoid interferences or small receiver sensitivity in the menu.

(3) Open the transmitter power, such as transmitter and receiver to different frequency, the frequency. RF level intensity control after the completion of the corresponding channel frequency receiver display full lattice, the receiver to adjust the volume to the appropriate size, and then the microphone pronunciation, receiver AF level strength with pickup size variation. If there is no sound output and RF level display, this system does not work properly, we must overhaul.

(4) 3 open the transmitter power, such as transmitter and receiver to different frequency, the frequency

3、 Operating instruction of the liquid crystal display panel

(1) LCD full bright display

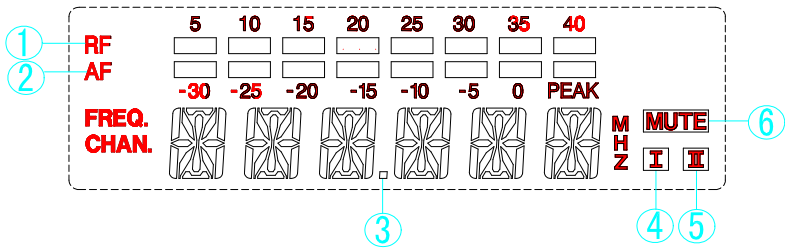

- ① 8 RF display: display the received radio frequency signal strength
- ② 8 audio level display: display the level of the audio signal
- ③ Frequency menu display: when FREQ is light, the six characters displays the current operating frequency
- ④ Channel menu display: when CHAN is light, it displays the current working channel
- ⑤ Six characters display: display working state of frequency, frequency/channel, noise level or menu content
- ⑥ MUTE display: When mute is light, then no RF signal is received
- ⑦ Channel selection display: Dynamic display of the current received channel

(2) Key functions and operation

Press "SET" key to choose menu and confirm the configuration.

Press "▲" "▼" adjust the currently selected menu, then press "SET" to confirm to setting.

Long press "▲" and "▼" keys can quickly set frequency, channels.

(3) Instructions for the LCD panel

A Frequency setting: press "SET" button, select PRG IR for 2 seconds, infrared data would be sent to the transmitter.

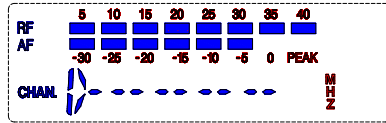
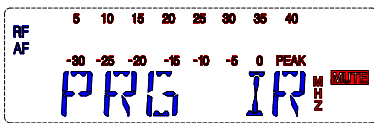

B Menu in main display column

Press "SET" display the below:

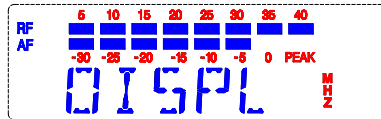

After 2-3 seconds it will display the below:

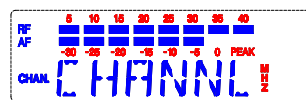
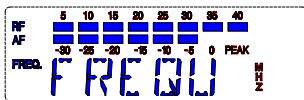

(Note: Which of the above will be showed depends on the previous set)

This menu is for selecting the main display column, when press "▲" or "▼" key, the LCD shows "CHANNL" or "FREQU". Select "CHANNL" it displays the channel number, select "FREQU" it displays the current working frequency.

Please click the "SET" key to confirm after your selection, otherwise it is invalid, the main column will keep the previous display. When you changed the choice but not confirm the LCD screen after 2-3 seconds, it will remind by flashing, press the "SET" key then the LCD stop flashing.

C Display and adjustment of Channel/frequency

Press "SET" to make the LCD display the below:

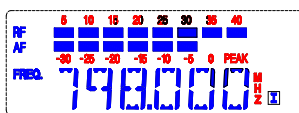
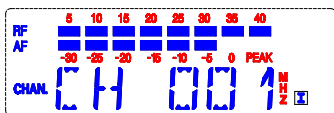

(Note: Which of the above will be showed depends on the previous set)

This menu displays the current working frequency or channel of the receiver, press "▲" key "▼" button to change the current channel or frequency, after change the frequency or channel, please press the "SET" key to confirm and make the receiver works in the selected frequency or channel. Otherwise the adjustment will be invalid, the receiver will still work in the previous channel/frequency.

When you changed the choice but not confirm the LCD screen after 2-3 seconds, it will remind by flashing, press the "SET" key then the LCD stop flashing.

D Receiver noise control

Press "SET" to display the below:

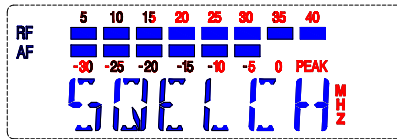

After 2-3 seconds it will display:

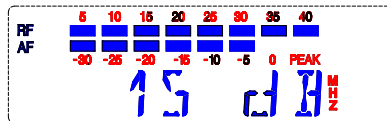

This menu is used to adjust the receiver noise, in order to enhance anti-jamming capability of the system. Adjust the range is from 0 to 40 db, the greater the value, the lower the sensitivity, the closer distance, the stronger anti-interference ability. Whereas the smaller the value (minimum in 10 db), the higher the sensitivity of the farther the distance, but the anti-interference ability will decline. When normal use, please set in 15 db (the default factory setting is 15 db)

Push "▲" or "▼" button to adjust the data, press the "SET" to confirm the adjustment, otherwise the sensitivity will stay as previous.

Without press "SET" after data adjustment for 2-3 seconds, the LCD will remind by flashing, press the "SET" key then the LCD stop flashing.

E The system lock operation

Press "SET" to display the below:

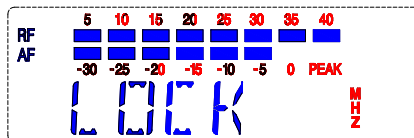

After 2-3 seconds it will display:

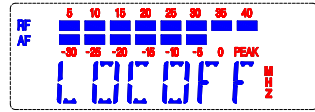
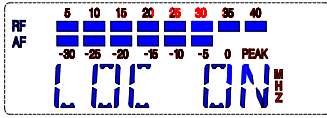

(Note: Which of the above will be showed depends on the previous set)

This menu function is, whether lock the current receiver working status (channel, sensitivity, in the main display column, the power switch, etc.), if shows "LOC ON", it can't change the current working status and the machine can not be turned off; If shows "LOC OFF", the can change all the menu functions.

Please click the "SET" key to confirm after your selection, otherwise it is invalid, the main column will keep the previous display. When you changed the choice but not confirm the LCD screen after 2-3 seconds, it will remind by flashing, press the "SET" key then the LCD stop flashing.

4 、 Infrared frequency wireless microphone hand-held transmitter

4.1 Framework and Function

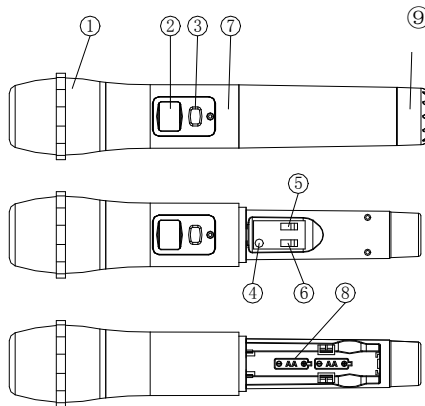

- (1) net head and a sound head module: net head is used to protect the voice into the sound head module of audio signals, eliminating tuency / channel and battery.
- (3) the power switch: touch click for the "POP" wind noise, and can prevent the microphone placed rolling on the table.
- (2) liquid crystal display: display freq
he boot state; 3 seconds long for shutdown state.
- (4) infrared frequency window with the SET key: the receiver, the channel parameters are transmitted to the transmitter
- (5) high and low power switch: used to convert the microphone high / low emission power.
- (6) Locking switch: used to lock the keys, in the "ON" button, an external power supply cannot be shut down only mute, meet the requirements of special occasions, to avoid in the course of the performance error action.
- (7) Microphone pipe: pipe end assembly head, the sound head module, the tube body battery, emitting circuit board, tail built-in antenna.
- (8) Battery window: with 2 AA batteries
- (9) PC tail pipe

4.2 Operation Manual

MIC LED

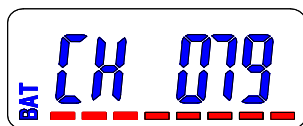

After turning the power on, the LED backlight bright, liquid

crystal display the current working channel and battery. If you need to change the channel, the receiver channel should be changed first. And then match the transmitter and receiver for infrared alignment frequency window, and press the "SET receiver". Then the new frequency channel parameters will be sent to the transmitter.

5 、 Infrared frequency wireless microphone lavalier transmitter

Name and function of each parts

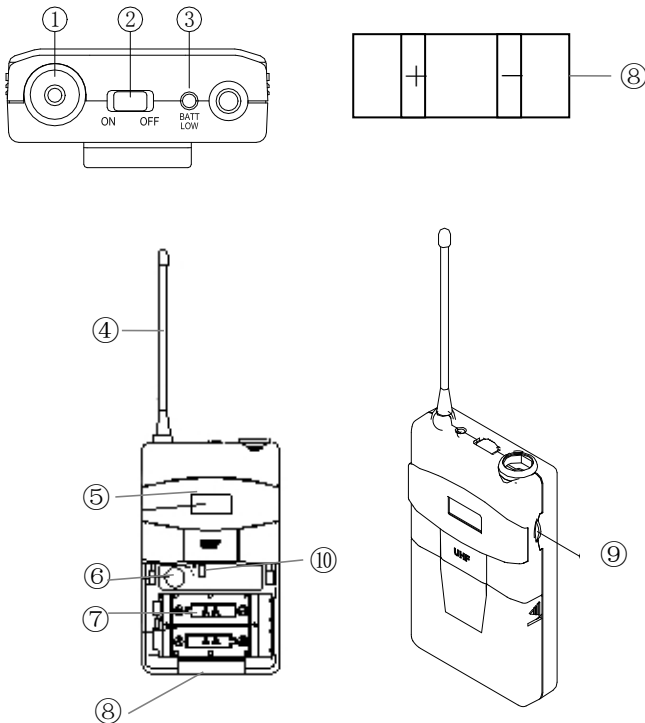

- (1) Audio input connector
- (2) Power switching: turn the switch to “ON” position when using; turn it to “OFF” position when not using
- (3) Status indicator: when the switch is turned to “ON” position, the indicator will flash, which means the battery level is normal; if it does not flash, it means the battery is no power or not well installed; if the indicator stays on, it means the battery is dying and needs to be changed
- (4) Transmitting antenna: the transmitting antenna is a 1/4 wave whip
- (5) LCD panel: it displays the current working frequency/channel and the battery level
- (6) Infrared frequency window: it works with the SET key of the receiver to deliver the channel dates to the transmitter
- (7) Battery compartment: it contains 2 pcs AA batteries
- (8) Battery cover: it covers the batteries after installing the 2 pcs AA batteries
- (9) The adjust or of the transmitting audio sensitivity
- (10) High & Low Function conversion keys: It is designed for converting the high and low transmitted power

6、 Operation

Pressing lightly on both ends of the battery cover to pull out the battery compartment. The operation is as same as the handheld mic, which also has the functions of high & low power switching and adjusting of transmitting audio sensitivity to adapt to different sound other audio sources.

6.1 How to use the hanging wireless transmitter

(1) The hanging mic transmitter adopts a 1/4 wave whip, which could not directly contact with human body or twine with the mic

wires, otherwise it will reduce the use effect.

(2) The sensitivity should be adjusted according to different audio sources and mics.

(3) While using the clip mics, in order to keep the voice not up and down by the rotation of the head, you should put the clip mic in the middle position and fix the mic wire to avoid any friction noise.

(4) The sound head of the headset mic should be put beside the mouth. The voice could be increased by adjusting the distance between the mouth and the sound head.

(5) When using the clip mic in the sound system, it is better to choose the directional sound head and the speakers with less acoustic feedback. For the sake of reducing acoustic feedback, feedback suppressor should be used as well.

6.2 How to use the handheld wireless mic

(1) Your hand should be held in the centre of the mic. Do not put your hand closed to the mic head or the sound pickup effect will be influenced. If closed to the bottom antenna, the emission efficiency and the using range will be reduced.

(2) Adjust the distance between the mic and your mouth to increase or decrease the voice.

6.3 How To Use Receiver Correctly

(1) Receiver is divided into two categories, diversity and non diversity. Non diversity is economy, while diversity has longer transmission distance and better transmission effect. Users can choose reasonably according to their demands.

(2) When using omnidirectional antenna, antenna shall have 0.5 meter's distance from the wall, especially metal form.

(3) Receiving range is related to many factors. It can gain a better transmission effect when there is no large metal obstacle on the

transmission direction.

(4) If receiving condition is not good, extension cord and high gain antenna can be adopted, or even to add antenna amplifier to get a very obvious long distance transmission effect.

(5) When receiver panel face to the application direction, or that when receiver is put in metal box, connect the antenna to front panel shall gain a better receiving effect.

6.4 Using Many Sets of Microphone at The Same Place

(1) Choose the frequency allocation without intermodulation. Within the 25MHz band with, it usually can using 8 transmitters at the same time. Other frequency channel type shall be used if users need more than 8 sets transmitters.

(2) When using many transmitters at the same time, there shall be more than 20cm's distance between each transmitter to avoid mutual interference.

(3) When using many receivers at the same time, high gain antenna, antenna amplifier and receiving shut is suggest to installed.

(4) If the transmitter is set as low power, 100 transmitters can be used within the same frequency channel, such as in KTV room, classroom.

7、 Fault processing and preservation

Fault Phenomenon	Fault Reasons
No indication from the Transmitter and Receiver	The battery of transmitter runs out or the power connection of the receiver is loose.
No radio wave from the receiver	The received frequencies are different or out of the receiving range
There is radio wave but without any audio signal	The mic of transmitter is not connected or the squelch of the receiver is too high
The background noise of audio signal is too big	The transmitting modulation is too weak and the received output level is too low to cause the interrupt signal.
Audio signal distortion	The transmitting modulation is too strong and the received output level is too high
The using distance is too short and the signal is not stable	The power of transmitter is set at low level and the receiver squelch is too high. The antenna of the receiver is not set properly and there is strong electromagnetic interference

Do not unpack or repair the machine by yourself if the failures are not contained in the above table. Pls contact with the manufacturer or your local dealer.

Operation and Preservation: Don't put the unit in high humidity or strong magnetic field, or under strong direct sunlight, or high temperature environments . The receiver power and transmitter batteries should be brought out if there is no operation for a long time.

Clearance: Pls unplug the power socket before clearance and use the stupe to clean it. Never use any cleaner or soluble liquid, or it will damage the surface machining layer.

Power Supply : Ensure the power supply is within the range of requirement. Too high or too low power will affect the machine's performance. When put the transmitter into battery, do not install the battery backwards , otherwise the machine may be damaged .

Maintenance : If the machine has a fault or performance degradation, in order to avoid electric shock or severe damage or warranty right loss, please do not remove the shell for repair by yourself . Pls contact with the local dealer or the manufacturer, and we shall provide our best service for you.

Accessory: Pls use the accessories provided and apporved by the manufacturer to make sure the best performance.

Warranty: There is no modification section in the unit. Pls do not take it apart, or you will lose the warranty right.

8、 Specifications

Frequency range: 640-690MHz and 740-790MHz, ,807-857MHz

Frequency oscillation mode: phase-locked loop

Total channels: 600 CH

Frequency response: 50Hz---18KHz

Working distance: 300

Frequency bandwidth: 25MHz

Carrier Wave stability: $\pm 5\text{PPm} \leq 10\text{KHz}$

Crosstalk: $> 80\text{dB}$

S/N Ratio: $> 105\text{dB}(1\text{KHz-A})$

Sensitivity: $-105\text{dBm}(12\text{dB S/N AD})$

THD: $< 0.5\% @ 1\text{kHz}$

Output Impedance: $2.2\text{k}\Omega$

Audio output bit: -12dB

Mute mode: Mute and Tone key squelch loop

Function display: LCD

Power supply: 12V 1A

Output Connector Mode: Balanced XLR Connector

Unbalanced TRS: 6.3mm connector

True Diversity MIC System

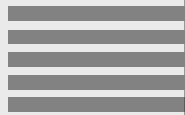

itC

