

IP Villa System Quick Start Guide

Welcome

Thank you for purchasing our device!

This quick start guide will help you become familiar with our device in a very short time.

Before installation and operation, please read the following safeguard and warning carefully!

Important Safeguard and Warning

1 . Electrical safety

All installation and operation here should conform to your local electrical safety codes.

The product must be grounded to reduce the risk of electric shock.

We assume no liability or responsibility for all the fires or electrical shock caused by improper handling or installation.

2 . Transportation security

Heavy stress, violent vibration or water splash are not allowed during transportation, storage and installation.

3 . Installation

Keep upwards. Handle with care.

Do not apply power to the device before completing installation.

Do not place objects on the device.

4 . Qualified engineers needed

All the examination and repair work should be done by the qualified service engineers.

We are not liable for any problems caused by unauthorized modifications or attempted repair.

5 . Environment

The device should be installed in a cool, dry place away from direct sunlight, inflammable, explosive substances and etc.

6. Accessories

Be sure to use all the accessories recommended by manufacturer.

Before installation, please open the package and check all the components are included:

Contact your local retailer ASAP if something is missing in your package.



CAUTION

FOR YOUR OWN SAFETY, PLEASE CHANGE SYSTEM DEFAULT PASSWORD AFTER YOU FIRST LOGIN!

Table of Contents

1	Typical Connection	3
2	General Settings.....	4
2.1	Change Default Password.....	4
2.2	VTO Settings	4
2.3	Master Digital VTH Settings.....	6
2.4	Digital Extension VTH Settings.....	8
2.5	Change Villa VTO IP via VTH.....	9
2.6	Check Results	12
3	Network Camera Settings.....	13
3.1	VTH Settings	13
3.2	Add Dahua Network Camera	13
3.3	Add ONVIF Network Camera	13
3.4	Check Results	14
3.5	VTO Settings	14
3.5.1	Add Dahua Network Camera	14
3.5.2	Check Results.....	14
4	Cell Phone Settings	15
4.1	VTO Settings	15
4.2	Cell Phone Settings.....	15
4.3	Check Results	17
5	Installation	18
5.1	VTO Installation.....	18
5.1.1	Direct Installation.....	18
5.1.2	Embedded in Wall	19
5.2	VTH Installation.....	21
5.2.1	Installation Mode 1	21
5.2.2	Installation Mode 2	21
6	Electric Lock and Magnetic Door Lock	22
6.1	Electric Door Lock.....	22
6.2	Magnetic Door Lock	22
7	Appendix Specifications	23

1 Typical Connection

Note: All the installation and operations here should conform to your local electric safety rules.

When a visitor press call button on VTO, multiple VTHs will ring at the same time. You can call, hang up, and unlock on any of these VTHs.

1.1 IP Connection Mode 1

This mode is for VTO2000A/VTH1550CH/VTH1560B.

VTH has one master VTH and up to three extension VTHs. See Figure 1-1.

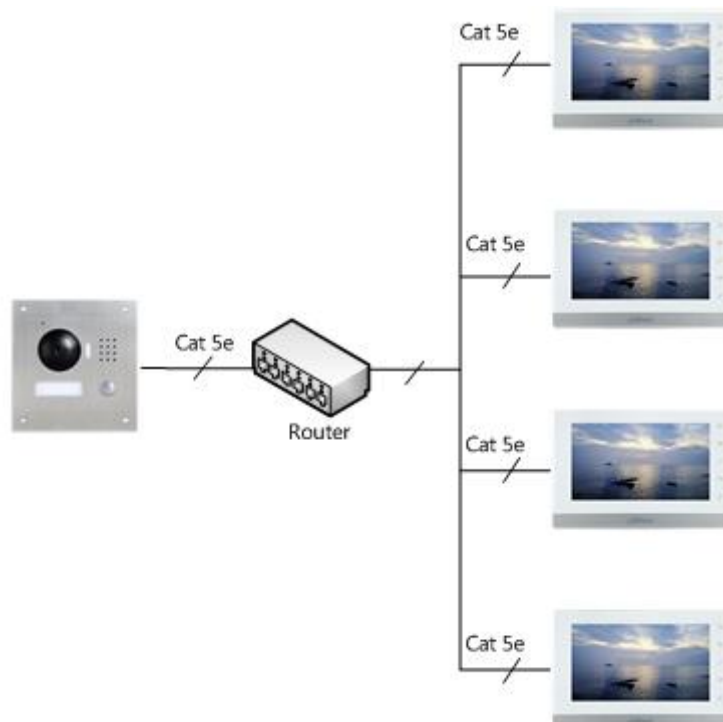

Figure 1-1

1.2 IP Connection Mode 2

This mode is for VTO2000A-2/VTH1550CHW-2.

The VTH has two types: one master VTH and up to three extension VTHs. See Figure 1-2.

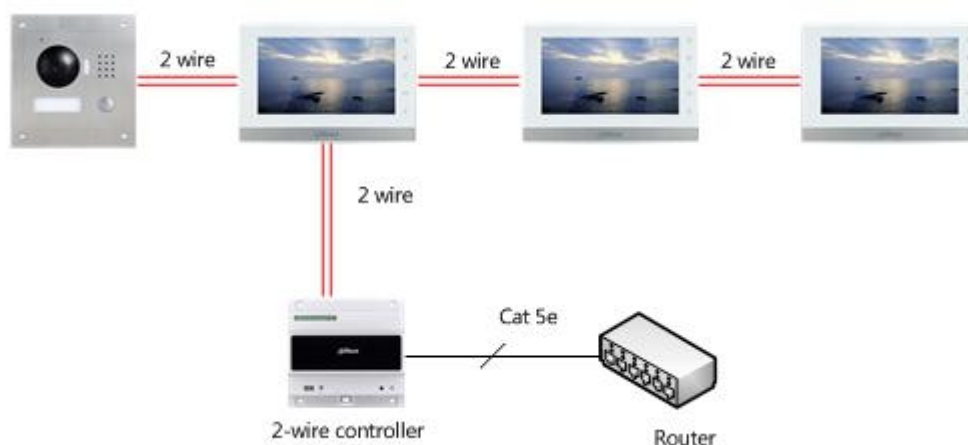

Figure 1-2

2 General Settings

The VTO default IP address is 192.168.1.110. The default WEB account is: user name: **admin**, password: **admin**.

The VTH default IP address is 192.168.1.109, the project password is **002236**.

After the connection, please make sure the VTH and VTO connection are OK. **Please change the default password after your first login.**

2.1 Change Default Password

Please refer to Figure 2-1 to change VTO password.

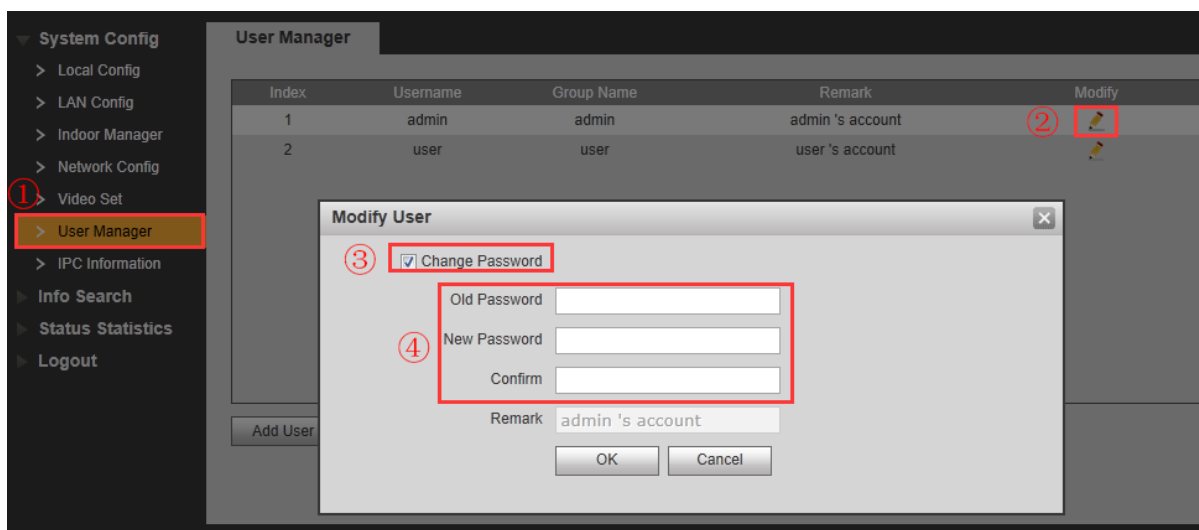

Figure 2-1

Please refer to Figure 2-2 to change account password, open door password, arm/disarm password, an-hijack password of the VTO (Settings->Password).



Figure 2-2

2.2 VTO Settings

- Please use the PC to access the VTO. Open the browser and then input the VTO IP address. Click the Enter, input user name and password to login. System supports English, Russian, Italian, French, Germany, Dutch, Spanish, and Portuguese by default. See Figure 2-3.

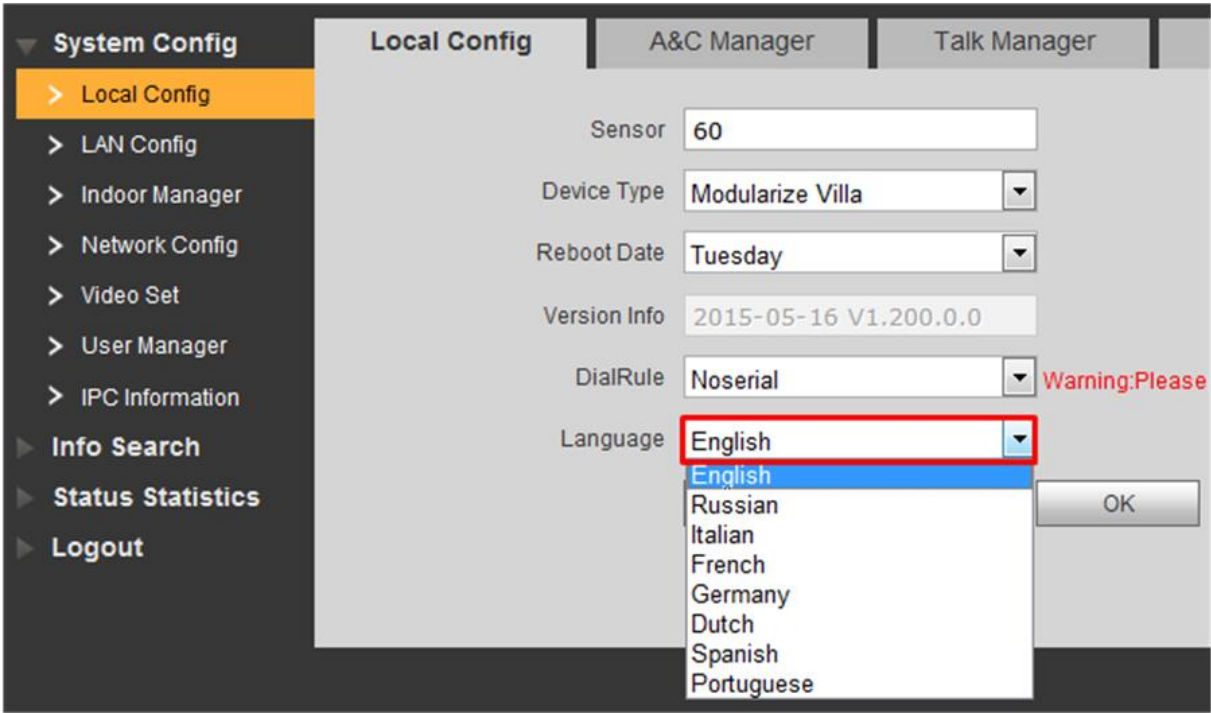

Figure 2-3

b) Now you can set local information. See Figure 2-4.

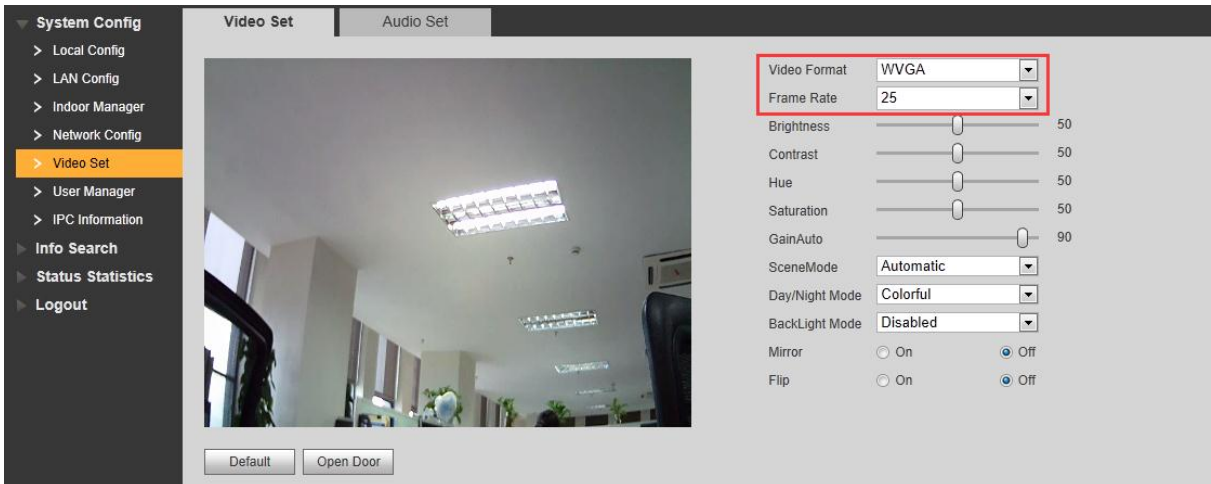

Figure 2-4

c) Now you can add digital VTH. System has added room 9901 by default. See Figure 2-5.

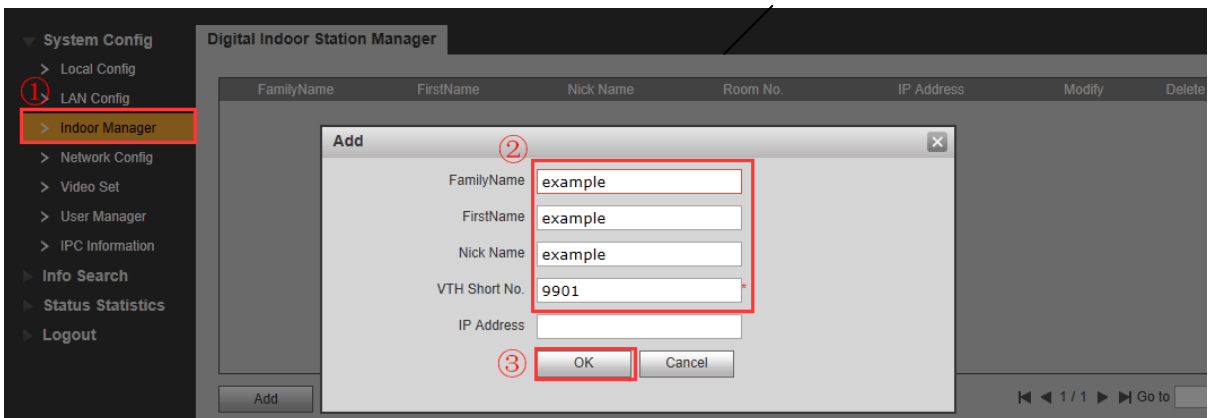

Figure 2-5

d) Set network information. See Figure 2-6.

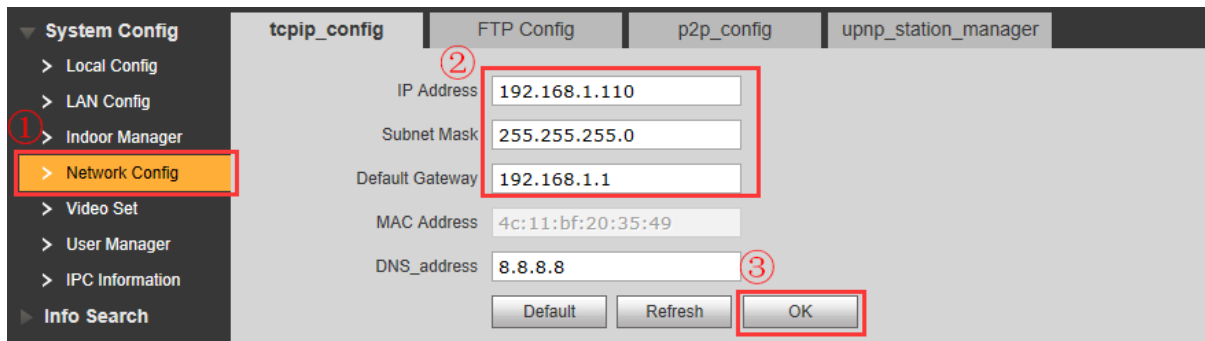

Figure 2-6

2.3 Master Digital VTH Settings

a) When device is booting up, you can set device language. System supports English, Russian, Italian, French, Germany, Dutch, Spanish, and Portuguese by default. See Figure 2-7. After device booted up, you can go to Settings->Language->002236 to change language again.

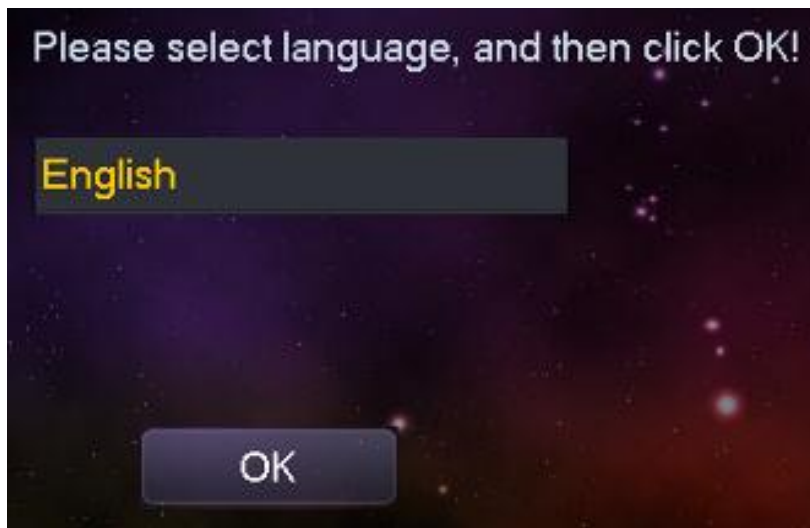

Figure 2-7

b) On the main VTH menu, from System->Project, you can input project password **002236** to go to the project setup interface.

c) Set current VTH as the master VTH. See Figure 2-8.

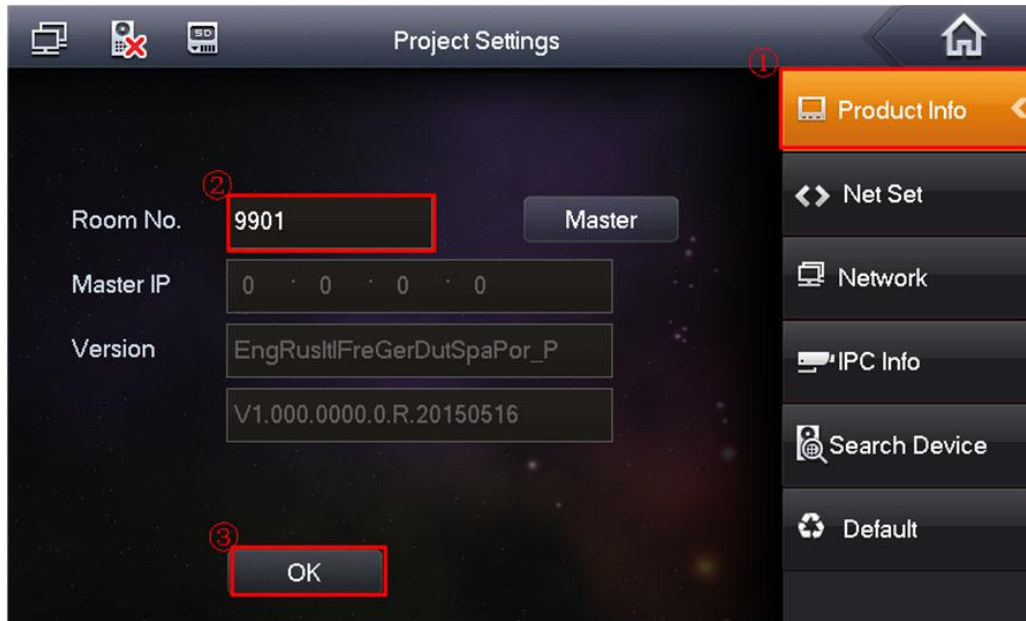

Figure 2-8

d) Click Network on the right pane, and then input master VTO name, IP address and enable current function.

Note: Click  to go to the extension VTO interface; you can set extension VTO information. You can several extension VTOs at the same time. See Figure 2-9.



Figure 2-9

2.4 Digital Extension VTH Settings

a) On the extension VTH menu, from System->Project, you can input project password (002236) to go to the project interface.

b) Set current VTH as extension VTH.

Step1 Press Product Info, See Figure 2-10

Step2 Press Master, Master icon becomes Extension icon.

Step3 Set Room No. (i.e. 9901-1), input IP Address, Subnet Mask and Gateway.

Step4 In Master IP, input IP of the master VTH.

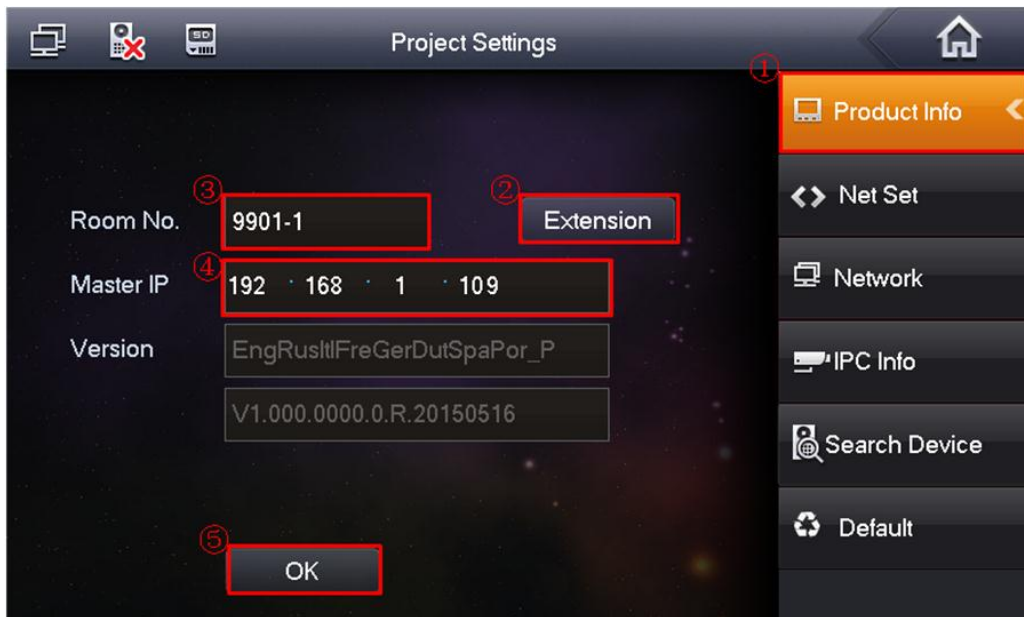



Figure 2-10

c) Click Network on the right pane and then enable current function. See Figure 2-11.



Figure 2-11

d) Click  to go to the next page to set extension VTO. Enable current function and then click OK.

Note

Please make sure the status is ON. The extension VTH can synchronize information with the master VTH. If one master VTH has several extension VTOs, please enable status as on. See Figure 2-12.

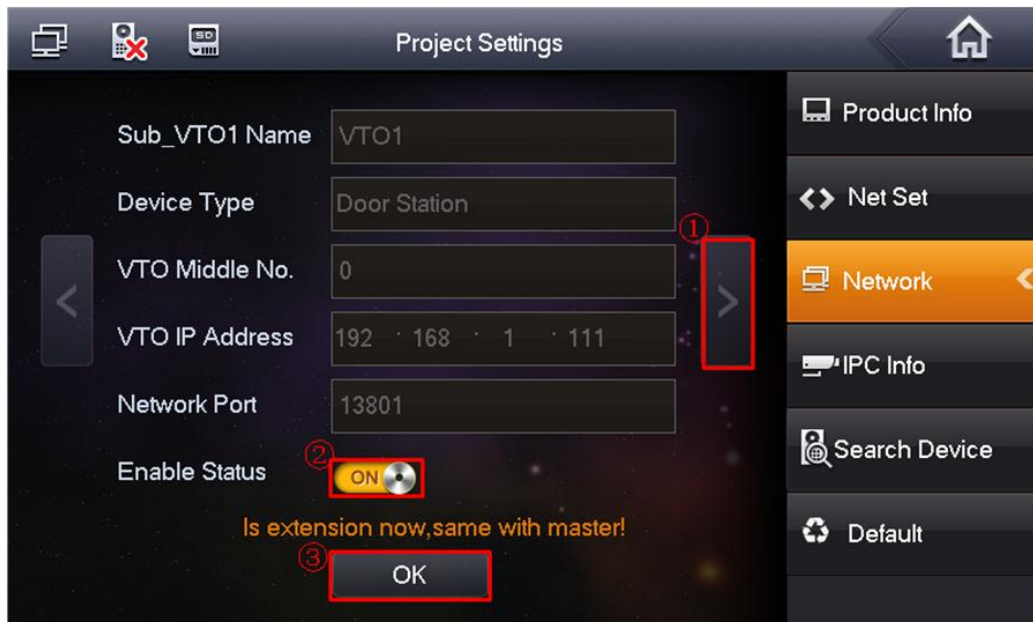

Figure 2-12

2.5 Change Villa VTO IP via VTH

- On the digital VTH interface, from Settings->Project->002236, select Search device. See Figure 2-13.

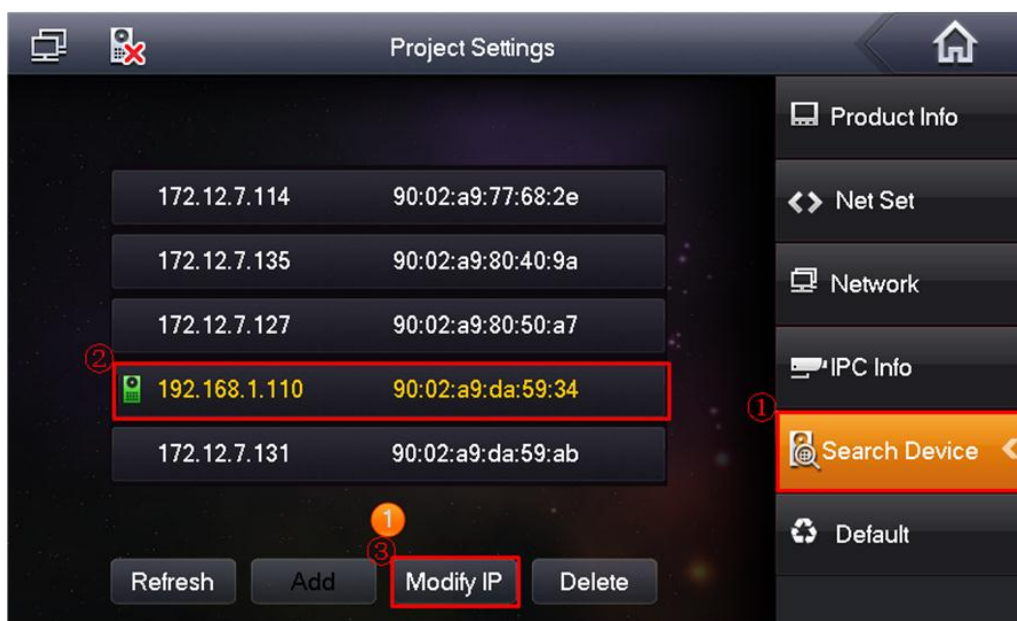

Figure 2-13

b) Change VTO IP address as 192.168.1.11. See Figure 2-14.

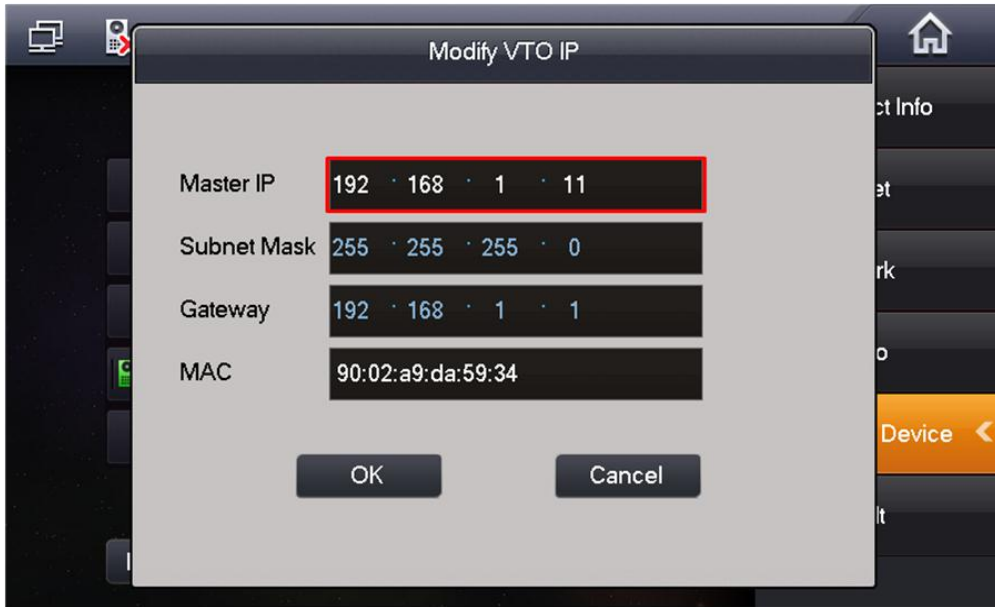

Figure 2-14

c) Click Add to add VTO settings. See Figure 2-15.

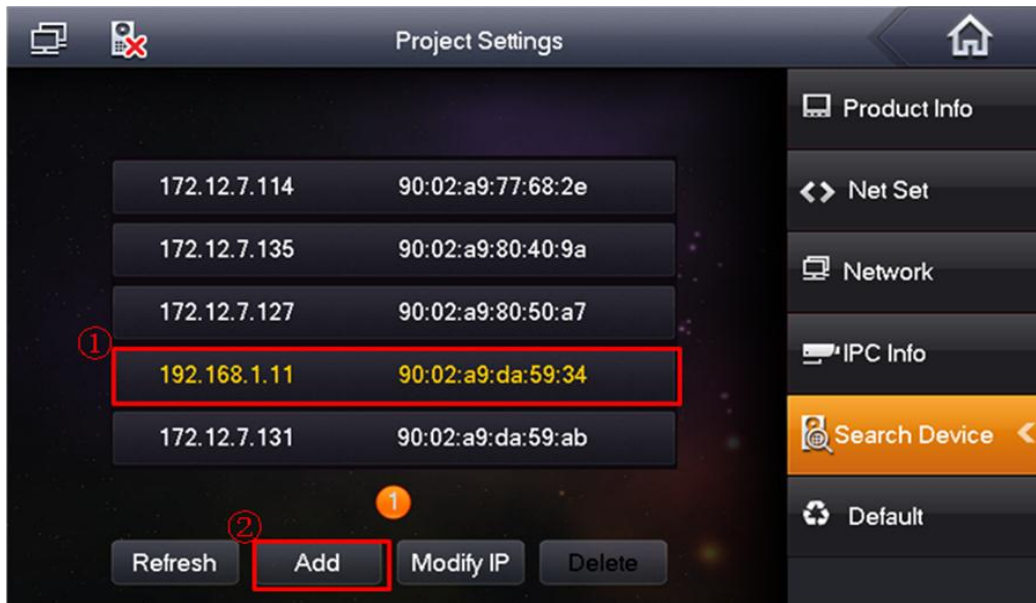

Figure 2-15

- d) Use 192.168.1.11 of the VTO to change default setup 192.168.1.110, change status as on. See Figure 2-16.



Figure 2-16

- e) Now you can see the following interface. See Figure 2-17.

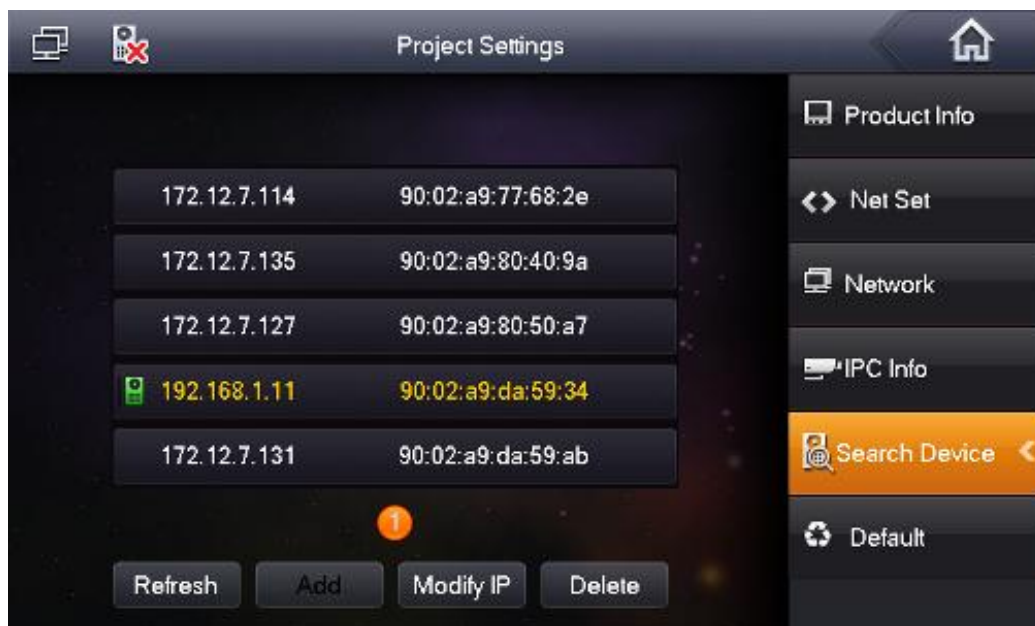

Figure 2-17

f) Or you can go to the Network interface to view the add result. See Figure 2-18.



Figure 2-18

2.6 Check Results

- On the indoor VTO, click monitor button, you can view the situation of the VTO.
- On the villa VTO, click the Call button, you can call any of the VTHs.
- For the VTH, from “Video Talk->Call User”, input “-1” to call the VTH extension number. See Figure 2-19.

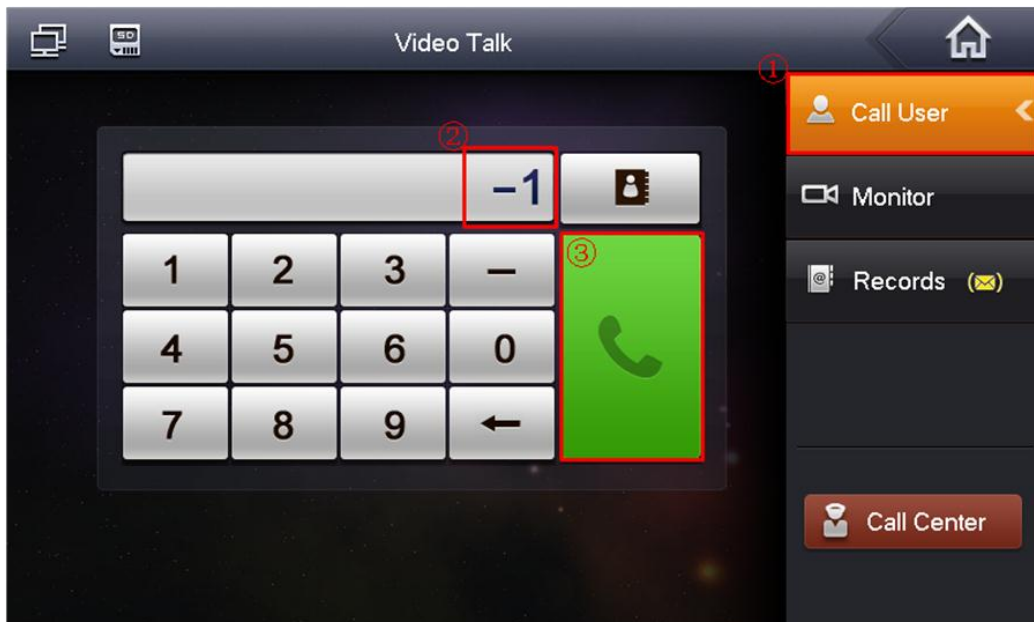

Figure 2-19

3 Network Camera Settings

3.1 VTH Settings

The VTH supports 8 network cameras. It supports product from Dahua and ONVIF protocol.

3.2 Add Dahua Network Camera

On the VTH menu, from Settings-> Local IPC, input network camera name, IP address, port (5000), protocol (local) and then click Save button. User name and password are the account for you to login the network camera. See Figure 3-1.

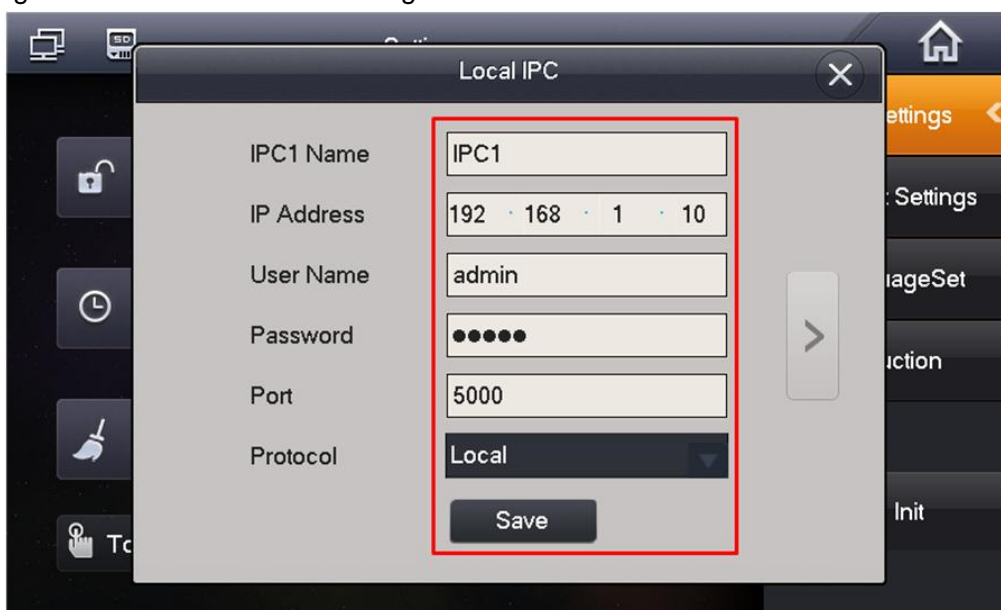

Figure 3-1

3.3 Add ONVIF Network Camera

On the VTH menu, from Settings-> Local IPC, input network camera name, IP address, port (80), protocol (ONVIF) and then click Save button. User name and password are the account for you to login the network camera. See Figure 3-2.

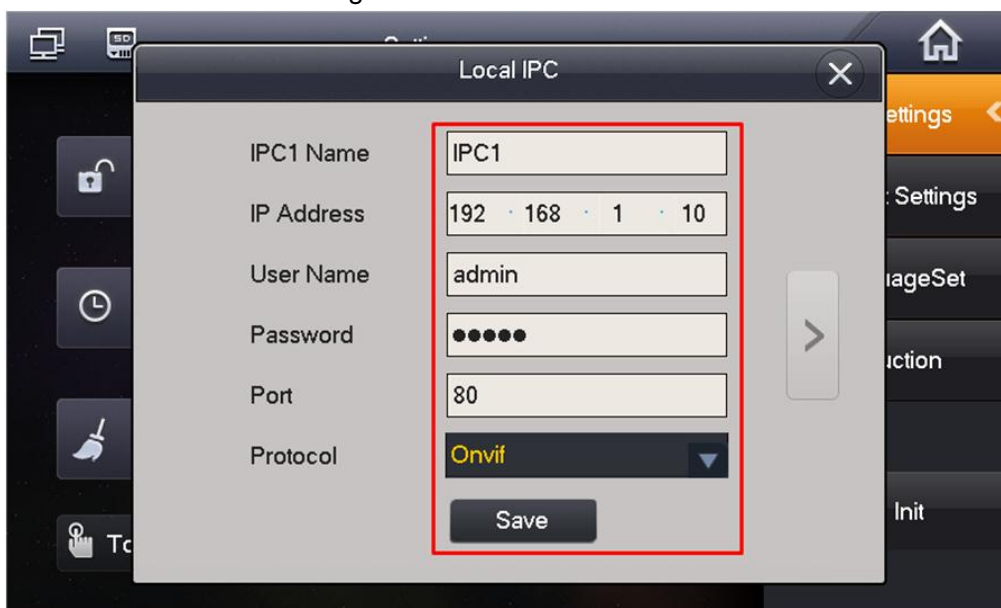

Figure 3-2

3.4 Check Results

On the VTH menu, from Video Talk-> Monitor->IPC, you can use Last Channel/Next Channel to switch to different network camera video. See Figure 3-3.

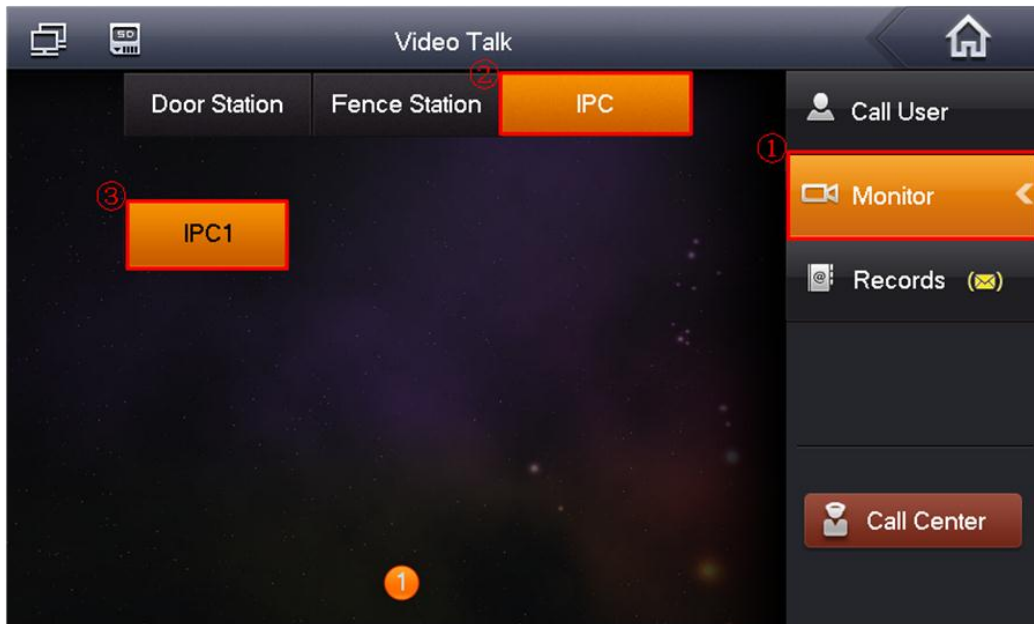

Figure 3-3

3.5 VTO Settings

For the VTO, it supports 24 network cameras. It supports product from Dahua.

3.5.1 Add Dahua Network Camera

Please refer to the following interface. See Figure 3-4.

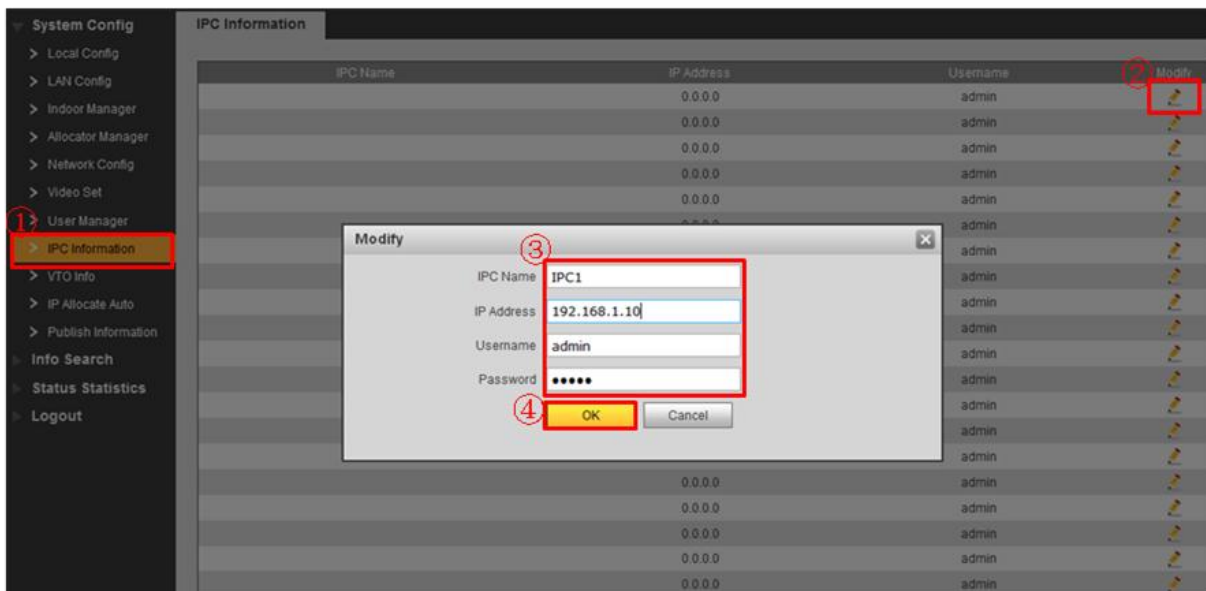

Figure 3-4

3.5.2 Check Results

Please refer to chapter 3.4.

4 Cell Phone Settings

4.1 VTO Settings

- a) Go to the Network interface, set VTO IP address so that it can connect to the network. Set local DNS address. See Figure 4-1.

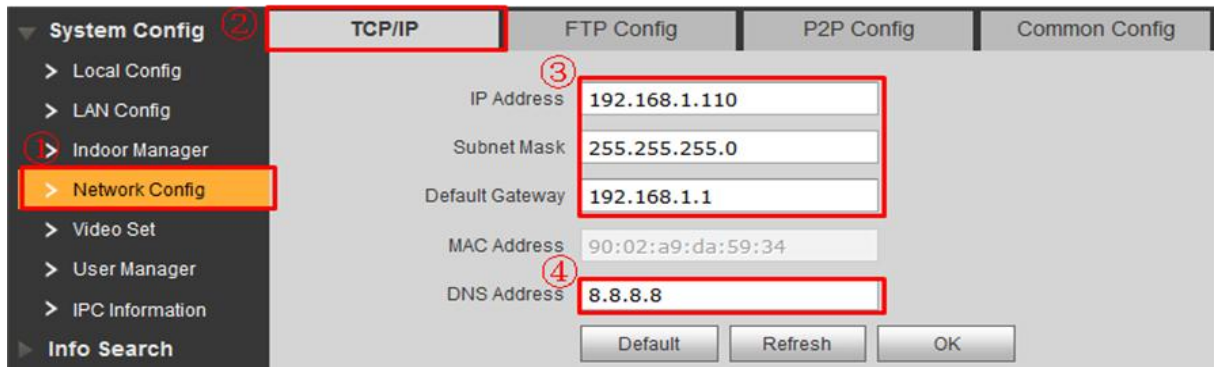

Figure 4-1

- b) Go to P2P interface; check the box to enable the P2P function. Please wait until the status becomes on. See Figure 4-2.



Figure 4-2

4.2 Cell Phone Settings

- a) Scan the QR code to download the APP. See Figure 4-3.



APP for iPhone OS



APP for Android OS

Figure 4-3

- b) Use the cell phone to scan the QR code of VTO on the device's label or Web. See Figure 4-4 and Figure 4-5.



Figure 4-4

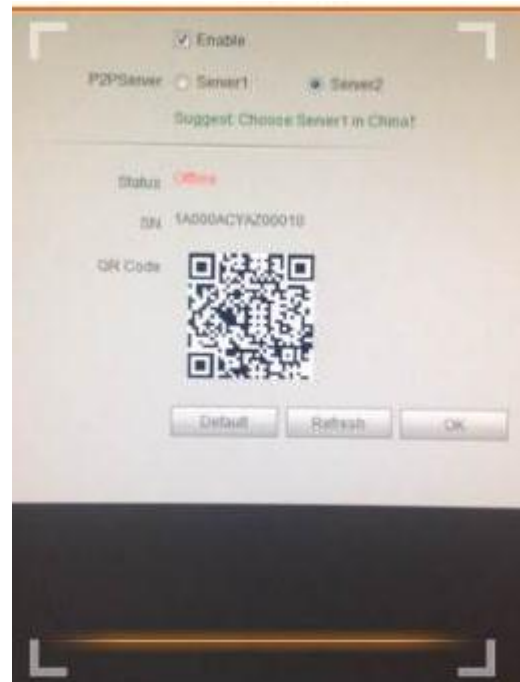
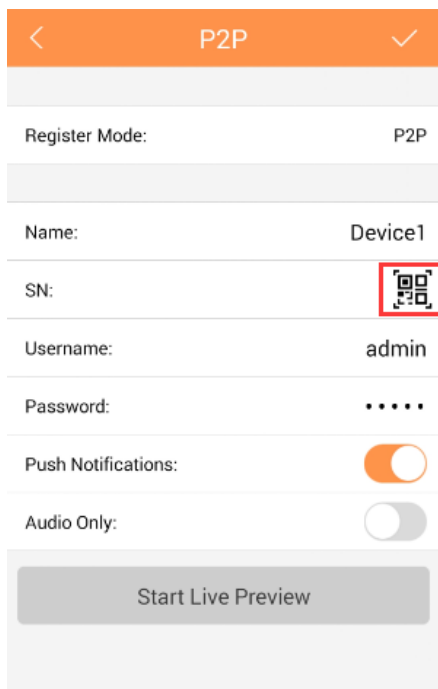

Figure 4-5

- c) Give a name to VTO first. Click the detect VTO. You can view the corresponding video from the VTO after it detects the device.

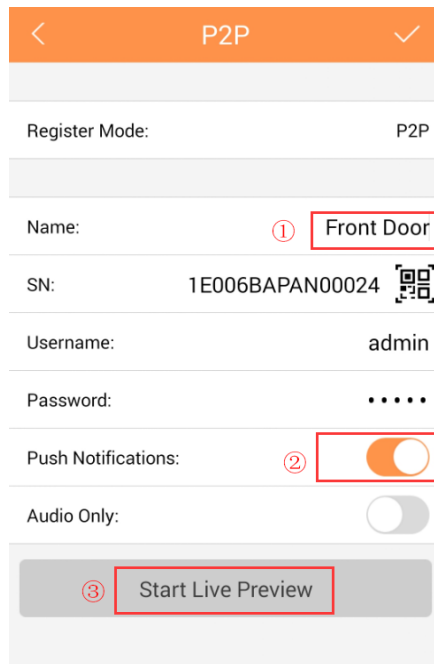

Figure 4-6

4.3 Check Results

When the VTO is calling the VTH, you can see a push message on your cell phone. Open the message; you can see the video from the VTO.



Figure 4-7



5 Installation

5.1 VTO Installation

This VTO2000A series product supports direction installation and embedded in wall installation.

5.1.1 Direct Installation

- a) Install metal bracket into the groove on wall. Secure 4 fasten screw (ST4.2x25), and fix metal bracket on wall. See Figure 5- .

Component Name	Icon	No.
ST4.2x25 Cross recessed pan head tail tapping screws -stainless		4
FEC5-30 plastic expansion bolt		4

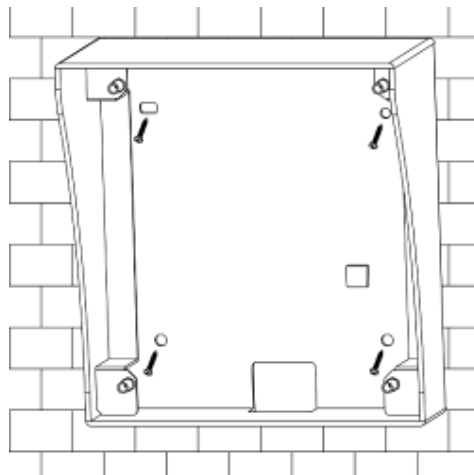

Figure 5- 1

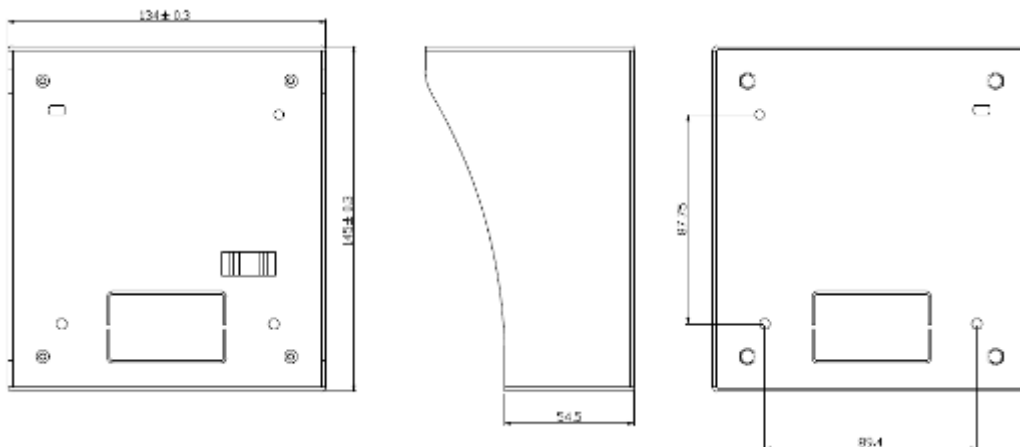



Figure 5-2

- b) Align the device on metal bracket according to screw hole. Fasten screw (M3x8 Cross recessed countersunk head tail machine screws --- galvanizing white), and fix device on metal bracket. See Figure 5- 1.

Component Name	Icon	No.
M3x8 Cross recessed countersunk head tail machine screws --- galvanizing white		4
M3x6 Hex slot pan head tail machine screws --- galvanizing white		4

Tips:

M3x6 or M3x8 either is OK.

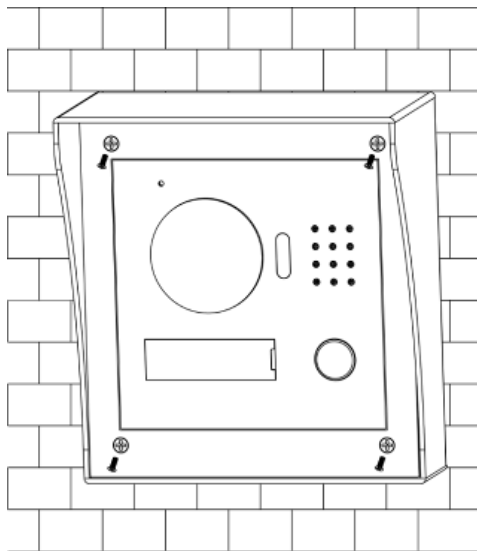

Figure 5- 1

5.1.2 Embedded in Wall

a) Dig a hole on wall, its dimension is 117*128*80(mm).See Figure 5- .

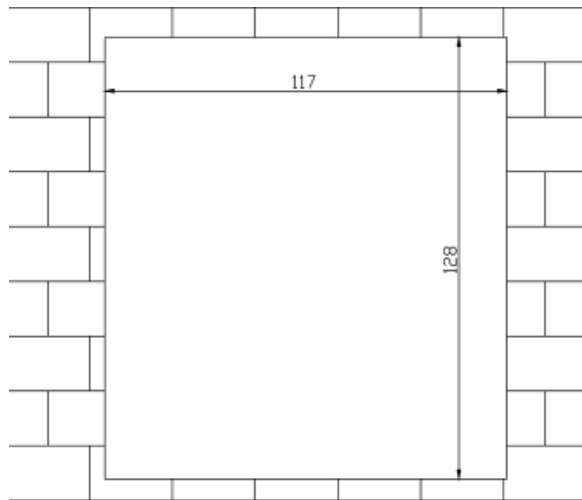

Figure 5- 4

b) Embed metal bracket into wall until its four peaks lean against the wall. See Figure 5- 2.

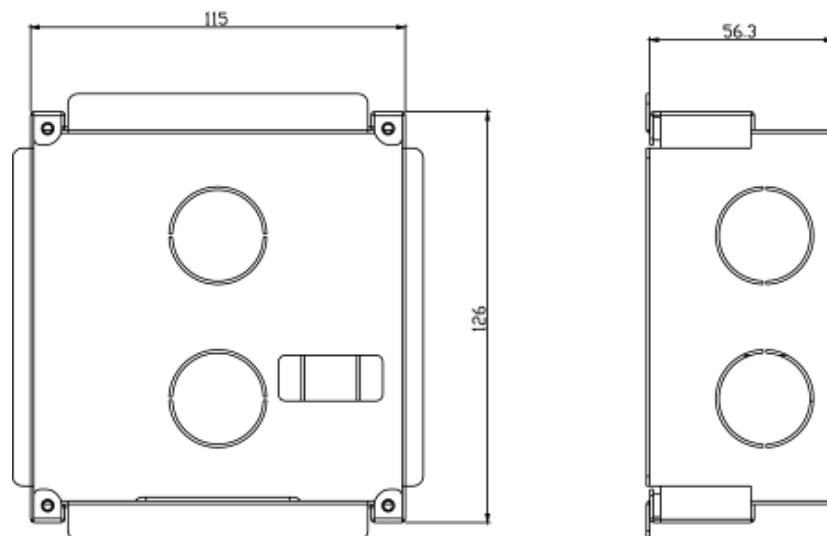

Figure 5-5

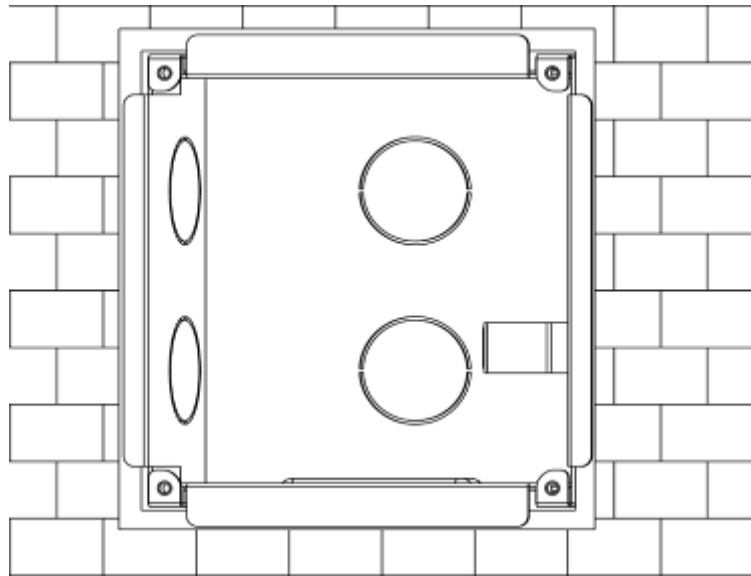



Figure 5- 2

- c) Align the device on metal bracket according to screw hole. Fasten screws (M3×8 Cross recessed countersunk head tail machine screws --- galvanizing white), and fix device on metal bracket. See Figure 5- 3.

Component Name	Icon	No.
M3×8 Cross recessed countersunk head tail machine screws --- galvanizing white		4
M3×6 Hex slot pan head tail machine screws --- galvanizing white		4

Tips:

M3x6 or M3x8 either is OK.

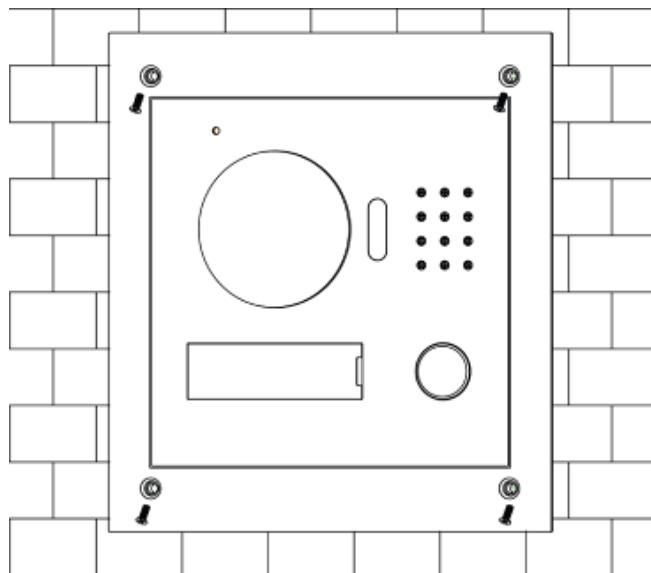

Figure 5- 3

5.2 VTH Installation

Important

The center of the device shall be 1400mm-1600mm height from the ground.

5.2.1 Installation Mode 1

- Secure the installation bracket on the wall. Use three M4×30 screws to fix.
- Fix the device on the installation bracket and then use the clip to secure. See Figure 5-1.

Component Name	Icon	No.
M4×30 crosshead pan head thread		3

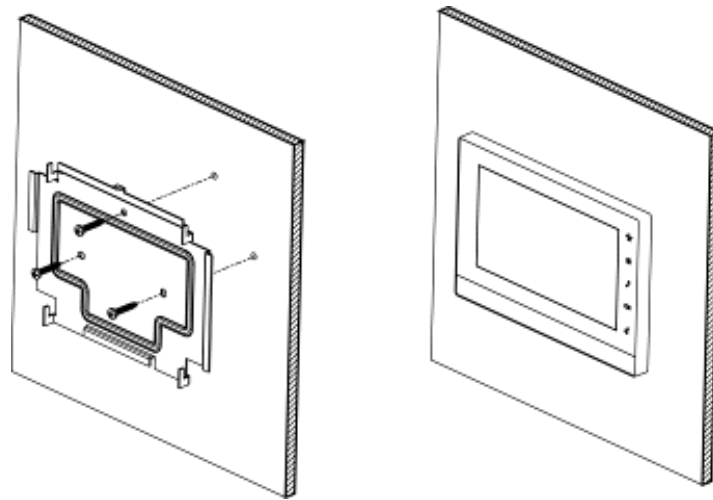



Figure 5-1

5.2.2 Installation Mode 2

- Secure the installation bracket on the wall. Use thirty-two M4×30 screws to fix.
- Fix the device on the installation bracket and then use the clip to secure. See Figure 5-2.

Component Name	Icon	No.
M4×30 crosshead pan head thread		2

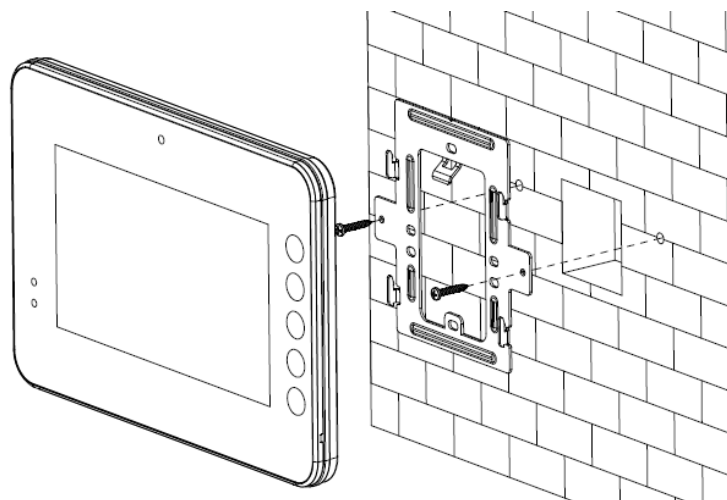

Figure 5-2

6 Electric Lock and Magnetic Door Lock

6.1 Electric Door Lock

When connect the VTO to the electric door lock, connect the positive end of the electric door lock to the NO of the VTO, connect the negative end of the electric door lock to the public end.

When connect to the on-off button, connect one end of the on-off button to the one end of the on-off button of the VTO, and then connect the other end of the on-off button to the GND of VTO.

See Figure 6-1.

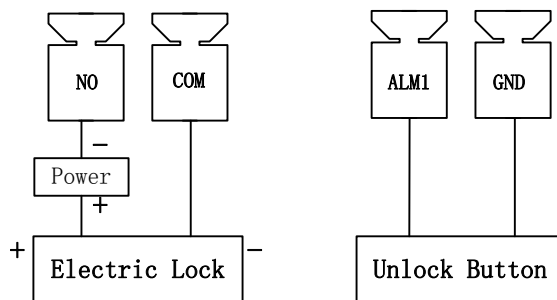

Figure 6-1

6.2 Magnetic Door Lock

When connect the VTO to the magnetic door lock, connect the positive end of the magnetic door lock to the NC of the VTO, connect the negative end of the magnetic door lock to the public end.

When connect to the magnetic door lock feedback, connect one end of the feedback to the one end of the feedback of the VTO, and then connect the other end of the feedback to the GND of VTO. See Figure 6-2.

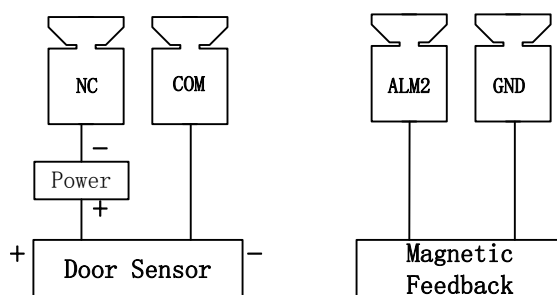

Figure 6-2

7 Appendix Specifications

Model	VTH1550CH/VTH1550CHW-2	VTH1560B/VTH1560BW
OS		
Main processor	Embedded micro controller	
OS	Embedded LINUX OS	
Video		
Video compression standard	H.264	
Resolution	800×480	
Audio		
Input	All-direction microphone	
Output	Built-in speaker	
Audio talk	Dual-way bidirectional talk	
Display		
Monitor dimensions	7-inch TFT true color screen	
Operation mode		
Input	Touch buttons	
Alarm		
Alarm Input	6-channel local alarm input	8-channel local alarm input
Alarm Output	1-channel local alarm output	N/A
Network		
Ethernet Network	10M/100Mbps self-adaptive	
Network protocol	TCP/IP	
Specifications		
Power	DC 10~15V or special switch to provide power directly	
Power consumption	Standby≤1.5W ; working≤7W	
Working environment	-10℃~+60℃	
	10%~90%RH	
Dimensions (L×W×H)	200mm×136mm×22 mm	221mm×154mm×25mm
Weight	0.8kg	

Model		VTO2000A/VTO2000A-2
System	Main Process	Embedded micro controller
	OS	Embedded Linux OS
Video	Video Compression Standard	H.264
	Input/Sensor	Megapixel CMOS HD camera
	Night Vision	Support
Audio	Input	All-direction microphone
	Output	Built-in speaker
	Talk	Support bidirectional talk
Operation Mode	Input	Single key input
	Door Lock Status Check	Support (optional)
Network	Ethernet	10M/100Mbps self-adaptive
	Network Protocol	TCP/IP
General	Power	DC 10V~15V or special switch to provide power directly
	Consumption	Standby ≤1W; working ≤10W
	Working Temperature	- 30°C ~+60°C
	Relative Humidity	10%~90%RH
	Dimensions (L×W×H)	129.9mm×32.2mm×140mm
	Weight	0.5kg

Note

- All interface for reference only. Slight difference may be found in user interface.
- All the designs and software here are subject to change without prior written notice.
- All trademarks and registered trademarks mentioned are the properties of their respective owners.
- If there is any uncertainty or controversy, please refer to the final explanation of us.
- Please visit our website for more information.

