

Standards EN62040-2: 2006

TEST REPORT

For

INVT POWER SYSTEM (SHENZHEN) CO., LTD.

Uninterruptible Power Supply

Model Number: HT33030XL, HT33030XS, HT33020XL, HT33020XS,
HT33015XL, HT33015XS, HT33010XL, HT33010XS

Prepared for : INVT POWER SYSTEM (SHENZHEN) CO., LTD.
Address : 5th Floor, 1# Building, Gaofa Industrial Park, Longjing,
Nanshan District, Shenzhen, China, 518055

Prepared by : EMTEK(SHENZHEN) CO., LTD..
Address : Bldg 69, Majialong Industry Zone,
Nanshan District, Shenzhen, Guangdong, China

Tel: (0755) 26954280
Fax: (0755) 26954282

Report Number : ES160523064E
Date of Test : January 20, 2015 to February 05, 2015
Date of Report : May 24, 2016

TABLE OF CONTENT

Description	Page
1. SUMMARY OF TEST RESULT.....	7
2. GENERAL INFORMATION.....	8
2.1. Description of Device (EUT).....	8
2.2. Description of Test Facility.....	10
2.3. Measurement Uncertainty.....	10
3. MEASURING DEVICE AND TEST EQUIPMENT.....	11
3.1. For Conducted Emission Measurement.....	11
3.2. For Radiated Emission Measurement.....	11
3.3. For Electrostatic Discharge Immunity Test.....	12
3.4. For RF Strength Susceptibility Test.....	12
3.5. For Electrical Fast Transient/Burst Immunity Test.....	12
3.6. For Surge Immunity Test.....	13
3.7. For Injected Current Susceptibility Test.....	13
3.8. For Magnetic Field Immunity Test.....	13
3.9. For Voltage Dips and Interruptions Test.....	13
3.10. Low Frequency Signals Test.....	13
4. CONDUCTED EMISSION MEASUREMENT.....	14
4.1. Block Diagram of Test Setup.....	14
4.2. Measuring Standard.....	14
4.3. Power Line Conducted Emission Limits (C3).....	14
4.4. EUT Configuration on Measurement.....	14
4.5. Operating Condition of EUT.....	15
4.6. Test Procedure.....	15
4.7. Measuring Results.....	15
5. RADIATED EMISSION MEASUREMENT.....	24
5.1. Block Diagram of Test.....	24
5.2. Measuring Standard.....	24
5.3. Radiated Emission Limits(C3).....	25
5.4. EUT Configuration on Test.....	25
5.5. Operating Condition of EUT.....	25
5.6. Test Procedure.....	25
5.7. Measuring Results.....	25
6. IMMUNITY PERFORMANCE CRITERIA DESCRIPTION.....	30
7. ELECTROSTATIC DISCHARGE IMMUNITY TEST.....	46
7.1. Block Diagram of Test Setup.....	46
7.2. Test Standard.....	46
7.3. Severity Levels and Performance Criterion.....	46
7.4. EUT Configuration.....	47
7.5. Operating Condition of EUT.....	47
7.6. Test Procedure.....	47
7.7. Test Results.....	47
8. RF FIELD STRENGTH SUSCEPTIBILITY TEST.....	49
8.1. Block Diagram of Test.....	49
8.2. Test Standard.....	49
8.3. Severity Levels and Performance Criterion.....	50
8.4. EUT Configuration on Test.....	50
8.5. Operating Condition of EUT.....	50

8.6. Test Procedure.....	50
8.7. Test Results.....	50
9. ELECTRICAL FAST TRANSIENT/BURST IMMUNITY TEST.....	52
9.1. Block Diagram of Test Setup.....	52
9.2. Test Standard.....	52
9.3. Severity Levels and Performance Criterion.....	52
9.4. EUT Configuration.....	53
9.5. Operating Condition of EUT.....	53
9.6. Test Procedure.....	53
9.7. Test Result.....	53
10. SURGE IMMUNITY TEST.....	55
10.1. Block Diagram of Test Setup.....	55
10.2. Test Standard.....	55
10.3. Severity Levels and Performance Criterion.....	55
10.4. EUT Configuration.....	56
10.5. Operating Condition of EUT.....	56
10.6. Test Procedure.....	56
10.7. Test Result.....	56
11. INJECTED CURRENTS SUSCEPTIBILITY TEST.....	58
11.1. Block Diagram of Test Setup.....	58
11.2. Test Standard.....	58
11.3. Severity Levels and Performance Criterion.....	58
11.4. EUT Configuration.....	59
11.5. Operating Condition of EUT.....	59
11.6. Test Procedure.....	59
11.7. Test Results.....	59
12. MAGNETIC FIELD SUSCEPTIBILITY TEST.....	61
12.1. Block Diagram of Test.....	61
12.2. Test Standard.....	61
12.3. Severity Levels and Performance Criterion.....	61
12.4. EUT Configuration on Test.....	62
12.5. Test Procedure.....	62
12.6. Test Results.....	62
13. VOLTAGE DIPS AND INTERRUPTIONS TEST.....	64
13.1. Block Diagram of Test Setup.....	64
13.2. Test Standard.....	64
13.3. Severity Levels and Performance Criterion.....	64
13.4. EUT Configuration.....	65
13.5. Operating Condition of EUT.....	65
13.6. Test Procedure.....	65
13.7. Test Result.....	65
14. LOW FREQUENCY SIGNALS TEST.....	67
14.1. Block Diagram of Test Setup.....	67
14.2. Test Standard.....	67
14.3. Operating Condition of EUT.....	67
14.4. Test Results.....	67
15. TEST PHOTOGRAPH.....	69
15.1. Photos of Conducted Emission Measurement.....	69
15.2. Photo of Radiation Emission Measurement.....	70
15.3. Photo of Electrostatic Discharge Test.....	71
15.4. Photo of RF Field Strength susceptibility Test.....	71
15.5. Photos of Electrical Fast Transient/Burst Test.....	72
15.6. Photo of Surge Test.....	72
15.7. Photo of Injected Currents Susceptibility Test.....	73
15.8. Photo of Magnetic Field Immunity Test.....	73

15.9. Photo of Voltage dips and interruption Test..... 74
15.10. Photo of Low Frequency Signals Test..... 74

APPENDIX (Photos of EUT) (12 Pages)



中国认可
国际互认
检测
TESTING
CNAS L2291



TEST REPORT VERIFICATION

Applicant : INVT POWER SYSTEM (SHENZHEN) CO., LTD.
 Manufacturer : INVT POWER SYSTEM (SHENZHEN) CO., LTD.
 EUT : Uninterruptible Power Supply
 Trademark : INVT
 Model Number : HT33030XL, HT33030XS, HT33020XL, HT33020XS, HT33015XL, HT33015XS,
 HT33010XL, HT33010XS
 Power Supply : Please refer to page 8

Measurement Procedure Used:

EN62040-2: 2006,
 EN 61000-3-12: 2011
 EN 61000-3-11: 2000
 (IEC 61000-4-2:2008, IEC 61000-4-3:2006+A1:2007+A2:2010, IEC 61000-4-4:2012,
 IEC 61000-4-5:2014, IEC 61000-4-6:2013, IEC 61000-4-8:2009, IEC 61000-4-11:2004,
 IEC 61000-2-2:2002)

The device described above is tested by EMTEK(SHENZHEN) CO., LTD.. to determine the maximum emission levels emanating from the device and the severe levels of the device can endure and its performance criterion. The measurement results are contained in this test report and EMTEK(SHENZHEN) CO., LTD.. is assumed full of responsibility for the accuracy and completeness of these measurements. Also, this report shows that the EUT (Equipment Under Test) is technically compliant with the EN 62040-2 requirements.

This report applies to above tested sample only and shall not be reproduced in part without written approval of EMTEK(SHENZHEN) CO., LTD..

Date of Test : January 20, 2015 to February 05, 2015

Prepared by : Bunny Zhang
 Bunny Zhang/Editor

Reviewer : Jessie Hu
 Jessie Hu/Supervisor

Approved & Authorized Signer : Lisa Wang
 Lisa Wang/Manager

Modified Information

Version	Report No.	Revision Date	Summary
V1.0	ES141231441E	/	Original Report
V1.0	ES160523064E	May 24, 2016	Update EMC directive and Standard

1. SUMMARY OF TEST RESULT

EMISSION			
Description of test item	Standard	Limits	Results
Conducted disturbance at mains terminals	EN62040-2: 2006	C3	Pass
Radiated Disturbance	EN62040-2: 2006	C3	Pass
Harmonic Current Emissions	EN 61000-3-12: 2011	Class A	Pass
Voltage Fluctuation and Flicker	EN 61000-3-11: 2000	Section 5	Pass
Immunity			
Description of test item	Basic Standard	Performance Criteria	Results
Electrostatic Discharge (ESD)	IEC 61000-4-2:2008	B	Pass
Radio-frequency, Continuous radiated disturbance	IEC 61000-4-3:2006+A1:2007+A2:2010	A	Pass
EFT/B Immunity	IEC 61000-4-4:2012	B	Pass
Surge Immunity	IEC 61000-4-5:2014	B	Pass
Conducted RF Immunity	IEC 61000-4-6:2013	A	Pass
Power frequency magnetic field	IEC 61000-4-8:2009	A	Pass
Voltage dips and Voltage interruptions	IEC 61000-4-11:2004	B	Pass
Low Frequency signals	IEC 61000-2-2:2002	A	Pass
Note: /			

2. GENERAL INFORMATION

2.1. Description of Device (EUT)

EUT	:	Uninterruptible Power Supply
Model Number	:	HT33030XL, HT33030XS, HT33020XL, HT33020XS, HT33015XL, HT33015XS, HT33010XL, HT33010XS (Note: These models are identical in circuitry and electrical, mechanical and physical construction; the only differences are the output rating and model number. for trading purpose. We prepare HT33030XL for test.)
Input Rating	:	<p>HT33010XS: AC Input : 380/400/415VAC, 3ϕ+N+PE, 50Hz/60Hz, 15Amax, Batt Input: \pm240Vdc, 20Amax</p> <p>HT33010XL: AC Input : 380/400/415VAC, 3ϕ+N+PE, 50Hz/60Hz, 15Amax, Batt Input: \pm240Vdc, 20Amax</p> <p>HT33015XS: AC Input : 380/400/415VAC, 3ϕ+N+PE, 50Hz/60Hz, 22Amax, Batt Input: \pm240Vdc, 30Amax</p> <p>HT33015XL: AC Input : 380/400/415VAC, 3ϕ+N+PE, 50Hz/60Hz, 22Amax, Batt Input: \pm240Vdc, 30Amax</p> <p>HT33020XS: AC Input : 380/400/415VAC, 3ϕ+N+PE, 50Hz/60Hz, 29Amax, Batt Input: \pm240Vdc, 40Amax</p> <p>HT33020XL: AC Input : 380/400/415VAC, 3ϕ+N+PE, 50Hz/60Hz, 29Amax, Batt Input: \pm240Vdc, 40Amax</p> <p>HT33030XS: AC Input : 380/400/415VAC, 3ϕ+N+PE, 50Hz/60Hz, 44Amax, Batt Input: \pm240Vdc, 60Amax</p> <p>HT33030XL: AC Input : 380/400/415VAC, 3ϕ+N+PE, 50Hz/60Hz, 44Amax, Batt Input: \pm240Vdc, 60Amax</p>

Output Rating : HT33010XS:
380/400/415VAC,
3ø+N+PE, 50Hz/60Hz, 10kVA/9kW

HT33010XL:
380/400/415VAC,
3ø+N+PE, 50Hz/60Hz, 10kVA/9kW

HT33015XS:
380/400/415VAC,
3ø+N+PE, 50Hz/60Hz, 15kVA/13.5kW

HT33010XI:
380/400/415VAC,
3ø+N+PE, 50Hz/60Hz, 15kVA/13.5kW

HT33020XS:
380/400/415VAC,
3ø+N+PE, 50Hz/60Hz, 20kVA/18kW

HT33020XL:
380/400/415VAC,
3ø+N+PE, 50Hz/60Hz, 20kVA/18kW

HT33030XS:
380/400/415VAC,
3ø+N+PE, 50Hz/60Hz, 30kVA/27kW

HT33030XL:
380/400/415VAC,
3ø+N+PE, 50Hz/60Hz, 30kVA/27kW

Test voltage : AC 380V/50Hz

Applicant : INVT POWER SYSTEM (SHENZHEN) CO., LTD.

Address : 5th Floor, 1# Building, Gaofa Industrial Park, Longjing, Nanshan District, Shenzhen, China, 518055

Manufacturer : INVT POWER SYSTEM (SHENZHEN) CO., LTD.

Address : 5th Floor, 1# Building, Gaofa Industrial Park, Longjing, Nanshan District, Shenzhen, China, 518055

Date of receiver : January 20, 2015

Date of Test : January 20, 2015 to February 05, 2015

2.2. Description of Test Facility

Site Description

EMC Lab. : Accredited by CNAS, 2013.10.29
 The certificate is valid until 2016.10.28
 The Laboratory has been assessed and proved to be in compliance with CNAS-CL01: 2006 (identical to ISO/IEC17025: 2005)
 The Certificate Registration Number is L2291.

Accredited by TUV Rheinland Guangzhou 2010.5.25
 The Laboratory has been assessed according to the requirements ISO/IEC 17025

Accredited by FCC, April 17, 2013
 The Certificate Registration Number. is 709623.

Accredited by Industry Canada, November 15, 2010
 The Certificate Registration Number. is 46405-4480

Name of Firm : EMTEK(SHENZHEN) CO., LTD.
 Site Location : Bldg 69, Majialong Industry Zone,
 Nanshan District, Shenzhen, Guangdong, China

2.3. Measurement Uncertainty

Test Item	Uncertainty
Conducted Emission Uncertainty	: 3.16dB(9k~150kHz Conduction 2#) 2.90dB(150k-30MHz Conduction 2#)
Radiated Emission Uncertainty (10m Chamber)	: 3.96dB (30M~1GHz Polarize: H) 4.04dB (30M~1GHz Polarize: V)
Uncertainty for C/S Test	: 1.45(Using CDN Test)
Uncertainty for R/S Test	: 2.10dB(80MHz-200MHz) 1.76dB(200MHz-1000MHz)
Uncertainty for test site temperature and humidity	: 0.6°C 4%

3. MEASURING DEVICE AND TEST EQUIPMENT

3.1. For Conducted Emission Measurement

Used	Equipment	Manufacturer	Model No.	Serial No.	Last Cal.	Cal. Interval
<input checked="" type="checkbox"/>	Test Receiver	Rohde & Schwarz	ESCS30	828985/018	May 17, 2014	1 Year
<input checked="" type="checkbox"/>	L.I.S.N.	Schwarzbeck	NNLK8129	8129-203	May 17, 2014	1 Year
<input type="checkbox"/>	L.I.S.N.	ROHDE & SCHWARZ	ESH3-Z6	100011	May 17, 2014	1 Year
<input type="checkbox"/>	L.I.S.N.	ROHDE & SCHWARZ	ESH3-Z6	100253	May 17, 2014	1 Year
<input type="checkbox"/>	L.I.S.N.	ROHDE & SCHWARZ	ESH3-Z5	100191	May 17, 2014	1 Year
<input checked="" type="checkbox"/>	50Ω Coaxial Switch	Anritsu	MP59B	M20531	N/A	N/A
<input checked="" type="checkbox"/>	Pulse Limiter	Rohde & Schwarz	ESH3-Z2	100006	May 17, 2014	1 Year
<input type="checkbox"/>	Current probe	Rohde & Schwarz	EZ-17	0816.2063.02	May 17, 2014	1 Year

3.2. For Radiated Emission Measurement

Used	Equipment	Manufacturer	Model No.	Serial No.	Last Cal.	Cal. Interval
<input checked="" type="checkbox"/>	EMI TEST RECEIVER	R&S/DE	ESR3	1316.300K03-10 1707-Z1 1316.3003K03-1 01706-HN	May 17, 2014	1Year
<input type="checkbox"/>	EMI TEST RECEIVER	R&S/DE	ESC13	1166.5950K03-1 01384-Bw	May 17, 2014	1Year
<input type="checkbox"/>	Frequency Analyser	R&S/DE	FSV40	132.1.3008K39-1 00967-AP	May 17, 2014	1Year
<input checked="" type="checkbox"/>	Broadband Antenna(30M-3GHz)	Schwarzbeck/DE	VULP9163	659/660/661	May 17, 2014	1Year
<input type="checkbox"/>	Horn Antenna(1G-18GHz)	Schwarzbeck/DE	BBHA9120D	1177/1178	May 17, 2014	1Year
<input type="checkbox"/>	Horn Antenna (15G-26.5GHz)	Schwarzbeck/DE	BBHA9170	547	May 17, 2014	1Year
<input type="checkbox"/>	Horn Antenna (26.5G-40GHz)	AHS/USA	SAS-573	184/185	May 17, 2014	1Year
<input checked="" type="checkbox"/>	Pre-Amplifier (10M-1GHz 40dB)	Lunar EM	PM01-1-40	N/A	May 17, 2014	1Year
<input type="checkbox"/>	Pre-Amplifier (1G-18GHz 40dB)	Lunar EM	PM1-18-40	J101121229001	May 17, 2014	1Year
<input type="checkbox"/>	Pre-Amplifier (1G-18GHz 48dB)	Lunar EM	PM1-18-48	DS131115120D1 177	May 17, 2014	1Year
<input type="checkbox"/>	Pre-Amplifier (18G-26.5GHz 40dB)	Lunar EM	PM18-26-40	J1012131010001	May 17, 2014	1Year
<input type="checkbox"/>	Pre-Amplifier (18G-26.5GHz 48dB)	Lunar EM	PM18-26-48	J1013131010001	May 17, 2014	1Year

3.3. For Harmonic Current / Flicker Measurement

Used	Equipment	Manufacturer	Model No.	Serial No.	Last Cal.	Cal. Interval
<input checked="" type="checkbox"/>	45KVA AC Power source	Teseq/Germany	NSG 1007-45/45KVA	1305A02873	May 17, 2014	1 Year
<input checked="" type="checkbox"/>	Signal conditioning Unit	Teseq/Germany	CCN 1000-3	1305A02873	May 17, 2014	1 Year
<input checked="" type="checkbox"/>	Three phase impedance network	Teseq/Germany	INA2197/37A	1305A02873	May 17, 2014	1 Year
<input checked="" type="checkbox"/>	Three phase impedance network	Teseq/Germany	INA 2196/75A	1305A02874	May 17, 2014	1 Year
<input type="checkbox"/>	Proflin 2100 AC Switching Unit	Teseq/Germany	NSG2200-3	A22714	May 17, 2014	1 Year

3.4. For Electrostatic Discharge Immunity Test

Used	Equipment	Manufacturer	Model No.	Serial No.	Last Cal.	Cal. Interval
<input checked="" type="checkbox"/>	ESD Tester	TESEQ AG	NSG 438A	130	May 17, 2014	1 Year
<input checked="" type="checkbox"/>	Impulse Module	TESEQ AG	INA 4380-150pF/330Ohm	403-550/1712	May 17, 2014	1 Year

3.5. For RF Strength Susceptibility Test

Used	Equipment	Manufacturer	Model No.	Serial No.	Last Cal.	Cal. Interval
<input checked="" type="checkbox"/>	Signal Generator	Agilent	N5181A	MY50145187	May 17, 2014	1 Year
<input checked="" type="checkbox"/>	RF Power Meter. Dual Channel	BOONTON	4232A	10539	May 17, 2014	1 Year
<input checked="" type="checkbox"/>	50ohm Diode Power Sensor	BOONTON	51011EMC	34236/34238	May 17, 2014	1 Year
<input checked="" type="checkbox"/>	Field Strength Meter	DARE	RSS1006A	10I00037SO 22	May 17, 2014	1 Year
<input checked="" type="checkbox"/>	50ohm Diode Power Sensor	BOONTON	51011EMC	36164	May 17, 2014	1 Year
<input checked="" type="checkbox"/>	Power Amplifier	MILMEGA	80RF1000-1 75	1059345	May 17, 2014	1 Year
<input type="checkbox"/>	Power Amplifier	MILMEGA	AS0102-55	1018770	May 17, 2014	1 Year
<input checked="" type="checkbox"/>	Power Amplifier	MILMEGA	AS1860-50	1059346	May 17, 2014	1 Year
<input checked="" type="checkbox"/>	Log.-Per. Antenna	SCHWARZBECK	VULP 9118E	N/A	May 17, 2014	1 Year
<input type="checkbox"/>	Broad-Band Horn Antenna	SCHWARZBECK	STLP 9149	9149-227	May 17, 2014	1 Year
<input checked="" type="checkbox"/>	Multi-function interface system	DARE	CTR1009B	12I00250SN O72	N/A	N/A
<input checked="" type="checkbox"/>	Automatic switch group	DARE	RSW1004A	N/A	N/A	N/A

3.6. For Electrical Fast Transient/Burst Immunity Test

Used	Equipment	Manufacturer	Model No.	Serial No.	Last Cal.	Cal. Interval
<input checked="" type="checkbox"/>	Burst Tester	HAEFELY	PEFT4010	080981-16	May 17, 2014	1Year
<input type="checkbox"/>	Coupling Clamp	HAEFELY	IP-4A	147147	May 17, 2014	1Year
<input checked="" type="checkbox"/>	Three phase CDN	Teseq	CDN 163	202	May 17, 2014	1 Year

3.7. For Surge Immunity Test

Used	Equipment	Manufacturer	Model No.	Serial No.	Last Cal.	Cal. Interval
<input checked="" type="checkbox"/>	Surge Controller	HAEFELY	Psurge 8000	174031	May 17, 2014	1Year
<input checked="" type="checkbox"/>	Impulse Module	HAEFELY	PIM 100	174124	May 17, 2014	1Year
<input checked="" type="checkbox"/>	Coupling Decoupling Filter	HAEFELY	PCD 130	172181	May 17, 2014	1Year

3.8. For Injected Current Susceptibility Test

Used	Equipment	Manufacturer	Model No.	Serial No.	Last Cal.	Cal. Interval
<input checked="" type="checkbox"/>	Simulator	FRANKONIA	CIT-10	126B1210120 12	May 17, 2014	1 Year
<input type="checkbox"/>	CDN	EMTEST	CDN-M2	5100100100	May 17, 2014	1 Year
<input checked="" type="checkbox"/>	CDN	EMTEST	CDN-M3	0900-11	May 17, 2014	1 Year
<input type="checkbox"/>	Injection Clamp	EMTEST	F-2031-23MM	368	May 17, 2014	1Year
<input checked="" type="checkbox"/>	Attenuator	EMTEST	ATT6	0010222A	May 17, 2014	1Year
<input type="checkbox"/>	Three phase CDN	Teseq	CDN M332S	32655	May 17, 2014	1 Year
<input type="checkbox"/>	Three phase CDN	Teseq	CDN M432S	33670	May 17, 2014	1 Year
<input type="checkbox"/>	Three phase CDN	Teseq	CDN M432-3LNS	34048	May 17, 2014	1 Year
<input checked="" type="checkbox"/>	Three phase CDN	Teseq	CDN M532S	33799	May 17, 2014	1 Year

3.9. For Magnetic Field Immunity Test

Used	Equipment	Manufacturer	Model No.	Serial No.	Last Cal.	Cal. Interval
<input checked="" type="checkbox"/>	Magnetic Field Tester	HAEFELY	MAG100	250040.1	May 17, 2014	1Year

3.10. For Voltage Dips and Interruptions Test

Used	Equipment	Manufacturer	Model No.	Serial No.	Last Cal.	Cal. Interval
<input checked="" type="checkbox"/>	45KVA AC Power source	Teseq/Germany	NSG 1007-45/45KVA	1305A02873	May 17, 2014	1 Year
<input checked="" type="checkbox"/>	Signal conditioning Unit	Teseq/Germany	CCN 1000-3	1305A02873	May 17, 2014	1 Year
<input checked="" type="checkbox"/>	Three phase impedance network	Teseq/Germany	INA2197/37A	1305A02873	May 17, 2014	1 Year
<input checked="" type="checkbox"/>	Three phase impedance network	Teseq/Germany	INA 2196/75A	1305A02874	May 17, 2014	1 Year
<input checked="" type="checkbox"/>	Proflin 2100 AC Switching Unit	Teseq/Germany	NSG2200-3	A22714	May 17, 2014	1 Year

3.11. Low Frequency Signals Test

Used	Equipment	Manufacturer	Model No.	Serial No.	Last Cal.	Cal. Interval
<input checked="" type="checkbox"/>	Programmable AC Source	CHROMA	6530	/	May 17, 2014	1Year

4. CONDUCTED EMISSION MEASUREMENT

4.1. Block Diagram of Test Setup

For AC Mains:

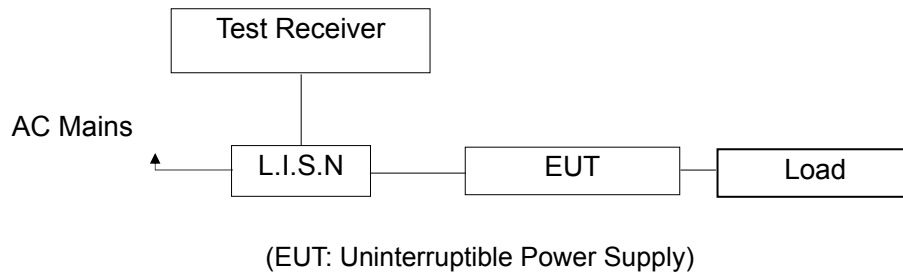

4.2. Measuring Standard

EN62040-2: 2006, Category C3

4.3. Power Line Conducted Emission Limits (C3)

UPS rated output current A	Frequency range MHz	Limits dB (μ V)	
		Quasi-peak	Average
>16 – 100	0,15 to 0,50 ^b	100	90
	0,50 to 5,0 ^b	86	76
	5,0 to 30,0	90 to 70 ^a	80 to 60 ^a
>100	0,15 to 0,50 ^b	130	120
	0,50 to 5,0 ^b	125	115
	5,0 to 30,0	115	105

^a The limits decrease linearly with the logarithm of the frequency.
^b The lower limit shall apply at the transition frequency.

4.4. EUT Configuration on Measurement

The following equipments are installed on Conducted Emission Measurement to meet EN 62040-2 requirements and operating in a manner which tends to maximize its emission characteristics in a normal application.

Uninterruptible Power Supply (EUT)
 Model Number : HT33030XL
 Serial Number : N/A

4.5. Operating Condition of EUT

- 4.5.1. Setup the EUT as shown on Section 4.1.
- 4.5.2. Turn on the power of all equipments.
- 4.5.3. Let the EUT work in measuring mode (Line mode, Battery mode) and measure it.

4.6. Test Procedure

The EUT is put on the plane 0.1m high above the ground by insulating support and connected to the AC mains through Line Impedance Stability Network (L.I.S.N). This provided a 50ohm coupling impedance for the tested equipments. Both sides of AC line are investigated to find out the maximum conducted emission according to the EN62040-2 regulations during conducted emission measurement.

The bandwidth of the field strength meter (R&S Test Receiver ESCS30) is set at 9kHz in 150kHz~30MHz and 200Hz in 9kHz~150kHz.

The frequency range from 150kHz to 30MHz is investigated.

4.7. Measuring Results

PASS.

Please refer to the following pages.

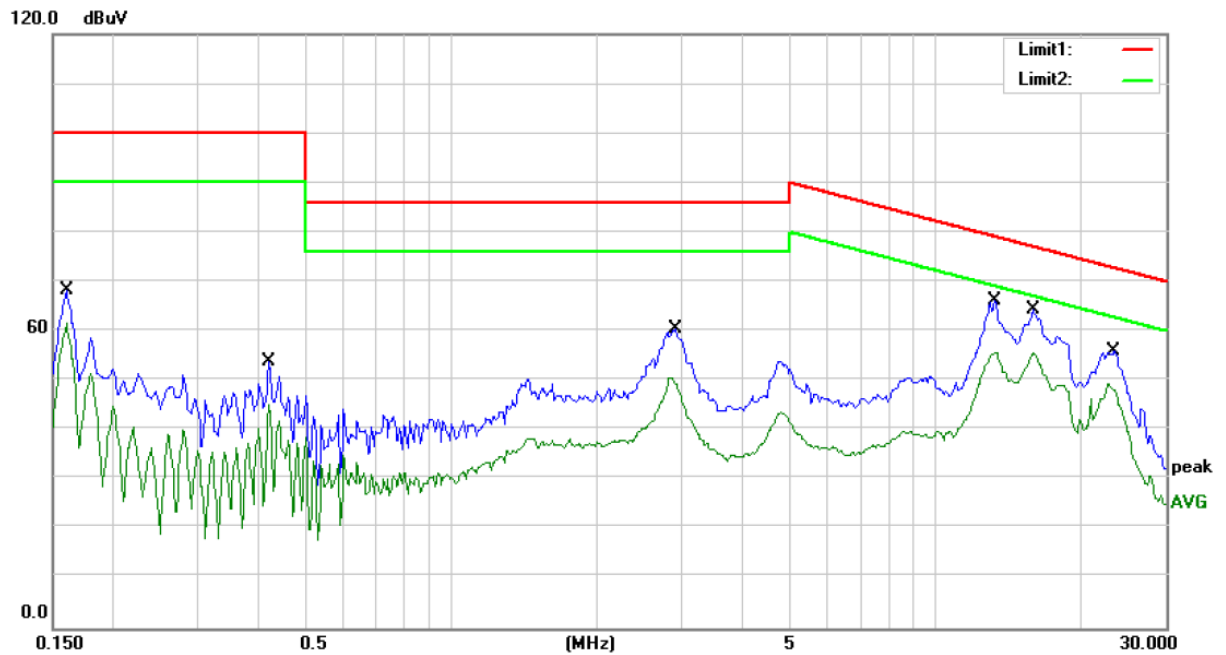

Site Conduction #2

Phase: **L1**

Temperature: 26

Limit: (CE)EN62040-2 C3_QP

Power: AC 380V/50Hz

Humidity: 55 %

Mode: FULL LOAD

Note: Line Mode

No.	Mk.	Freq.	Reading Level	Correct Factor	Measurement	Limit	Over	Detector	Comment
		MHz	dBuV	dB	dBuV	dBuV	dB		
1		0.1600	68.18	0.00	68.18	100.00	-31.82	QP	
2		0.1600	61.59	0.00	61.59	90.00	-28.41	AVG	
3		0.4200	53.86	0.00	53.86	100.00	-46.14	QP	
4		0.4200	45.04	0.00	45.04	90.00	-44.96	AVG	
5		2.9000	60.52	0.00	60.52	86.00	-25.48	QP	
6		2.9000	50.58	0.00	50.58	76.00	-25.42	AVG	
7		13.3250	66.10	0.00	66.10	79.06	-12.96	QP	
8		13.3250	55.54	0.00	55.54	69.06	-13.52	AVG	
9		15.9000	64.37	0.00	64.37	77.09	-12.72	QP	
10	*	15.9000	55.68	0.00	55.68	67.09	-11.41	AVG	
11		23.5000	55.96	0.00	55.96	72.73	-16.77	QP	
12		23.5000	49.46	0.00	49.46	62.73	-13.27	AVG	

*:Maximum data x:Over limit !:over margin Comment: Factor build in receiver. Operator: DK

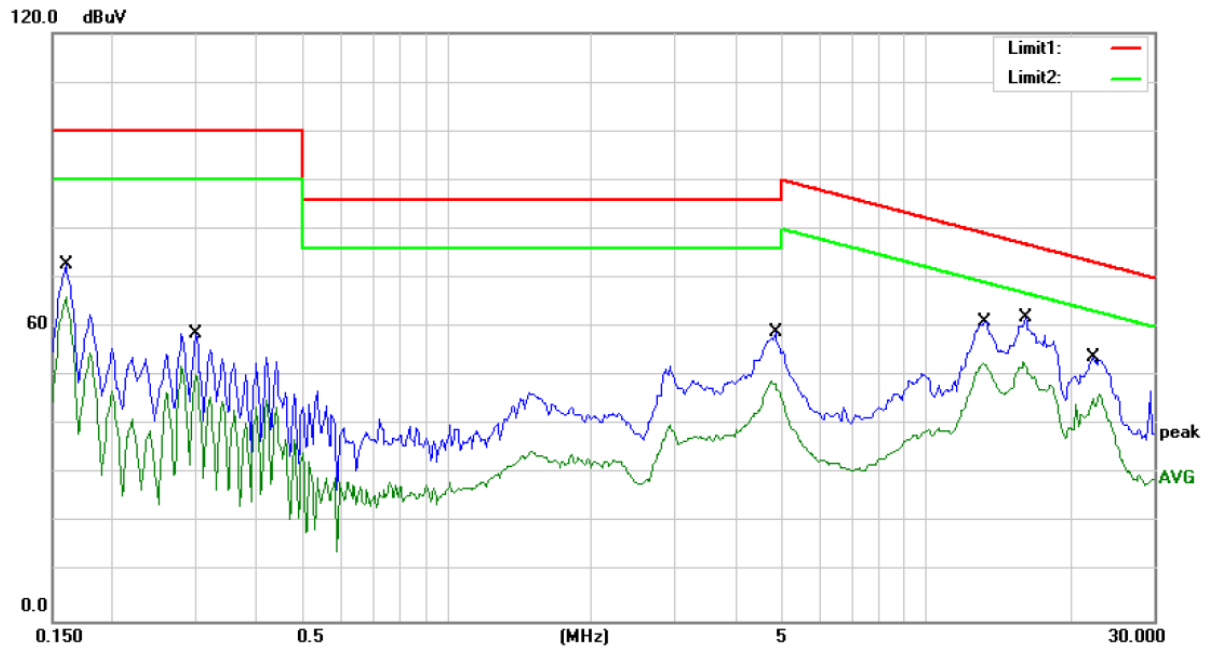

Site Conduction #2 Phase: **L2** Temperature: 26
 Limit: (CE)EN62040-2 C3_QP Power: AC 380V/50Hz Humidity: 55 %
 Mode: FULL LOAD
 Note: Line Mode

No.	Mk.	Freq.	Reading Level	Correct Factor	Measurement	Limit	Over	Detector	Comment
		MHz	dBuV	dB	dBuV	dBuV	dB		
1		0.1600	72.66	0.00	72.66	100.00	-27.34	QP	
2		0.1600	66.19	0.00	66.19	90.00	-23.81	AVG	
3		0.3000	58.62	0.00	58.62	100.00	-41.38	QP	
4		0.3000	50.38	0.00	50.38	90.00	-39.62	AVG	
5		4.8500	58.89	0.00	58.89	86.00	-27.11	QP	
6		4.8500	49.05	0.00	49.05	76.00	-26.95	AVG	
7		13.3000	61.19	0.00	61.19	79.08	-17.89	QP	
8		13.3000	52.74	0.00	52.74	69.08	-16.34	AVG	
9		16.2000	61.86	0.00	61.86	76.88	-15.02	QP	
10	*	16.2000	52.88	0.00	52.88	66.88	-14.00	AVG	
11		22.4000	53.88	0.00	53.88	73.26	-19.38	QP	
12		22.4000	46.20	0.00	46.20	63.26	-17.06	AVG	

*:Maximum data x:Over limit !:over margin Comment: Factor build in receiver. Operator: DK

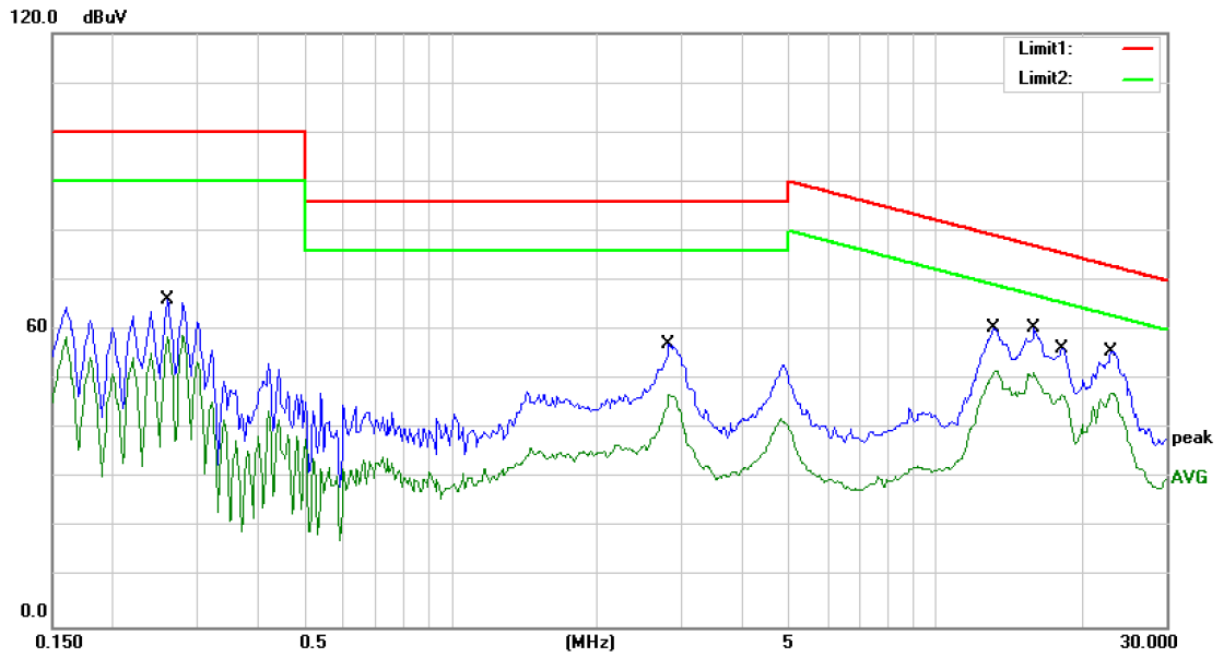

Site Conduction #2 Phase: **L3** Temperature: 26
 Limit: (CE)EN62040-2 C3_QP Power: AC 380V/50Hz Humidity: 55 %
 Mode: FULL LOAD
 Note: Line Mode

No.	Mk.	Freq.	Reading Level	Correct Factor	Measurement	Limit	Over	Detector	Comment
		MHz	dBuV	dB	dBuV	dBuV	dB		
1		0.2600	66.01	0.00	66.01	100.00	-33.99	QP	
2		0.2600	58.50	0.00	58.50	90.00	-31.50	AVG	
3		2.8200	57.13	0.00	57.13	86.00	-28.87	QP	
4		2.8200	46.90	0.00	46.90	76.00	-29.10	AVG	
5		13.3000	60.41	0.00	60.41	79.08	-18.67	QP	
6		13.3000	51.75	0.00	51.75	69.08	-17.33	AVG	
7		16.0000	60.40	0.00	60.40	77.02	-16.62	QP	
8	*	16.0000	51.41	0.00	51.41	67.02	-15.61	AVG	
9		18.2500	56.16	0.00	56.16	75.55	-19.39	QP	
10		18.2500	46.85	0.00	46.85	65.55	-18.70	AVG	
11		23.0500	55.77	0.00	55.77	72.94	-17.17	QP	
12		23.0500	47.27	0.00	47.27	62.94	-15.67	AVG	

*:Maximum data x:Over limit !:over margin Comment: Factor build in receiver. Operator: DK

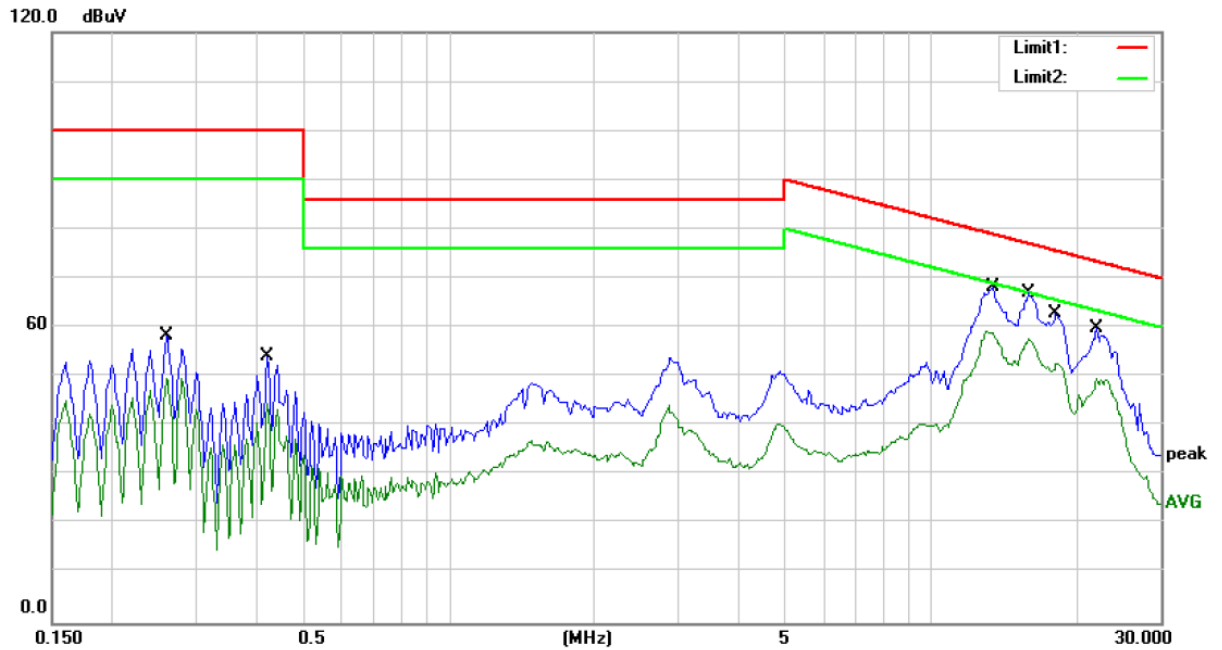

Site Conduction #2 Phase: **N** Temperature: 26
 Limit: (CE)EN62040-2 C3_QP Power: AC 380V/50Hz Humidity: 55 %
 Mode: FULL LOAD
 Note: Line Mode

No. Mk.	Freq. MHz	Reading Level dBuV	Correct Factor dB	Measure- ment dBuV	Limit dBuV	Over dB	Detector	Comment
1	0.2600	58.32	0.00	58.32	100.00	-41.68	QP	
2	0.2600	49.58	0.00	49.58	90.00	-40.42	AVG	
3	0.4200	54.28	0.00	54.28	100.00	-45.72	QP	
4	0.4200	44.68	0.00	44.68	90.00	-45.32	AVG	
5	13.4500	68.28	0.00	68.28	78.95	-10.67	QP	
6	13.4500	59.17	0.00	59.17	68.95	-9.78	AVG	
7	15.9000	66.93	0.00	66.93	77.09	-10.16	QP	
8 *	15.9000	57.63	0.00	57.63	67.09	-9.46	AVG	
9	18.2000	62.70	0.00	62.70	75.58	-12.88	QP	
10	18.2000	52.69	0.00	52.69	65.58	-12.89	AVG	
11	22.1000	59.78	0.00	59.78	73.41	-13.63	QP	
12	22.1000	49.55	0.00	49.55	63.41	-13.86	AVG	

*:Maximum data x:Over limit !:over margin Comment: Factor build in receiver. Operator: DK

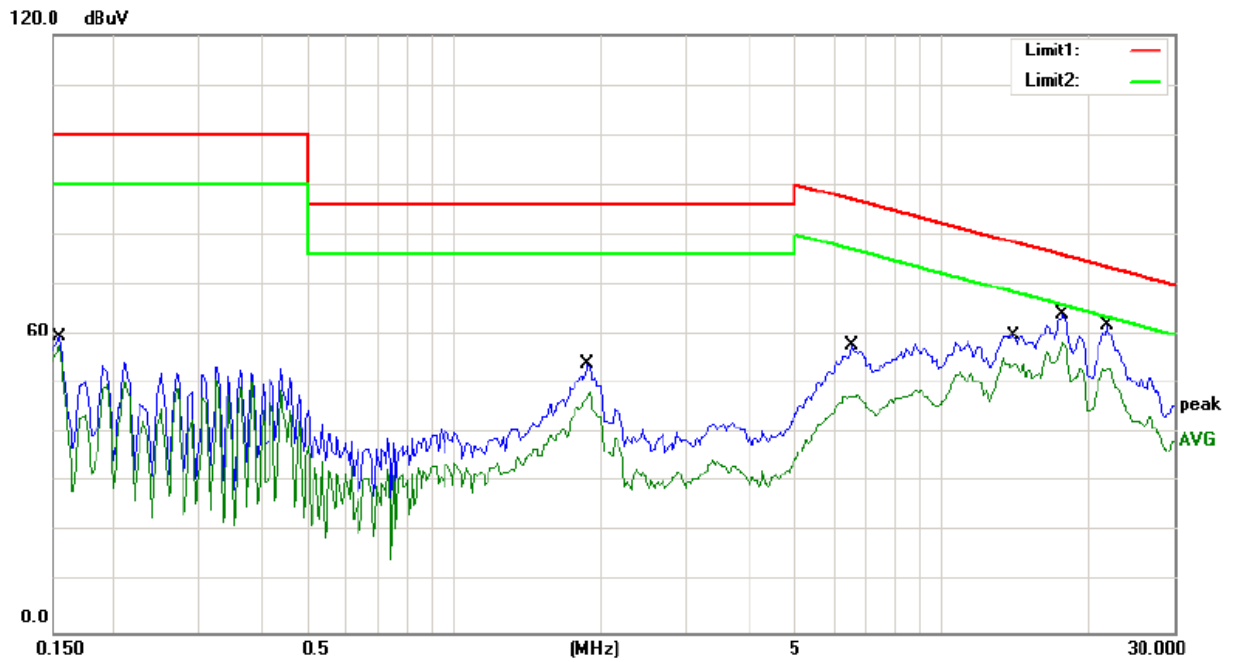

Site Conduction #2

Phase: **L1**

Temperature: 22

Limit: (CE)EN62040-2 C3_QP

Power: AC 380V/50Hz

Humidity: 53 %

Mode: FULL LOAD

Note: BAT MODE

No.	Mk.	Freq. MHz	Reading Level dBuV	Correct Factor dB	Measure- ment dBuV	Limit dBuV	Over dB	Detector	Comment
1		0.1550	59.51	0.00	59.51	100.00	-40.49	QP	
2		0.1550	57.66	0.00	57.66	90.00	-32.34	AVG	
3		1.8800	54.08	0.00	54.08	86.00	-31.92	QP	
4		1.8800	48.41	0.00	48.41	76.00	-27.59	AVG	
5		6.5400	57.78	0.00	57.78	87.00	-29.22	QP	
6		6.5400	47.90	0.00	47.90	77.00	-29.10	AVG	
7		14.0000	59.70	0.00	59.70	78.51	-18.81	QP	
8		14.0000	54.12	0.00	54.12	68.51	-14.39	AVG	
9		17.7750	64.01	0.00	64.01	75.84	-11.83	QP	
10	*	17.7750	58.36	0.00	58.36	65.84	-7.48	AVG	
11		21.8500	61.89	0.00	61.89	73.54	-11.65	QP	
12		21.8500	53.39	0.00	53.39	63.54	-10.15	AVG	

*:Maximum data x:Over limit !:over margin Comment: Factor build in receiver. Operator: HE

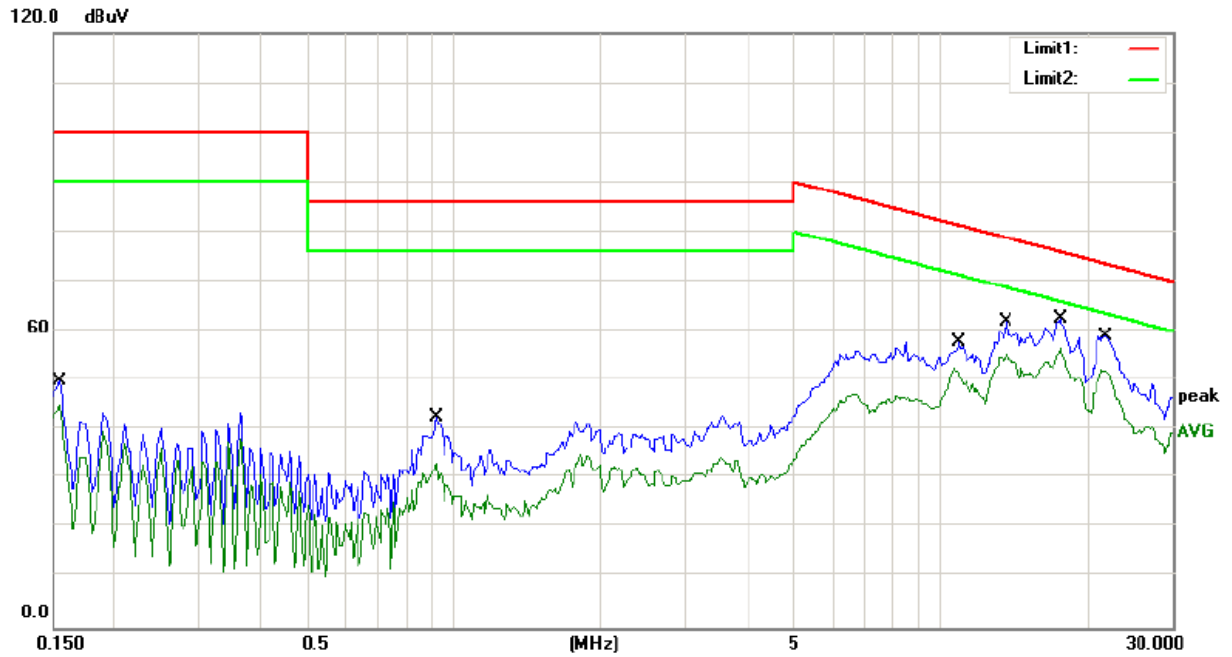

Site Conduction #2 Phase: **L2** Temperature: 22
 Limit: (CE)EN62040-2 C3_QP Power: AC 380V/50Hz Humidity: 53 %
 Mode: FULL LOAD
 Note: BAT MODE

No.	Mk.	Freq.	Reading Level	Correct Factor	Measurement	Limit	Over	Detector	Comment
		MHz	dBuV	dB	dBuV	dBuV	dB		
1		0.1550	50.03	0.00	50.03	100.00	-49.97	QP	
2		0.1550	45.11	0.00	45.11	90.00	-44.89	AVG	
3		0.9200	42.89	0.00	42.89	86.00	-43.11	QP	
4		0.9200	33.24	0.00	33.24	76.00	-42.76	AVG	
5		10.9500	57.71	0.00	57.71	81.25	-23.54	QP	
6		10.9500	52.53	0.00	52.53	71.25	-18.72	AVG	
7		13.6500	62.03	0.00	62.03	78.79	-16.76	QP	
8		13.6500	55.29	0.00	55.29	68.79	-13.50	AVG	
9		17.6750	62.43	0.00	62.43	75.91	-13.48	QP	
10	*	17.6750	56.62	0.00	56.62	65.91	-9.29	AVG	
11		21.9750	58.96	0.00	58.96	73.47	-14.51	QP	
12		21.9750	52.35	0.00	52.35	63.47	-11.12	AVG	

*:Maximum data x:Over limit !:over margin Comment: Factor build in receiver. Operator: HE

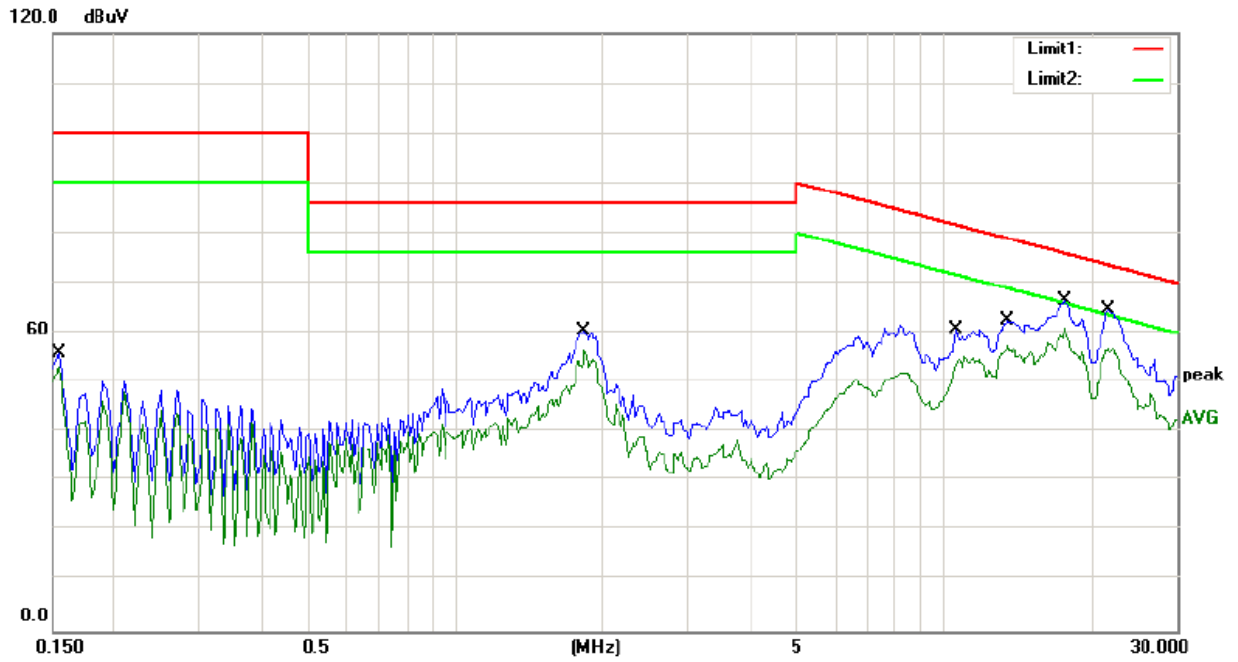

Site Conduction #2 Phase: **L3** Temperature: 22
 Limit: (CE)EN62040-2 C3_QP Power: AC 380V/50Hz Humidity: 53 %
 Mode: FULL LOAD
 Note: BAT MODE

No.	Mk.	Freq. MHz	Reading Level dBuV	Correct Factor dB	Measure- ment dBuV	Limit dBuV	Over dB	Detector	Comment
1		0.1550	55.95	0.00	55.95	100.00	-44.05	QP	
2		0.1550	53.27	0.00	53.27	90.00	-36.73	AVG	
3		1.8450	60.39	0.00	60.39	86.00	-25.61	QP	
4		1.8450	56.51	0.00	56.51	76.00	-19.49	AVG	
5		10.5750	60.62	0.00	60.62	81.64	-21.02	QP	
6		10.5750	55.29	0.00	55.29	71.64	-16.35	AVG	
7		13.5000	62.52	0.00	62.52	78.91	-16.39	QP	
8		13.5000	57.40	0.00	57.40	68.91	-11.51	AVG	
9		17.7000	66.59	0.00	66.59	75.89	-9.30	QP	
10	*	17.7000	61.17	0.00	61.17	65.89	-4.72	AVG	
11		21.7250	64.72	0.00	64.72	73.60	-8.88	QP	
12		21.7250	56.81	0.00	56.81	63.60	-6.79	AVG	

*:Maximum data x:Over limit !:over margin Comment: Factor build in receiver. Operator: HE

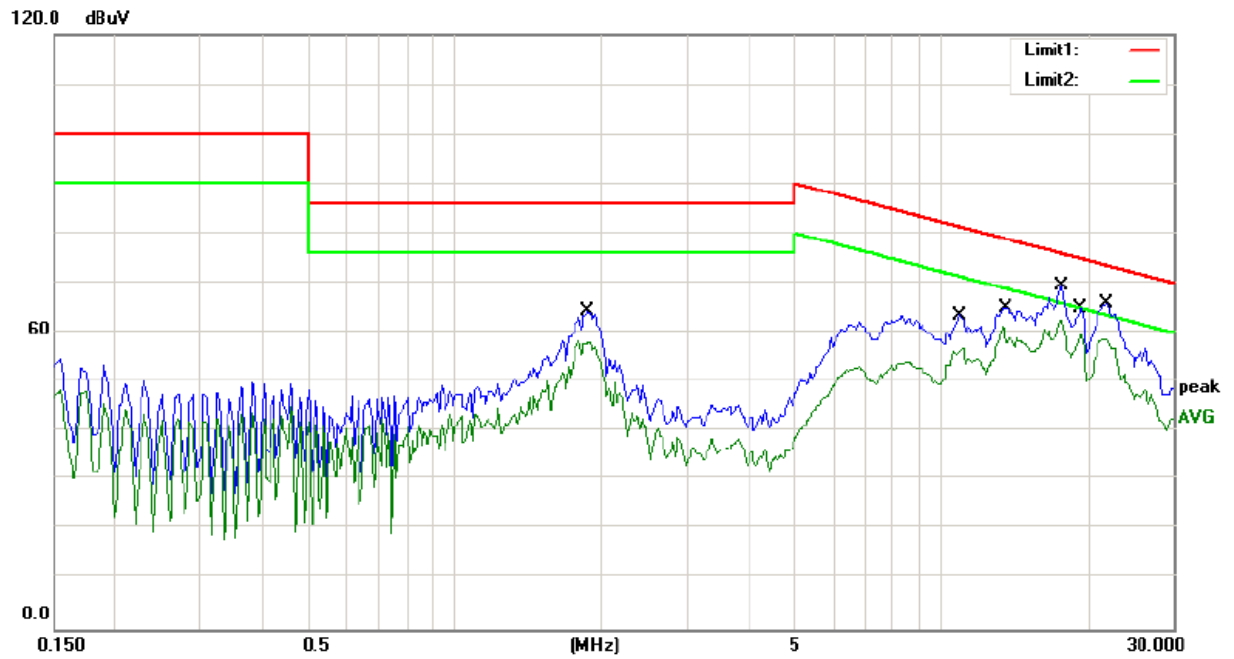

Site Conduction #2 Phase: **N** Temperature: 22
 Limit: (CE)EN62040-2 C3_QP Power: AC 380V/50Hz Humidity: 53 %
 Mode: FULL LOAD
 Note: BAT MODE

No.	Mk.	Freq.	Reading Level	Correct Factor	Measurement	Limit	Over	Detector	Comment
		MHz	dBuV	dB	dBuV	dBuV	dB		
1		1.8800	64.25	0.00	64.25	86.00	-21.75	QP	
2		1.8800	58.42	0.00	58.42	76.00	-17.58	AVG	
3		10.8500	63.60	0.00	63.60	81.35	-17.75	QP	
4		10.8500	56.88	0.00	56.88	71.35	-14.47	AVG	
5		13.6000	64.97	0.00	64.97	78.83	-13.86	QP	
6		13.6000	61.21	0.00	61.21	68.83	-7.62	AVG	
7		17.7750	69.48	0.00	69.48	75.84	-6.36	QP	
8	*	17.7750	62.41	0.00	62.41	65.84	-3.43	AVG	
9		19.4250	64.91	0.00	64.91	74.85	-9.94	QP	
10		19.4250	59.64	0.00	59.64	64.85	-5.21	AVG	
11		22.0000	65.86	0.00	65.86	73.46	-7.60	QP	
12		22.0000	58.74	0.00	58.74	63.46	-4.72	AVG	

*:Maximum data x:Over limit !:over margin Comment: Factor build in receiver. Operator: HE

5. RADIATED EMISSION MEASUREMENT

5.1. Block Diagram of Test

5.1.1. Block diagram of connection between the EUT and simulators



(EUT: Uninterruptible Power Supply)

5.1.2. Block diagram of test setup (In chamber)

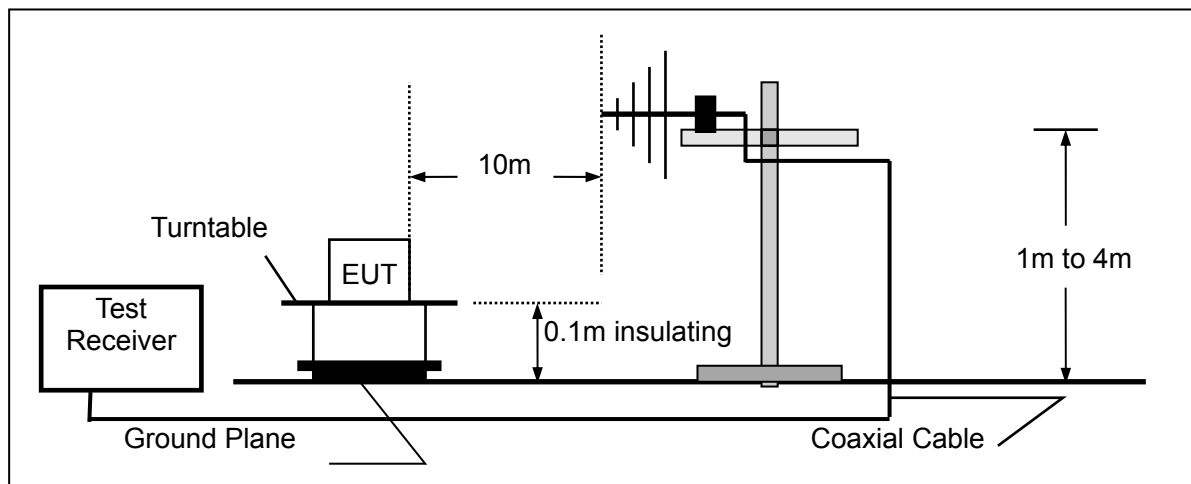

(EUT: Uninterruptible Power Supply)

5.2. Measuring Standard

EN62040-2: 2006 Category C3

5.3. Radiated Emission Limits(C3)

All emanations from a C3 device or system, including any network of conductors and apparatus connected thereto, shall not exceed the level of field strengths specified below:

FREQUENCY (MHz)	DISTANCE (Meters)	FIELD STRENGTHS LIMIT (dB μ V/m)
30 ~ 230	10	50
230 ~ 1000	10	57

Note: (1) The smaller limit shall apply at the combination point between two frequency bands.
(2) Distance refers to the distance in meters between the measuring instrument antenna and the closed point of any part of the EUT.

5.4. EUT Configuration on Test

The EN 62040-2 regulations test method must be used to find the maximum emission during radiated emission measurement.

5.5. Operating Condition of EUT

5.5.1. Turn on the power.

5.5.2. After that, let the EUT work in test mode (Line mode) and measure it.

5.6. Test Procedure

The EUT is placed on a turn table which is 0.1 meter high above the ground. The turn table can rotate 360 degrees to determine the position of the maximum emission level. The EUT is set 10 meters away from the receiving antenna which is mounted on an antenna tower. The antenna can be moved up and down from 1 to 4 meters to find out the maximum emission level. Bilog antenna (calibrated by Dipole Antenna) is used as a receiving antenna. Both horizontal and vertical polarization of the antenna are set on test.

The bandwidth of the Receiver is set at 120kHz.

5.7. Measuring Results

PASS.

The frequency range from 30MHz to 1000MHz is investigated.

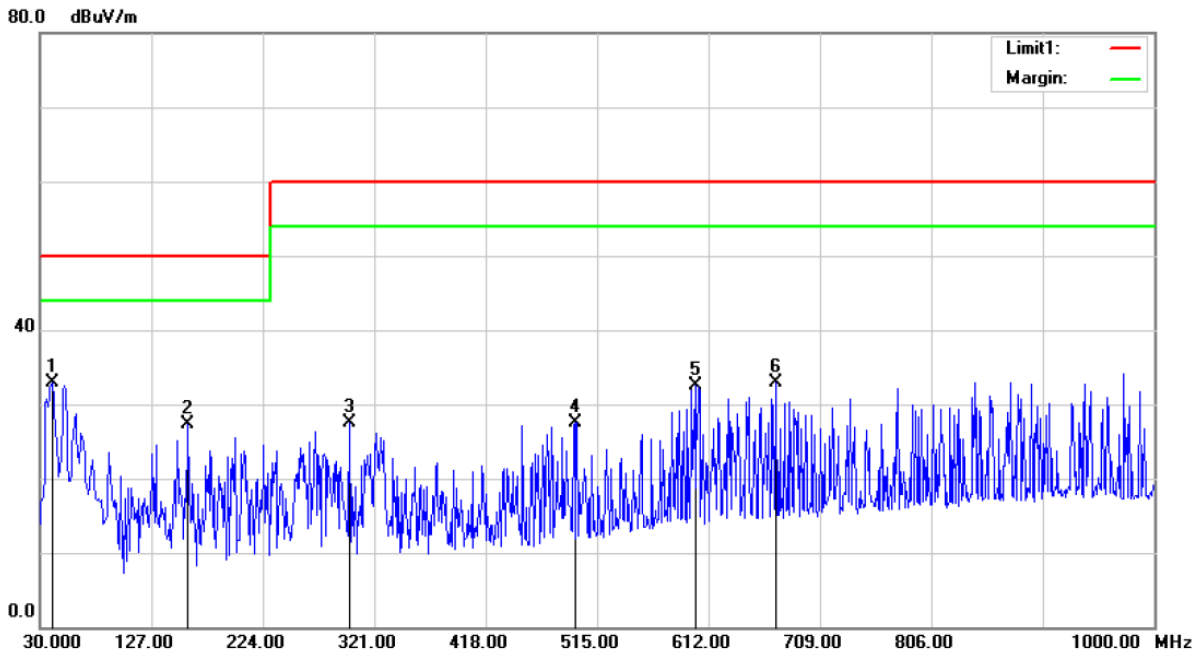

Site :10m Chamber #1 Polarization: *Horizontal* Temperature: 26
 Limit: (RE 10M)EN62040-2 C3 Power: AC380V/50Hz Humidity: 60 %
 Mode:FULL LOAD
 Note: LINE MODE

No.	Mk.	Freq.	Reading Level	Correct Factor	Measurement	Limit	Over	Antenna Height	Table Degree	Comment
		MHz	dBuV	dB	dBuV/m	dBuV/m	dB	cm	degree	
1	*	40.6700	64.20	-31.25	32.95	50.00	-17.05	QP 178	0	
2		159.0100	62.60	-35.22	27.38	50.00	-22.62	QP 178	0	
3		299.6600	57.07	-29.52	27.55	60.00	-32.45	QP 178	0	
4		495.6000	52.99	-25.54	27.45	60.00	-32.55	QP 178	0	
5		601.3300	55.90	-23.34	32.56	60.00	-27.44	QP 178	0	
6		670.2000	55.31	-22.50	32.81	60.00	-27.19	QP 178	0	

*:Maximum data x:Over limit !:over margin

Operator: CSL

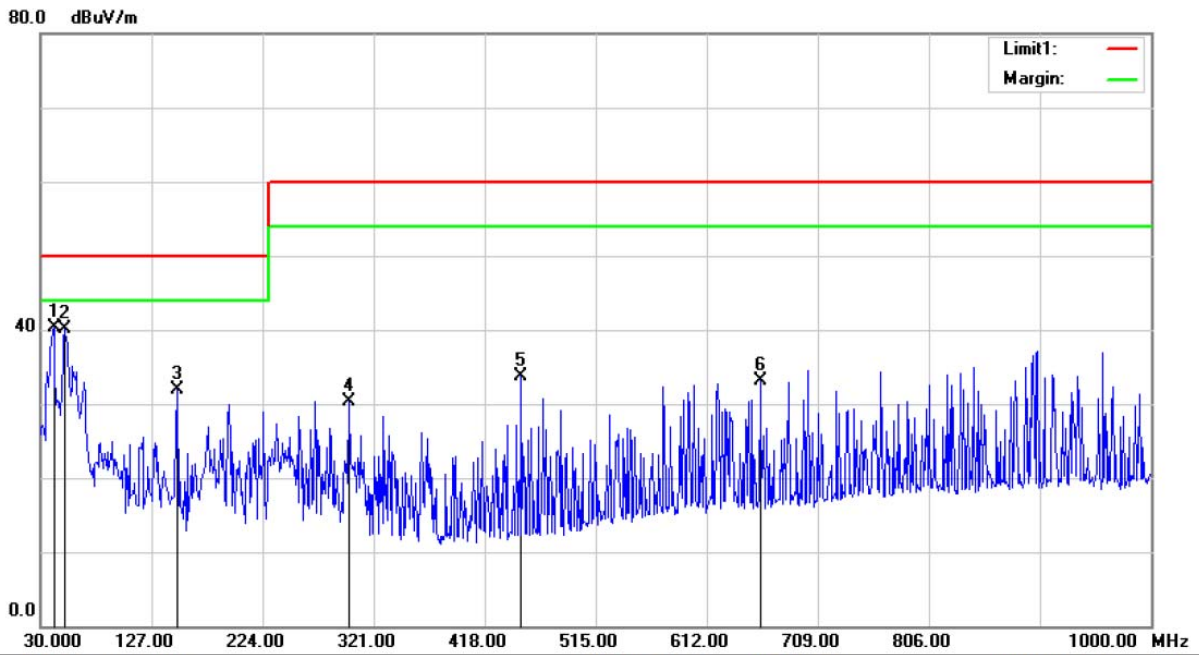

Site :10m Chamber #1 Polarization: **Vertical** Temperature: 26
 Limit: (RE 10M)EN62040-2 C3 Power: AC380V/50Hz Humidity: 60 %
 Mode:FULL LOAD
 Note: LINE MODE

No.	Mk.	Freq.	Reading Level	Correct Factor	Measurement	Limit	Over	Antenna Height	Table Degree	
		MHz	dBuV	dB	dBuV/m	dBuV/m	dB	Detector	cm	degree
1	*	41.6400	71.02	-30.63	40.39	50.00	-9.61	QP	100	0
2		51.3400	69.85	-29.84	40.01	50.00	-9.99	QP	100	0
3		149.3100	66.58	-34.74	31.84	50.00	-18.16	QP	100	0
4		299.6600	58.67	-28.31	30.36	60.00	-29.64	QP	100	0
5		450.0100	58.59	-24.80	33.79	60.00	-26.21	QP	100	0
6		658.5600	53.86	-20.82	33.04	60.00	-26.96	QP	100	0

*:Maximum data x:Over limit !:over margin

Operator: CSL

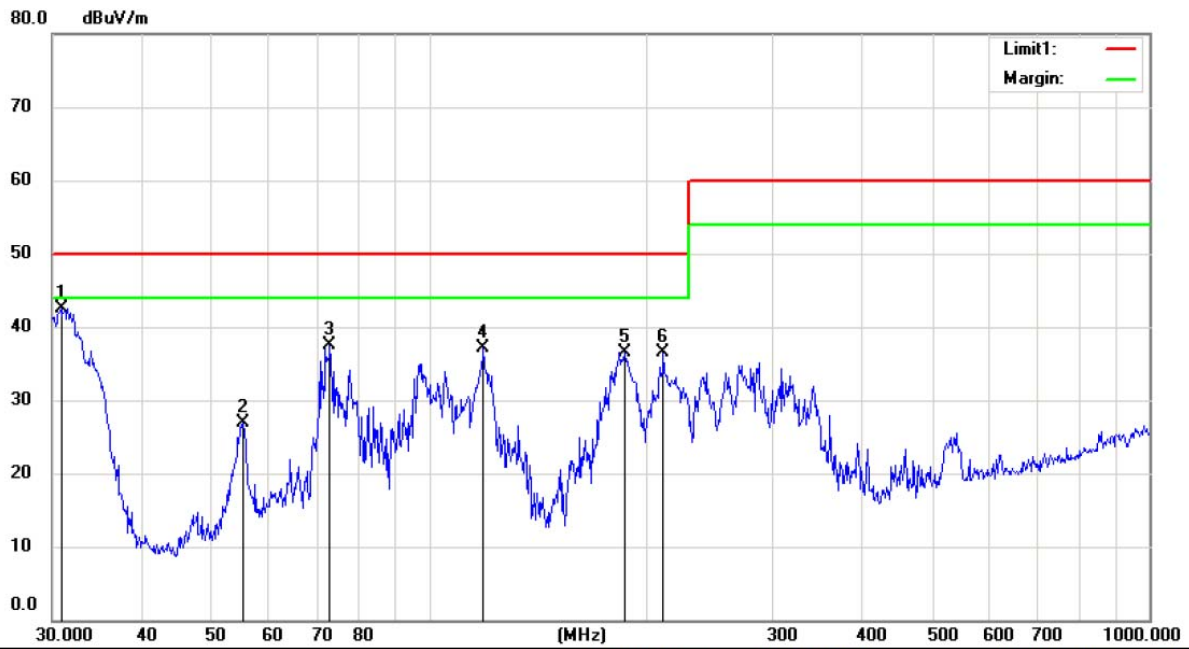

Site site #1 Polarization: **Horizontal** Temperature: 24 C
 Limit: EN62040-2 C3 10M Power: AC 380V/50Hz Humidity: 53 %
 Mode: Full LOAD
 Note: BAT MODE

No.	Mk.	Freq.	Reading Level	Correct Factor	Measurement	Limit	Over	Antenna Height	Table Degree	
		MHz	dBuV	dB	dBuV/m	dBuV/m	dB	cm	degree	Comment
1	*	30.8535	63.76	-21.29	42.47	50.00	-7.53	QP		
2		55.2207	47.23	-20.30	26.93	50.00	-23.07	QP		
3		72.8466	62.51	-24.98	37.53	50.00	-12.47	QP		
4		119.0180	59.18	-22.08	37.10	50.00	-12.90	QP		
5		187.0958	57.99	-21.45	36.54	50.00	-13.46	QP		
6		211.5265	57.03	-20.46	36.57	50.00	-13.43	QP		

*:Maximum data x:Over limit !:over margin

Operator: CYS

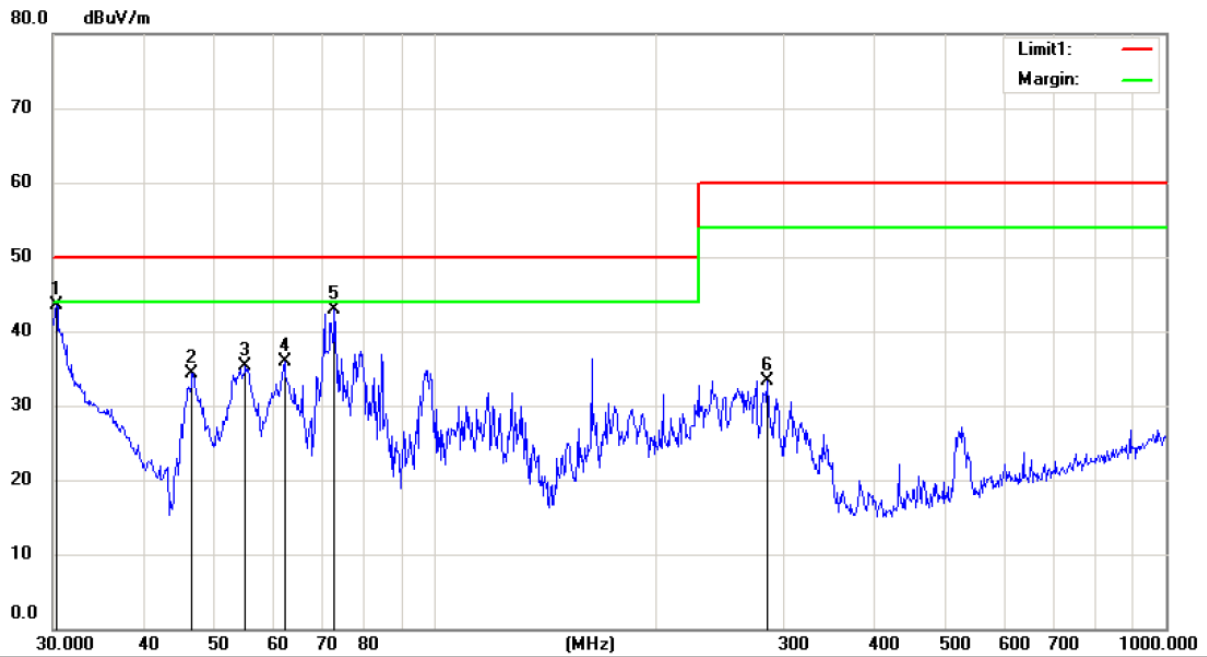

Site site #1 Polarization: **Vertical** Temperature: 24 C
 Limit: EN62040-2 C3 10M Power: AC 380V/50Hz Humidity: 53 %
 Mode: Full LOAD
 Note: BAT MODE

No.	Mk.	Freq.	Reading	Correct	Measure-	Limit	Over	Antenna	Table	
		MHz	Level	Factor	ment			Height	Degree	Comment
			dBuV	dB	dBuV/m	dBuV/m	dB	cm	degree	
1	*	30.3173	64.71	-21.30	43.41	50.00	-6.59			QP
2		46.5030	54.35	-19.95	34.40	50.00	-15.60			QP
3		55.0274	55.66	-20.30	35.36	50.00	-14.64			QP
4		62.2128	57.39	-21.42	35.97	50.00	-14.03			QP
5		72.8466	67.91	-24.97	42.94	50.00	-7.06			QP
6		284.9767	51.03	-17.66	33.37	60.00	-26.63			QP

*:Maximum data x:Over limit !:over margin

Operator: CYS

6. HARMONIC CURRENT EMISSION MEASUREMENT

6.1. Block Diagram of Test Setup

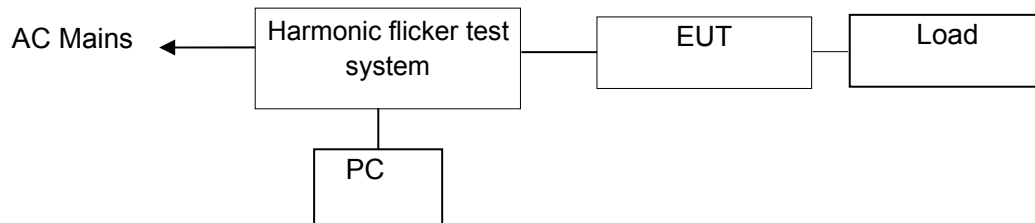

(EUT: Uninterruptible Power Supply)

6.2. Measuring Standard

EN 61000-3-12: 2011 CLASS A

6.3. Operation Condition of EUT

Same as Section 4.4, except the test setup replaced as Section 6.1.

6.4. Measuring Results

PASS.

Please see the attached pages.

Harmonics – Per EN/IEC61000-3-12(Phase A-Run time)

EUT: UNINTERRUPTIBLE POWER SYSTEM(HT33030XL) Tested by: Test Operator
 Test category: Table:2, R_{sce}≥350, Inter-Harm, Test Margin: 100
 Test date: 2015/1/21 Start time: 13:49:47 End time: 13:52:39
 Test duration (min): 2.5 Data file name: WIN2106_H-000074.cts_data
 Comment: Full Load
 Customer: YWT

Test Result: Pass Source qualification: Distorted

Current & voltage waveforms

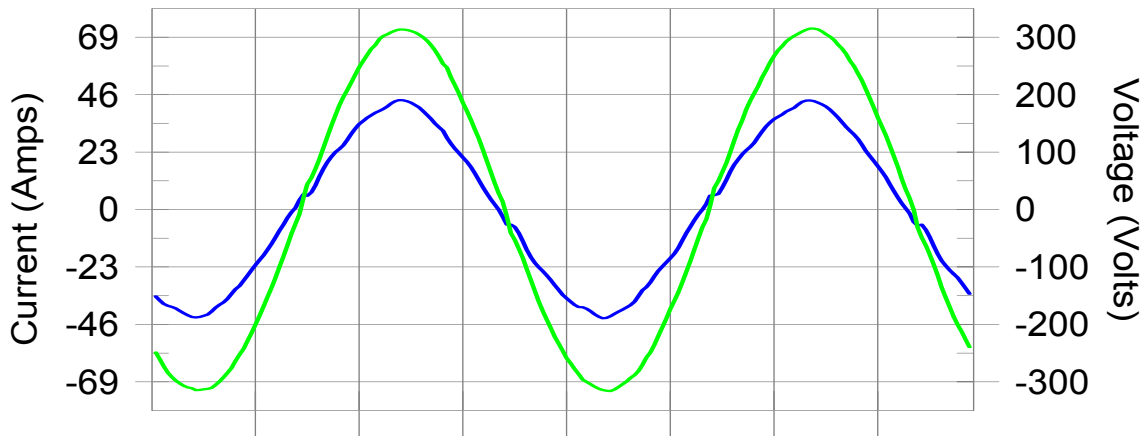

Harmonics and Class 2 limit line

European Limits

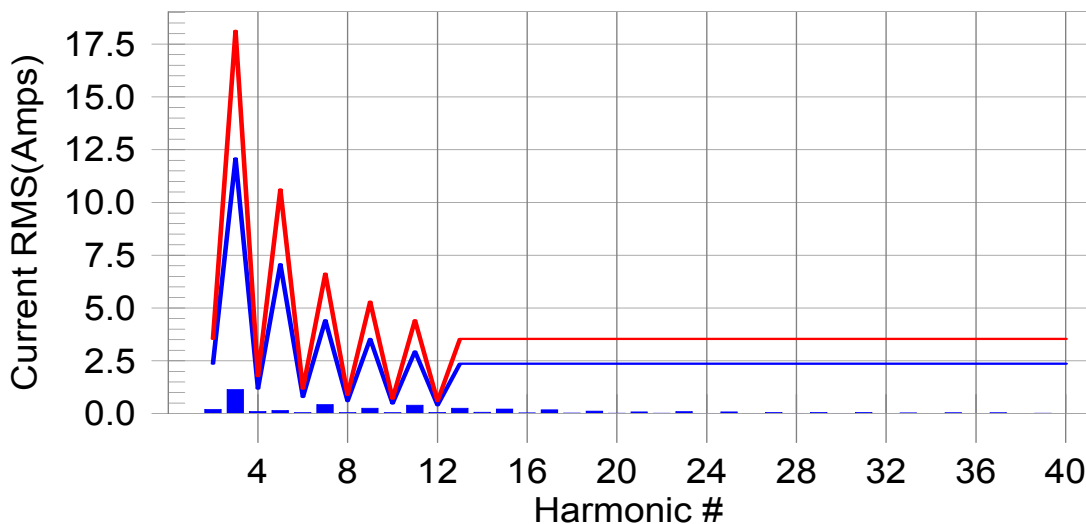

Test result: Pass Worst harmonic was #12 with 23.18 % of the limit.

Current Test Result Summary (Phase A-Run time)

EUT: UNINTERRUPTIBLE POWER SYSTEM(HT33030XL) Tested by: Test Operator
 Test category: Table:2, R_{sce}≥350, Inter-Harm, Test Margin: 100
 Test date: 2015/1/21 Start time: 13:49:47 End time: 13:52:39
 Test duration (min): 2.5 Data file name: WIN2106_H-000074.cts_data
 Comment: Full Load
 Customer: YWT

Test Result: Pass Measured I-ref: 29.490 Amp rms Source: Distorted
 I-THC(%): 4.809 Limit(%): 47.000 PWHC(%): 5.576 PWHC Limit(%): 47.000

Highest parameter values during test:

V_{RMS} (Volts): 222.84 Frequency(Hz): 50.00
 I_{Peak} (Amps): 44.921 I_{RMS} (Amps): 29.776
 I_{Fund} (Amps): 29.666 Crest Factor: 1.527
 Power (Watts): 6604 Power Factor: 0.996

Harm#	Harms(avg)	100%Limit	%of Limit	Harms(max)	150%Limit	%of Limit	Status
2	0.203	2.359	8.6	0.220	3.539	6.2	Pass
3	1.145	12.091	9.5	1.174	18.137	6.5	Pass
4	0.100	1.180	8.5	0.125	1.769	7.1	Pass
5	0.150	7.078	2.1	0.179	10.616	1.7	Pass
6	0.052	0.786	6.6	0.103	1.180	8.7	Pass
7	0.427	4.424	9.7	0.453	6.635	6.8	Pass
8	0.052	0.590	8.9	0.129	0.885	14.6	Pass
9	0.252	3.539	7.1	0.286	5.308	5.4	Pass
10	0.050	0.472	10.6	0.121	0.708	17.1	Pass
11	0.401	2.949	13.6	0.436	4.424	9.9	Pass
12	0.060	0.393	15.4	0.137	0.590	23.2	Pass
13	0.256	2.359	10.9	0.307	3.539	8.7	Pass
14	0.061	N/A	N/A	0.115	N/A	N/A	N/A
15	0.222	N/A	N/A	0.249	N/A	N/A	N/A
16	0.038	N/A	N/A	0.098	N/A	N/A	N/A
17	0.177	N/A	N/A	0.198	N/A	N/A	N/A
18	0.031	N/A	N/A	0.070	N/A	N/A	N/A
19	0.120	N/A	N/A	0.139	N/A	N/A	N/A
20	0.026	N/A	N/A	0.051	N/A	N/A	N/A
21	0.077	N/A	N/A	0.087	N/A	N/A	N/A
22	0.019	N/A	N/A	0.045	N/A	N/A	N/A
23	0.097	N/A	N/A	0.125	N/A	N/A	N/A
24	0.015	N/A	N/A	0.033	N/A	N/A	N/A
25	0.086	N/A	N/A	0.094	N/A	N/A	N/A
26	0.014	N/A	N/A	0.030	N/A	N/A	N/A
27	0.058	N/A	N/A	0.065	N/A	N/A	N/A
28	0.011	N/A	N/A	0.026	N/A	N/A	N/A
29	0.059	N/A	N/A	0.079	N/A	N/A	N/A
30	0.011	N/A	N/A	0.018	N/A	N/A	N/A
31	0.057	N/A	N/A	0.060	N/A	N/A	N/A
32	0.008	N/A	N/A	0.016	N/A	N/A	N/A
33	0.034	N/A	N/A	0.039	N/A	N/A	N/A
34	0.007	N/A	N/A	0.017	N/A	N/A	N/A
35	0.046	N/A	N/A	0.061	N/A	N/A	N/A
36	0.006	N/A	N/A	0.015	N/A	N/A	N/A
37	0.043	N/A	N/A	0.046	N/A	N/A	N/A
38	0.006	N/A	N/A	0.012	N/A	N/A	N/A
39	0.023	N/A	N/A	0.027	N/A	N/A	N/A
40	0.005	N/A	N/A	0.011	N/A	N/A	N/A

Note: Measured I-ref was applied for this test.

Voltage Source Verification Data (Phase A-Run time)

EUT: UNINTERRUPTIBLE POWER SYSTEM(HT33030XL) Tested by: Test Operator
 Test category: Table:2, R_{sce}≥350, Inter-Harm, Test Margin: 100
 Test date: 2015/1/21 Start time: 13:49:47 End time: 13:52:39
 Test duration (min): 2.5 Data file name: WIN2106_H-000074.cts_data
 Comment: Full Load
 Customer: YWT

Test Result: Pass Source qualification: Distorted
 Current harmonics are corrected for source distortion, and are within +/-5%
 Measurements are compliant with IEC/EN61000-3-12 Ed.2 (2011) & IEC/EN61000-4-7

Highest parameter values during test:

Voltage (Vrms):	222.84	Frequency(Hz):	50.00
I_Peak (Amps):	44.921	I_RMS (Amps):	29.776
I_Fund (Amps):	29.666	Crest Factor:	1.527
Power (Watts):	6604	Power Factor:	0.996

Harm#	Harmonics V-rms	Limit V-rms	% of Limit	Status
2	0.280	0.891	31.36	OK
3	0.471	2.784	16.93	OK
4	0.108	0.891	12.14	OK
5	0.227	3.341	6.79	OK
6	0.095	0.891	10.65	OK
7	0.620	2.785	22.26	OK
8	0.206	0.891	23.09	OK
9	0.707	1.336	52.92	OK
10	0.199	0.891	22.33	OK
11	1.081	1.560	69.31	OK
12	0.209	0.668	31.30	OK
13	1.107	1.336	82.87	OK
14	0.240	0.668	35.96	OK
15	0.989	0.668	147.95	Dist.
16	0.233	0.668	34.82	OK
17	0.909	0.668	136.07	Dist.
18	0.203	0.668	30.42	OK
19	0.731	0.668	109.41	Marg.
20	0.167	0.668	25.03	OK
21	0.514	0.668	76.85	OK
22	0.110	0.668	16.39	OK
23	0.725	0.668	108.46	Marg.
24	0.103	0.668	15.36	OK
25	0.557	0.668	83.29	OK
26	0.103	0.668	15.47	OK
27	0.378	0.668	56.59	OK
28	0.079	0.668	11.76	OK
29	0.472	0.668	70.67	OK
30	0.080	0.668	11.92	OK
31	0.361	0.668	54.07	OK
32	0.062	0.668	9.22	OK
33	0.295	0.668	44.14	OK
34	0.071	0.668	10.56	OK
35	0.345	0.668	51.57	OK
36	0.058	0.668	8.64	OK
37	0.308	0.668	46.12	OK
38	0.050	0.668	7.41	OK
39	0.187	0.668	28.03	OK
40	0.076	0.668	11.32	OK

Harmonics – Per EN/IEC61000-3-12(Phase B-Run time)

EUT: UNINTERRUPTIBLE POWER SYSTEM(HT33030XL) Tested by: Test Operator
 Test category: Table:2, R_{sce}≥350, Inter-Harm, Test Margin: 100
 Test date: 2015/1/21 Start time: 13:49:47 End time: 13:52:39
 Test duration (min): 2.5 Data file name: WIN2106_H-000074.cts_data
 Comment: Full Load
 Customer: YWT

Test Result: Pass Source qualification: Distorted

Current & voltage waveforms

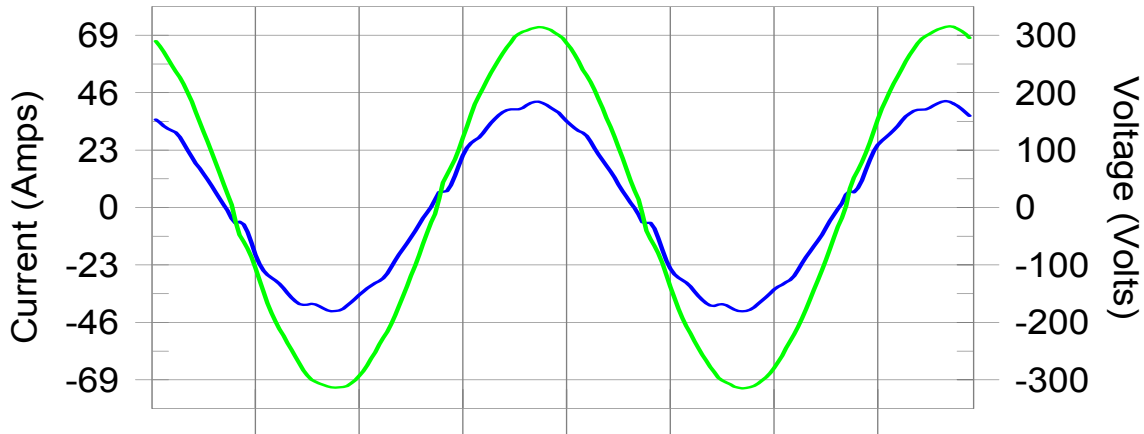

Harmonics and Class 2 limit line

European Limits

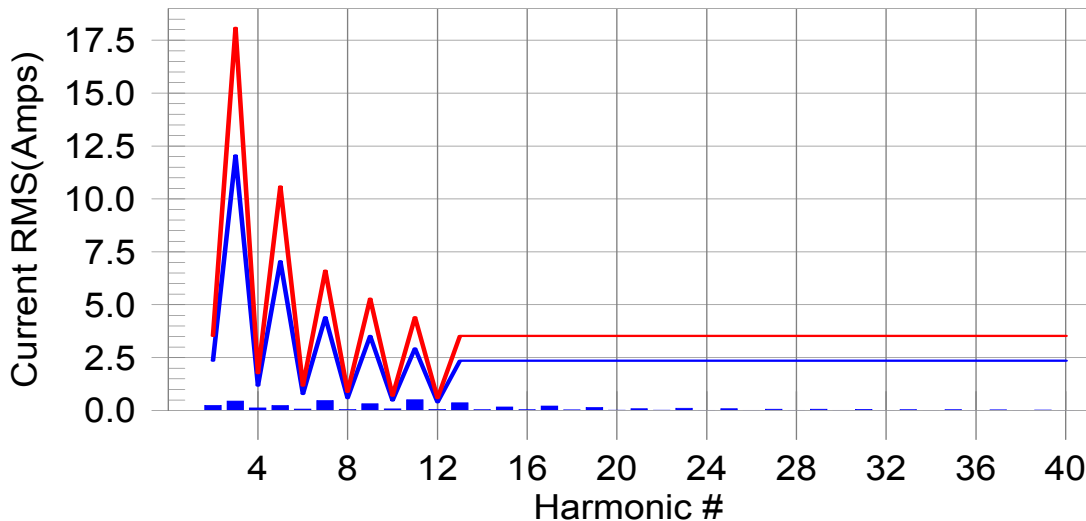

Test result: Pass Worst harmonic was #10 with 22.53 % of the limit.

Current Test Result Summary (Phase B-Run time)

EUT: UNINTERRUPTIBLE POWER SYSTEM(HT33030XL) Tested by: Test Operator
 Test category: Table:2, R_{sce}≥350, Inter-Harm, Test Margin: 100
 Test date: 2015/1/21 Start time: 13:49:47 End time: 13:52:39
 Test duration (min): 2.5 Data file name: WIN2106_H-000074.cts_data
 Comment: Full Load
 Customer: YWT

Test Result: Pass Measured I-ref: 29.490 Amp rms Source: Distorted
 I-THC(%): 3.795 Limit(%): 47.000 PWHC(%): 5.919 PWHC Limit(%): 47.000

Highest parameter values during test:

V_{RMS} (Volts): 222.70 Frequency(Hz): 50.00
 I_{Peak} (Amps): 43.344 I_{RMS} (Amps): 29.642
 I_{Fund} (Amps): 29.558 Crest Factor: 1.476
 Power (Watts): 6562 Power Factor: 0.995

Harm#	Harms(avg)	100%Limit	%of Limit	Harms(max)	150%Limit	%of Limit	Status
2	0.250	2.353	10.6	0.269	3.530	7.6	Pass
3	0.452	12.061	3.7	0.479	18.091	2.6	Pass
4	0.128	1.177	10.9	0.154	1.765	8.7	Pass
5	0.238	7.060	3.4	0.348	10.590	3.3	Pass
6	0.074	0.784	9.5	0.124	1.177	10.5	Pass
7	0.479	4.413	10.8	0.625	6.619	9.4	Pass
8	0.054	0.588	9.1	0.126	0.883	14.3	Pass
9	0.323	3.530	9.2	0.356	5.295	6.7	Pass
10	0.086	0.471	18.4	0.159	0.706	22.5	Pass
11	0.516	2.942	17.5	0.626	4.413	14.2	Pass
12	0.058	0.392	14.9	0.124	0.588	21.0	Pass
13	0.365	2.353	15.5	0.455	3.530	12.9	Pass
14	0.047	N/A	N/A	0.105	N/A	N/A	N/A
15	0.172	N/A	N/A	0.207	N/A	N/A	N/A
16	0.045	N/A	N/A	0.087	N/A	N/A	N/A
17	0.218	N/A	N/A	0.261	N/A	N/A	N/A
18	0.035	N/A	N/A	0.063	N/A	N/A	N/A
19	0.149	N/A	N/A	0.165	N/A	N/A	N/A
20	0.023	N/A	N/A	0.050	N/A	N/A	N/A
21	0.091	N/A	N/A	0.103	N/A	N/A	N/A
22	0.021	N/A	N/A	0.041	N/A	N/A	N/A
23	0.110	N/A	N/A	0.116	N/A	N/A	N/A
24	0.013	N/A	N/A	0.031	N/A	N/A	N/A
25	0.090	N/A	N/A	0.096	N/A	N/A	N/A
26	0.013	N/A	N/A	0.029	N/A	N/A	N/A
27	0.067	N/A	N/A	0.074	N/A	N/A	N/A
28	0.011	N/A	N/A	0.024	N/A	N/A	N/A
29	0.067	N/A	N/A	0.071	N/A	N/A	N/A
30	0.012	N/A	N/A	0.018	N/A	N/A	N/A
31	0.058	N/A	N/A	0.061	N/A	N/A	N/A
32	0.010	N/A	N/A	0.017	N/A	N/A	N/A
33	0.041	N/A	N/A	0.045	N/A	N/A	N/A
34	0.009	N/A	N/A	0.017	N/A	N/A	N/A
35	0.046	N/A	N/A	0.050	N/A	N/A	N/A
36	0.007	N/A	N/A	0.015	N/A	N/A	N/A
37	0.037	N/A	N/A	0.040	N/A	N/A	N/A
38	0.007	N/A	N/A	0.012	N/A	N/A	N/A
39	0.031	N/A	N/A	0.034	N/A	N/A	N/A
40	0.005	N/A	N/A	0.010	N/A	N/A	N/A

Note: Measured I-ref was applied for this test.

Voltage Source Verification Data (Phase B-Run time)

EUT: UNINTERRUPTIBLE POWER SYSTEM(HT33030XL) Tested by: Test Operator
 Test category: Table:2, R_{sce}≥350, Inter-Harm, Test Margin: 100
 Test date: 2015/1/21 Start time: 13:49:47 End time: 13:52:39
 Test duration (min): 2.5 Data file name: WIN2106_H-000074.cts_data
 Comment: Full Load
 Customer: YWT

Test Result: Pass Source qualification: Distorted
 Current harmonics are corrected for source distortion, and are within +/-5%
 Measurements are compliant with IEC/EN61000-3-12 Ed.2 (2011) & IEC/EN61000-4-7

Highest parameter values during test:

Voltage (Vrms):	222.70	Frequency(Hz):	50.00
I_Peak (Amps):	43.344	I_RMS (Amps):	29.642
I_Fund (Amps):	29.558	Crest Factor:	1.476
Power (Watts):	6562	Power Factor:	0.995

Harm#	Harmonics V-rms	Limit V-rms	% of Limit	Status
2	0.310	0.890	34.78	OK
3	0.418	2.783	15.02	OK
4	0.125	0.890	14.06	OK
5	0.268	3.340	8.02	OK
6	0.124	0.890	13.98	OK
7	0.793	2.783	28.49	OK
8	0.153	0.891	17.18	OK
9	0.657	1.335	49.22	OK
10	0.317	0.891	35.64	OK
11	1.387	1.558	89.02	OK
12	0.236	0.668	35.37	OK
13	1.318	1.336	98.64	OK
14	0.245	0.668	36.66	OK
15	0.962	0.668	144.08	Dist.
16	0.248	0.668	37.20	OK
17	1.001	0.668	149.89	Dist.
18	0.181	0.668	27.18	OK
19	0.777	0.668	116.36	Dist.
20	0.154	0.668	22.99	OK
21	0.592	0.668	88.65	OK
22	0.135	0.668	20.15	OK
23	0.628	0.668	94.02	OK
24	0.116	0.668	17.43	OK
25	0.547	0.668	81.86	OK
26	0.122	0.668	18.24	OK
27	0.461	0.668	68.95	OK
28	0.099	0.668	14.81	OK
29	0.487	0.668	72.94	OK
30	0.096	0.668	14.35	OK
31	0.429	0.668	64.20	OK
32	0.092	0.668	13.78	OK
33	0.301	0.668	45.09	OK
34	0.081	0.668	12.11	OK
35	0.374	0.668	56.05	OK
36	0.049	0.668	7.29	OK
37	0.301	0.668	45.03	OK
38	0.067	0.668	10.01	OK
39	0.226	0.668	33.91	OK
40	0.064	0.668	9.59	OK

Harmonics – Per EN/IEC61000-3-12(Phase C-Run time)

EUT: UNINTERRUPTIBLE POWER SYSTEM(HT33030XL) Tested by: Test Operator
 Test category: Table:2, R_{sce}≥350, Inter-Harm, Test Margin: 100
 Test date: 2015/1/21 Start time: 13:49:47 End time: 13:52:39
 Test duration (min): 2.5 Data file name: WIN2106_H-000074.cts_data
 Comment: Full Load
 Customer: YWT

Test Result: Pass Source qualification: Distorted

Current & voltage waveforms

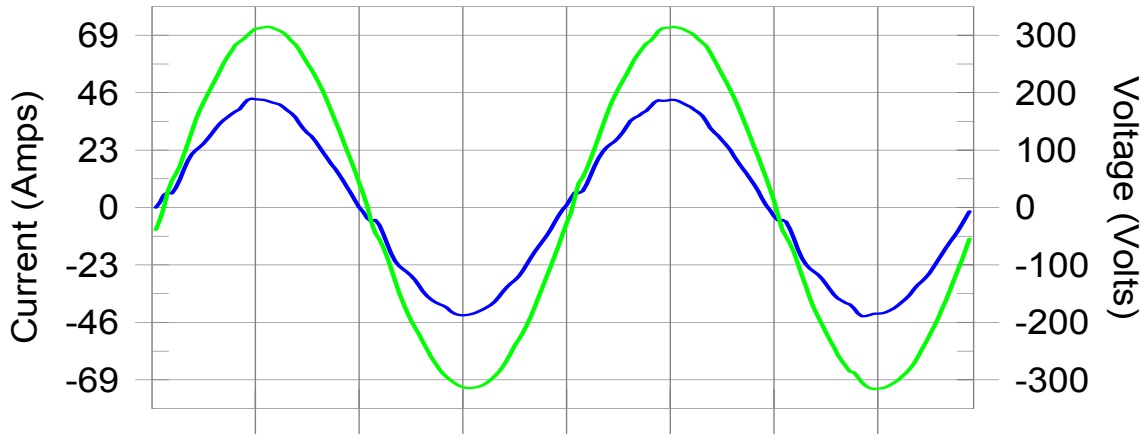

Harmonics and Class 2 limit line

European Limits

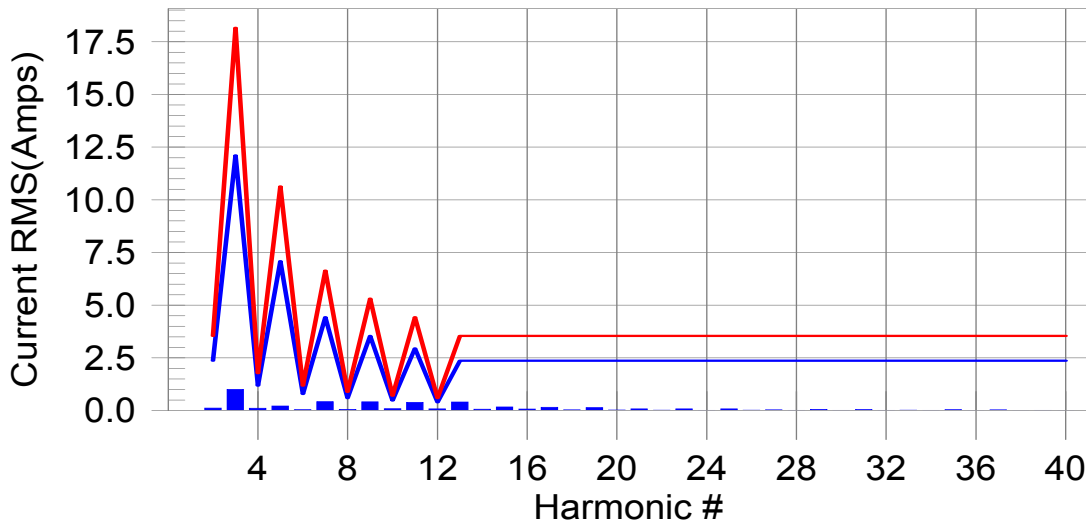

Test result: Pass Worst harmonic was #12 with 25.59 % of the limit.

Current Test Result Summary (Phase C-Run time)

EUT: UNINTERRUPTIBLE POWER SYSTEM(HT33030XL) Tested by: Test Operator
 Test category: Table:2, R_{sce}≥350, Inter-Harm, Test Margin: 100
 Test date: 2015/1/21 Start time: 13:49:47 End time: 13:52:39
 Test duration (min): 2.5 Data file name: WIN2106_H-000074.cts_data
 Comment: Full Load
 Customer: YWT

Test Result: Pass Measured I-ref: 29.490 Amp rms Source: Distorted
 I-THC(%): 4.679 Limit(%): 47.000 PWHC(%): 5.189 PWHC Limit(%): 47.000

Highest parameter values during test:

V_{RMS} (Volts): 222.80 Frequency(Hz): 50.00
 I_{Peak} (Amps): 44.990 I_{RMS} (Amps): 29.780
 I_{Fund} (Amps): 29.729 Crest Factor: 1.526
 Power (Watts): 6597 Power Factor: 0.995

Harm#	Harms(avg)	100%Limit	%of Limit	Harms(max)	150%Limit	%of Limit	Status
2	0.119	2.363	5.0	0.138	3.545	3.9	Pass
3	1.009	12.112	8.3	1.043	18.168	5.7	Pass
4	0.112	1.182	9.4	0.138	1.772	7.8	Pass
5	0.216	7.090	3.0	0.251	10.635	2.4	Pass
6	0.043	0.788	5.5	0.094	1.182	8.0	Pass
7	0.425	4.431	9.6	0.458	6.647	6.9	Pass
8	0.055	0.591	9.2	0.126	0.886	14.2	Pass
9	0.414	3.545	11.7	0.442	5.317	8.3	Pass
10	0.088	0.473	18.7	0.168	0.709	23.7	Pass
11	0.399	2.954	13.5	0.463	4.431	10.5	Pass
12	0.082	0.394	20.9	0.151	0.591	25.6	Pass
13	0.408	2.363	17.3	0.532	3.545	15.0	Pass
14	0.069	N/A	N/A	0.128	N/A	N/A	N/A
15	0.173	N/A	N/A	0.197	N/A	N/A	N/A
16	0.075	N/A	N/A	0.115	N/A	N/A	N/A
17	0.161	N/A	N/A	0.213	N/A	N/A	N/A
18	0.034	N/A	N/A	0.062	N/A	N/A	N/A
19	0.139	N/A	N/A	0.178	N/A	N/A	N/A
20	0.028	N/A	N/A	0.052	N/A	N/A	N/A
21	0.079	N/A	N/A	0.093	N/A	N/A	N/A
22	0.025	N/A	N/A	0.047	N/A	N/A	N/A
23	0.085	N/A	N/A	0.101	N/A	N/A	N/A
24	0.015	N/A	N/A	0.035	N/A	N/A	N/A
25	0.087	N/A	N/A	0.106	N/A	N/A	N/A
26	0.017	N/A	N/A	0.032	N/A	N/A	N/A
27	0.037	N/A	N/A	0.043	N/A	N/A	N/A
28	0.014	N/A	N/A	0.027	N/A	N/A	N/A
29	0.059	N/A	N/A	0.064	N/A	N/A	N/A
30	0.011	N/A	N/A	0.018	N/A	N/A	N/A
31	0.054	N/A	N/A	0.059	N/A	N/A	N/A
32	0.014	N/A	N/A	0.025	N/A	N/A	N/A
33	0.027	N/A	N/A	0.032	N/A	N/A	N/A
34	0.012	N/A	N/A	0.020	N/A	N/A	N/A
35	0.042	N/A	N/A	0.045	N/A	N/A	N/A
36	0.010	N/A	N/A	0.017	N/A	N/A	N/A
37	0.033	N/A	N/A	0.035	N/A	N/A	N/A
38	0.009	N/A	N/A	0.014	N/A	N/A	N/A
39	0.016	N/A	N/A	0.019	N/A	N/A	N/A
40	0.006	N/A	N/A	0.011	N/A	N/A	N/A

Note: Measured I-ref was applied for this test.

Voltage Source Verification Data (Phase C-Run time)

EUT: UNINTERRUPTIBLE POWER SYSTEM(HT33030XL) Tested by: Test Operator
 Test category: Table:2, R_{sc}≥350, Inter-Harm, Test Margin: 100
 Test date: 2015/1/21 Start time: 13:49:47 End time: 13:52:39
 Test duration (min): 2.5 Data file name: WIN2106_H-000074.cts_data
 Comment: Full Load
 Customer: YWT

Test Result: Pass Source qualification: Distorted
 Current harmonics are corrected for source distortion, and are within +/-5%
 Measurements are compliant with IEC/EN61000-3-12 Ed.2 (2011) & IEC/EN61000-4-7

Highest parameter values during test:

Voltage (Vrms):	222.80	Frequency(Hz):	50.00
I _{Peak} (Amps):	44.990	I _{RMS} (Amps):	29.780
I _{Fund} (Amps):	29.729	Crest Factor:	1.526
Power (Watts):	6597	Power Factor:	0.995

Harm#	Harmonics V-rms	Limit V-rms	% of Limit	Status
2	0.293	0.891	32.84	OK
3	0.388	2.783	13.93	OK
4	0.119	0.891	13.35	OK
5	0.223	3.341	6.68	OK
6	0.076	0.891	8.55	OK
7	0.702	2.784	25.22	OK
8	0.193	0.891	21.68	OK
9	0.939	1.336	70.25	OK
10	0.292	0.891	32.78	OK
11	1.257	1.559	80.60	OK
12	0.334	0.668	49.93	OK
13	1.476	1.336	110.48	Dist.
14	0.318	0.668	47.59	OK
15	0.897	0.668	134.30	Dist.
16	0.350	0.668	52.40	OK
17	1.012	0.668	151.40	Dist.
18	0.180	0.668	26.99	OK
19	0.851	0.668	127.33	Dist.
20	0.187	0.668	27.98	OK
21	0.469	0.668	70.18	OK
22	0.149	0.668	22.35	OK
23	0.590	0.668	88.22	OK
24	0.149	0.668	22.32	OK
25	0.551	0.668	82.48	OK
26	0.131	0.668	19.63	OK
27	0.260	0.668	38.85	OK
28	0.142	0.668	21.27	OK
29	0.365	0.668	54.62	OK
30	0.078	0.668	11.65	OK
31	0.336	0.668	50.23	OK
32	0.164	0.668	24.56	OK
33	0.198	0.668	29.67	OK
34	0.088	0.668	13.14	OK
35	0.268	0.668	40.04	OK
36	0.089	0.668	13.34	OK
37	0.215	0.668	32.15	OK
38	0.083	0.668	12.45	OK
39	0.116	0.668	17.34	OK
40	0.060	0.668	8.94	OK

5th Harmonic Phase Angle and Magnitude for Phase A :**H-5_min_phase : 135.5 Degree (Leading)****H-5_max_phase : 335.8 Degree (Leading)****H-5_ave_phase : 250.8 Degree (Leading)****H-5_ave_vector_magnitude : 0.069 Amp****H-5_standard_ave_magnitude : 0.150 Amp****H-5_standard_max_magnitude : 0.179 Amp****Ratio of H-5_ave_vector / H-5_standard_ave : 0.461****Phase A = 23.173% of tested Rsce = 350.000, Rsce = 81.104****Phase B = 22.524% of tested Rsce = 350.000, Rsce = 78.833****Phase C = 25.582% of tested Rsce = 350.000, Rsce = 89.536****Minimum Rsce required: Rsce = 89.536**

7. VOLTAGE FLUCTUATION AND FLICKER MEASUREMENT

7.1. Block Diagram of Test Setup

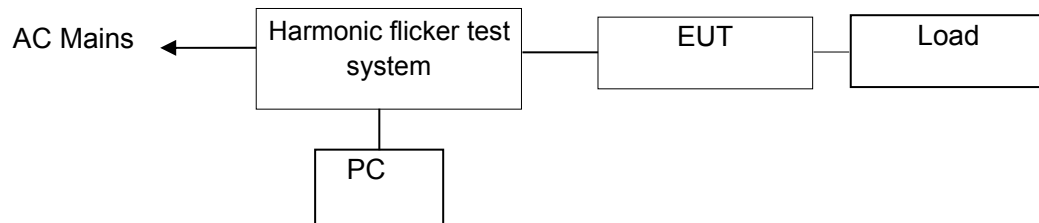

(EUT: Uninterruptible Power Supply)

7.2. Measuring Standard

EN 61000-3-11: 2000

7.3. Operation Condition of EUT

Same as Section 4.4, except the test setup replaced as Section 7.1.

7.4. Measuring Results

PASS.

Please see the attached page.

Flicker Test Summary (Phase A-Run time) per EN/IEC61000-3-11

EUT: UNINTERRUPTIBLE POWER SYSTEM(HT33030XL) Tested by: CSL
 Test category: All parameters Test Margin: 100
 Test date: 2015/1/21 Start time: 14:11:04 End time: 14:21:38
 Test duration (min): 10 Data file name: WIN2106_F-000076.cts_data
 Comment: FULL LOAD
 Customer: YWT
 Z-test Phase = (0.150 + j 0.150 Ohm) Neutral = (0.100 + j 0.100 Ohm)

Test Result: Pass
Status: Test Completed

Pst_i and limit line

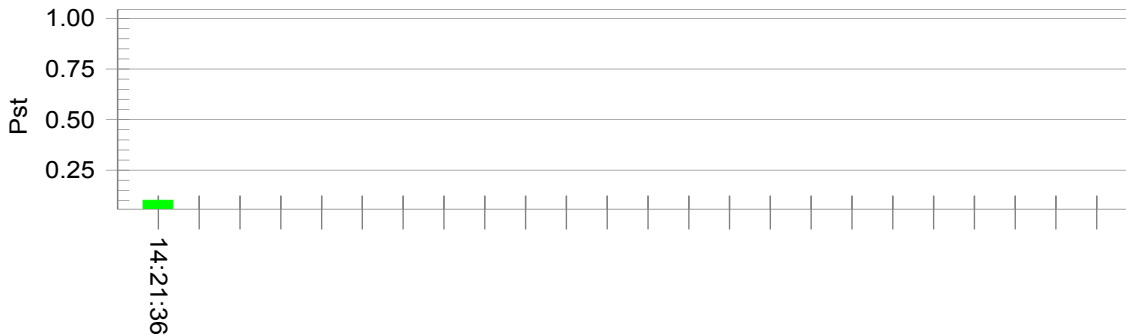

Plt and limit line

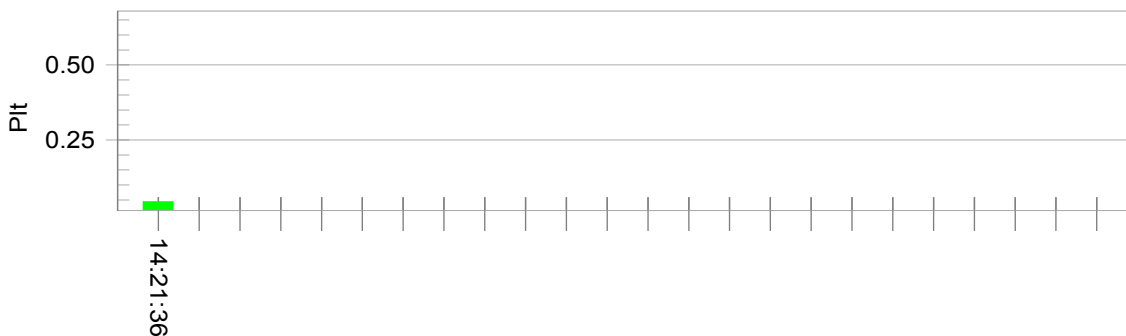

Parameter values recorded during the test:

Vrms at the end of test (Volt): 223.51

Time(mS) > dt:	0.0	Test limit (mS):	500.0	Pass
Highest dc (%):	0.00	Test limit (%):	3.30	Pass
Highest dmax (%):	0.00	Test limit (%):	4.00	Pass
Highest Pst (10 min. period):	0.102	Test limit:	1.000	Pass
Highest Plt (2 hr. period):	0.044	Test limit:	0.650	Pass

Calculated dmax(%): 0.000
 Calculated dc(%): 0.000

Calculated Pst : 0.136
Calculated Plt : 0.059

The maximum permissible system impedance Zsys:

Z-phase A = 1.767 Ohm + j 1.104 Ohm	(1.767 Ohm + 3515 ?H)
Z-neutral A = 1.178 Ohm + j 0.736 Ohm	(1.178 Ohm + 2343 ?H)

8. IMMUNITY PERFORMANCE CRITERIA DESCRIPTION

Performance Level

The test results shall be classified in terms of the loss of function or degradation of performance of the equipment under test, relative to a performance level by its manufacturer or the requestor of the test, or the agreed between the manufacturer and the purchaser of the product.

Definition related to the performance level:

1. Based on the used product standard
2. Based on the declaration of the manufacturer, requestor or purchaser

Criterion A:

Definition: normal performance within limits specified by the manufacturer, requestor and purchaser.

The equipment shall continue to operate as intended without operator intervention. No degradation of performance or loss of function is allowed below a performance level specified by the manufacturer when the equipment is used as intended. The performance level may be replaced by a permissible loss of performance. If the minimum performance level or the permissible performance loss is not specified by the manufacturer, then either of these may be derived from the product description and documentation, and by what the user may reasonably expect from the equipment if used as intended.

Criterion B:

Definition: temporary loss of function or degradation of performance which ceases after the disturbance ceases, and from which the equipment under test recovers its normal performance, without operator intervention.

After the test, the EUT shall continue to operate as intended without operator intervention. No degradation of performance or loss of function is allowed, after the application of the phenomena below a performance level specified by the manufacturer, when the EUT is used as intended. The performance level may be replaced by a permissible loss of performance. During the test, degradation of performance is allowed. However, no change of operating state or stored data is allowed to persist after the test. If the minimum performance level (or the permissible performance loss) is not specified by the manufacturer, then either of these may be derived from the product description and documentation, and by what the user may reasonably expect from the EUT if used as intended.

Criterion C:

Definition: temporary loss of function or degradation of performance, the correction of which requires operator intervention.

Loss of function is allowed, provided the function is self-recoverable, or can be restored by the operation of the controls by the user in accordance with the manufacturer's instructions. Functions, and/or information stored in non-volatile memory, or protected by a battery backup, shall not be lost.

Criterion D

Definition: loss of function or degradation of performance, which is not recoverable, owing to damage to hardware or software, or loss of data.

9. ELECTROSTATIC DISCHARGE IMMUNITY TEST

9.1. Block Diagram of Test Setup

9.1.1. Block diagram of connection between the EUT and simulators



(EUT: Uninterruptible Power Supply)

9.1.2. Block diagram of ESD test setup

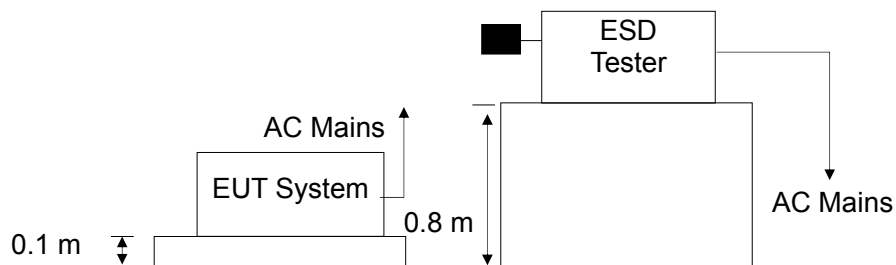

(EUT: Uninterruptible Power Supply)

9.2. Test Standard

IEC 61000-4-2:2008 (Air Discharge: ± 8 kV, Contact Discharge: ± 4 kV)

9.3. Severity Levels and Performance Criterion

9.3.1. Severity level

Level	Test Voltage Contact Discharge (kV)	Test Voltage Air Discharge (kV)
1.	± 2	± 2
2.	± 4	± 4
3.	± 6	± 8
4.	± 8	± 15
X	Special	Special

9.3.2.Performance criterion : B

	Criterion B
Output characteristics	Voltage permitted to vary within the inverse time characteristics applicable (<100 m sec limits in Figures 1, 2 or 3 of IEC 62040-3)
External and internal indications and metering	Change only during test
Control signals to external devices	Change only temporarily in consistency with the actual Uninterruptible Power Supply mode of operation
Mode of operation	Change only temporarily

9.4. EUT Configuration

The configuration of EUT are listed in Section 4.3.

9.5. Operating Condition of EUT

Same as conducted emission measurement, which is listed in Section 4.4. except the test set up replaced by Section 7.1.

9.6. Test Procedure

9.6.1.Air Discharge:

This test is done on a non-conductive surface. The round discharge tip of the discharge electrode shall be approached as fast as possible to touch the EUT. After each discharge, the discharge electrode shall be removed from the EUT. The generator is then re-triggered for a new single discharge and repeated 10 times for each pre-selected test point. This procedure shall be repeated until all the air discharge completed

9.6.2.Contact Discharge:

All the procedure shall be same as Section 9.6.1. except that the tip of the discharge electrode shall touch the EUT before the discharge switch is operated.

9.6.3.Indirect discharge for horizontal coupling plane

At least 10 single discharges(in the most sensitive polarity) shall be applied at the front edge of each HCP opposite the center point of each unit(if applicable) of the EUT and 0.1m from the front of the EUT. The long axis of the discharge electrode shall be in the plane of the HCP and perpendicular to its front edge during the discharge.

9.6.4.Indirect discharge for vertical coupling plane

At least 10 single discharge (in the most sensitive polarity) shall be applied to the center of one vertical edge of the coupling plane. The coupling plane, of dimensions 0.5m X 0.5m, is placed parallel to, and positioned at a distance of 0.1m from the EUT. Discharges shall be applied to the coupling plane, with this plane in sufficient different positions that the four faces of the EUT are completely illuminated.

9.7. Test Results

PASS

Please refer to the following page.

Electrostatic Discharge Test Result

EMTEK(SHENZHEN) CO., LTD.

Applicant : INVT POWER SYSTEM (SHENZHEN) CO., LTD. <hr/> EUT : Uninterruptible Power Supply <hr/> M/N : HT33030XL <hr/> Power Supply : AC 380V/50Hz <hr/> Test Mode : Line mode, Bat mode <hr/> Test Engineer : CL	Test Date : January 26, 2015 <hr/> Temperature : 22°C <hr/> Humidity : 50% <hr/> Actual Criterion : B <hr/> Air discharge : ±8kV <hr/> Contact discharge : ±4kV	
Location	Kind A-Air Discharge C-Contact Discharge	Result
Screen	A	A
Button	A	A
Slot	A	A
Metal	C	A
Port	C	A
HCP	C	A
VCP of front	C	A
VCP of rear	C	A
VCP of left	C	A
VCP of right	C	A
Test Equipment: ESD Simulator (TESEQAG, NSG 437)		

10. RF FIELD STRENGTH SUSCEPTIBILITY TEST

10.1. Block Diagram of Test

10.1.1. Block diagram of connection between the EUT and Load



(EUT: Uninterruptible Power Supply)

10.1.2. Block diagram of RS test setup

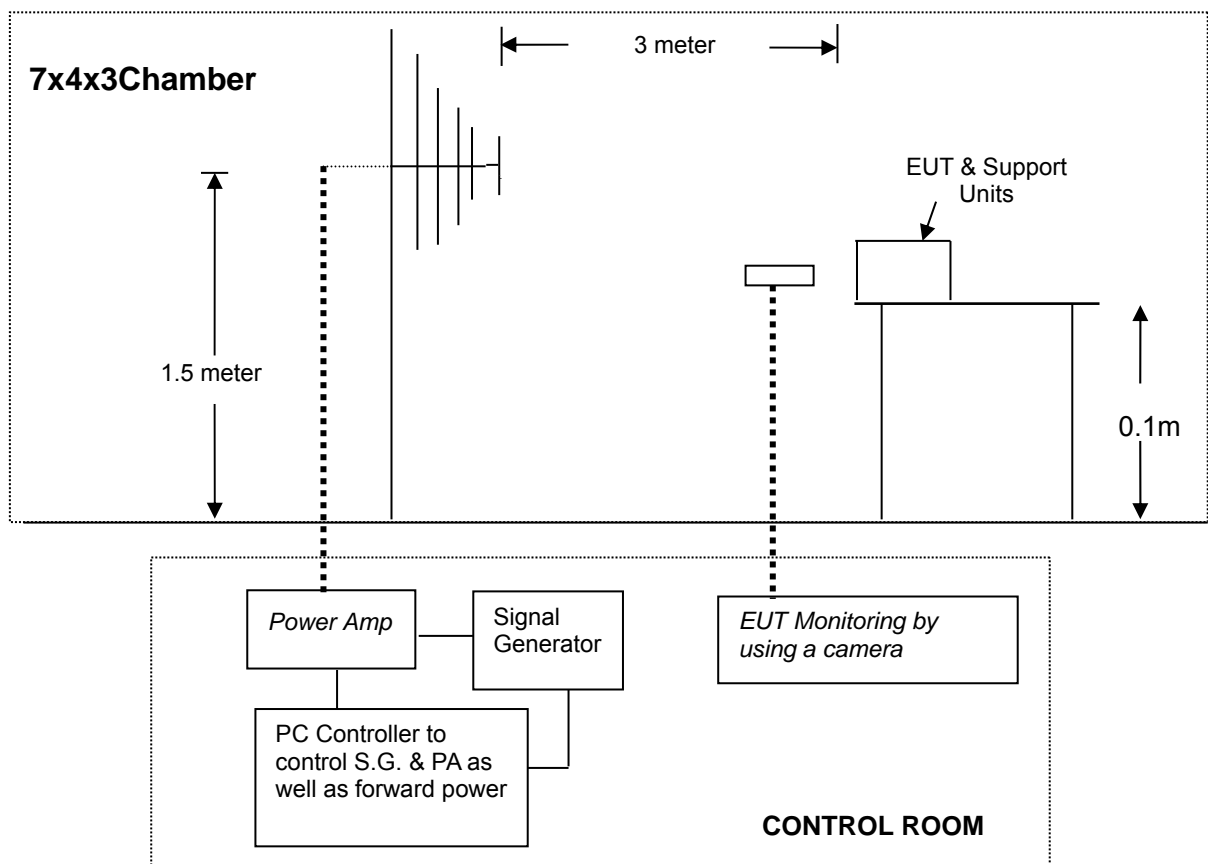

(EUT: Uninterruptible Power Supply)

10.2. Test Standard

IEC 61000-4-3:2006+A1:2007+A2:2010 (level 3: 10V / m)

10.3. Severity Levels and Performance Criterion

10.3.1. Severity Levels

Level	Field Strength V/m
1.	1
2.	3
3.	10
X	Special

10.3.2. Performance Criterion : A

	Criterion A
External and internal indications and metering (LCD)	No change
Output characteristics (Load)	No change
Control signals to external devices (Signal line)	No change
Mode of operation	No change

10.4. EUT Configuration on Test

The configuration of the EUT is same as Section 4.3.

10.5. Operating Condition of EUT

Same as radiated emission measurement which is listed in Section 4.4, except the test setup replaced as Section 10.1.

10.6. Test Procedure

The EUT is placed on a table which is 0.1m high above the ground. The EUT is set 3 meters away from the transmitting antenna which is mounted on an antenna tower. Both horizontal and vertical polarization of the antenna are set on test. Each of the four sides of the EUT must be faced this transmitting antenna and measured individually.

In order to judge the EUT performance, a CCD camera is used to monitor its screen. All the scanning conditions are as following:

Condition of Test	Remark
1. Fielded Strength	10V/m
2. Radiated Signal	Modulated
3. Scanning Frequency	80-1000MHz
4. Sweep time of radiated	0.0015 Decade/s
5. Dwell Time	1 Sec.

10.7. Test Results

PASS.

Please refer to the following page.

RF Field Strength Susceptibility Test Results

EMTEK(SHENZHEN) CO., LTD..

<p>Applicant : INVT POWER SYSTEM (SHENZHEN) CO., LTD.</p> <hr/> <p>EUT : Uninterruptible Power Supply</p> <hr/> <p>M/N : HT33030XL</p> <hr/> <p>Field Strength : 10V/m</p> <hr/> <p>Power Supply : AC 380V/50Hz</p> <hr/> <p>Test Engineer : CL</p> <hr/>	<p>Test Date : January 26, 2015</p> <hr/> <p>Temperature : 22°C</p> <hr/> <p>Humidity : 50%</p> <hr/> <p>Actual Criterion : A</p> <hr/> <p>Test Mode : Line mode, Bat mode</p> <hr/> <p>Frequency Range : 80 to 1000 MHz</p> <hr/>		
<p>Modulation: <input type="checkbox"/>None <input type="checkbox"/>Pulse <input checked="" type="checkbox"/>AM 1KHz 80%</p>			
<p>Frequency Rang 1: 80~ 1000MHz</p>			
<p>Frequency Rang 2: N/A</p>			
Steps	# / %	# / %	# / %
	Horizontal	Vertical	Horizontal
Front	A	A	
Right	A	A	
Rear	A	A	
Left	A	A	
<p>Test Equipment :</p> <ol style="list-style-type: none"> 1. Signal Generator: N5181A (Agilent) 2. Power Amplifier: 80RF1000-175 (MILMEGA) & AS1860-50 (MILMEGA) 3. Log.-Per. Antenna: VULP 9118E (SCHWARZBECK) 4. RF Power Meter. Dual Channel: 4232A (BOONTON) 5. Field Strength Meter: RSS1006A (DARE) 			
<p>Note: /</p>			

11. ELECTRICAL FAST TRANSIENT/BURST IMMUNITY TEST

11.1. Block Diagram of Test Setup

11.1.1. Block Diagram of the EUT



(EUT: Uninterruptible Power Supply)

11.1.2. EFT Test Setup

AC Port:

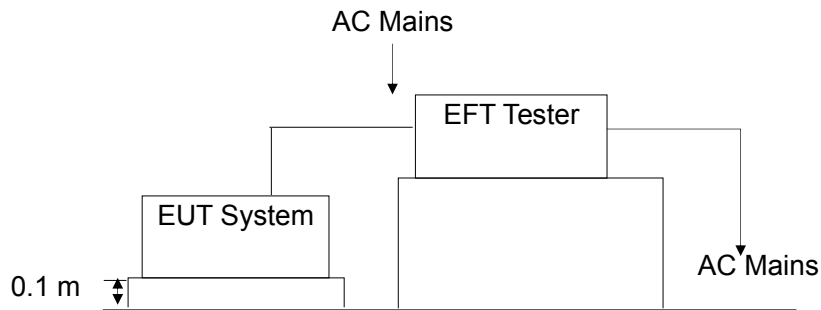

(EUT: Uninterruptible Power Supply)

11.2. Test Standard

IEC 61000-4-4:2012 (Level 3: 2kV/5kHz for AC input power ports)

11.3. Severity Levels and Performance Criterion

11.3.1. Severity level

Open Circuit Output Test Voltage $\pm 10\%$		
Level	On Power Supply Lines	On I/O (Input/Output) Signal data and control lines
1.	0.5 kV	0.25 kV
2.	1 kV	0.5 kV
3.	2 kV	1 kV
4.	4 kV	2 kV
X	Special	Special

11.3.2.Performance criterion : B

	Criterion B
Output characteristics	Voltage permitted to vary within the inverse time characteristics applicable (<100 m sec limits in Figures 1, 2 or 3 of IEC 62040-3)
External and internal indications and metering	Change only during test
Control signals to external devices	Change only temporarily in consistency with the actual Uninterruptible Power Supply mode of operation
Mode of operation	Change only temporarily

11.4.EUT Configuration

The configuration of EUT is listed in Section 4.4.

11.5.Operating Condition of EUT

11.5.1.Setup the EUT as shown in Section 11.1.

11.5.2.Turn on the power of all equipments.

11.5.3.Let the EUT work in test mode (Line mode) and measure it.

11.6.Test Procedure

The EUT is put on the table which is 0.1m high above the ground. This reference ground plane shall project beyond the EUT by at least 0.1m on all sides and the minimum distance between EUT and all other conductive structure, except the ground plane beneath the EUT, shall be more than 0.5m.

11.6.1. For input and output AC power ports:

The EUT is connected to the power mains by using a coupling device which couples the EFT interference signal to AC power lines. Both polarities of the test voltage should be applied during compliance test and the duration of the test is 2 mins.

11.6.2. For signal line and control lines ports:

It's unnecessary to test.

11.6.3. For DC output line ports:

It's unnecessary to test.

11.7.Test Result

PASS.

Please refer to the following page.

Electrical Fast Transient/Burst Test Results

EMTEK(SHENZHEN) CO., LTD..

Standard	IEC 61000-4-4	Result: <input checked="" type="checkbox"/> PASS / <input type="checkbox"/> FAIL	
Applicant : <u>INVT POWER SYSTEM (SHENZHEN) CO., LTD.</u> EUT : <u>Uninterruptible Power Supply</u> M/N : <u>HT33030XL</u> Input Voltage : <u>AC 380V/50Hz</u> Actual Criterion : <u>B</u> Ambient Condition : <u>23 °C</u> <u>55% RH</u>			
Operation Mode: Line mode			
Line : <input checked="" type="checkbox"/> AC input power ports		Line : <input type="checkbox"/> Signal <input type="checkbox"/> I/O Cable	
Coupling : <input checked="" type="checkbox"/> Direct		Coupling : <input type="checkbox"/> Capacitive	
Test Time : 120s			
Line	Test Voltage	Result(+)	Result(-)
L1, L2, L3, N, PE	2kV	A	A
L1-L2, L1-L3, L2-L3, L1-N, L2-N, L3-N	2kV	A	A
L1-PE, L2-PE, L3-PE, N-PE	2kV	A	A
L1-L2-PE, L1-L3-PE, L2-L3-PE, L1-L2-L3, L1-L2-N, L1-L3-N, L2-L3-N, L1-N-PE, L2-N-PE, L3-N-PE	2kV	A	A
L1-L2-L3-PE, L1-L2-L3-N, L1-L2-N-PE, L1-L3-N-PE, L2-L3-N-PE	2kV	A	A
AC output power ports: L1, L2, L3, N, PE	2kV	A	A
L1-L2, L1-L3, L2-L3, L1-N, L2-N, L3-N	2kV	A	A
L1-PE, L2-PE, L3-PE, N-PE	2kV	A	A
L1-L2-PE, L1-L3-PE, L2-L3-PE, L1-L2-L3, L1-L2-N, L1-L3-N, L2-L3-N, L1-N-PE, L2-N-PE, L3-N-PE	2kV	A	A
L1-L2-L3-PE, L1-L2-L3-N, L1-L2-N-PE, L1-L3-N-PE, L2-L3-N-PE	2kV	A	A
Note:			
Test Equipment		Burst Tester Model : PEFT 4010	

12. SURGE IMMUNITY TEST

12.1. Block Diagram of Test Setup

12.1.1. Block Diagram of the EUT



(EUT: Uninterruptible Power Supply)

12.1.2. Surge Test Setup

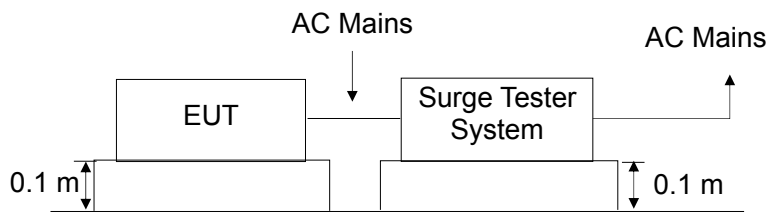

(EUT: Uninterruptible Power Supply)

12.2. Test Standard

IEC 61000-4-5:2014 (Line to Line: Level 2, 1.0kV, Line to earth: Level 3, 2.0kV)

12.3. Severity Levels and Performance Criterion

12.3.1. Severity level

Severity Level	Open-Circuit Test Voltage kV
1	0.5
2	1.0
3	2.0
4	4.0
*	Special

12.3.2. Performance criterion: B

	Criterion B
Output characteristics	Voltage permitted to vary within the inverse time characteristics applicable (<100 m sec limits in Figures 1, 2 or 3 of IEC 62040-3)
External and internal indications and metering	Change only during test
Control signals to external devices	Change only temporarily in consistency with the actual Uninterruptible Power Supply mode of operation
Mode of operation	Change only temporarily

12.4.EUT Configuration

The configuration of EUT is listed in Section 4.3.

12.5.Operating Condition of EUT

12.5.1.Setup the EUT as shown in Section 12.1.

12.5.2.Turn on the power of all equipments.

12.5.3.Let the EUT work in test mode (Line mode) and measure it.

12.6.Test Procedure

- 1) Set up the EUT and test generator as shown on Section 12.1.2.
For line to line coupling mode, provide 1kV 1.2/50us voltage surge.
For line to earth mode, provide 2kV 1.2/50us voltage surge.
(At open-circuit condition) and 8/20us current surge to EUT selected points.
- 2) At least 5 positive and 5 negative (polarity) tests with a maximum 1/min repetition rate are conducted during test.
- 3) Different phase angles are done individually.
- 4) Record the EUT operating situation during compliance test and decide the EUT immunity criterion for above each test.

12.7.Test Result

PASS.

Please refer to the following page.

Surge Immunity Test Result

EMTEK(SHENZHEN) CO., LTD..

Applicant : INVT POWER SYSTEM (SHENZHEN) CO., LTD.

Test Engineer: CL

EUT : Uninterruptible Power Supply

Test Date : January 23, 2015

M/N : HT33030XL

Temperature : 23°C

Power Supply : AC 380V / 50Hz

Humidity : 51%

Test Mode : Line mode

Criterion : B

Location	Polarity	Phase Angle	Number of Pulse	Pulse Voltage (kV)	Result
AC Input: L1-L2, L1-L3, L2-L3	+	0°, 90°, 180°, 270°	5	1.0	A
	-	0°, 90°, 180°, 270°	5	1.0	A
L1-N, L2-N, L3-N	+	0°, 90°, 180°, 270°	5	1.0	A
	-	0°, 90°, 180°, 270°	5	1.0	A
L1-PE, L2-PE, L3-PE	+	0°, 90°, 180°, 270°	5	2.0	A
	-	0°, 90°, 180°, 270°	5	2.0	A
N-PE	+	0°, 90°, 180°, 270°	5	2.0	A
	-	0°, 90°, 180°, 270°	5	2.0	A
AC Output: L1-L2, L1-L3, L2-L3	+	Random	5	1.0	A
	-	Random	5	1.0	A
L1-PE, L2-PE, L3-PE	+	Random	5	1.0	A
	-	Random	5	1.0	A
L1-PE, L2-PE, L3-PE	+	Random	5	2.0	A
	-	Random	5	2.0	A
N-PE	+	Random	5	2.0	A
	-	Random	5	2.0	A

Note:

13. INJECTED CURRENTS SUSCEPTIBILITY TEST

13.1. Block Diagram of Test Setup

13.1.1. Block Diagram of the EUT



(EUT: Uninterruptible Power Supply)

13.1.2. Block Diagram of Test Setup

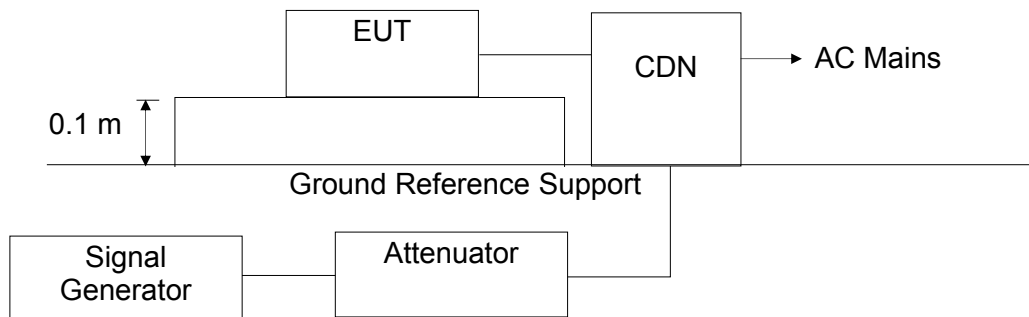

13.2. Test Standard

IEC 61000-4-6:2013 (Level 3: 10V (rms) (0.15MHz ~ 80MHz))

13.3. Severity Levels and Performance Criterion

13.3.1. Severity level

Level	Field Strength V
1	1
2	3
3	10
X	Special

13.3.2. Performance criterion: A

	Criterion A
External and internal indications and metering (LCD)	No change
Output characteristics (Load)	No change
Control signals to external devices (Signal line)	No change
Mode of operation	No change

13.4.EUT Configuration

The configuration of EUT is listed in Section 4.3.

13.5.Operating Condition of EUT

13.5.1.Setup the EUT as shown in Section 13.1.

13.5.2.Turn on the power of all equipments.

13.5.3.Let the EUT work in test mode (Line mode) and measure it.

13.6.Test Procedure

- 1) Set up the EUT, CDN and test generators as shown on Section 13.1.2.
- 2) Let the EUT work in test mode and measure it.
- 3) The EUT are placed on an insulating support 0.1m high above a ground reference plane. CDN (coupling and decoupling device) is placed on the ground plane about 0.3m from EUT. Cables between CDN and EUT are as short as possible, and their height above the ground reference plane shall be between 30 and 50 mm (where possible).
- 4) The disturbance signal described below is injected to EUT through CDN.
- 5) The EUT operates within its operational mode(s) under intended climatic conditions after power on.
- 6) The frequency range is swept from 150KHz to80MHz using 10V signal level, and with the disturbance signal 80% amplitude modulated with a 1KHz sine wave.
- 7) The rate of sweep shall not exceed $1.5 \cdot 10^{-3}$ decades/s. Where the frequency is swept incrementally, the step size shall not exceed 1% of the start and thereafter 1% of the preceding frequency value.
- 8) Recording the EUT operating situation during compliance testing and decide the EUT immunity criterion.

13.7.Test Results

PASS.

Please refer to the following page.

Injected Currents Susceptibility Test Results

EMTEK(SHENZHEN) CO., LTD..

Applicant : <u>INVT POWER SYSTEM (SHENZHEN) CO., LTD.</u>		Test Date : <u>January 23, 2015</u>		
EUT : <u>Uninterruptible Power Supply</u>		Temperature : <u>23°C</u>		
M/N : <u>HT33030XL</u>		Humidity : <u>50%</u>		
Power Supply : <u>AC 380V/50Hz</u>		Actual Criterion : <u>A</u>		
Test Engineer : <u>CL</u>				
Test Mode : Line mode				
Frequency Range (MHz)	Injected Position	Strength (Unmodulated)	Criterion	Result
0.15 ~ 80	AC Input	10V	A	A
0.15 ~ 80	AC Output	10V	A	A
Remark : 1. Modulation Signal:1KHz 80% AM Measurement Equipment : Simulator: CIT-10 (SWITZERLAND EMTEST) CDN : <input type="checkbox"/> CDN-M332 (SWITZERLAND EMTEST) <input type="checkbox"/> CDN-M432 (SWITZERLAND EMTEST) <input checked="" type="checkbox"/> CDN-M532 (SWITZERLAND EMTEST) <input type="checkbox"/> Injection Clamp (EMTEST F-2031-23MM)			Note: /	

14. MAGNETIC FIELD SUSCEPTIBILITY TEST

14.1. Block Diagram of Test

14.1.1. Block diagram of test setup



(EUT: Uninterruptible Power Supply)

14.1.2. Magnetic field test setup

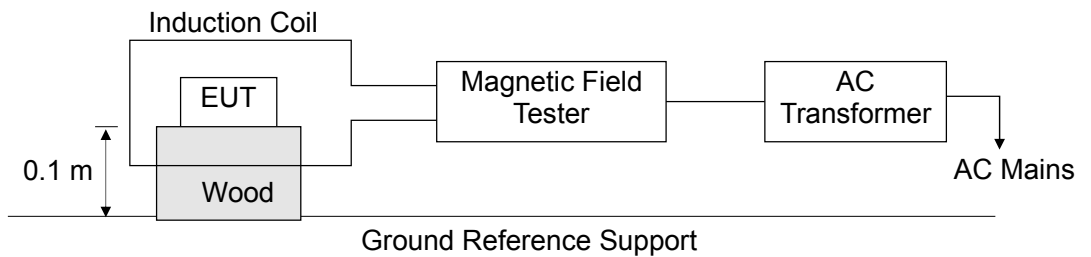

(EUT: Uninterruptible Power Supply)

14.2. Test Standard

IEC 61000-4-8:2009, (Severity Level 4: 30A / m)

14.3. Severity Levels and Performance Criterion

14.3.1. Severity Levels

Level	Field Strength A/m
1	1
2	3
3	10
4	30
5	100
X	Special

14.3.2.Performance Criterion: A

	Criterion A
Output characteristics	Voltage permitted to vary within the inverse time characteristics applicable (<100 m sec limits in Figures 1, 2 or 3 of IEC 62040-3)
External and internal indications and metering	Change only during test
Control signals to external devices	Change only temporarily in consistency with the actual Uninterruptible Power Supply mode of operation
Mode of operation	Change only temporarily

14.4.EUT Configuration on Test

The configuration of the EUT is same as Section 4.3.

14.5.Test Procedure

The EUT is placed in the middle of a induction coil (1*1m), under which is a 1*1*0.1m (high) table, this small table is also placed on a larger table, 0.8 m above the ground. Both horizontal and vertical polarization of the induction coil is set on test, so that each side of the EUT is affected by the magnetic field. Also can reach the same aim by change the position of the EUT.

14.6.Test Results

PASS.

Please refer to the following page.

Magnetic Field Immunity Test Result

EMTEK(SHENZHEN) CO., LTD..

Standard	IEC 61000-4-8		Result: <input checked="" type="checkbox"/> Pass / <input type="checkbox"/> Fail	
<p>Applicant : <u>INVT POWER SYSTEM (SHENZHEN) CO., LTD.</u></p> <p>EUT : <u>Uninterruptible Power Supply</u> M/N : <u>HT33030XL</u></p> <p>Input Voltage : <u>AC 380V/50Hz</u></p> <p>Date of Test : <u>January 26, 2015</u> Test Engineer : <u>CL</u></p> <p>Ambient Condition : Temp : <u>22°C</u> Humid : <u>50%</u></p> <p>Actual Criterion : A</p>				
Operation Mode : Line mode, Bat mode				
Test Level (A/M)	Testing Duration	Coil Orientation	Criterion	Result
30	5 mins	X	A	A
30	5 mins	Y	A	A
30	5 mins	Z	A	A
Operation Mode : N/A				
Test Level (A/M)	Testing Duration	Coil Orientation	Criterion	Result
Test Equipment	Magnetic Field Test : HEAFELY MAG 100.1			
Note: /				

15. VOLTAGE DIPS AND INTERRUPTIONS TEST

15.1. Block Diagram of Test Setup

15.1.1. Block Diagram of the EUT



(EUT: Uninterruptible Power Supply)

15.1.2. Dips Test Setup

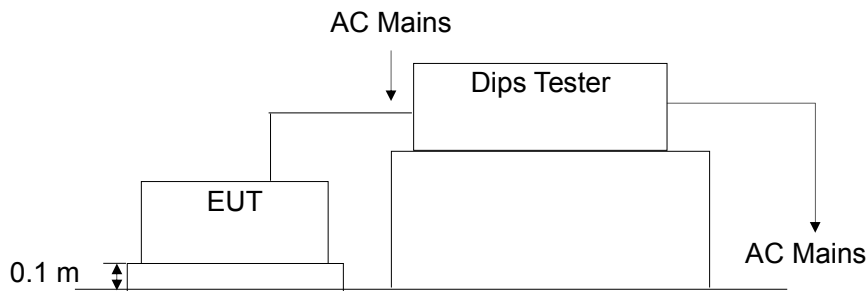

(EUT: Uninterruptible Power Supply)

15.2. Test Standard

IEC 61000-4-11:2004

15.3. Severity Levels and Performance Criterion

15.3.1. Severity level

Test Level %UT	Voltage dip and short interruptions %UT	Duration (in period)
0	100	0.5
40	60	1
70	30	5
		10
		25
		50
		*

15.3.2.Performance criterion: B

	Criterion B
Output characteristics	Voltage permitted to vary within the inverse time characteristics applicable (<100 m sec limits in Figures 1, 2 or 3 of IEC 62040-3)
External and internal indications and metering	Change only during test
Control signals to external devices	Change only temporarily in consistency with the actual Uninterruptible Power Supply mode of operation
Mode of operation	Change only temporarily

15.4.EUT Configuration

The configuration of EUT is listed in Section 4.3.

15.5.Operating Condition of EUT

15.5.1.Setup the EUT as shown in Section 15.1.

15.5.2.Turn on the power of all equipments.

15.5.3.Let the EUT work in test mode (Line mode) and measure it.

15.6.Test Procedure

- 1) Set up the EUT and test generator as shown on Section 15.1.2.
- 2) The interruption is introduced at selected phase angles with specified duration.
- 3) Record any degradation of performance.

15.7.Test Result

PASS.

Please refer to the following page.

Voltage Dips And Interruptions Test Results

EMTEK(SHENZHEN) CO., LTD..

Applicant : <u>INVT POWER SYSTEM (SHENZHEN) CO., LTD.</u>		Test Date : <u>January 26, 2015</u>		
EUT : <u>Uninterruptible Power Supply</u>		Temperature : <u>22°C</u>		
M/N : <u>HT33030XL</u>		Humidity : <u>50%</u>		
Power Supply : <u>AC 380V/50Hz</u>		Test Engineer : <u>DK</u>		
Test Mode: Line mode				
Test Level % U _T	Voltage Dips & Short Interruptions % U _T	Duration (in periods)	Criterion <input type="checkbox"/> A <input checked="" type="checkbox"/> B <input type="checkbox"/> C <input type="checkbox"/> D	Result
0	100	0.5P	B	A
40	60	10P	B	A
70	30	25P	B	A
0	100	250P	B	A
Note:				

16. LOW FREQUENCY SIGNALS TEST

16.1. Block Diagram of Test Setup

15.1.1 Block Diagram of the EUT

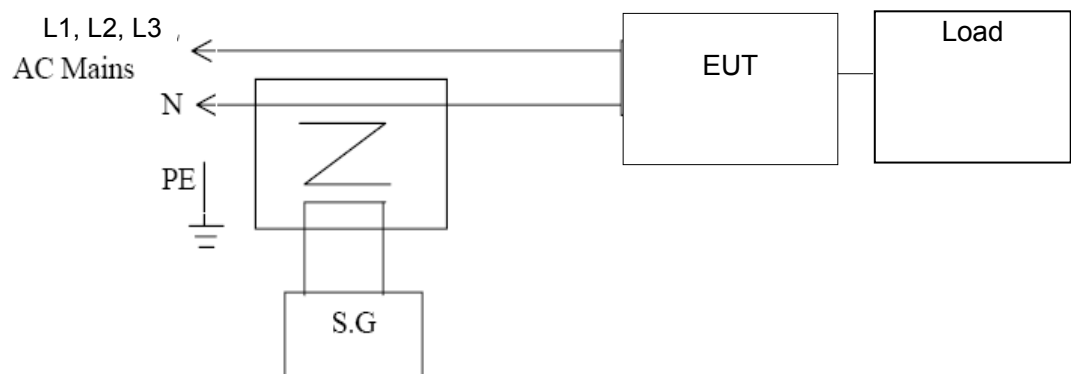

(EUT: Uninterruptible Power Supply)
Note: Above test setup is worst case by pretest.

16.2. Test Standard

IEC 61000-2-2:2002, Performance: A

	Criterion A
External and internal indications and metering (LCD)	No change
Output characteristics (Load)	No change
Control signals to external devices (Signal line)	No change
Mode of operation	No change

16.3. Operating Condition of EUT

Same as Section 4.4, Except the test setup replaced by Section 16.1.

16.4. Test Results

PASS.

Please refer to following page.

Low Frequency Signals Test Result

EMTEK(SHENZHEN) CO., LTD..

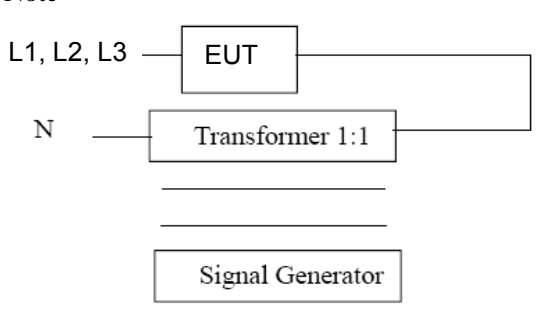
Applicant : <u>INVT POWER SYSTEM (SHENZHEN) CO., LTD.</u> EUT : <u>Uninterruptible Power Supply</u> M/N : <u>HT33030XL</u> Power Supply : <u>AC 380V/50Hz</u> Test Engineer : <u>CL</u>			Test Date : <u>January 26, 2015</u> Temperature : <u>22°C</u> Humidity : <u>58%</u> Test Mode : <u>Line mode</u> Actual Criterion : <u>A</u>	
Frequency Range (Hz)	Position	Strength	Result	Note
140	See Fig.1	10V(rms) Sinusoidal	A	/
160			A	/
200			A	/
240			A	/
280			A	/
320			A	/
360			A	/
Note  <p style="text-align: center;">Fig.1</p>			Test Equipment: 1. Isolation transformer Primary: Secondary=1:1 2. Signal Generator AC Source: 6530(Chroma)	

17. TEST PHOTOGRAPH

17.1.Photos of Conducted Emission Measurement



17.2.Photo of Radiation Emission Measurement

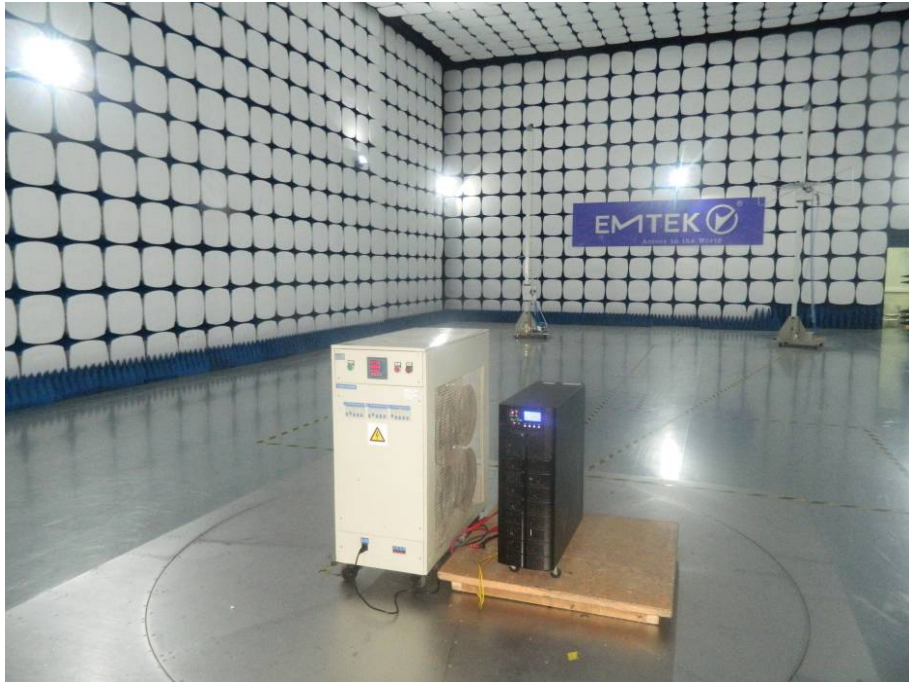

17.3.Photo of Electrostatic Discharge Test



17.4.Photo of RF Field Strength susceptibility Test

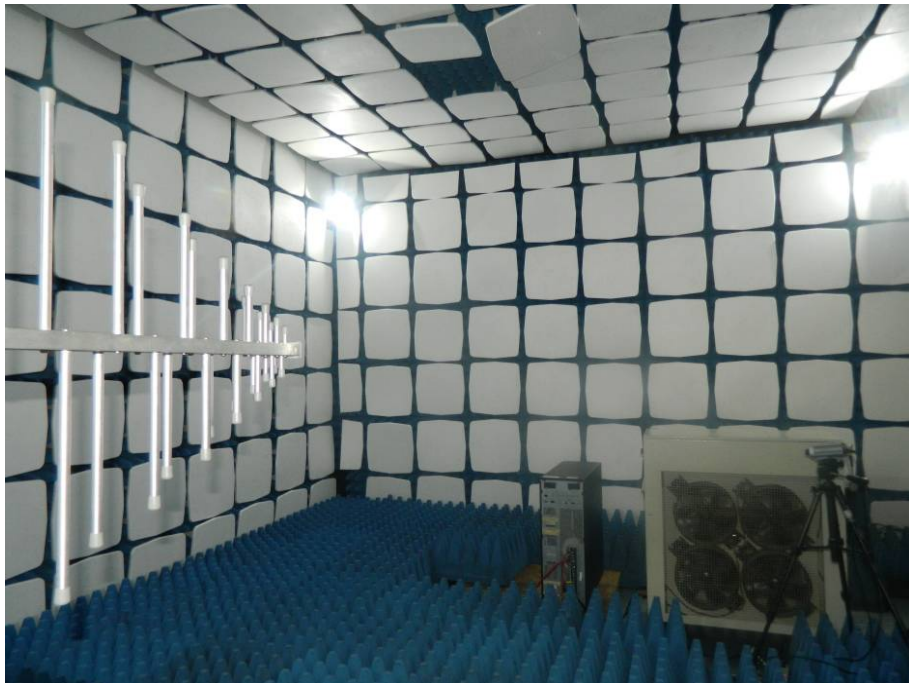

17.5.Photos of Electrical Fast Transient/Burst Test



17.6.Photo of Surge Test



17.7.Photo of Injected Currents Susceptibility Test



17.8.Photo of Magnetic Field Immunity Test



17.9.Photo of Voltage dips and interruption Test



17.10.Photo of Low Frequency Signals Test



APPENDIX (Photos of EUT)



