

Standards EN62040-2: 2006

## TEST REPORT

For

INVT POWER SYSTEM (SHENZHEN) CO., LTD.

Uninterruptible Power Systems

Model Number: RM600/30X, RM500/25X, RM400/20X

Prepared for : INVT POWER SYSTEM (SHENZHEN) CO., LTD.  
Address : 5<sup>th</sup> Floor, 1# Building, Gaofa Industrial Park, Longjing,  
Nanshan District, Shenzhen, China, 518055

Prepared by : EMTEK(SHENZHEN) CO., LTD.  
Address : Bldg 69, Majialong Industry Zone,  
Nanshan District, Shenzhen, Guangdong, China

Tel: (0755) 26954280  
Fax: (0755) 26954282

Report Number : ES160523059E  
Date of Test : April 24, 2015 to June 02, 2015  
Date of Report : May 24, 2016

## TABLE OF CONTENT

Description	Page
<b>1. SUMMARY OF TEST RESULT.....</b>	<b>6</b>
<b>2. GENERAL INFORMATION.....</b>	<b>7</b>
2.1. Description of Device (EUT).....	7
2.2. Description of Support Device.....	8
2.3. Description of Test Facility.....	8
2.4. Measurement Uncertainty.....	8
<b>3. MEASURING DEVICE AND TEST EQUIPMENT.....</b>	<b>9</b>
3.1. For Conducted Emission Measurement.....	9
3.2. For Radiated Emission Measurement.....	9
3.3. For Electrostatic Discharge Immunity Test.....	10
3.4. For RF Strength Susceptibility Test.....	10
3.5. For Electrical Fast Transient/Burst Immunity Test.....	10
3.6. For Surge Immunity Test.....	10
3.7. For Injected Current Susceptibility Test.....	11
3.8. For Magnetic Field Immunity Test.....	11
3.9. For Voltage Dips and Interruptions Test.....	11
<b>4. CONDUCTED EMISSION MEASUREMENT.....</b>	<b>12</b>
4.1. Block Diagram of Test Setup.....	12
4.2. Measuring Standard.....	12
4.3. Power Line Conducted Emission Limits (C3).....	12
4.4. EUT Configuration on Measurement.....	12
4.5. Operating Condition of EUT.....	13
4.6. Test Procedure.....	13
4.7. Measuring Results.....	13
<b>5. RADIATED EMISSION MEASUREMENT.....</b>	<b>22</b>
5.1. Block Diagram of Test.....	22
5.2. Measuring Standard.....	22
5.3. Radiated Emission Limits(C3).....	22
5.4. EUT Configuration on Test.....	23
5.5. Operating Condition of EUT.....	23
5.6. Test Procedure.....	23
5.7. Measuring Results.....	23
<b>6. IMMUNITY PERFORMANCE CRITERIA DESCRIPTION.....</b>	<b>27</b>
<b>7. ELECTROSTATIC DISCHARGE IMMUNITY TEST.....</b>	<b>29</b>
7.1. Block Diagram of Test Setup.....	29
7.2. Test Standard.....	29
7.3. Severity Levels and Performance Criterion.....	29
7.4. EUT Configuration.....	30
7.5. Operating Condition of EUT.....	30
7.6. Test Procedure.....	30
7.7. Test Results.....	30
<b>8. RF FIELD STRENGTH SUSCEPTIBILITY TEST.....</b>	<b>32</b>
8.1. Block Diagram of Test.....	32
8.2. Test Standard.....	32
8.3. Severity Levels and Performance Criterion.....	32
8.4. EUT Configuration on Test.....	33
8.5. Operating Condition of EUT.....	33
8.6. Test Procedure.....	33
8.7. Test Results.....	33
<b>9. ELECTRICAL FAST TRANSIENT/BURST IMMUNITY TEST.....</b>	<b>35</b>
9.1. Block Diagram of Test Setup.....	35

9.2. Test Standard.....	35
9.3. Severity Levels and Performance Criterion.....	35
9.4. EUT Configuration.....	36
9.5. Operating Condition of EUT.....	36
9.6. Test Procedure.....	36
9.7. Test Result.....	36
<b>10. SURGE IMMUNITY TEST.....</b>	<b>38</b>
10.1. Block Diagram of Test Setup.....	38
10.2. Test Standard.....	38
10.3. Severity Levels and Performance Criterion.....	38
10.4. EUT Configuration.....	39
10.5. Operating Condition of EUT.....	39
10.6. Test Procedure.....	39
10.7. Test Result.....	39
<b>11. INJECTED CURRENTS SUSCEPTIBILITY TEST.....</b>	<b>41</b>
11.1. Block Diagram of Test Setup.....	41
11.2. Test Standard.....	41
11.3. Severity Levels and Performance Criterion.....	41
11.4. EUT Configuration.....	42
11.5. Operating Condition of EUT.....	42
11.6. Test Procedure.....	42
11.7. Test Results.....	42
<b>12. MAGNETIC FIELD SUSCEPTIBILITY TEST.....</b>	<b>44</b>
12.1. Block Diagram of Test.....	44
12.2. Test Standard.....	44
12.3. Severity Levels and Performance Criterion.....	44
12.4. EUT Configuration on Test.....	45
12.5. Test Procedure.....	45
12.6. Test Results.....	45
<b>13. VOLTAGE DIPS AND INTERRUPTIONS TEST.....</b>	<b>47</b>
13.1. Block Diagram of Test Setup.....	47
13.2. Test Standard.....	47
13.3. Severity Levels and Performance Criterion.....	47
13.4. EUT Configuration.....	48
13.5. Operating Condition of EUT.....	48
13.6. Test Procedure.....	48
13.7. Test Result.....	48
<b>14. TEST PHOTOGRAPH.....</b>	<b>50</b>
14.1. Photos of Conducted Emission Measurement.....	50
14.2. Photo of Radiation Emission Measurement.....	51
14.3. Photo of Electrostatic Discharge Test.....	51
14.4. Photo of RF Field Strength susceptibility Test.....	52
14.5. Photos of Electrical Fast Transient/Burst Test.....	52
14.6. Photo of Surge Test.....	53
14.7. Photo of Injected Currents Susceptibility Test.....	53
14.8. Photo of Magnetic Field Immunity Test.....	54
14.9. Photo of Voltage dips and interruption Test.....	54

APPENDIX (Photos of EUT) (2 Pages)

## TEST REPORT VERIFICATION

Applicant : INVT POWER SYSTEM (SHENZHEN) CO., LTD.  
Manufacturer : INVT POWER SYSTEM (SHENZHEN) CO., LTD.  
Trademark : INVT  
EUT : Uninterruptible Power Systems  
Model Number : RM600/30X, RM500/25X, RM400/20X  
Power Supply : Please refer to page 8

### Measurement Procedure Used:

EN62040-2: 2006,  
(IEC 61000-4-2:2008, IEC 61000-4-3:2006+A1:2007+A2:2010, IEC 61000-4-4:2012,  
IEC 61000-4-5:2014, IEC 61000-4-6:2013, IEC 61000-4-8:2009, IEC 61000-4-11:2004)

The device described above is tested by EMTEK(SHENZHEN) CO., LTD. to determine the maximum emission levels emanating from the device and the severe levels of the device can endure and its performance criterion. The measurement results are contained in this test report and EMTEK(SHENZHEN) CO., LTD. is assumed full of responsibility for the accuracy and completeness of these measurements. Also, this report shows that the EUT (Equipment Under Test) is technically compliant with the EN 62040-2 requirements.

In this report the model and configuration chosen for each test is representative for all models or configurations (defined in the user manual) by using The "Worst Case" approach of the Guide for the EMC Directive 2004/108/EC (8th February 2010).

This report applies to above tested sample only and shall not be reproduced in part without written approval of EMTEK(SHENZHEN) CO., LTD.

Date of Test : April 24, 2015 to June 02, 2015

Prepared by :   
Bunny Zhang/Editor

Reviewer :   
Jessie Hu/Supervisor

Approved & Authorized Signer :   
Lisa Wang/Manager



## Modified Information

Version	Report No.	Revision Date	Summary
Ver.1.0	ES150423306E	/	Original Report
Ver.1.0	ES160523059E	May 24, 2016	Update EMC directive and standards

## 1. SUMMARY OF TEST RESULT

<b>EMISSION</b>			
Description of test item	Standard	Limits	Results
Conducted disturbance at mains terminals	EN62040-2: 2006	C3	Pass
Radiated Disturbance	EN62040-2: 2006	C3	Pass
<b>Immunity</b>			
Description of test item	Basic Standard	Performance Criteria	Results
Electrostatic Discharge (ESD)	IEC 61000-4-2:2008	B	Pass
Radio-frequency, Continuous radiated disturbance	IEC 61000-4-3:2006+A1:2007+A2:2010	A	Pass
EFT/B Immunity	IEC 61000-4-4:2012	B	Pass
Surge Immunity	IEC 61000-4-5:2014	B	Pass
Conducted RF Immunity	IEC 61000-4-6:2013	A	Pass
Power frequency magnetic field	IEC 61000-4-8:2009	A	Pass
Voltage dips and Voltage interruptions	IEC 61000-4-11:2004	B	Pass
Note: /			

## 2. GENERAL INFORMATION

### 2.1. Description of Device (EUT)

EUT	:	Uninterruptible Power Systems
Model Number	:	RM600/30X, RM500/25X, RM400/20X (Note: These models are identical in circuitry and electrical, mechanical and physical construction; the only differences are the output rating and model number. for trading purpose. We prepare RM600/30X for test.)
Input Rating	:	RM600/30X: AC Input : 380/400/415VAC, 3 $\phi$ +N+PE, 50Hz/60Hz, 864Amax, Batt Input: $\pm$ 240Vdc, 1200Amax  RM500/25X: AC Input : 380/400/415VAC, 3 $\phi$ +N+PE, 50Hz/60Hz, 720Amax, Batt Input: $\pm$ 240Vdc, 1000Amax  RM400/20X: AC Input : 380/400/415VAC, 3 $\phi$ +N+PE, 50Hz/60Hz, 576Amax, Batt Input: $\pm$ 240Vdc, 800Amax
Output Rating	:	RM600/30X: 380/400/415VAC, 3 $\phi$ +N+PE, 50Hz/60Hz, 600kVA/540kW  RM500/25X: 380/400/415VAC, 3 $\phi$ +N+PE, 50Hz/60Hz, 500kVA/450kW  RM400/20X: 380/400/415VAC, 3 $\phi$ +N+PE, 50Hz/60Hz, 400kVA/360kW
Test voltage	:	AC 380V/50Hz
Applicant	:	INVT POWER SYSTEM (SHENZHEN) CO., LTD.
Address	:	5 <sup>th</sup> Floor, 1# Building, Gaofa Industrial Park, Longjing, Nanshan District, Shenzhen, China, 518055
Manufacturer	:	INVT POWER SYSTEM (SHENZHEN) CO., LTD.
Address	:	5 <sup>th</sup> Floor, 1# Building, Gaofa Industrial Park, Longjing, Nanshan District, Shenzhen, China, 518055
Date of receiver	:	April 24, 2015
Date of Test	:	April 24, 2015 to June 02, 2015

## 2.2. Description of Support Device

N/A

## 2.3. Description of Test Facility

### Site Description

EMC Lab. : Accredited by CNAS, 2013.10.29  
The certificate is valid until 2016.10.28  
The Laboratory has been assessed and proved to be in compliance with CNAS-CL01: 2006 (identical to ISO/IEC17025: 2005)  
The Certificate Registration Number is L2291.

Accredited by TUV Rheinland Guangzhou 2010.5.25  
The Laboratory has been assessed according to the requirements ISO/IEC 17025

Accredited by FCC, April 17, 2013  
The Certificate Registration Number. is 709623.

Accredited by Industry Canada, November 15, 2010  
The Certificate Registration Number. is 46405-4480

Name of Firm : EMTEK(SHENZHEN) CO., LTD  
Site Location : Bldg 69, Majialong Industry Zone,  
Nanshan District, Shenzhen, Guangdong, China

## 2.4. Measurement Uncertainty

Test Item	Uncertainty
Conducted Emission Uncertainty	: 3.16dB(9k~150kHz Conduction 2#) 2.90dB(150k-30MHz Conduction 2#)
Radiated Emission Uncertainty (10m Chamber)	: 3.96dB (30M~1GHz Polarize: H) 4.04dB (30M~1GHz Polarize: V)
Uncertainty for C/S Test	: 1.45(Using CDN Test)
Uncertainty for R/S Test	: 2.10dB(80MHz-200MHz) 1.76dB(200MHz-1000MHz)
Uncertainty for test site temperature and humidity	: 0.6°C 4%



### 3. MEASURING DEVICE AND TEST EQUIPMENT

#### 3.1. For Conducted Emission Measurement

Used	Equipment	Manufacturer	Model No.	Serial No.	Last Cal.	Cal. Interval
<input checked="" type="checkbox"/>	Test Receiver	Rohde & Schwarz	ESCS30	828985/018	May 16, 2015	1 Year
<input checked="" type="checkbox"/>	L.I.S.N.	Schwarzbeck	NNLK8129	8129-203	May 16, 2015	1 Year
<input type="checkbox"/>	L.I.S.N.	ROHDE & SCHWARZ	ESH3-Z6	100011	May 16, 2015	1 Year
<input type="checkbox"/>	L.I.S.N.	ROHDE & SCHWARZ	ESH3-Z6	100253	May 16, 2015	1 Year
<input type="checkbox"/>	L.I.S.N.	ROHDE & SCHWARZ	ESH3-Z5	100191	May 16, 2015	1 Year
<input checked="" type="checkbox"/>	50Ω Coaxial Switch	Anritsu	MP59B	M20531	N/A	N/A
<input checked="" type="checkbox"/>	Pulse Limiter	Rohde & Schwarz	ESH3-Z2	100006	May 16, 2015	1 Year
<input type="checkbox"/>	Current probe	Rohde & Schwarz	EZ-17	0816.2063.02	May 16, 2015	1 Year

#### 3.2. For Radiated Emission Measurement

Used	Equipment	Manufacturer	Model No.	Serial No.	Last Cal.	Cal. Interval
<input checked="" type="checkbox"/>	EMI TEST RECEIVER	R&S/DE	ESR3	1316.300K03-1017 07-Z1 1316.3003K03-101 706-HN	May 16, 2015	1Year
<input type="checkbox"/>	EMI TEST RECEIVER	R&S/DE	ESCI3	1166.5950K03-101 384-Bw	May 16, 2015	1Year
<input type="checkbox"/>	Frequency Analyser	R&S/DE	FSV40	132.1.3008K39-10 0967-AP	May 16, 2015	1Year
<input checked="" type="checkbox"/>	Broadband Antenna(30M-3GHz)	Schwarzbeck/DE	VULP9163	659/660/661	May 16, 2015	1Year
<input type="checkbox"/>	Horn Antenna(1G-18GHz)	Schwarzbeck/DE	BBHA9120D	1177/1178	May 16, 2015	1Year
<input type="checkbox"/>	Horn Antenna (15G-26.5GHz)	Schwarzbeck/DE	BBHA9170	547	May 16, 2015	1Year
<input type="checkbox"/>	Horn Antenna (26.5G-40GHz)	AHS/USA	SAS-573	184/185	May 16, 2015	1Year
<input checked="" type="checkbox"/>	Pre-Amplifier (10M-1GHz 40dB)	Lunar EM	PM01-1-40	N/A	May 16, 2015	1Year
<input type="checkbox"/>	Pre-Amplifier (1G-18GHz 40dB)	Lunar EM	PM1-18-40	J101121229001	May 16, 2015	1Year
<input type="checkbox"/>	Pre-Amplifier (1G-18GHz 48dB)	Lunar EM	PM1-18-48	DS131115120D11 77	May 16, 2015	1Year
<input type="checkbox"/>	Pre-Amplifier (18G-26.5GHz 40dB)	Lunar EM	PM18-26-40	J1012131010001	May 16, 2015	1Year
<input type="checkbox"/>	Pre-Amplifier (18G-26.5GHz 48dB)	Lunar EM	PM18-26-48	J1013131010001	May 16, 2015	1Year
<input type="checkbox"/>	Pre-Amplifier (26.5G-40GHz 40dB)	Lunar EM	PM26-40-40	J1013131028001	May 16, 2015	1Year

### 3.3. For Electrostatic Discharge Immunity Test

Used	Equipment	Manufacturer	Model No.	Serial No.	Last Cal.	Cal. Interval
<input checked="" type="checkbox"/>	ESD Tester	TESEQ AG	NSG 438A	130	May 16, 2015	1 Year
<input checked="" type="checkbox"/>	Impulse Module	TESEQ AG	INA 4380-150pF/330Ohm	403-550/1712	May 16, 2015	1 Year

### 3.4. For RF Strength Susceptibility Test

Used	Equipment	Manufacturer	Model No.	Serial No.	Last Cal.	Cal. Interval
<input checked="" type="checkbox"/>	Signal Generator	Agilent	N5181A	MY50145187	May 16, 2015	1 Year
<input checked="" type="checkbox"/>	RF Power Meter. Dual Channel	BOONTON	4232A	10539	May 16, 2015	1 Year
<input checked="" type="checkbox"/>	50ohm Diode Power Sensor	BOONTON	51011EMC	34236/34238	May 16, 2015	1 Year
<input checked="" type="checkbox"/>	Field Strength Meter	DARE	RSS1006A	10100037SO 22	May 16, 2015	1 Year
<input checked="" type="checkbox"/>	50ohm Diode Power Sensor	BOONTON	51011EMC	36164	May 16, 2015	1 Year
<input checked="" type="checkbox"/>	Power Amplifier	MILMEGA	80RF1000-175	1059345	May 16, 2015	1 Year
<input type="checkbox"/>	Power Amplifier	MILMEGA	AS0102-55	1018770	May 16, 2015	1 Year
<input checked="" type="checkbox"/>	Power Amplifier	MILMEGA	AS1860-50	1059346	May 16, 2015	1 Year
<input checked="" type="checkbox"/>	Log.-Per. Antenna	SCHWARZBECK	VULP 9118E	N/A	May 16, 2015	1 Year
<input type="checkbox"/>	Broad-Band Horn Antenna	SCHWARZBECK	STLP 9149	9149-227	May 16, 2015	1 Year
<input checked="" type="checkbox"/>	Multi-function interface system	DARE	CTR1009B	12I00250SN O72	N/A	N/A
<input checked="" type="checkbox"/>	Automatic switch group	DARE	RSW1004A	N/A	N/A	N/A

### 3.5. For Electrical Fast Transient/Burst Immunity Test

Used	Equipment	Manufacturer	Model No.	Serial No.	Last Cal.	Cal. Interval
<input checked="" type="checkbox"/>	Burst Tester	HAEFELY	PEFT4010	080981-16	May 16, 2015	1Year
<input type="checkbox"/>	Coupling Clamp	HAEFELY	IP-4A	147147	May 16, 2015	1Year
<input checked="" type="checkbox"/>	Three phase CDN	Teseq	CDN 163	202	May 16, 2015	1 Year

### 3.6. For Surge Immunity Test

Used	Equipment	Manufacturer	Model No.	Serial No.	Last Cal.	Cal. Interval
<input checked="" type="checkbox"/>	Surge Controller	HAEFELY	Psurge 8000	174031	May 16, 2015	1Year
<input checked="" type="checkbox"/>	Impulse Module	HAEFELY	PIM 100	174124	May 16, 2015	1Year
<input checked="" type="checkbox"/>	Coupling Decoupling Filter	HAEFELY	PCD 130	172181	May 16, 2015	1Year
<input type="checkbox"/>	Coupling Module	HAEFELY	PCD122	174354	May 16, 2015	1Year
<input type="checkbox"/>	Surge Impulse Module	HAEFELY	PIM 120	174435	May 16, 2015	1Year
<input type="checkbox"/>	Coupling Module	HAEFELY	PCD 126A	174387	May 16, 2015	1Year
<input type="checkbox"/>	Impulse Module	HAEFELY	PIM 110	174391	May 16, 2015	1Year
<input type="checkbox"/>	Impulse Module	HAEFELY	PIM 150	178707	May 16, 2015	1Year

### 3.7. For Injected Current Susceptibility Test

Used	Equipment	Manufacturer	Model No.	Serial No.	Last Cal.	Cal. Interval
<input checked="" type="checkbox"/>	Simulator	FRANKONIA	CIT-10	126B1210120 12	May 16, 2015	1Year
<input type="checkbox"/>	CDN	EMTEST	CDN-M2	5100100100	May 16, 2015	1Year
<input checked="" type="checkbox"/>	CDN	EMTEST	CDN-M3	0900-11	May 16, 2015	1Year
<input type="checkbox"/>	Injection Clamp	EMTEST	F-2031-23MM	368	May 16, 2015	1Year
<input checked="" type="checkbox"/>	Attenuator	EMTEST	ATT6	0010222A	May 16, 2015	1Year
<input type="checkbox"/>	Three phase CDN	Teseq	CDN M332S	32655	May 16, 2015	1 Year
<input type="checkbox"/>	Three phase CDN	Teseq	CDN M432S	33670	May 16, 2015	1 Year
<input type="checkbox"/>	Three phase CDN	Teseq	CDN M432-3LNS	34048	May 16, 2015	1 Year
<input checked="" type="checkbox"/>	Three phase CDN	Teseq	CDN M532S	33799	May 16, 2015	1 Year

### 3.8. For Magnetic Field Immunity Test

Used	Equipment	Manufacturer	Model No.	Serial No.	Last Cal.	Cal. Interval
<input checked="" type="checkbox"/>	Magnetic Field Tester	HAEFELY	MAG100	250040.1	May 16, 2015	1Year

### 3.9. For Voltage Dips and Interruptions Test

Used	Equipment	Manufacturer	Model No.	Serial No.	Last Cal.	Cal. Interval
<input checked="" type="checkbox"/>	45KVA AC Power source	Teseq/Germany	NSG 1007-45/45KVA	1305A02873	May 16, 2015	1 Year
<input type="checkbox"/>	Signal conditioning Unit	Teseq/Germany	CCN 1000-3	1305A02873	May 16, 2015	1 Year
<input type="checkbox"/>	Three phase impedance network	Teseq/Germany	INA2197/37A	1305A02873	May 16, 2015	1 Year
<input type="checkbox"/>	Three phase impedance network	Teseq/Germany	INA 2196/75A	1305A02874	May 16, 2015	1 Year
<input checked="" type="checkbox"/>	Proflin 2100 AC Switching Unit	Teseq/Germany	NSG2200-3	A22714	May 16, 2015	1 Year

## 4. CONDUCTED EMISSION MEASUREMENT

### 4.1. Block Diagram of Test Setup

For AC Mains:

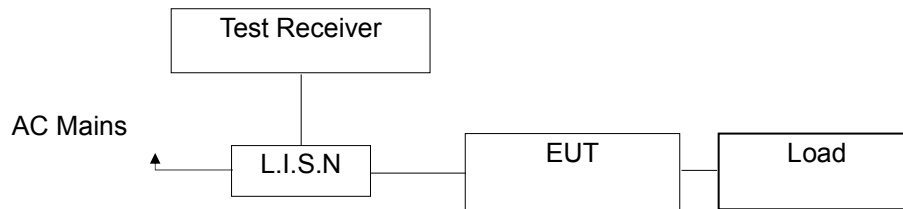

(EUT: Uninterruptible Power Systems)

### 4.2. Measuring Standard

EN62040-2: 2006, Category C3

### 4.3. Power Line Conducted Emission Limits (C3)

UPS rated output current A	Frequency range MHz	Limits dB (μV)	
		Quasi-peak	Average
>16 – 100	0,15 to 0,50 <sup>b</sup>	100	90
	0,50 to 5,0 <sup>b</sup>	86	76
	5,0 to 30,0	90 to 70 <sup>a</sup>	80 to 60 <sup>a</sup>
>100	0,15 to 0,50 <sup>b</sup>	130	120
	0,50 to 5,0 <sup>b</sup>	125	115
	5,0 to 30,0	115	105

<sup>a</sup> The limits decrease linearly with the logarithm of the frequency.  
<sup>b</sup> The lower limit shall apply at the transition frequency.

### 4.4. EUT Configuration on Measurement

The following equipments are installed on Conducted Emission Measurement to meet EN 62040-2 requirements and operating in a manner which tends to maximize its emission characteristics in a normal application.

Uninterruptible Power Systems (EUT)  
 Model Number : RM600/30X  
 Serial Number : N/A

#### 4.5. Operating Condition of EUT

4.5.1. Setup the EUT as shown on Section 4.1.

4.5.2. Turn on the power of all equipments.

4.5.3. Let the EUT work in measuring mode (Line mode, Battery mode) and measure it.

#### 4.6. Test Procedure

The EUT is put on the ground by insulating support and connected to the AC mains through Line Impedance Stability Network (L.I.S.N). This provided a 50ohm coupling impedance for the tested equipments. Both sides of AC line are investigated to find out the maximum conducted emission according to the EN62040-2 regulations during conducted emission measurement.

The bandwidth of the field strength meter (R&S Test Receiver ESCS30) is set at 9kHz in 150kHz~30MHz and 200Hz in 9kHz~150kHz.

The frequency range from 150kHz to 30MHz is investigated.

#### 4.7. Measuring Results

**PASS.**

Please refer to the following pages.

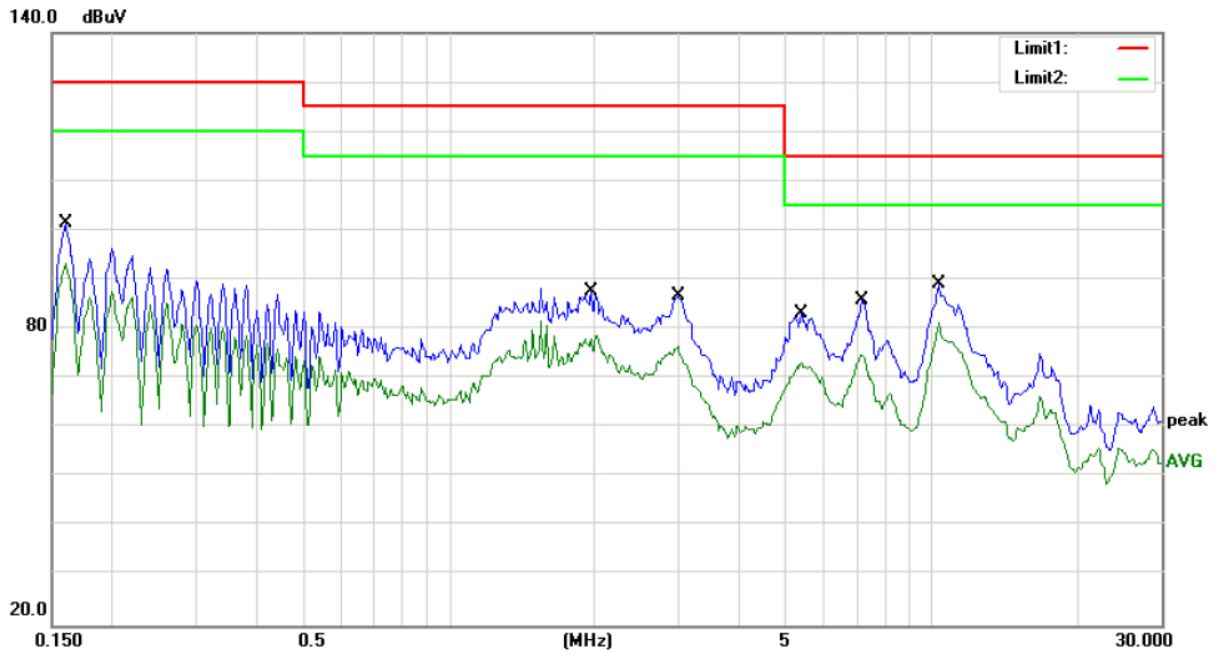

Site Conduction #2

Phase: **L1**

Temperature: 22

Limit: (CE)EN62040-2 C3\_QP(>100A)

Power: AC 380V/50Hz

Humidity: 53 %

Mode: FULL LOAD

Note: LINE MODE

No. Mk.	Freq. MHz	Reading Level dBuV	Correct Factor dB	Measure- ment dBuV	Limit dBuV	Over dB	Detector	Comment
1	0.1600	101.47	0.00	101.47	130.00	-28.53	QP	
2	0.1600	93.44	0.00	93.44	120.00	-26.56	AVG	
3	1.9700	87.66	0.00	87.66	125.00	-37.34	QP	
4	1.9700	78.78	0.00	78.78	115.00	-36.22	AVG	
5	2.9800	86.71	0.00	86.71	125.00	-38.29	QP	
6	2.9800	76.60	0.00	76.60	115.00	-38.40	AVG	
7	5.3700	83.23	0.00	83.23	115.00	-31.77	QP	
8	5.3700	73.33	0.00	73.33	105.00	-31.67	AVG	
9	7.1900	85.81	0.00	85.81	115.00	-29.19	QP	
10	7.1900	74.85	0.00	74.85	105.00	-30.15	AVG	
11	10.3500	89.08	0.00	89.08	115.00	-25.92	QP	
12 *	10.3500	81.29	0.00	81.29	105.00	-23.71	AVG	

\*:Maximum data    x:Over limit    !:over margin    Comment: Factor build in receiver.    Operator: MA

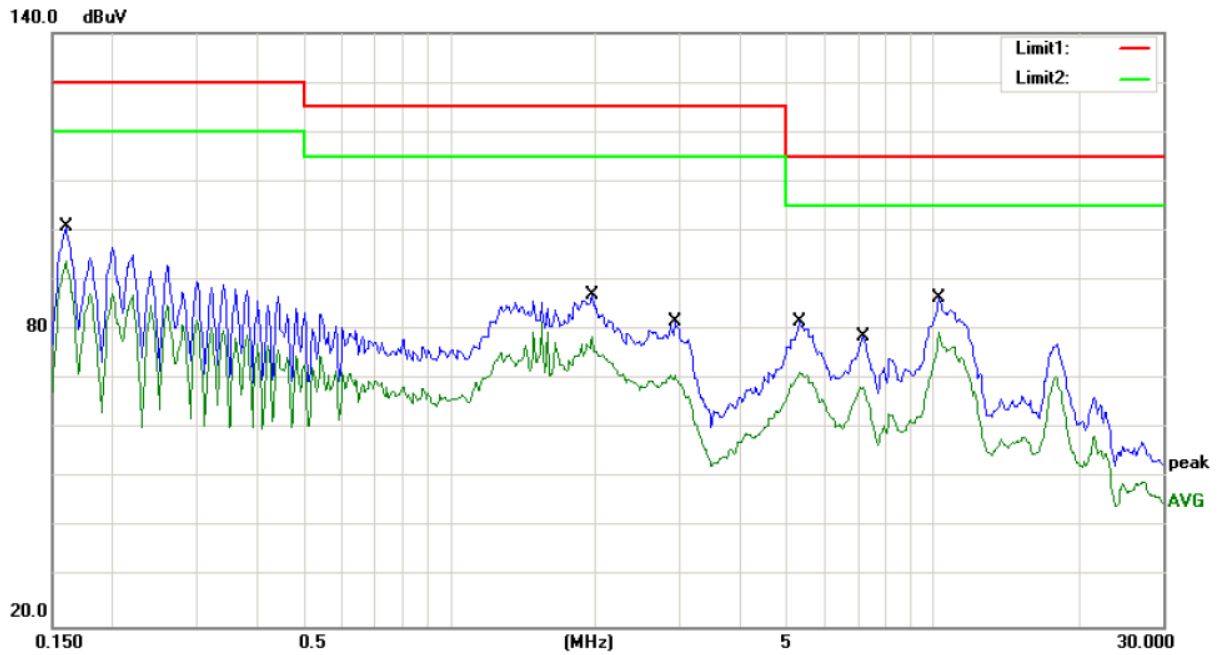

Site Conduction #2 Phase: **L2** Temperature: 22  
 Limit: (CE)EN62040-2 C3\_QP(>100A) Power: AC 380V/50Hz Humidity: 53 %  
 Mode: FULL LOAD  
 Note: LINE MODE

No. Mk.	Freq. MHz	Reading Level dBuV	Correct Factor dB	Measure- ment dBuV	Limit dBuV	Over dB	Detector	Comment
1	0.1600	100.90	0.00	100.90	130.00	-29.10	QP	
2 *	0.1600	93.84	0.00	93.84	120.00	-26.16	AVG	
3	1.9700	87.16	0.00	87.16	125.00	-37.84	QP	
4	1.9700	81.67	0.00	81.67	115.00	-33.33	AVG	
5	2.9200	81.59	0.00	81.59	125.00	-43.41	QP	
6	2.9200	70.80	0.00	70.80	115.00	-44.20	AVG	
7	5.2900	81.52	0.00	81.52	115.00	-33.48	QP	
8	5.2900	71.38	0.00	71.38	105.00	-33.62	AVG	
9	7.1800	78.57	0.00	78.57	115.00	-36.43	QP	
10	7.1800	68.45	0.00	68.45	105.00	-36.55	AVG	
11	10.3000	86.58	0.00	86.58	115.00	-28.42	QP	
12	10.3000	77.19	0.00	77.19	105.00	-27.81	AVG	

\*:Maximum data x:Over limit !:over margin Comment: Factor build in receiver. Operator: MA

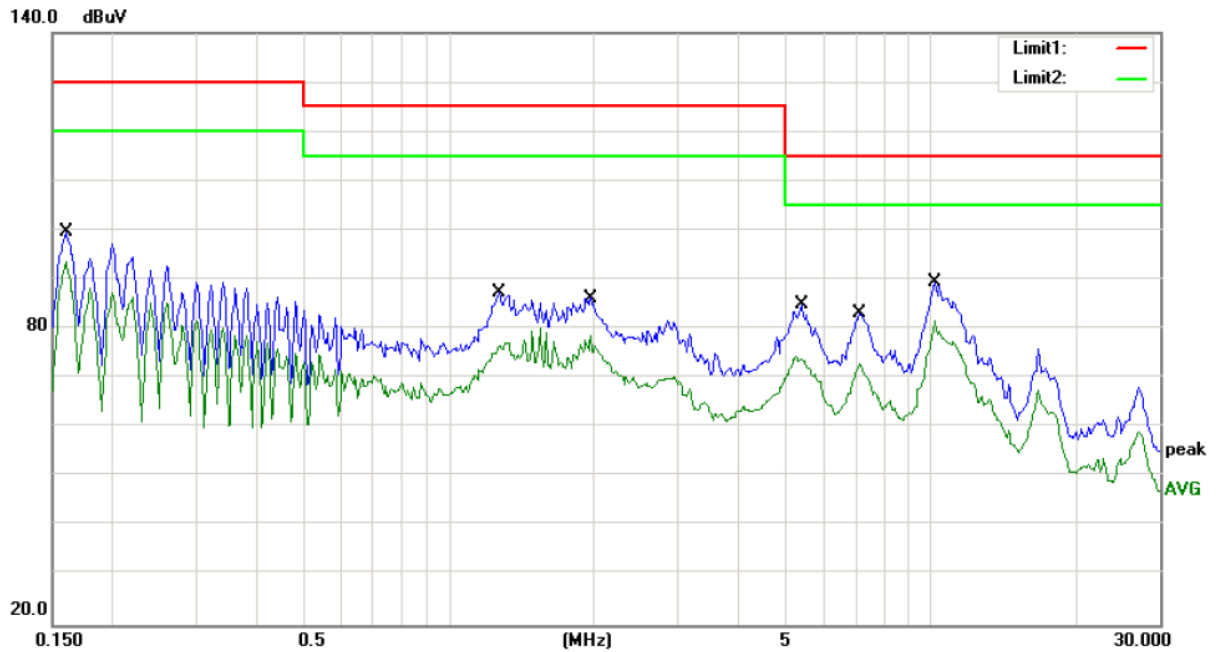

Site Conduction #2 Phase: **L3** Temperature: 22  
 Limit: (CE)EN62040-2 C3\_QP(>100A) Power: AC 380V/50Hz Humidity: 53 %  
 Mode: FULL LOAD  
 Note: LINE MODE

No. Mk.	Freq.	Reading Level	Correct Factor	Measurement	Limit	Over	Detector	Comment
	MHz	dBuV	dB	dBuV	dBuV	dB		
1	0.1600	99.66	0.00	99.66	130.00	-30.34	QP	
2	0.1600	93.64	0.00	93.64	120.00	-26.36	AVG	
3	1.2700	87.30	0.00	87.30	125.00	-37.70	QP	
4	1.2700	77.21	0.00	77.21	115.00	-37.79	AVG	
5	1.9700	86.30	0.00	86.30	125.00	-38.70	QP	
6	1.9700	78.61	0.00	78.61	115.00	-36.39	AVG	
7	5.3900	85.09	0.00	85.09	115.00	-29.91	QP	
8	5.3900	74.33	0.00	74.33	105.00	-30.67	AVG	
9	7.1200	83.28	0.00	83.28	115.00	-31.72	QP	
10	7.1200	73.07	0.00	73.07	105.00	-31.93	AVG	
11	10.2000	89.53	0.00	89.53	115.00	-25.47	QP	
12 *	10.2000	81.52	0.00	81.52	105.00	-23.48	AVG	

\*:Maximum data x:Over limit !:over margin Comment: Factor build in receiver. Operator: MA



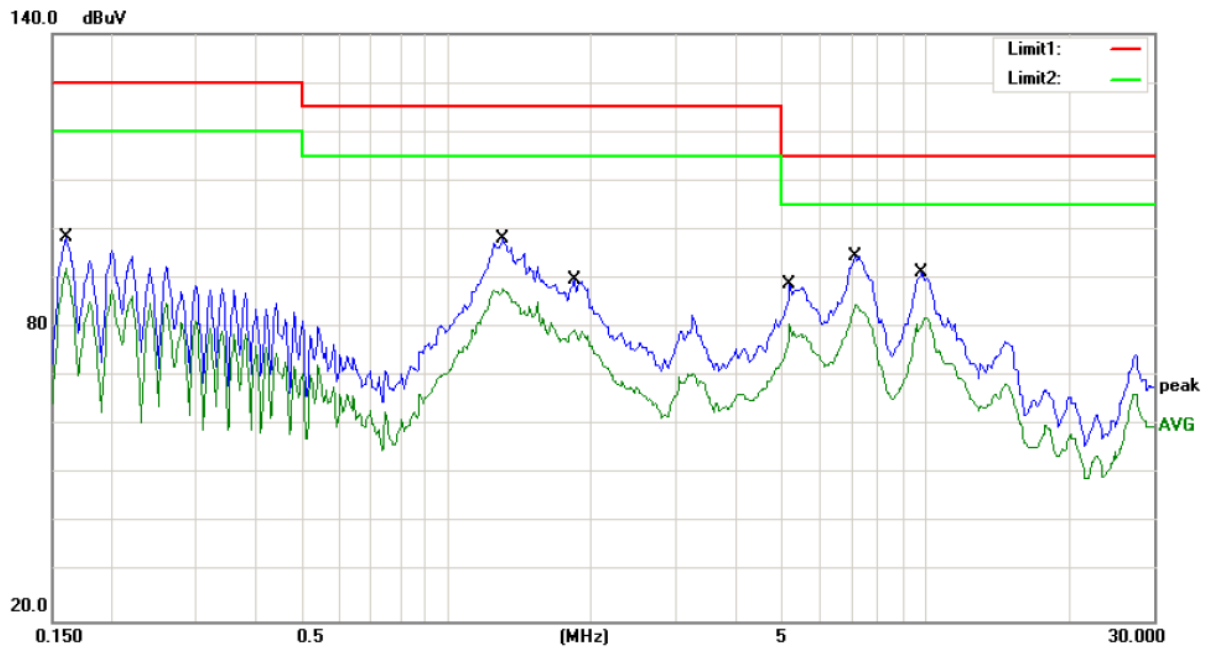

Site Conduction #2

Phase: **N**

Temperature: 22

Limit: (CE)EN62040-2 C3\_QP(>100A)

Power: AC 380V/50Hz

Humidity: 53 %

Mode: FULL LOAD

Note: LINE MODE

No. Mk.	Freq. MHz	Reading Level dBuV	Correct Factor dB	Measure- ment dBuV	Limit dBuV	Over dB	Detector	Comment
1	0.1600	98.47	0.00	98.47	130.00	-31.53	QP	
2	0.1600	91.39	0.00	91.39	120.00	-28.61	AVG	
3	1.3100	98.08	0.00	98.08	125.00	-26.92	QP	
4	1.3100	87.88	0.00	87.88	115.00	-27.12	AVG	
5	1.8500	89.60	0.00	89.60	125.00	-35.40	QP	
6	1.8500	79.55	0.00	79.55	115.00	-35.45	AVG	
7	5.2100	88.97	0.00	88.97	115.00	-26.03	QP	
8	5.2100	80.77	0.00	80.77	105.00	-24.23	AVG	
9 *	7.1200	94.62	0.00	94.62	115.00	-20.38	QP	
10	7.1200	84.54	0.00	84.54	105.00	-20.46	AVG	
11	9.8400	91.36	0.00	91.36	115.00	-23.64	QP	
12	9.8400	80.63	0.00	80.63	105.00	-24.37	AVG	

\*:Maximum data    x:Over limit    !:over margin    Comment: Factor build in receiver.    Operator: MA

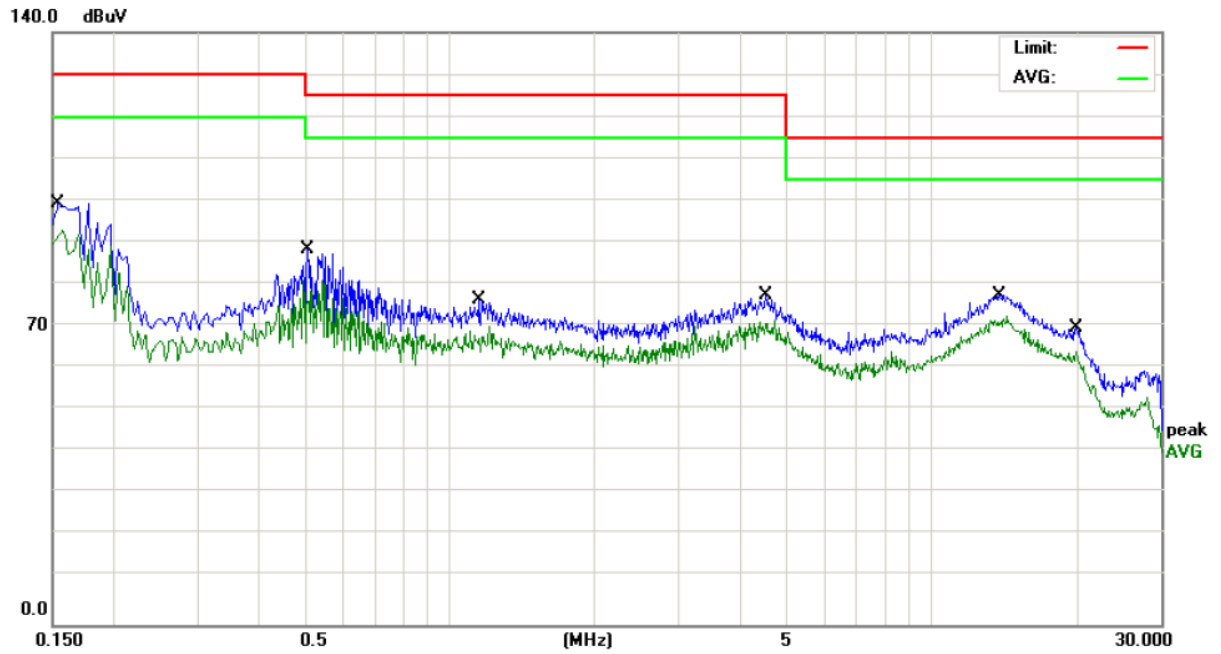

Site Chamber #1 Phase: **L1** Temperature: 22  
 Limit: CE:EN 62040-2 (C3 >100A)\_QP Power: DC 480V Humidity: 53 %  
 Mode: FULL LOAD  
 Note: BATTERY MODE

No. Mk.	Freq.	Reading Level	Correct Factor	Measurement	Limit	Over	Detector	Comment
	MHz	dBuV	dB	dBuV	dBuV	dB		
1	0.1540	77.96	20.00	97.96	130.0	-32.04	QP	
2 *	0.1540	71.23	20.00	91.23	120.0	-28.77	AVG	
3	0.5100	63.47	20.00	83.47	125.0	-41.53	QP	
4	0.5100	52.05	20.00	72.05	115.0	-42.95	AVG	
5	1.1580	51.60	20.00	71.60	125.0	-53.40	QP	
6	1.1580	45.39	20.00	65.39	115.0	-49.61	AVG	
7	4.5260	54.16	20.00	74.16	125.0	-50.84	QP	
8	4.5260	46.62	20.00	66.62	115.0	-48.38	AVG	
9	13.8540	53.62	20.00	73.62	115.0	-41.38	QP	
10	13.8540	49.13	20.00	69.13	105.0	-35.87	AVG	
11	19.9500	44.35	20.00	64.35	115.0	-50.65	QP	
12	19.9500	39.06	20.00	59.06	105.0	-45.94	AVG	

\*:Maximum data x:Over limit !:over margin

(Reference Only)

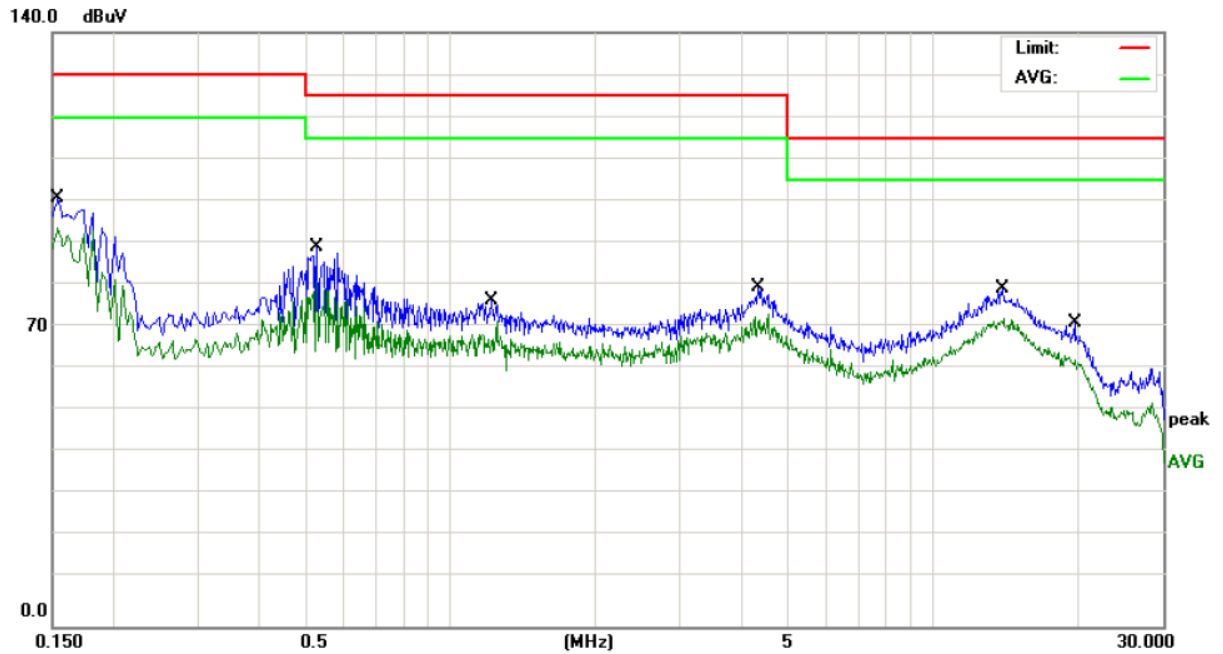

Site Chamber #1 Phase: **L2** Temperature: 22  
 Limit: CE:EN 62040-2 (C3 >100A)\_QP Power: DC 480V Humidity: 53 %  
 Mode: FULL LOAD  
 Note: BATTERY MODE

No.	Mk.	Freq.	Reading Level	Correct Factor	Measurement	Limit	Over	Detector	Comment
		MHz	dBuV	dB	dBuV	dBuV	dB		
1		0.1540	77.96	20.00	97.96	130.0	-32.04	QP	
2	*	0.1540	70.91	20.00	90.91	120.0	-29.09	AVG	
3		0.5300	63.00	20.00	83.00	125.0	-42.00	QP	
4		0.5300	52.90	20.00	72.90	115.0	-42.10	AVG	
5		1.2180	50.94	20.00	70.94	125.0	-54.06	QP	
6		1.2180	44.85	20.00	64.85	115.0	-50.15	AVG	
7		4.3540	53.85	20.00	73.85	125.0	-51.15	QP	
8		4.3540	46.08	20.00	66.08	115.0	-48.92	AVG	
9		13.9540	53.77	20.00	73.77	115.0	-41.23	QP	
10		13.9540	49.01	20.00	69.01	105.0	-35.99	AVG	
11		19.7260	44.14	20.00	64.14	115.0	-50.86	QP	
12		19.7260	38.77	20.00	58.77	105.0	-46.23	AVG	

\*:Maximum data    x:Over limit    !:over margin

⟨Reference Only



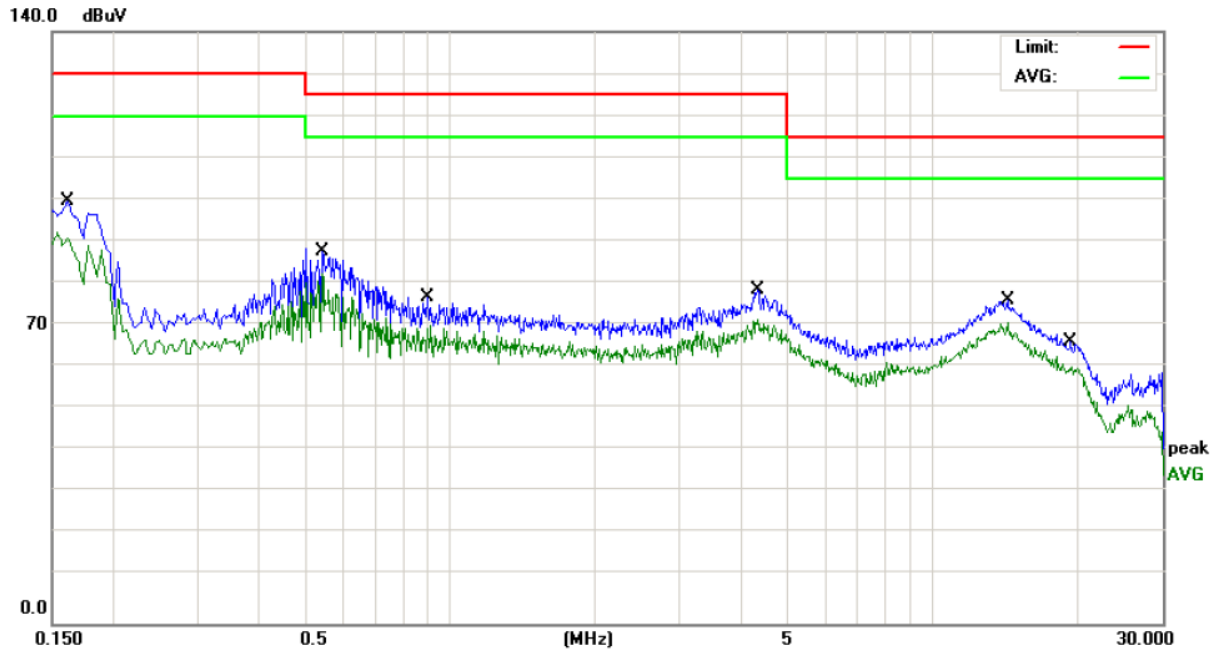

Site Chamber #1 Phase: **N** Temperature: 22  
 Limit: CE:EN 62040-2 (C3 >100A)\_QP Power: DC 480V Humidity: 53 %  
 Mode: FULL LOAD  
 Note: BATTERY MODE

No. Mk.	Freq. MHz	Reading Level dBuV	Correct Factor dB	Measure- ment dBuV	Limit dBuV	Over dB	Detector	Comment
1	0.1620	75.13	20.00	95.13	130.0	-34.87	QP	
2	0.1620	67.78	20.00	87.78	120.0	-32.22	AVG	
3	0.5460	64.65	20.00	84.65	125.0	-40.35	QP	
4	0.5460	54.61	20.00	74.61	115.0	-40.39	AVG	
5	0.9020	52.00	20.00	72.00	125.0	-53.00	QP	
6	0.9020	45.30	20.00	65.30	115.0	-49.70	AVG	
7	4.3540	53.08	20.00	73.08	125.0	-51.92	QP	
8	4.3540	46.12	20.00	66.12	115.0	-48.88	AVG	
9	14.3300	51.65	20.00	71.65	115.0	-43.35	QP	
10	14.3300	46.86	20.00	66.86	105.0	-38.14	AVG	
11	19.3980	41.29	20.00	61.29	115.0	-53.71	QP	
12	19.3980	36.26	20.00	56.26	105.0	-48.74	AVG	

\*:Maximum data x:Over limit !:over margin

<Reference Only

## 5. RADIATED EMISSION MEASUREMENT

### 5.1. Block Diagram of Test

#### 5.1.1. Block diagram of connection between the EUT and simulators



(EUT: Uninterruptible Power Systems)

#### 5.1.2. Block diagram of test setup (In chamber)

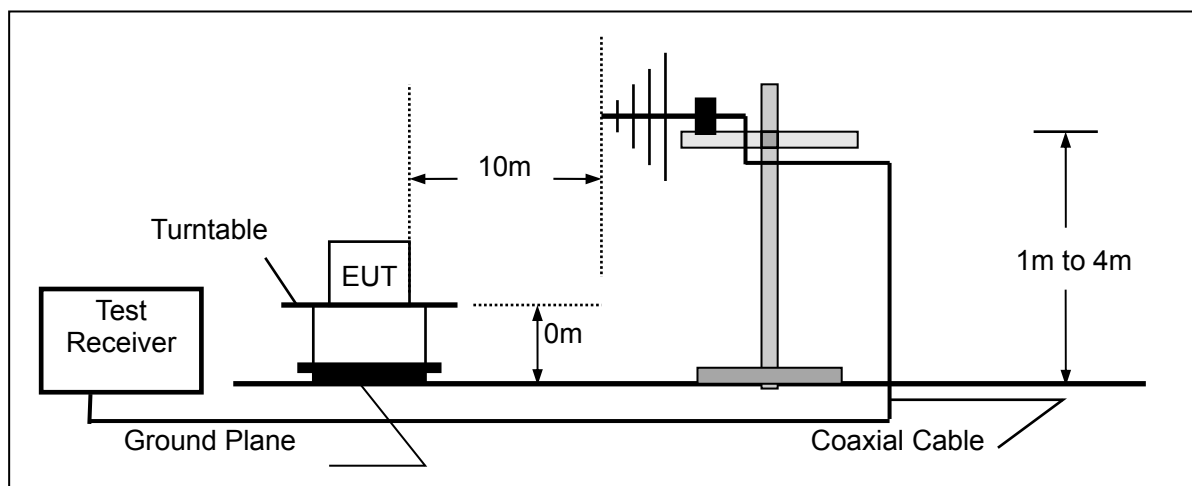

(EUT: Uninterruptible Power Systems)

### 5.2. Measuring Standard

EN62040-2: 2006 Category C3

### 5.3. Radiated Emission Limits(C3)

All emanations from a C3 device or system, including any network of conductors and apparatus connected thereto, shall not exceed the level of field strengths specified below:

FREQUENCY (MHz)	DISTANCE (Meters)	FIELD STRENGTHS LIMIT (dB $\mu$ V/m)
30 ~ 230	10	50
230 ~ 1000	10	57

Note: (1) The smaller limit shall apply at the combination point between two frequency bands.  
(2) Distance refers to the distance in meters between the measuring instrument antenna and the closed point of any part of the EUT.

#### 5.4. EUT Configuration on Test

The EN 62040-2 regulations test method must be used to find the maximum emission during radiated emission measurement.

#### 5.5. Operating Condition of EUT

5.5.1. Turn on the power.

5.5.2. After that, let the EUT work in test mode (Line mode, Battery mode) and measure it.

#### 5.6. Test Procedure

The EUT is placed on a turn table which is 0 meter high above the ground. The turn table can rotate 360 degrees to determine the position of the maximum emission level. The EUT is set 10 meters away from the receiving antenna which is mounted on an antenna tower. The antenna can be moved up and down from 1 to 4 meters to find out the maximum emission level. Bilog antenna (calibrated by Dipole Antenna) is used as a receiving antenna. Both horizontal and vertical polarization of the antenna are set on test.

The bandwidth of the Receiver is set at 120kHz.

#### 5.7. Measuring Results

**PASS.**

The frequency range from 30MHz to 1000MHz is investigated.

# Radiated Emission Measurement

Data: 1

## 1. Settings

Start: 30MHz	Stop: 1GHz	
RBW: 120KHz	VBW: 300KHz	Ref: 100
RFAAtt: 10	PreAmp: False	Polarization: Horizontal
Tester: CSL	Model: RM600/30X	Mode: FULL LOAD
Power:AC 380V/50Hz	Temperature:20	Humidity:53
Note: LINE MODE	Test Distance:10M	EUT:UPS

## 2. Chart

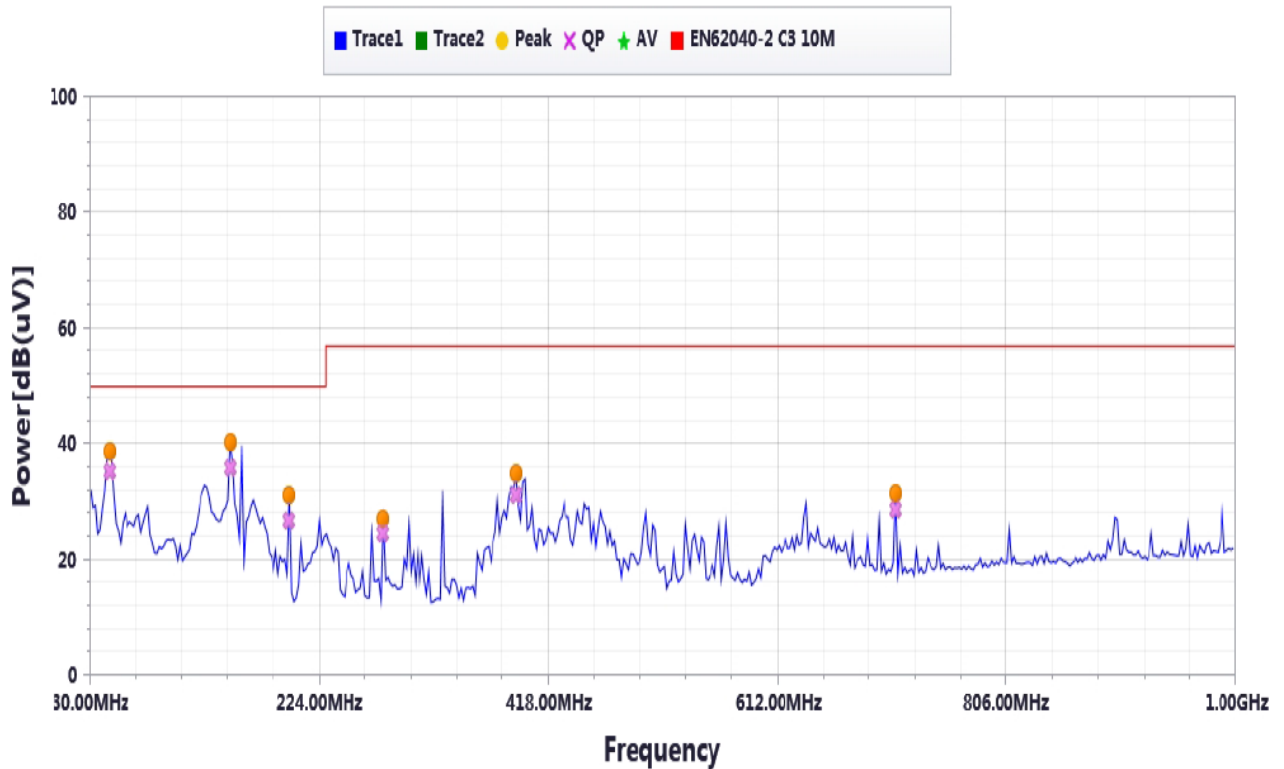

## 3. Result

No	Frequency	QP	Correct factor	Reading level	Limit1	Margin QP	Table Degree	Antenna Height	Result
	MHz	dB (uV)	dB	dB (uV)	dB (uV)	dB	Degree	cm	
1	46.46	35.2	-29.39	68.28	50	-14.8			Pass
2	149.07	36.1	-34.19	74.54	50	-13.9			Pass
3	199.41	26.9	-30.32	61.44	50	-23.1			Pass
4	278.79	24.5	-28.17	55.33	57	-32.5			Pass
5	391.09	31.2	-25.29	60.37	57	-25.8			Pass
6	712.49	28.6	-18.32	49.76	57	-28.4			Pass



# Radiated Emission Measurement

Data: 1

## 1. Settings

Start: 30MHz	Stop: 1GHz	
RBW: 100KHz	VBW: 300KHz	Ref: 100
RFAtt: 10	PreAmp: False	Polarization: Vertical
Tester: CSL	Model: RM600/30X	Mode: FULL LOAD
Power: AC 380V/50Hz	Temperature: 20	Humidity: 53
Note: LINE MODE	Test Distance: 10M	EUT: UPS

## 2. Chart

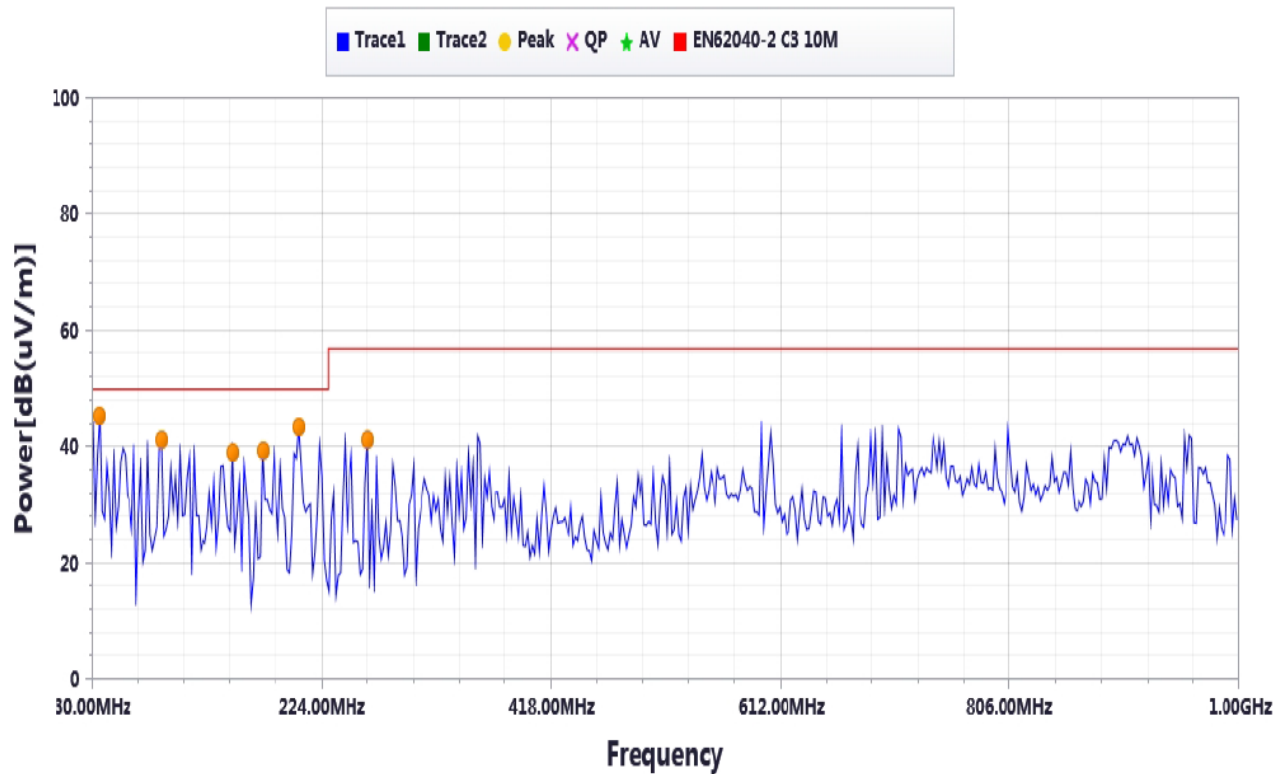

## 3. Result

No	Frequency	QP	Correct factor	Reading level	Limit1	Margin QP	Table Degree	Antenna Height	Result
	MHz	dB (uV/m)	dB	dB (uV)	dB (uV/m)	dB	Degree	cm	
1	36.78	42.1	-31.67	77.1	50	-7.9			Pass
2	89.05	39.2	-33.54	74.9	50	-10.8			Pass
3	149.07	35.1	-35.29	74.56	50	-14.9			Pass
4	174.24	35.4	-33.65	73.03	50	-14.6			Pass
5	205.22	40.1	-31.65	75.18	50	-9.9			Pass
6	263.30	38	-29.53	71.01	57	-19			Pass

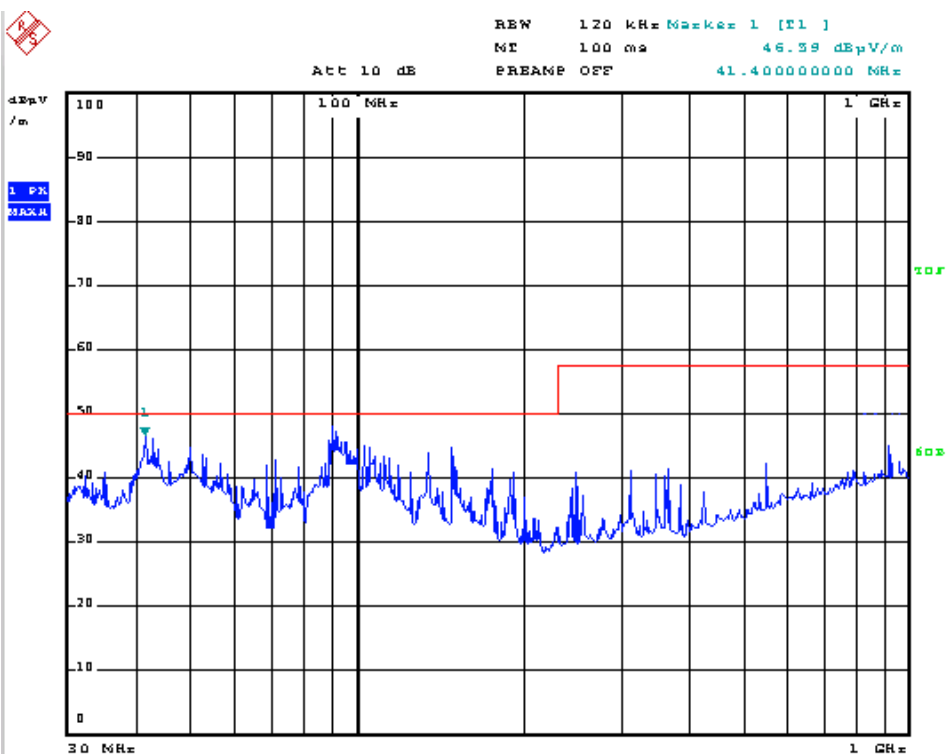
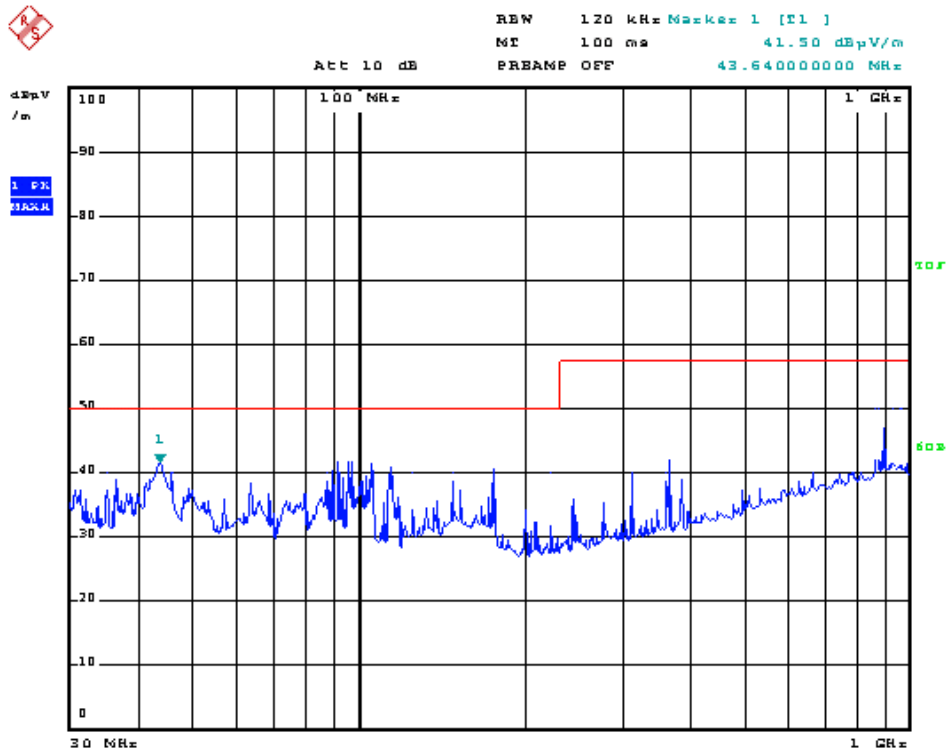

## 6. IMMUNITY PERFORMANCE CRITERIA DESCRIPTION

### Performance Level

The test results shall be classified in terms of the loss of function or degradation of performance of the equipment under test, relative to a performance level by its manufacturer or the requestor of the test, or the agreed between the manufacturer and the purchaser of the product.

Definition related to the performance level:

1. Based on the used product standard
2. Based on the declaration of the manufacturer, requestor or purchaser

#### Criterion A:

Definition: normal performance within limits specified by the manufacturer, requestor and purchaser.

The equipment shall continue to operate as intended without operator intervention. No degradation of performance or loss of function is allowed below a performance level specified by the manufacturer when the equipment is used as intended. The performance level may be replaced by a permissible loss of performance. If the minimum performance level or the permissible performance loss is not specified by the manufacturer, then either of these may be derived from the product description and documentation, and by what the user may reasonably expect from the equipment if used as intended.

#### Criterion B:

Definition: temporary loss of function or degradation of performance which ceases after the disturbance ceases, and from which the equipment under test recovers its normal performance, without operator intervention.

After the test, the EUT shall continue to operate as intended without operator intervention. No degradation of performance or loss of function is allowed, after the application of the phenomena below a performance level specified by the manufacturer, when the EUT is used as intended. The performance level may be replaced by a permissible loss of performance. During the test, degradation of performance is allowed. However, no change of operating state or stored data is allowed to persist after the test. If the minimum performance level (or the permissible performance loss) is not specified by the manufacturer, then either of these may be derived from the product description and documentation, and by what the user may reasonably expect from the EUT if used as intended.

#### Criterion C:

Definition: temporary loss of function or degradation of performance, the correction of which requires operator intervention.

Loss of function is allowed, provided the function is self-recoverable, or can be restored by the operation of the controls by the user in accordance with the manufacturer's instructions. Functions, and/or information stored in non-volatile memory, or protected by a battery backup, shall not be lost.

## Criterion D

Definition: loss of function or degradation of performance, which is not recoverable, owing to damage to hardware or software, or loss of data.

## 7. ELECTROSTATIC DISCHARGE IMMUNITY TEST

### 7.1. Block Diagram of Test Setup

#### 7.1.1. Block diagram of connection between the EUT and simulators

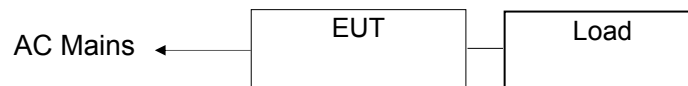

(EUT: Uninterruptible Power Systems)

#### 7.1.2. Block diagram of ESD test setup

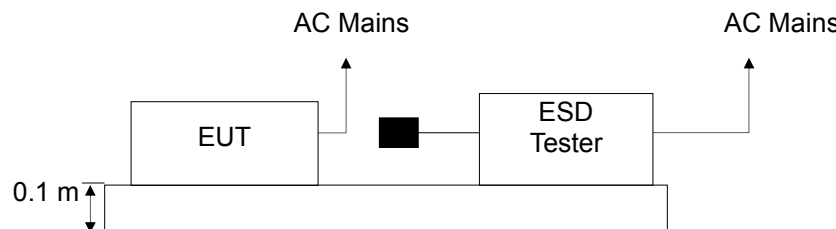

(EUT: Uninterruptible Power Systems)

### 7.2. Test Standard

IEC 61000-4-2:2008 (Air Discharge:  $\pm 8$ kV, Contact Discharge:  $\pm 4$ kV)

### 7.3. Severity Levels and Performance Criterion

#### 7.3.1. Severity level

Level	Test Voltage Contact Discharge (kV)	Test Voltage Air Discharge (kV)
1.	$\pm 2$	$\pm 2$
2.	$\pm 4$	$\pm 4$
3.	$\pm 6$	$\pm 8$
4.	$\pm 8$	$\pm 15$
X	Special	Special

### 7.3.2.Performance criterion : B

	Criterion B
Output characteristics	Voltage permitted to vary within the inverse time characteristics applicable (<100 m sec limits in Figures 1, 2 or 3 of IEC 62040-3)
External and internal indications and metering	Change only during test
Control signals to external devices	Change only temporarily in consistency with the actual Uninterruptible Power Systems mode of operation
Mode of operation	Change only temporarily

### 7.4. EUT Configuration

The configuration of EUT are listed in Section 4.3.

### 7.5. Operating Condition of EUT

Same as conducted emission measurement, which is listed in Section 4.4. except the test set up replaced by Section 7.1.

### 7.6. Test Procedure

#### 7.6.1.Air Discharge:

This test is done on a non-conductive surface. The round discharge tip of the discharge electrode shall be approached as fast as possible to touch the EUT. After each discharge, the discharge electrode shall be removed from the EUT. The generator is then re-triggered for a new single discharge and repeated 10 times for each pre-selected test point. This procedure shall be repeated until all the air discharge completed

#### 7.6.2.Contact Discharge:

All the procedure shall be same as Section 7.6.1. except that the tip of the discharge electrode shall touch the EUT before the discharge switch is operated.

#### 7.6.3.Indirect discharge for horizontal coupling plane

At least 10 single discharges(in the most sensitive polarity) shall be applied at the front edge of each HCP opposite the center point of each unit(if applicable) of the EUT and 0.1m from the front of the EUT. The long axis of the discharge electrode shall be in the plane of the HCP and perpendicular to its front edge during the discharge.

#### 7.6.4.Indirect discharge for vertical coupling plane

At least 10 single discharge (in the most sensitive polarity) shall be applied to the center of one vertical edge of the coupling plane. The coupling plane, of dimensions 0.5m X 0.5m, is placed parallel to, and positioned at a distance of 0.1m from the EUT. Discharges shall be applied to the coupling plane, with this plane in sufficient different positions that the four faces of the EUT are completely illuminated.

### 7.7. Test Results

PASS

Please refer to the following page.

## Electrostatic Discharge Test Result

EMTEK(SHENZHEN) CO., LTD

Applicant : INVT POWER SYSTEM (SHENZHEN) CO., LTD. <hr/> EUT : Uninterruptible Power Systems <hr/> M/N : RM600/30X <hr/> Power Supply : AC 380V/50Hz <hr/> Test Mode : Line mode, Battery mode <hr/> Test Engineer : YU	Test Date : May 25, 2015 <hr/> Temperature : 22°C <hr/> Humidity : 50% <hr/> Actual Criterion : B <hr/> Air discharge : ±8kV <hr/> Contact discharge : ±4kV	
Location	Kind A-Air Discharge C-Contact Discharge	Result
Screen	A	A
Button	A	A
Screw	C	A
Metal	C	A
HCP	C	A
VCP of front	C	A
VCP of rear	C	A
VCP of left	C	A
VCP of right	C	A
Test Equipment: ESD Simulator (TESEQAG, NSG 437)		

## 8. RF FIELD STRENGTH SUSCEPTIBILITY TEST

### 8.1. Block Diagram of Test

#### 8.1.1. Block diagram of connection between the EUT and Load



(EUT: Uninterruptible Power Systems)

#### 8.1.2. Block diagram of RS test setup

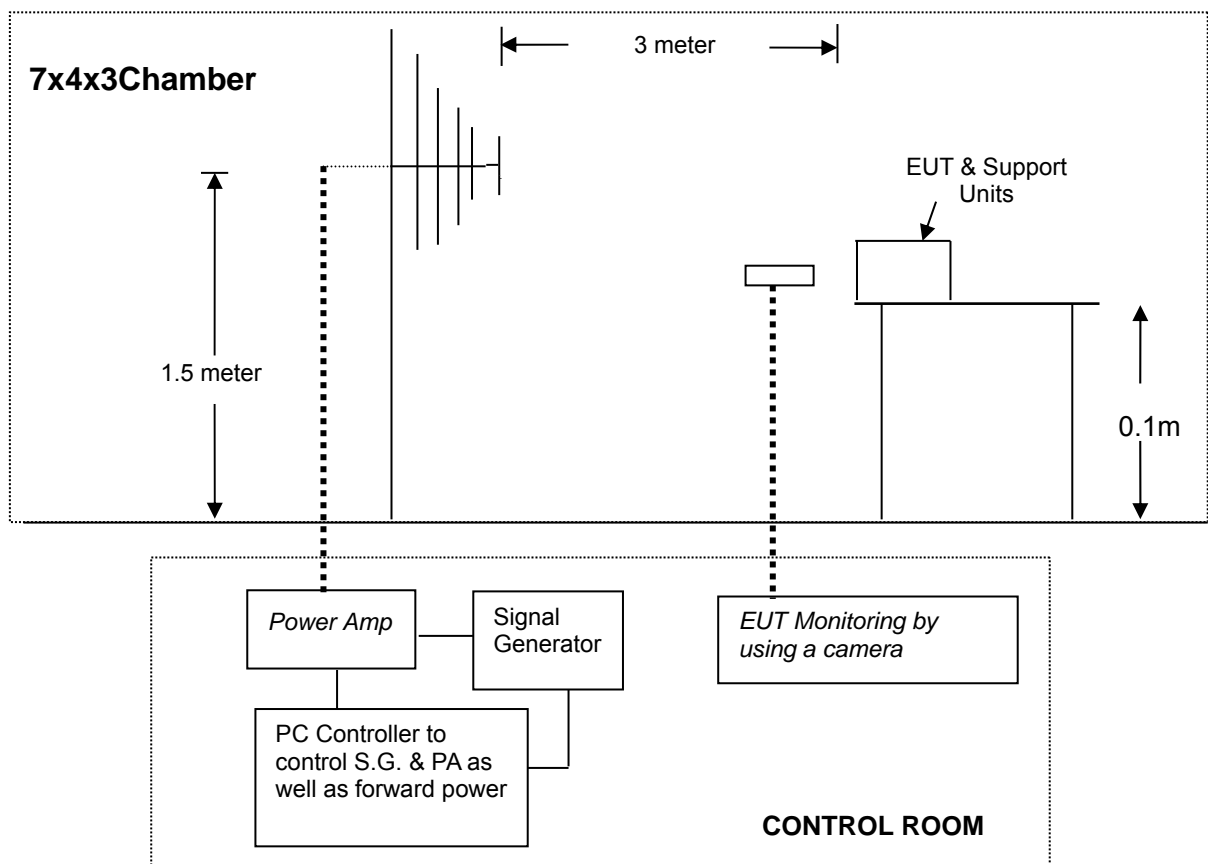

(EUT: Uninterruptible Power Systems)

### 8.2. Test Standard

IEC 61000-4-3:2006+A1:2007+A2:2010 (level 3: 10V / m)

### 8.3. Severity Levels and Performance Criterion

#### 8.3.1. Severity Levels

Level	Field Strength V/m
-------	--------------------



1.	1
2.	3
3.	10
X	Special

8.3.2. Performance Criterion : A

	<b>Criterion A</b>
External and internal indications and metering (LCD)	No change
Output characteristics (Load)	No change
Control signals to external devices (Signal line)	No change
Mode of operation	No change

8.4. EUT Configuration on Test

The configuration of the EUT is same as Section 4.3.

8.5. Operating Condition of EUT

Same as radiated emission measurement which is listed in Section 4.4, except the test setup replaced as Section 8.1.

8.6. Test Procedure

The EUT is placed on a table which is 0.1m high above the ground. The EUT is set 3 meters away from the transmitting antenna which is mounted on an antenna tower. Both horizontal and vertical polarization of the antenna are set on test. Each of the four sides of the EUT must be faced this transmitting antenna and measured individually.

In order to judge the EUT performance, a CCD camera is used to monitor its screen. All the scanning conditions are as following:

Condition of Test	Remark
-----	-----
1. Fielded Strength	10V/m(level 3)
2. Radiated Signal	Modulated
3. Scanning Frequency	80-1000MHz
4. Sweep time of radiated	0.0015 Decade/s
5. Dwell Time	1 Sec.

8.7. Test Results

**PASS.**

Please refer to the following page.

## RF Field Strength Susceptibility Test Results

EMTEK(SHENZHEN) CO., LTD.

<p>Applicant : INVT POWER SYSTEM (SHENZHEN) CO., LTD.</p> <hr/> <p>EUT : Uninterruptible Power Systems</p> <hr/> <p>M/N : RM600/30X</p> <hr/> <p>Field Strength : 10V/m</p> <hr/> <p>Power Supply : AC 380V/50Hz</p> <hr/> <p>Test Engineer : YU</p> <hr/>	<p>Test Date : May 25, 2015</p> <hr/> <p>Temperature : 22°C</p> <hr/> <p>Humidity : 50%</p> <hr/> <p>Actual Criterion : A</p> <hr/> <p>Test Mode : Line mode, Battery mode</p> <hr/> <p>Frequency Range : 80 to 1000 MHz</p> <hr/>		
<p>Modulation: <input type="checkbox"/>None <input type="checkbox"/>Pulse <input checked="" type="checkbox"/>AM 1KHz 80%</p>			
<p>Frequency Rang 1: 80~ 1000MHz</p>			
<p>Frequency Rang 2: N/A</p>			
Steps	# / %	# / %	# / %
	Horizontal	Vertical	Horizontal
Front	A	A	
Right	A	A	
Rear	A	A	
Left	A	A	
<p>Test Equipment :</p> <p>1. Signal Generator : N5181A (Agilent)</p> <p>2. Power Amplifier : 80RF1000-175 (MILMEGA) &amp; AS1860-50 (MILMEGA)</p> <p>3. Log.-Per.Antenna: VULP9118E (SCHWARZBECK)</p> <p>4 RF Power Meter. Dual Channel: 4232A (BOONTON)</p> <p>5 Field Strength Meter: RSS1006A (DARE)</p>			
<p>Note: /</p>			

## 9. ELECTRICAL FAST TRANSIENT/BURST IMMUNITY TEST

### 9.1. Block Diagram of Test Setup

#### 9.1.1. Block Diagram of the EUT



(EUT: Uninterruptible Power Systems)

#### 9.1.2. EFT Test Setup

AC Port:

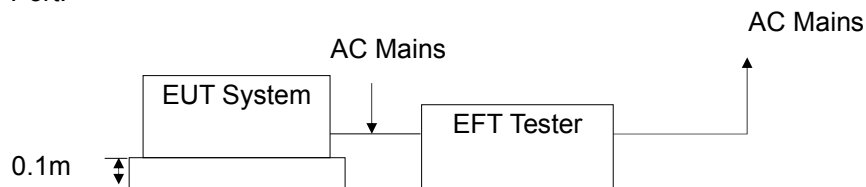

(EUT: Uninterruptible Power Systems)

### 9.2. Test Standard

IEC 61000-4-4:2012 (Level 3: 2kV/5kHz for AC Mains)

### 9.3. Severity Levels and Performance Criterion

#### 9.3.1. Severity level

Open Circuit Output Test Voltage $\pm 10\%$		
Level	On Power Supply Lines	On I/O (Input/Output) Signal data and control lines
1.	0.5 kV	0.25 kV
2.	1 kV	0.5 kV
3.	2 kV	1 kV
4.	4 kV	2 kV
X	Special	Special

#### 9.3.2. Performance criterion : B

Criterion B	
Output characteristics	Voltage permitted to vary within the inverse time characteristics applicable (<100 m sec limits in Figures 1, 2 or 3 of IEC 62040-3)
External and internal indications and metering	Change only during test
Control signals to external devices	Change only temporarily in consistency with the actual Uninterruptible Power Systems mode of operation
Mode of operation	Change only temporarily

#### 9.4. EUT Configuration

The configuration of EUT is listed in Section 4.4.

#### 9.5. Operating Condition of EUT

9.5.1. Setup the EUT as shown in Section 9.1.

9.5.2. Turn on the power of all equipments.

9.5.3. Let the EUT work in test mode (Line mode) and measure it.

#### 9.6. Test Procedure

The EUT is put on the table which is 0.1m high above the ground. This reference ground plane shall project beyond the EUT by at least 0.1m on all sides and the minimum distance between EUT and all other conductive structure, except the ground plane beneath the EUT, shall be more than 0.5m.

9.6.1. For input and output AC power ports:

The EUT is connected to the power mains by using a coupling device which couples the EFT interference signal to AC power lines. Both polarities of the test voltage should be applied during compliance test and the duration of the test is 2 mins.

9.6.2. For signal line and control lines ports:

It's unnecessary to test.

9.6.3. For DC output line ports:

It's unnecessary to test.

#### 9.7. Test Result

**PASS.**

Please refer to the following page.

## Electrical Fast Transient/Burst Test Results

EMTEK(SHENZHEN) CO., LTD.

Standard	IEC 61000-4-4	Result: <input checked="" type="checkbox"/> PASS / <input type="checkbox"/> FAIL	
Applicant : <u>INVT POWER SYSTEM (SHENZHEN) CO., LTD.</u>			
EUT : <u>Uninterruptible Power Systems</u>			
M/N : <u>RM600/30X</u>			
Input Voltage : <u>AC 380V/50Hz</u>			
Actual Criterion : <u>B</u>			
Ambient Condition : <u>23 °C</u> <span style="float: right;"><u>55% RH</u></span>			
Operation Mode: Line mode			
Line : <input checked="" type="checkbox"/> AC input and output power ports		Line : <input type="checkbox"/> Signal <input type="checkbox"/> I/O Cable	
Coupling : <input checked="" type="checkbox"/> Direct		Coupling : <input type="checkbox"/> Capacitive	
Test Time : 120s			
Line	Test Voltage	Result(+)	Result(-)
AC input power ports: L1, L2, L3, N, PE	2KV	A	A
L1-L2, L1-L3, L2-L3, L1-N, L2-N, L3-N	2KV	A	A
L1-PE, L2-PE, L3-PE, N-PE	2KV	A	A
L1-L2-PE, L1-L3-PE, L2-L3-PE, L1-L2-L3, L1-L2-N, L1-L3-N, L2-L3-N, L1-N-PE, L2-N-PE, L3-N-PE	2KV	A	A
L1-L2-L3-PE, L1-L2-L3-N, L1-L2-N-PE, L1-L3-N-PE, L2-L3-N-PE	2KV	A	A
AC output power ports: L1, L2, L3, N, PE	2KV	A	A
L1-L2, L1-L3, L2-L3, L1-N, L2-N, L3-N	2KV	A	A
L1-PE, L2-PE, L3-PE, N-PE	2KV	A	A
L1-L2-PE, L1-L3-PE, L2-L3-PE, L1-L2-L3, L1-L2-N, L1-L3-N, L2-L3-N, L1-N-PE, L2-N-PE, L3-N-PE	2KV	A	A
L1-L2-L3-PE, L1-L2-L3-N, L1-L2-N-PE, L1-L3-N-PE, L2-L3-N-PE	2KV	A	A
DC line			
Signal line			
Note:			
Test Equipment		Burst Tester Model : PEFT 4010	

## 10. SURGE IMMUNITY TEST

### 10.1. Block Diagram of Test Setup

#### 10.1.1. Block Diagram of the EUT



(EUT: Uninterruptible Power Systems)

#### 10.1.2. Surge Test Setup

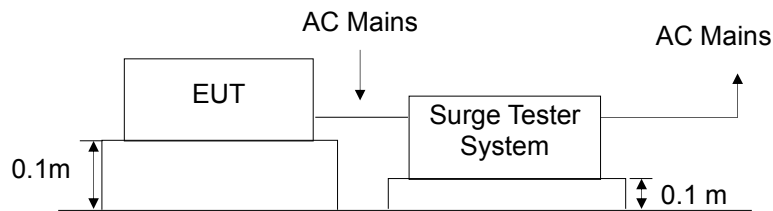

(EUT: Uninterruptible Power Systems)

### 10.2. Test Standard

IEC 61000-4-5:2014 (Line to Line: Level 2, 1.0kV, Line to earth: Level 3, 2.0kV)

### 10.3. Severity Levels and Performance Criterion

#### 10.3.1. Severity level

Severity Level	Open-Circuit Test Voltage kV
1	0.5
2	1.0
3	2.0
4	4.0
*	Special

#### 10.3.2. Performance criterion: B

	Criterion B
Output characteristics	Voltage permitted to vary within the inverse time characteristics applicable (<100 m sec limits in Figures 1, 2 or 3 of IEC 62040-3)
External and internal indications and metering	Change only during test
Control signals to external devices	Change only temporarily in consistency with the actual Uninterruptible Power Systems mode of operation
Mode of operation	Change only temporarily

#### 10.4.EUT Configuration

The configuration of EUT is listed in Section 4.3.

#### 10.5.Operating Condition of EUT

10.5.1.Setup the EUT as shown in Section 10.1.

10.5.2.Turn on the power of all equipments.

10.5.3.Let the EUT work in test mode (Line mode) and measure it.

#### 10.6.Test Procedure

- 1) Set up the EUT and test generator as shown on Section 10.1.2.  
For line to line coupling mode, provide 1kV 1.2/50us voltage surge.  
For line to earth mode, provide 2kV 1.2/50us voltage surge.  
(At open-circuit condition) and 8/20us current surge to EUT selected points.
- 2) At least 5 positive and 5 negative (polarity) tests with a maximum 1/min repetition rate are conducted during test.
- 3) Different phase angles are done individually.
- 4) Record the EUT operating situation during compliance test and decide the EUT immunity criterion for above each test.

#### 10.7.Test Result

**PASS.**

Please refer to the following page.

## Surge Immunity Test Result

EMTEK(SHENZHEN) CO., LTD.

Applicant : INVT POWER SYSTEM (SHENZHEN) CO., LTD.

Test Engineer: YU

EUT : Uninterruptible Power Systems

Test Date : May 25, 2015

M/N : RM600/30X

Temperature : 23°C

Power Supply : AC 230V / 50Hz

Humidity : 51%

Test Mode : Line mode

Criterion : B

Location	Polarity	Phase Angle	Number of Pulse	Pulse Voltage (kV)	Result
AC Input: L1-L2, L1-L3, L2-L3	+	0°, 90°, 180°, 270°	5	1.0	A
	-	0°, 90°, 180°, 270°	5	1.0	A
L1-N, L2-N, L3-N	+	0°, 90°, 180°, 270°	5	1.0	A
	-	0°, 90°, 180°, 270°	5	1.0	A
L1-PE, L2-PE, L3-PE	+	0°, 90°, 180°, 270°	5	2.0	A
	-	0°, 90°, 180°, 270°	5	2.0	A
N-PE	+	0°, 90°, 180°, 270°	5	2.0	A
	-	0°, 90°, 180°, 270°	5	2.0	A
AC Output: L1-L2, L1-L3, L2-L3	+	Random	5	1.0	A
	-	Random	5	1.0	A
L1-N, L2-N, L3-N	+	Random	5	1.0	A
	-	Random	5	1.0	A
L1-PE, L2-PE, L3-PE	+	Random	5	2.0	A
	-	Random	5	2.0	A
N-PE	+	Random	5	2.0	A
	-	Random	5	2.0	A

Note:



## 11. INJECTED CURRENTS SUSCEPTIBILITY TEST

### 11.1. Block Diagram of Test Setup

#### 11.1.1. Block Diagram of the EUT



(EUT: Uninterruptible Power Systems)

#### 11.1.2. Block Diagram of Test Setup

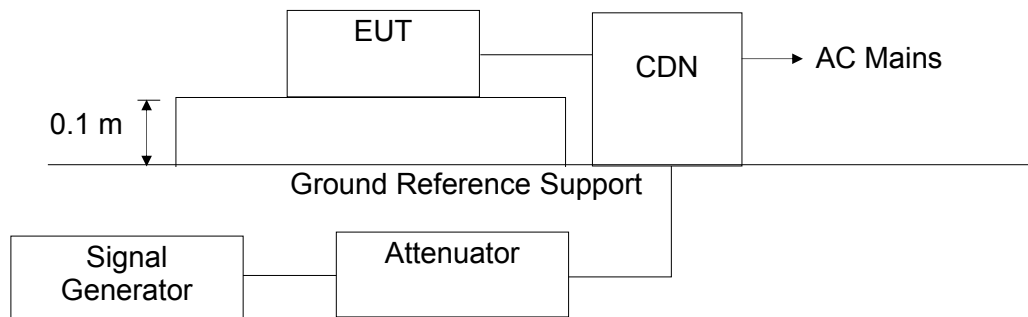

### 11.2. Test Standard

IEC 61000-4-6:2013 (Level 3: 10V (rms) (0.15MHz ~ 80MHz))

### 11.3. Severity Levels and Performance Criterion

#### 11.3.1. Severity level

Level	Field Strength V
1	1
2	3
3	10
X	Special

#### 11.3.2. Performance criterion: A

	Criterion A
External and internal indications and metering (LCD)	No change
Output characteristics (Load)	No change
Control signals to external devices (Signal line)	No change
Mode of operation	No change

#### 11.4.EUT Configuration

The configuration of EUT is listed in Section 4.3.

#### 11.5.Operating Condition of EUT

11.5.1.Setup the EUT as shown in Section 11.1.

11.5.2.Turn on the power of all equipments.

11.5.3.Let the EUT work in test mode (Line mode) and measure it.

#### 11.6.Test Procedure

- 1) Set up the EUT, CDN and test generators as shown on Section 13.1.2.
- 2) Let the EUT work in test mode and measure it.
- 3) The EUT are placed on an insulating support 0.1m high above a ground reference plane. CDN (coupling and decoupling device) is placed on the ground plane about 0.3m from EUT. Cables between CDN and EUT are as short as possible, and their height above the ground reference plane shall be between 30 and 50 mm (where possible).
- 4) The disturbance signal described below is injected to EUT through CDN.
- 5) The EUT operates within its operational mode(s) under intended climatic conditions after power on.
- 6) The frequency range is swept from 150KHz to 80MHz using 10V signal level, and with the disturbance signal 80% amplitude modulated with a 1KHz sine wave.
- 7) The rate of sweep shall not exceed  $1.5 \cdot 10^{-3}$  decades/s. Where the frequency is swept incrementally, the step size shall not exceed 1% of the start and thereafter 1% of the preceding frequency value.
- 8) Recording the EUT operating situation during compliance testing and decide the EUT immunity criterion.

#### 11.7.Test Results

**PASS.**

Please refer to the following page.

## Injected Currents Susceptibility Test Results

EMTEK(SHENZHEN) CO., LTD.

Applicant : <u>INVT POWER SYSTEM (SHENZHEN) CO., LTD.</u> EUT : <u>Uninterruptible Power Systems</u> M/N : <u>RM600/30X</u> Power Supply : <u>AC 380V/50Hz</u> Test Engineer : <u>YU</u>		Test Date : <u>May 25, 2015</u> Temperature : <u>23°C</u> Humidity : <u>50%</u> Actual Criterion : <u>A</u>		
Test Mode : Line mode				
Frequency Range (MHz)	Injected Position	Strength (Unmodulated)	Criterion	Result
0.15 ~ 80	AC Input	10V	A	A
0.15 ~ 80	AC Output	10V	A	A
Remark : 1. Modulation Signal:1KHz 80% AM Measurement Equipment : Simulator: CIT-10 CDN : <input type="checkbox"/> CDN-M332 <input type="checkbox"/> CDN-M432 <input checked="" type="checkbox"/> CDN-M532			Note: /	

## 12. MAGNETIC FIELD SUSCEPTIBILITY TEST

### 12.1. Block Diagram of Test

#### 12.1.1. Block diagram of test setup

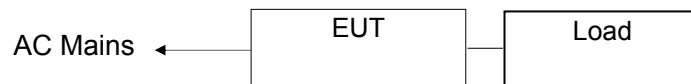

(EUT: Uninterruptible Power Systems)

#### 12.1.2. Magnetic field test setup

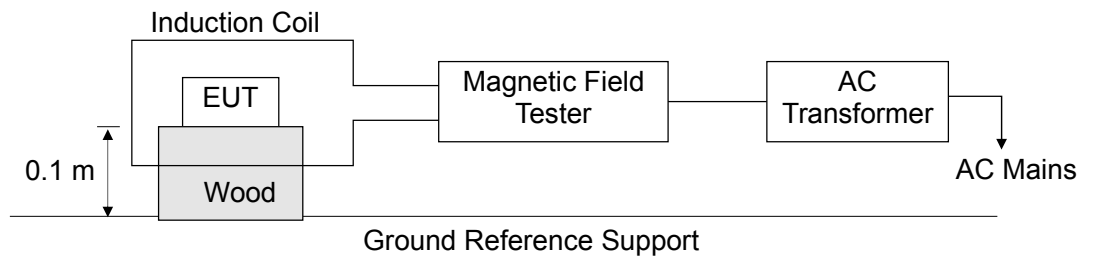

(EUT: Uninterruptible Power Systems)

### 12.2. Test Standard

IEC 61000-4-8:2009, (Severity Level 4: 30A / m)

### 12.3. Severity Levels and Performance Criterion

#### 12.3.1. Severity Levels

Level	Field Strength A/m
1	1
2	3
3	10
4	30
5	100
X	Special

### 12.3.2.Performance Criterion: A

	Criterion A
Output characteristics	Voltage permitted to vary within the inverse time characteristics applicable (<100 m sec limits in Figures 1, 2 or 3 of IEC 62040-3)
External and internal indications and metering	Change only during test
Control signals to external devices	Change only temporarily in consistency with the actual Uninterruptible Power Systems mode of operation
Mode of operation	Change only temporarily

### 12.4.EUT Configuration on Test

The configuration of the EUT is same as Section 4.3.

### 12.5.Test Procedure

The EUT is placed in the middle of a induction coil, under which is a 0.1m (high) table, this small table is also placed on a larger table, 0.8 m above the ground. Both horizontal and vertical polarization of the induction coil is set on test, so that each side of the EUT is affected by the magnetic field. Also can reach the same aim by change the position of the EUT.

### 12.6.Test Results

**PASS.**

Please refer to the following page.

## Magnetic Field Immunity Test Result

EMTEK(SHENZHEN) CO., LTD.

Standard	IEC 61000-4-8		Result: <input checked="" type="checkbox"/> Pass / <input type="checkbox"/> Fail	
<p>Applicant : <u>INVT POWER SYSTEM (SHENZHEN) CO., LTD.</u></p> <p>EUT : <u>Uninterruptible Power Systems</u> M/N : <u>RM600/30X</u></p> <p>Input Voltage : <u>AC 380V/50Hz</u></p> <p>Date of Test : <u>May 25, 2015</u> Test Engineer : <u>YU</u></p> <p>Ambient Condition : Temp : <u>22°C</u> Humid : <u>50%</u></p> <p>Actual Criterion : A</p>				
Operation Mode : Line mode				
Test Level (A/M)	Testing Duration	Coil Orientation	Criterion	Result
30	5 mins	X	A	A
30	5 mins	Y	A	A
30	5 mins	Z	A	A
Operation Mode : N/A				
Test Level (A/M)	Testing Duration	Coil Orientation	Criterion	Result
Test Equipment	Magnetic Field Test : HEAFELY MAG 100.1			
Note: /				

## 13. VOLTAGE DIPS AND INTERRUPTIONS TEST

### 13.1. Block Diagram of Test Setup

#### 13.1.1. Block Diagram of the EUT

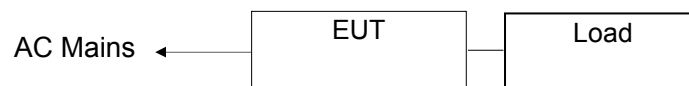

(EUT: Uninterruptible Power Systems)

#### 13.1.2. Dips Test Setup

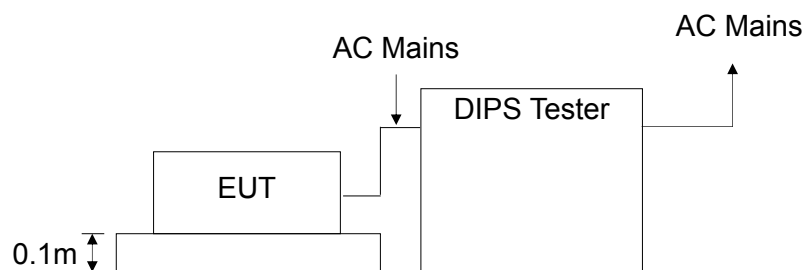

(EUT: Uninterruptible Power Systems)

### 13.2. Test Standard

IEC 61000-4-11:2004

### 13.3. Severity Levels and Performance Criterion

#### 13.3.1. Severity level

Test Level %UT	Voltage dip and short interruptions %UT	Duration (in period)
0	100	0.5
40	60	1
70	30	5
		10
		25
		50
		*

13.3.2.Performance criterion: B

	Criterion B
Output characteristics	Voltage permitted to vary within the inverse time characteristics applicable (<100 m sec limits in Figures 1, 2 or 3 of IEC 62040-3)
External and internal indications and metering	Change only during test
Control signals to external devices	Change only temporarily in consistency with the actual Uninterruptible Power Systems mode of operation
Mode of operation	Change only temporarily

13.4.EUT Configuration

The configuration of EUT is listed in Section 4.3.

13.5.Operating Condition of EUT

13.5.1.Setup the EUT as shown in Section 13.1.

13.5.2.Turn on the power of all equipments.

13.5.3.Let the EUT work in test mode (Line mode) and measure it.

13.6.Test Procedure

- 1) Set up the EUT and test generator as shown on Section 13.1.2.
- 2) The interruption is introduced at selected phase angles with specified duration.
- 3) Record any degradation of performance.

13.7.Test Result

**PASS.**

Please refer to the following page.



## Voltage Dips And Interruptions Test Results

EMTEK(SHENZHEN) CO., LTD.

Applicant : <u>INVT POWER SYSTEM (SHENZHEN) CO., LTD.</u>		Test Date : <u>May 25, 2015</u>		
EUT : <u>Uninterruptible Power Systems</u>		Temperature : <u>22°C</u>		
M/N : <u>RM600/30X</u>		Humidity : <u>50%</u>		
Power Supply : <u>AC 380V/50Hz</u>		Test Engineer : <u>YU</u>		
Test Mode: Line mode				
Test Level % U <sub>T</sub>	Voltage Dips & Short Interruptions % U <sub>T</sub>	Duration (in periods)	Criterion <input type="checkbox"/> A <input checked="" type="checkbox"/> B <input type="checkbox"/> C <input type="checkbox"/> D	Result
0	100	0.5P	B	A
0	100	1P	B	A
70	30	25P	B	A
0	100	250P	B	B
Note: Test in 0%, 250P, light appears flicker, but can self-recovery.				

## 14. TEST PHOTOGRAPH

### 14.1.Photos of Conducted Emission Measurement



### 14.2. Photo of Radiation Emission Measurement



### 14.3. Photo of Electrostatic Discharge Test



14.4. Photo of RF Field Strength susceptibility Test



14.5. Photos of Electrical Fast Transient/Burst Test





14.6.Photo of Surge Test



14.7.Photo of Injected Currents Susceptibility Test



#### 14.8. Photo of Magnetic Field Immunity Test



#### 14.9. Photo of Voltage dips and interruption Test



## APPENDIX (Photos of EUT)





