

Standards EN62040-2: 2006

TEST REPORT

For

INVT POWER SYSTEM(SHENZHEN) CO., LTD

Uninterruptible Power Systems

Model Number: HR1105XL, HR1105XS, HR1106XL, HR1106XS, HR1108XL,
HR1108XS, HR1110XL, HR1110XS

Prepared for : INVT POWER SYSTEM(SHENZHEN) CO., LTD
Address : 5th Floor, 1#Building, Gaofa Industrial Park, LongJing,
Nanshan District, Shenzhen, China, 518055

Prepared by : EMTEK (SHENZHEN) CO., LTD.
Address : Bldg 69, Majialong Industry Zone,
Nanshan District, Shenzhen, Guangdong, China

Tel: (0755) 26954280
Fax: (0755) 26954282

Report Number : ES170314008E
Date of Test : March 16, 2017 to March 31, 2017
Date of Report : April 01, 2017

TABLE OF CONTENT

Description	Page
1. SUMMARY OF TEST RESULTS.....	7
2. GENERAL INFORMATION.....	8
2.1. Description of Device (EUT).....	8
2.2. Description of Support Device.....	9
2.3. Description of Test Facility.....	9
2.4. Measurement Uncertainty.....	10
3. MEASURING DEVICE AND TEST EQUIPMENT.....	11
3.1. For Conducted Emission Measurement.....	11
3.2. For Radiated Emission Measurement.....	11
3.3. For Electrostatic Discharge Immunity Test.....	11
3.4. For RF Strength Susceptibility Test.....	11
3.5. For Electrical Fast Transient/Burst Immunity Test.....	12
3.6. For Surge Immunity Test.....	12
3.7. For Injected Current Susceptibility Test.....	12
3.8. For Magnetic Field Immunity Test.....	12
3.9. For Voltage Dips and Interruptions Test.....	12
3.10. Low Frequency Signals and Power Line Unbalance Test.....	13
4. CONDUCTED EMISSION MEASUREMENT.....	14
4.1. Block Diagram of Test Setup.....	14
4.2. Measuring Standard.....	14
4.3. Power Line Conducted Emission Limits (C3).....	14
4.4. EUT Configuration of Measurement.....	14
4.5. Operating Condition of EUT.....	15
4.6. Test Procedure.....	15
4.7. Measuring Results.....	15
5. RADIATED EMISSION MEASUREMENT.....	20
5.1. Block Diagram of Test.....	20
5.2. Measuring Standard.....	20
5.3. Radiated Emission Limits(C3).....	20
5.4. EUT Configuration on Test.....	21
5.5. Operating Condition of EUT.....	21
5.6. Test Procedure.....	21
5.7. Measuring Results.....	21
6. IMMUNITY PERFORMANCE CRITERIA DESCRIPTION.....	26
7. ELECTROSTATIC DISCHARGE IMMUNITY TEST.....	28
7.1. Block Diagram of Test Setup.....	28
7.2. Test Standard.....	28
7.3. Severity Levels and Performance Criterion.....	28
7.4. EUT Configuration.....	29
7.5. Operating Condition of EUT.....	29
7.6. Test Procedure.....	29
7.7. Test Results.....	29
8. RF FIELD STRENGTH SUSCEPTIBILITY TEST.....	31
8.1. Block Diagram of Test.....	31
8.2. Test Standard.....	31
8.3. Severity Levels and Performance Criterion.....	32
8.4. EUT Configuration on Test.....	32
8.5. Operating Condition of EUT.....	32
8.6. Test Procedure.....	32

8.7. Test Results.....	32
9. ELECTRICAL FAST TRANSIENT/BURST IMMUNITY TEST.....	34
9.1. Block Diagram of Test Setup.....	34
9.2. Test Standard.....	34
9.3. Severity Levels and Performance Criterion.....	34
9.4. EUT Configuration.....	35
9.5. Operating Condition of EUT.....	35
9.6. Test Procedure.....	35
9.7. Test Result.....	35
10. SURGE IMMUNITY TEST.....	37
10.1. Block Diagram of Test Setup.....	37
10.2. Test Standard.....	37
10.3. Severity Levels and Performance Criterion.....	37
10.4. EUT Configuration.....	38
10.5. Operating Condition of EUT.....	38
10.6. Test Procedure.....	38
10.7. Test Result.....	38
11. INJECTED CURRENTS SUSCEPTIBILITY TEST.....	40
11.1. Block Diagram of Test Setup.....	40
11.2. Test Standard.....	40
11.3. Severity Levels and Performance Criterion.....	40
11.4. EUT Configuration.....	41
11.5. Operating Condition of EUT.....	41
11.6. Test Procedure.....	41
11.7. Test Results.....	41
12. MAGNETIC FIELD SUSCEPTIBILITY TEST.....	43
12.1. Block Diagram of Test.....	43
12.2. Test Standard.....	43
12.3. Severity Levels and Performance Criterion.....	43
12.4. EUT Configuration on Test.....	44
12.5. Test Procedure.....	44
12.6. Test Results.....	44
13. VOLTAGE DIPS AND INTERRUPTIONS TEST.....	46
13.1. Block Diagram of Test Setup.....	46
13.2. Test Standard.....	46
13.3. Severity Levels and Performance Criterion.....	46
13.4. EUT Configuration.....	47
13.5. Operating Condition of EUT.....	47
13.6. Test Procedure.....	47
13.7. Test Result.....	47
14. LOW FREQUENCY SIGNALS TEST.....	49
14.1. Block Diagram of Test Setup.....	49
14.2. Test Standard.....	49
14.3. Operating Condition of EUT.....	49
14.4. Test Results.....	49
15. TEST PHOTOGRAPHS.....	51
15.1. Photos of Conducted Emission Measurement.....	51
15.2. Photos of Radiation Emission Measurement.....	52
15.3. Photo of Electrostatic Discharge Test.....	53
15.4. Photo of RF Field Strength susceptibility Test.....	53
15.5. Photos of Electrical Fast Transient/Burst Test.....	54
15.6. Photo of Surge Test.....	54
15.7. Photo of Injected Currents Susceptibility Test.....	55
15.8. Photo of Magnetic Field Immunity Test.....	55
15.9. Photo of Voltage dips and interruption Test.....	56

15.10. Photo of Low Frequency Signals Test.....56

APPENDIX (Photos of EUT) (11 Pages)

TEST REPORT VERIFICATION

Applicant : INVT POWER SYSTEM(SHENZHEN) CO., LTD
 Manufacturer : INVT POWER SYSTEM(SHENZHEN) CO., LTD
 Trademark : INVT
 EUT : Uninterruptible Power Systems
 Model Number : HR1105XL, HR1105XS, HR1106XL, HR1106XS, HR1108XL, HR1108XS, HR1110XL, HR1110XS
 Power Supply : Please refer to page 8

Measurement Procedure Used:

EN62040-2: 2006,
 (IEC 61000-4-2:2008, IEC 61000-4-3:2006+A1:2007+A2:2010, IEC 61000-4-4:2012,
 IEC 61000-4-5:2014, IEC 61000-4-6:2013, IEC 61000-4-8:2009, IEC 61000-4-11:2004,
 IEC 61000-2-2:2002)

The device described above is tested by EMTEK (SHENZHEN) CO., LTD. to determine the maximum emission levels emanating from the device and the severe levels of the device can endure and its performance criterion. The measurement results are contained in this test report and EMTEK (SHENZHEN) CO., LTD. is assumed full of responsibility for the accuracy and completeness of these measurements. Also, this report shows that the EUT (Equipment Under Test) is technically compliant with the EN 62040-2 requirements.

In this report the model and configuration chosen for each test is representative for all models or configurations (defined in the user manual) by using The "Worst Case" approach of the Guide for the EMC Directive 2014/30/EU.

This report applies to above tested sample only and shall not be reproduced in part without written approval of EMTEK (SHENZHEN) CO., LTD.

Date of Test : March 16, 2017 to March 31, 2017

Prepared by : Bunny Zhang
 Bunny Zhang/Editor

Reviewer : Jessie Hu
 Jessie Hu/Supervisor

Approved & Authorized Signer : Lisa Wang
 Lisa Wang/Manager

Modified Information

Version	Report No.	Revision Date	Summary
Ver.1.0	ES170314008E	/	Original Report

1. SUMMARY OF TEST RESULTS

EMISSION			
Description of test item	Standard	Limits	Results
Conducted disturbance at mains terminals	EN62040-2: 2006	C3	Pass
Radiated Disturbance	EN62040-2: 2006	C3	Pass
Immunity			
Description of test item	Basic Standard	Performance Criteria	Results
Electrostatic Discharge (ESD)	IEC 61000-4-2:2008	B	Pass
Radio-frequency, Continuous radiated disturbance	IEC 61000-4-3:2006+A1:2007+A2:2010	A	Pass
EFT/B Immunity	IEC 61000-4-4:2012	B	Pass
Surge Immunity	IEC 61000-4-5:2014	B	Pass
Conducted RF Immunity	IEC 61000-4-6:2013	A	Pass
Power frequency magnetic field	IEC 61000-4-8:2009	A	Pass
Voltage dips and Voltage interruptions	IEC 61000-4-11:2004	B	Pass
Low Frequency signals	IEC 61000-2-2:2002	A	Pass
Note: /			

2. GENERAL INFORMATION

2.1. Description of Device (EUT)

EUT	:	Uninterruptible Power Systems
Model Number	:	HR1105XL, HR1105XS, HR1106XL, HR1106XS, HR1108XL, HR1108XS, HR1110XL, HR1110XS (Note: These models are identical in circuitry and electrical, mechanical and physical construction; the only differences are the rating and model number. for trading purpose. We prepare HR1110XL for test.)
Input Rating	:	<p>HR1105XL: AC Input: 110-288VAC, 1 ϕ +N+PE, 50Hz/60HZ, 30Amax Batt. Input: 192-288VDC, 34Amax</p> <p>HR1105XS: AC Input: 110-288VAC, 1 ϕ +N+PE, 50Hz/60HZ, 30Amax Batt. Input: 192-288VDC, 34Amax</p> <p>HR1106XL: AC Input: 110-288VAC, 1 ϕ +N+PE, 50Hz/60HZ, 36Amax Batt. Input: 192-288VDC, 40Amax</p> <p>HR1106XS: AC Input: 110-288VAC, 1 ϕ +N+PE, 50Hz/60HZ, 36Amax Batt. Input: 192-288VDC, 40Amax</p> <p>HR1108XL: AC Input: 110-288VAC, 1 ϕ +N+PE, 50Hz/60HZ, 48Amax Batt. Input: 192-288VDC, 54Amax</p> <p>HR1108XS: AC Input: 110-288VAC, 1 ϕ +N+PE, 50Hz/60HZ, 48Amax Batt. Input: 192-288VDC, 54Amax</p> <p>HR1110XL: AC Input: 110-288VAC, 1 ϕ +N+PE, 50Hz/60HZ, 60Amax Batt. Input: 192-288VDC, 66Amax</p> <p>HR1110XS: AC Input: 110-288VAC, 1 ϕ +N+PE, 50Hz/60HZ, 60Amax Batt. Input: 192-288VDC, 66Amax</p>
Output Rating	:	<p>HR1105XL: AC Output: 200/208/220/230/240Vac, 23Amax, 1ϕ+N+PE, 50/60Hz, 5KVA/5KW</p> <p>HR1105XS: AC Output: 200/208/220/230/240Vac, 23Amax, 1ϕ+N+PE, 50/60Hz, 5KVA/5KW</p> <p>HR1106XL: AC Output: 200/208/220/230/240Vac, 28Amax, 1ϕ+N+PE, 50/60Hz, 6KVA/6KW</p> <p>HR1106XS: AC Output: 200/208/220/230/240Vac, 28Amax, 1ϕ+N+PE, 50/60Hz, 6KVA/6KW</p>

HR1108XL:
AC Output: 200/208/220/230/240Vac,
37Amax,1Φ+N+PE,50/60Hz,8KVA/8KW
HR1108XS:
AC Output: 200/208/220/230/240Vac,
37Amax,1Φ+N+PE,50/60Hz,8KVA/8KW

HR1110XL:
AC Output: 200/208/220/230/240Vac,
46Amax,1Φ+N+PE,50/60Hz,10KVA/10KW
HR1110XS:
AC Output: 200/208/220/230/240Vac,
46Amax,1Φ+N+PE,50/60Hz,10KVA/10KW

Test voltage : AC 230V/50Hz
Applicant : INVT POWER SYSTEM(SHENZHEN) CO., LTD
Address : 5th Floor, 1#Building,Gaofa Industrial Park, LongJing, Nanshan District,
Shenzhen,China, 518055
Manufacturer : INVT POWER SYSTEM(SHENZHEN) CO., LTD
Address : 5th Floor, 1#Building,Gaofa Industrial Park, LongJing, Nanshan District,
Shenzhen,China, 518055
Date of receiver : March 16, 2017
Date of Test : March 16, 2017 to March 31, 2017

2.2. Description of Support Device

N/A

2.3. Description of Test Facility

Site Description
EMC Lab. : Accredited by CNAS, 2016.10.24
The certificate is valid until 2022.10.28
The Laboratory has been assessed and proved to be in compliance
with CNAS-CL01: 2006 (identical to ISO/IEC17025: 2005)
The Certificate Registration Number is L2291.

Accredited by TUV Rheinland Guangzhou 2010.5.25
The Laboratory has been assessed according to the requirements
ISO/IEC 17025

Accredited by FCC, 2017/07/12
The Certificate Registration Number. is 406365.

Accredited by Industry Canada, November 24, 2015
The Certificate Registration Number. is 4480A.

Name of Firm : EMTEK(SHENZHEN) CO., LTD.
Site Location : Bldg 69, Majialong Industry Zone,
Nanshan District, Shenzhen, Guangdong, China

2.4. Measurement Uncertainty

Test Item	Uncertainty
Conducted Emission Uncertainty	: 3.16dB(9k~150kHz Conduction 2#) 2.90dB(150k-30MHz Conduction 2#)
Radiated Emission Uncertainty (3m Chamber)	: 3.78dB (30M~1GHz Polarize: H) 4.27dB (30M~1GHz Polarize: V)
Uncertainty for C/S Test	: 1.45(Using CDN Test)
Uncertainty for R/S Test	: 2.10dB(80MHz-200MHz) 1.76dB(200MHz-1000MHz)
Uncertainty for test site temperature and humidity	: 0.6°C 4%

3. MEASURING DEVICE AND TEST EQUIPMENT

3.1. For Conducted Emission Measurement

Used	Equipment	Manufacturer	Model No.	Serial No.	Last Cal.	Cal. Interval
<input checked="" type="checkbox"/>	Test Receiver	Rohde & Schwarz	ESCS30	828985/018	May 29, 2016	1 Year
<input checked="" type="checkbox"/>	L.I.S.N.	Schwarzbeck	NNLK8129	8129-203	May 28, 2016	1 Year
<input checked="" type="checkbox"/>	50Ω Coaxial Switch	Anritsu	MP59B	M20531	May 29, 2016	1 Year
<input checked="" type="checkbox"/>	Pulse Limiter	Rohde & Schwarz	ESH3-Z2	100006	May 28, 2016	1 Year

3.2. For Radiated Emission Measurement

Used	Equipment	Manufacturer	Model No.	Serial No.	Last Cal.	Cal. Interval
<input checked="" type="checkbox"/>	EMI Test Receiver	Rohde & Schwarz	ESCI3	1166.5950K03-10138 4Bw	May 28, 2016	1 Year
<input checked="" type="checkbox"/>	Pre-Amplifier	LUNAR-EM	LNA30M3G-25	J10100000070	May 28, 2016	1 Year
<input checked="" type="checkbox"/>	Bilog Antenna	Schwarzbeck	VULB9163	141	May 28, 2016	1 Year
<input checked="" type="checkbox"/>	Cable	H+B	NmSm-05-C15051 0.5M	N/A	May 29, 2016	1 Year
<input checked="" type="checkbox"/>	Cable	H+B	NmSm-2-C15202 2M	N/A	May 29, 2016	1 Year
<input checked="" type="checkbox"/>	Cable	H+B	NmNm-7-C15701 7M	N/A	May 29, 2016	1 Year

3.3. For Electrostatic Discharge Immunity Test

Used	Equipment	Manufacturer	Model No.	Serial No.	Last Cal.	Cal. Interval
<input checked="" type="checkbox"/>	ESD Tester	TESEQ AG	NSG 438A	130	May 29, 2016	1 Year
<input checked="" type="checkbox"/>	Impulse Module	TESEQ AG	IN NSG 438A A 4380-150pF/330Ohm	403-550/1712	May 29, 2016	1 Year

3.4. For RF Strength Susceptibility Test

Used	Equipment	Manufacturer	Model No.	Serial No.	Last Cal.	Cal. Interval
<input checked="" type="checkbox"/>	Signal Generator	Agilent	N5181A	MY50145187	May 28, 2016	1 Year
<input checked="" type="checkbox"/>	RF Power Meter. Dual Channel	BOONTON	4232A	10539	May 29, 2016	1 Year
<input checked="" type="checkbox"/>	50ohm Diode Power Sensor	BOONTON	51011EMC	34236/34238	May 29, 2016	1 Year
<input checked="" type="checkbox"/>	Field Strength Meter	DARE	RSS1006A	10I00037SO 22	May 29, 2016	1 Year
<input checked="" type="checkbox"/>	50ohm Diode Power Sensor	BOONTON	51011EMC	36164	May 29, 2016	1 Year
<input checked="" type="checkbox"/>	Power Amplifier	MILMEGA	80RF1000-175	1059345	May 28, 2016	1 Year
<input type="checkbox"/>	Power Amplifier	MILMEGA	AS0102-55	1018770	May 28, 2016	1 Year
<input checked="" type="checkbox"/>	Power Amplifier	MILMEGA	AS1860-50	1059346	May 28, 2016	1 Year
<input checked="" type="checkbox"/>	Log.-Per. Antenna	SCHWARZBECK	VULP 9118E	811	May 29, 2016	1 Year
<input type="checkbox"/>	Broad-Band Horn Antenna	SCHWARZBECK	STLP 9149	9149-227	May 29, 2016	1 Year
<input checked="" type="checkbox"/>	Multi-function interface system	DARE	CTR1009B	12I00250SN O72	N/A	N/A
<input checked="" type="checkbox"/>	Automatic switch group	DARE	RSW1004A	N/A	N/A	N/A

3.5. For Electrical Fast Transient/Burst Immunity Test

Used	Equipment	Manufacturer	Model No.	Serial No.	Last Cal.	Cal. Interval
<input checked="" type="checkbox"/>	Burst Tester	HAEFELY	PEFT4010	080981-16	May 29, 2016	1Year
<input type="checkbox"/>	Coupling Clamp	HAEFELY	IP-4A	147147	May 29, 2016	1Year

3.6. For Surge Immunity Test

Used	Equipment	Manufacturer	Model No.	Serial No.	Last Cal.	Cal. Interval
<input checked="" type="checkbox"/>	Surge Controller	HAEFELY	Psurge 8000	174031	May 29, 2016	1Year
<input checked="" type="checkbox"/>	Impulse Module	HAEFELY	PIM 100	174124	May 29, 2016	1Year
<input checked="" type="checkbox"/>	Coupling Decoupling Filter	HAEFELY	PCD 130	172181	May 29, 2016	1Year
<input type="checkbox"/>	Coupling Module	HAEFELY	PCD122	174354	May 29, 2016	1Year
<input type="checkbox"/>	Surge Impulse Module	HAEFELY	PIM 120	174435	May 29, 2016	1Year
<input type="checkbox"/>	Coupling Module	HAEFELY	PCD 126A	174387	May 29, 2016	1Year
<input type="checkbox"/>	Impulse Module	HAEFELY	PIM 110	174391	May 29, 2016	1Year
<input type="checkbox"/>	Impulse Module	HAEFELY	PIM 150	178707	May 29, 2016	1Year

3.7. For Injected Current Susceptibility Test

Used	Equipment	Manufacturer	Model No.	Serial No.	Last Cal.	Cal. Interval
<input checked="" type="checkbox"/>	Simulator	EMTEST	CWS500C	0900-12	May 29, 2016	1Year
<input type="checkbox"/>	CDN	EMTEST	CDN-M2	5100100100	May 29, 2016	1Year
<input checked="" type="checkbox"/>	CDN	EMTEST	CDN-M3	0900-11	May 29, 2016	1Year
<input type="checkbox"/>	Injection Clamp	EMTEST	F-2031-23MM	368	May 29, 2016	1Year
<input checked="" type="checkbox"/>	Attenuator	EMTEST	ATT6	0010222A	May 29, 2016	1Year

3.8. For Magnetic Field Immunity Test

Used	Equipment	Manufacturer	Model No.	Serial No.	Last Cal.	Cal. Interval
<input checked="" type="checkbox"/>	Magnetic Field Tester	HAEFELY	MAG100	250040.1	May 28, 2016	1Year

3.9. For Voltage Dips and Interruptions Test

Used	Equipment	Manufacturer	Model No.	Serial No.	Last Cal.	Cal. Interval
<input checked="" type="checkbox"/>	45KVA AC Power source	Teseq	NSG 1007-45/45KVA	1305A02873	May 28, 2016	1 Year
<input type="checkbox"/>	Signal conditioning Unit	Teseq	CCN 1000-3	1305A02873	May 28, 2016	1 Year
<input type="checkbox"/>	Three phase impedance network	Teseq/Germany	INA2197/37A	1305A02873	May 28, 2016	1 Year
<input type="checkbox"/>	Three phase impedance network	Teseq/Germany	INA 2196/75A	1305A02874	May 28, 2016	1 Year
<input checked="" type="checkbox"/>	Proflin 2100 AC Switching Unit	Teseq/Germany	NSG2200-3	A22714	May 28, 2016	1 Year

3.10.Low Frequency Signals and Power Line Unbalance Test

Used	Equipment	Manufacturer	Model No.	Serial No.	Last Cal.	Cal. Interval
<input checked="" type="checkbox"/>	Programmable AC Source	CHROMA	6530	/	May 29, 2016	1Year

4. CONDUCTED EMISSION MEASUREMENT

4.1. Block Diagram of Test Setup

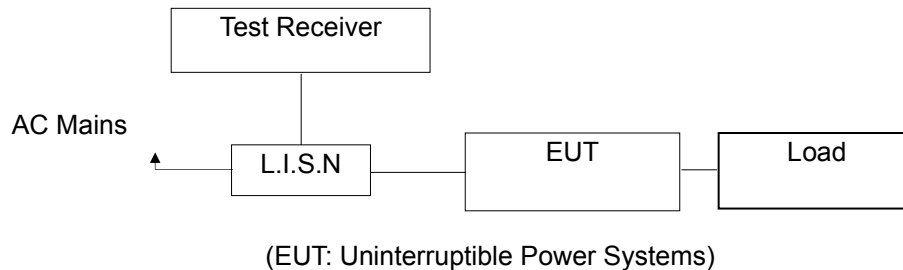

4.2. Measuring Standard

EN62040-2: 2006, Category C3

4.3. Power Line Conducted Emission Limits (C3)

UPS rated output current A	Frequency range MHz	Limits dB (μV)	
		Quasi-peak	Average
>16 – 100	0,15 to 0,50 ^b	100	90
	0,50 to 5,0 ^b	86	76
	5,0 to 30,0	90 to 70 ^a	80 to 60 ^a
>100	0,15 to 0,50 ^b	130	120
	0,50 to 5,0 ^b	125	115
	5,0 to 30,0	115	105

^a The limits decrease linearly with the logarithm of the frequency.
^b The lower limit shall apply at the transition frequency.

4.4. EUT Configuration of Measurement

The following equipments are installed on Conducted Emission Measurement to meet EN 62040-2 requirements and operating in a manner which tends to maximize its emission characteristics in a normal application.

Uninterruptible Power Systems (EUT)
 Model Number : HR1110XL
 Serial Number : N/A

4.5. Operating Condition of EUT

4.5.1. Setup the EUT as shown on Section 4.1.

4.5.2. Turn on the power of all equipment.

4.5.3. Let the EUT work in measuring mode (Line mode, Bat mode) and measure it.

4.6. Test Procedure

The EUT is put on the ground by insulating support and connected to the AC mains through Line Impedance Stability Network (L.I.S.N). This provided a 50ohm coupling impedance for the tested equipments. Both sides of AC line are investigated to find out the maximum conducted emission according to the EN62040-2 regulations during conducted emission measurement.

The bandwidth of the field strength meter (R&S Test Receiver ESCS30) is set at 9kHz in 150kHz~30MHz and 200Hz in 9kHz~150kHz.

The frequency range from 150kHz to 30MHz is investigated.

All the modes were tested and the data of the worsted mode(Bat mode)are attached in the following pages.

4.7. Measuring Results

PASS.

Please refer to the following pages.

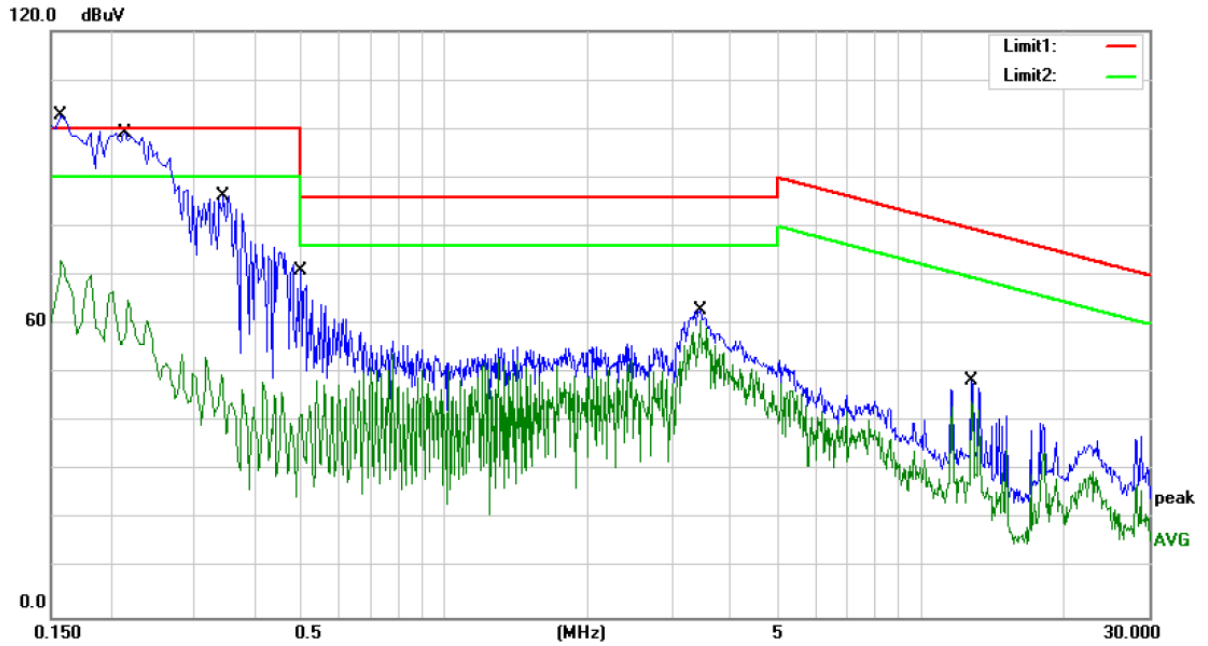

Site Conduction #2 Phase: **L1** Temperature: 21
 Limit: (CE)EN62040-2 C3_QP Power: AC 230V/50Hz Humidity: 53 %
 Mode: Bat MODE
 Note: Internal battery

No.	Mk.	Freq. MHz	Reading Level dBuV	Correct Factor dB	Measure- ment dBuV	Limit dBuV	Over dB	Detector	Comment
1	*	0.1580	78.68	9.62	88.30	100.00	-11.70	QP	
2		0.1580	63.39	9.62	73.01	90.00	-16.99	AVG	
3		0.2140	76.96	9.64	86.60	100.00	-13.40	QP	
4		0.2140	57.19	9.64	66.83	90.00	-23.17	AVG	
5		0.3460	76.63	9.67	86.30	100.00	-13.70	QP	
6		0.3460	40.09	9.67	49.76	90.00	-40.24	AVG	
7		0.5020	61.24	9.71	70.95	86.00	-15.05	QP	
8		0.5020	33.59	9.71	43.30	76.00	-32.70	AVG	
9		3.4420	52.87	9.86	62.73	86.00	-23.27	QP	
10		3.4420	51.00	9.86	60.86	76.00	-15.14	AVG	
11		12.7620	37.73	10.64	48.37	79.54	-31.17	QP	
12		12.7620	33.68	10.64	44.32	69.54	-25.22	AVG	

*:Maximum data x:Over limit !:over margin Comment: Factor build in receiver. Operator: Stan

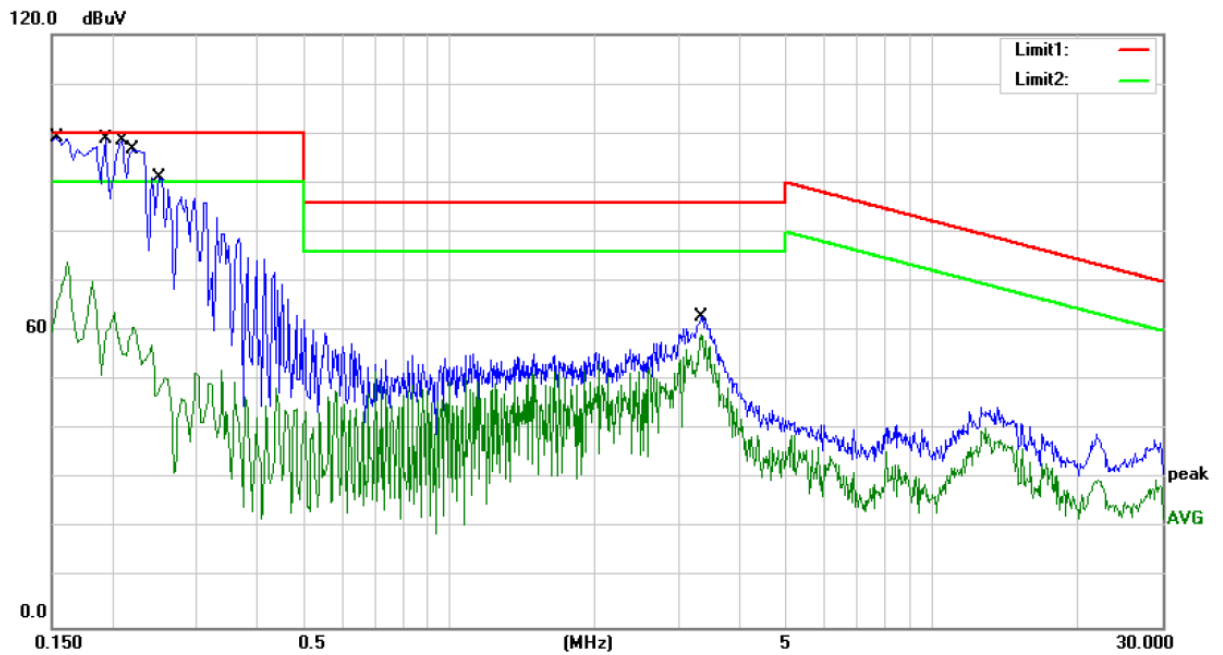

Site Conduction #2 Phase: **N** Temperature: 21
 Limit: (CE)EN62040-2 C3_QP Power: AC 230V/50Hz Humidity: 53 %
 Mode: Bat MODE
 Note: Internal battery

No.	Mk.	Freq.	Reading Level	Correct Factor	Measurement	Limit	Over	Detector	Comment
		MHz	dBuV	dB	dBuV	dBuV	dB		
1		0.1540	78.18	9.62	87.80	100.00	-12.20	QP	
2		0.1540	64.42	9.62	74.04	90.00	-15.96	AVG	
3		0.1940	77.77	9.63	87.40	100.00	-12.60	QP	
4		0.1940	60.56	9.63	70.19	90.00	-19.81	AVG	
5		0.2100	79.07	9.63	88.70	100.00	-11.30	QP	
6		0.2100	54.18	9.63	63.81	90.00	-26.19	AVG	
7		0.2220	78.76	9.64	88.40	100.00	-11.60	QP	
8		0.2220	54.17	9.64	63.81	90.00	-26.19	AVG	
9	*	0.2500	81.41	9.65	91.06	100.00	-8.94	QP	
10		0.2500	47.45	9.65	57.10	90.00	-32.90	AVG	
11		3.3420	53.07	9.86	62.93	86.00	-23.07	QP	
12		3.3420	49.28	9.86	59.14	76.00	-16.86	AVG	

*:Maximum data x:Over limit !:over margin Comment: Factor build in receiver. Operator: Stan

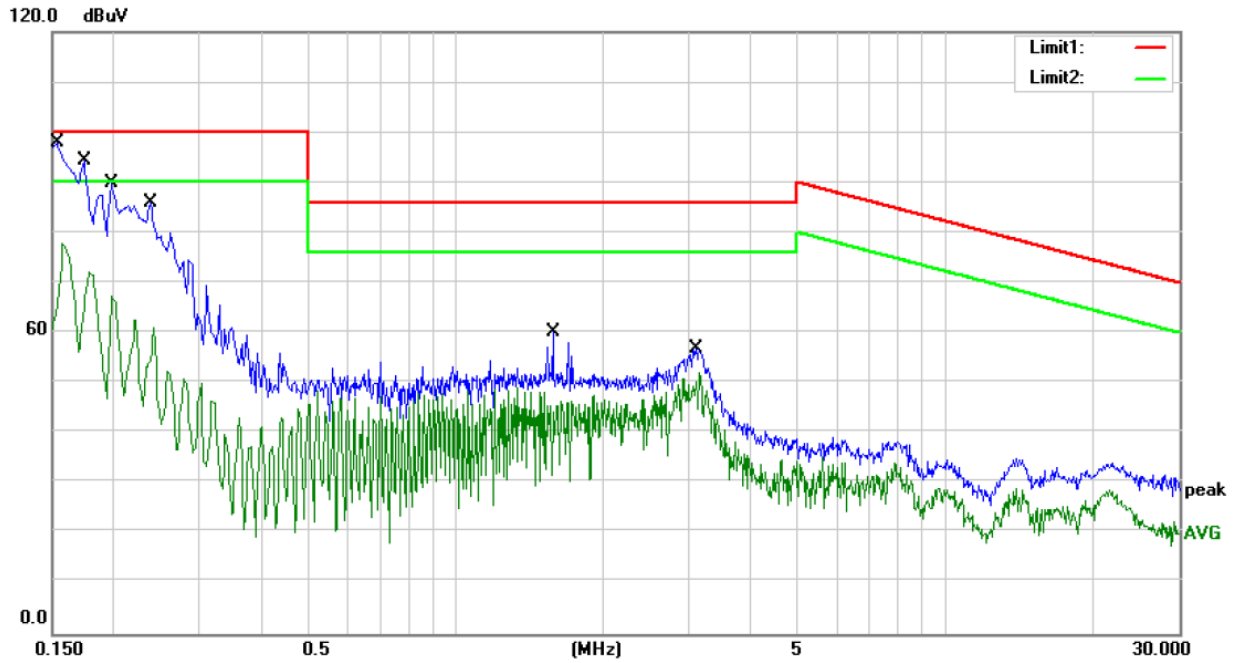

Site Conduction #2 Phase: **L1** Temperature: 21
 Limit: (CE)EN62040-2 C3_QP Power: AC 230V/50Hz Humidity: 53 %
 Mode: Bat MODE
 Note: External battery

No.	Mk.	Freq.	Reading Level	Correct Factor	Measurement	Limit	Over	Detector	Comment
		MHz	dBuV	dB	dBuV	dBuV	dB		
1	*	0.1540	88.98	9.62	98.60	100.00	-1.40	QP	
2		0.1540	68.11	9.62	77.73	90.00	-12.27	AVG	
3		0.1740	84.87	9.62	94.49	100.00	-5.51	QP	
4		0.1740	62.52	9.62	72.14	90.00	-17.86	AVG	
5		0.1980	80.20	9.63	89.83	100.00	-10.17	QP	
6		0.1980	57.67	9.63	67.30	90.00	-22.70	AVG	
7		0.2380	76.30	9.64	85.94	100.00	-14.06	QP	
8		0.2380	51.52	9.64	61.16	90.00	-28.84	AVG	
9		1.5820	50.39	9.85	60.24	86.00	-25.76	QP	
10		1.5820	38.40	9.85	48.25	76.00	-27.75	AVG	
11		3.1020	46.99	9.86	56.85	86.00	-29.15	QP	
12		3.1020	42.14	9.86	52.00	76.00	-24.00	AVG	

*:Maximum data x:Over limit !:over margin Comment: Factor build in receiver. Operator: Stan

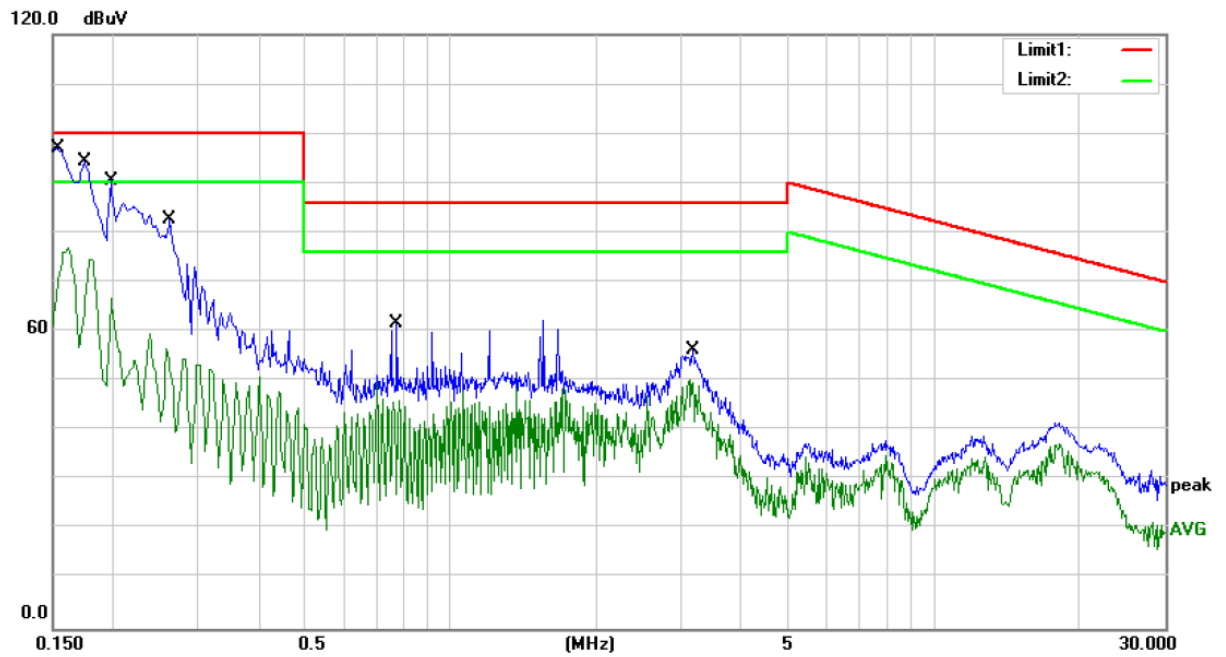

Site Conduction #2 Phase: **N** Temperature: 21
 Limit: (CE)EN62040-2 C3_QP Power: AC 230V/50Hz Humidity: 53 %
 Mode: Bat MODE
 Note: External battery

No.	Mk.	Freq.	Reading Level	Correct Factor	Measurement	Limit	Over	Detector	Comment
		MHz	dBuV	dB	dBuV	dBuV	dB		
1	*	0.1540	87.88	9.62	97.50	100.00	-2.50	QP	
2		0.1540	67.22	9.62	76.84	90.00	-13.16	AVG	
3		0.1740	84.77	9.62	94.39	100.00	-5.61	QP	
4		0.1740	64.92	9.62	74.54	90.00	-15.46	AVG	
5		0.1980	80.71	9.63	90.34	100.00	-9.66	QP	
6		0.1980	57.02	9.63	66.65	90.00	-23.35	AVG	
7		0.2620	72.92	9.65	82.57	100.00	-17.43	QP	
8		0.2620	46.83	9.65	56.48	90.00	-33.52	AVG	
9		0.7740	51.76	9.79	61.55	86.00	-24.45	QP	
10		0.7740	36.67	9.79	46.46	76.00	-29.54	AVG	
11		3.1620	46.33	9.86	56.19	86.00	-29.81	QP	
12		3.1620	40.30	9.86	50.16	76.00	-25.84	AVG	

*:Maximum data x:Over limit !:over margin Comment: Factor build in receiver. Operator: Stan

5. RADIATED EMISSION MEASUREMENT

5.1. Block Diagram of Test

5.1.1. Block diagram of connection between the EUT and simulators



(EUT: Uninterruptible Power Systems)

5.1.2. Block diagram of test setup (In chamber)

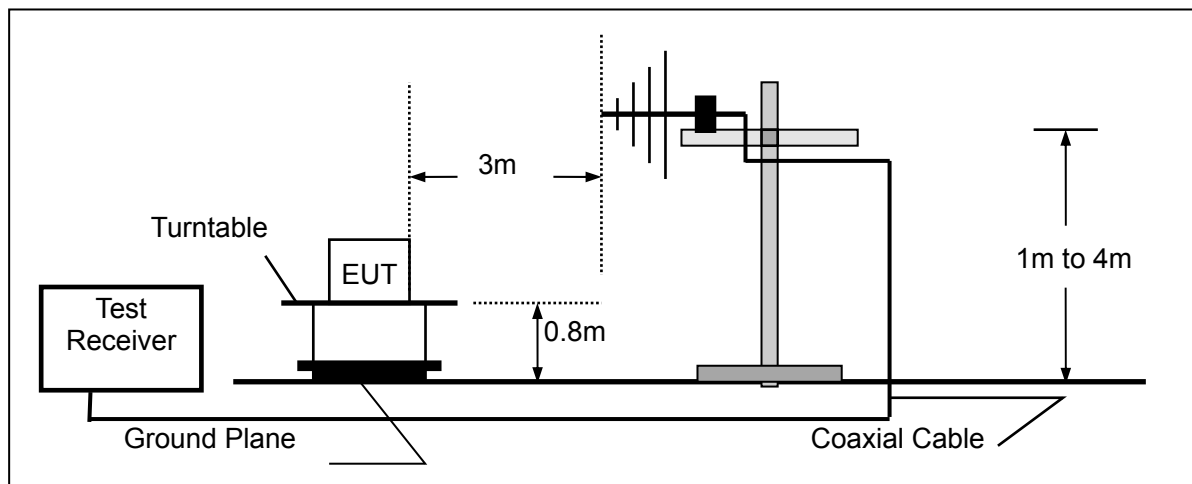

(EUT: Uninterruptible Power Systems)

5.2. Measuring Standard

EN62040-2: 2006 Category C3

5.3. Radiated Emission Limits(C3)

All emanations from a C3 device or system, including any network of conductors and apparatus connected thereto, shall not exceed the level of field strengths specified below:

FREQUENCY (MHz)	DISTANCE (Meters)	FIELD STRENGTHS LIMIT (dB μ V/m)
30 ~ 230	3	60
230 ~ 1000	3	67

Note: (1) The smaller limit shall apply at the combination point between two frequency bands.
(2) Distance refers to the distance in meters between the measuring instrument antenna and the closed point of any part of the EUT.

5.4. EUT Configuration on Test

The EN 62040-2 regulations test method must be used to find the maximum emission during radiated emission measurement.

5.5. Operating Condition of EUT

5.5.1. Turn on the power.

5.5.2. After that, let the EUT work in test mode (Line mode, Bat mode) and measure it.

5.6. Test Procedure

The EUT is placed on a turn table which is 0.8 meter high above the ground. The turn table can rotate 360 degrees to determine the position of the maximum emission level. The EUT is set 3 meters away from the receiving antenna which is mounted on an antenna tower. The antenna can be moved up and down from 1 to 4 meters to find out the maximum emission level. Bilog antenna (calibrated by Dipole Antenna) is used as a receiving antenna. Both horizontal and vertical polarization of the antenna are set on test.

The bandwidth of the Receiver is set at 120kHz.

All the modes were tested and the data of the worsted mode (Line mode) are attached in the following pages.

5.7. Measuring Results

PASS.

The frequency range from 30MHz to 1000MHz is investigated.

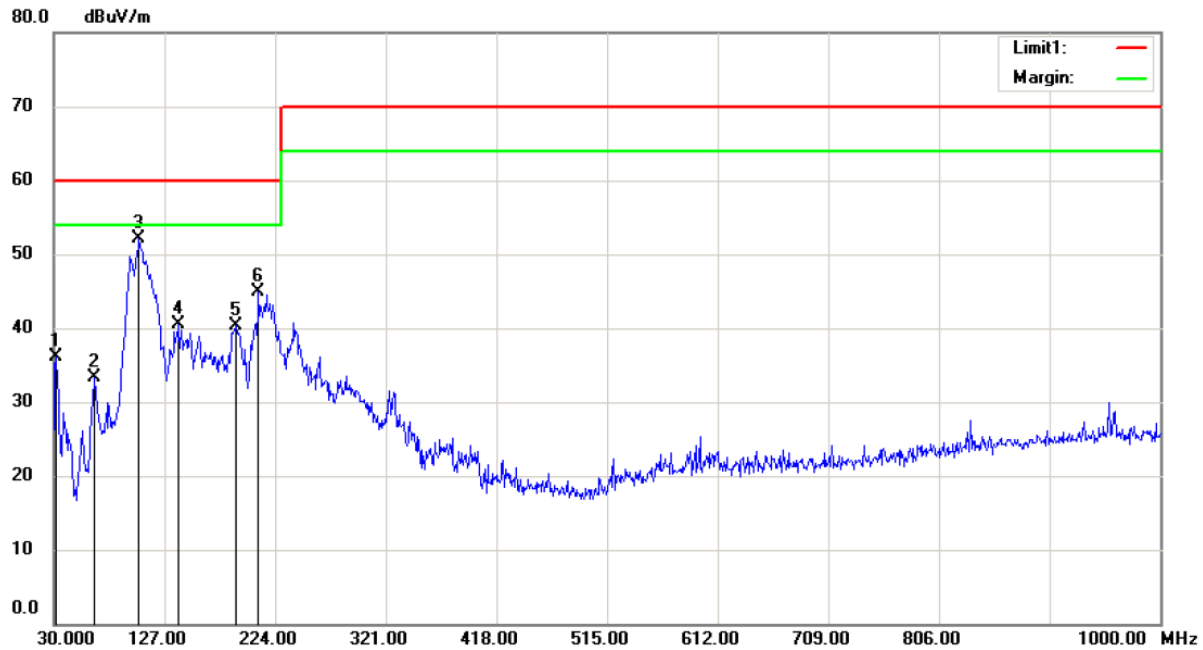

Site 3m Chamber #2

Polarization: *Horizontal*

Temperature: 22 C

Limit: EN62040-2 C3 3M

Power: AC 230V/50Hz

Humidity: 55 %

Mode: Line Mode

Note: Internal battery

No.	Mk.	Freq.	Reading	Correct	Measure-	Limit	Over	Antenna	Table	
		MHz	Level	Factor	ment			Height	Degree	Comment
			dBuV	dB	dBuV/m	dBuV/m	dB	cm	degree	
1		31.9400	53.44	-17.28	36.16	60.00	-23.84	QP		
2		65.8900	49.11	-15.89	33.22	60.00	-26.78	QP		
3	*	104.6900	66.77	-14.69	52.08	60.00	-7.92	QP		
4		139.6100	58.73	-18.25	40.48	60.00	-19.52	QP		
5		190.0500	56.15	-15.92	40.23	60.00	-19.77	QP		
6		209.4500	59.61	-14.74	44.87	60.00	-15.13	QP		

*:Maximum data x:Over limit !:over margin

Operator:

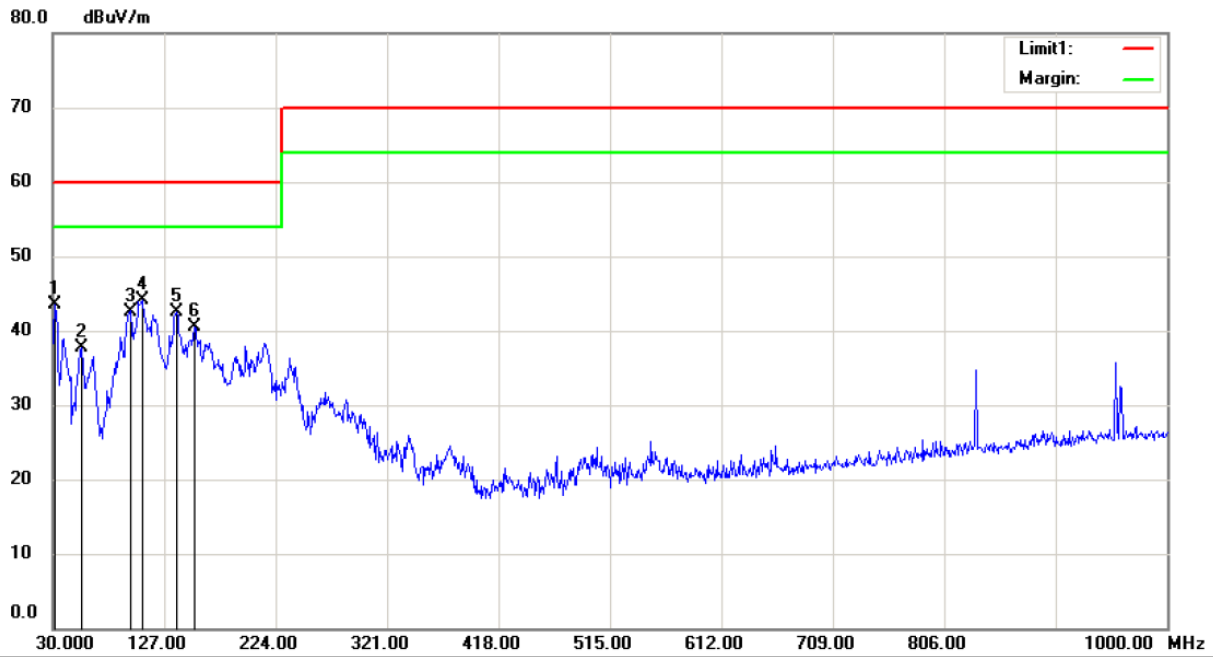

Site 3m Chamber #2

Polarization: *Vertical*

Temperature: 22 C

Limit: EN62040-2 C3 3M

Power: AC 230V/50Hz

Humidity: 55 %

Mode: Line Mode

Note: Internal battery

No.	Mk.	Freq.	Reading Level	Correct Factor	Measurement	Limit	Over	Antenna Height	Table Degree	
		MHz	dBuV	dB	dBuV/m	dBuV/m	dB	cm	degree	Comment
1		31.9400	60.80	-17.28	43.52	60.00	-16.48			QP
2		55.2200	51.92	-14.20	37.72	60.00	-22.28			QP
3		97.9000	57.52	-14.92	42.60	60.00	-17.40			QP
4	*	107.6000	59.00	-14.90	44.10	60.00	-15.90			QP
5		137.6700	60.75	-18.19	42.56	60.00	-17.44			QP
6		153.1900	58.59	-18.05	40.54	60.00	-19.46			QP

*:Maximum data x:Over limit !:over margin

Operator:

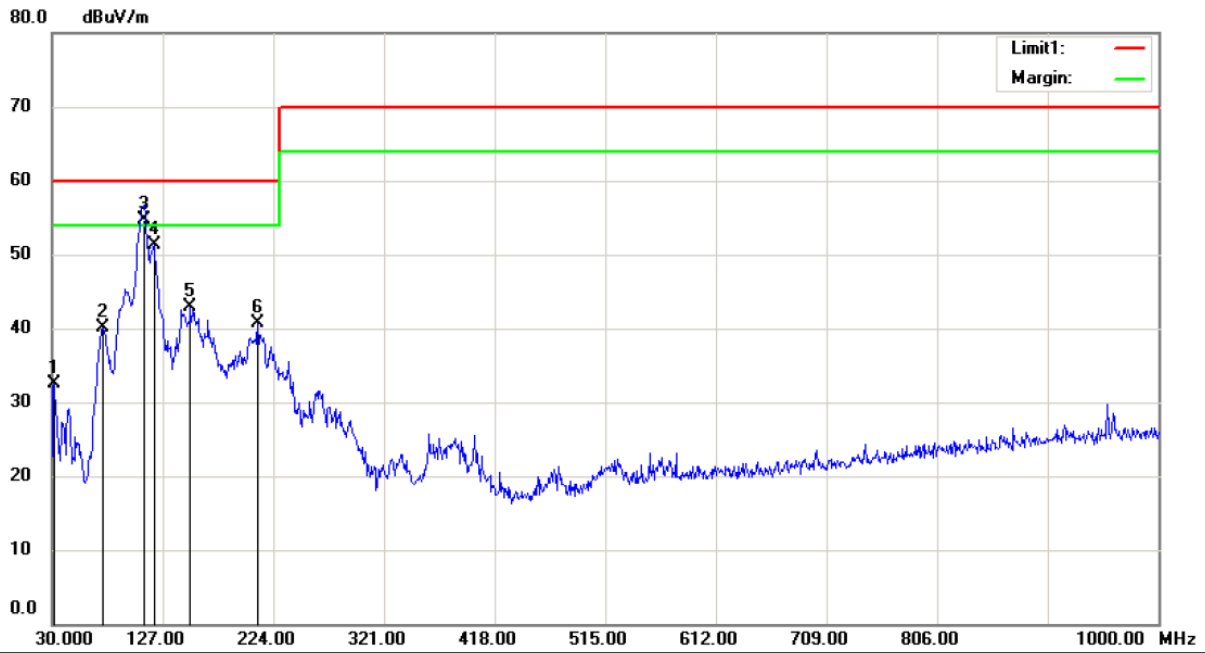

Site 3m Chamber #2

Polarization: *Horizontal*

Temperature: 22 C

Limit: EN62040-2 C3 3M

Power: AC 230V/50Hz

Humidity: 55 %

Mode: Line Mode

Note: External battery

No.	Mk.	Freq. MHz	Reading Level dBuV	Correct Factor dB	Measure- ment dBuV/m	Limit dBuV/m	Over dB	Antenna Height cm	Table Degree	Comment
1		31.9400	49.73	-17.28	32.45	60.00	-27.55	QP		
2		74.6200	58.38	-18.20	40.18	60.00	-19.82	QP		
3	*	110.5100	69.83	-15.13	54.70	60.00	-5.30	QP		
4		119.2400	67.61	-16.21	51.40	60.00	-8.60	QP		
5		151.2500	61.12	-18.14	42.98	60.00	-17.02	QP		
6		210.4200	55.27	-14.65	40.62	60.00	-19.38	QP		

*:Maximum data x:Over limit !:over margin

Operator:

6. IMMUNITY PERFORMANCE CRITERIA DESCRIPTION

Performance Level

The test results shall be classified in terms of the loss of function or degradation of performance of the equipment under test, relative to a performance level by its manufacturer or the requestor of the test, or the agreed between the manufacturer and the purchaser of the product.

Definition related to the performance level:

1. Based on the used product standard
2. Based on the declaration of the manufacturer, requestor or purchaser

Criterion A:

Definition: normal performance within limits specified by the manufacturer, requestor and purchaser.

The equipment shall continue to operate as intended without operator intervention. No degradation of performance or loss of function is allowed below a performance level specified by the manufacturer when the equipment is used as intended. The performance level may be replaced by a permissible loss of performance. If the minimum performance level or the permissible performance loss is not specified by the manufacturer, then either of these may be derived from the product description and documentation, and by what the user may reasonably expect from the equipment if used as intended.

Criterion B:

Definition: temporary loss of function or degradation of performance which ceases after the disturbance ceases, and from which the equipment under test recovers its normal performance, without operator intervention.

After the test, the EUT shall continue to operate as intended without operator intervention. No degradation of performance or loss of function is allowed, after the application of the phenomena below a performance level specified by the manufacturer, when the EUT is used as intended. The performance level may be replaced by a permissible loss of performance. During the test, degradation of performance is allowed. However, no change of operating state or stored data is allowed to persist after the test. If the minimum performance level (or the permissible performance loss) is not specified by the manufacturer, then either of these may be derived from the product description and documentation, and by what the user may reasonably expect from the EUT if used as intended.

Criterion C:

Definition: temporary loss of function or degradation of performance, the correction of which requires operator intervention.

Loss of function is allowed, provided the function is self-recoverable, or can be restored by the operation of the controls by the user in accordance with the manufacturer's instructions. Functions, and/or information stored in non-volatile memory, or protected by a battery backup, shall not be lost.

Criterion D

Definition: loss of function or degradation of performance, which is not recoverable, owing to damage to hardware or software, or loss of data.

7. ELECTROSTATIC DISCHARGE IMMUNITY TEST

7.1. Block Diagram of Test Setup

7.1.1. Block diagram of connection between the EUT and simulators

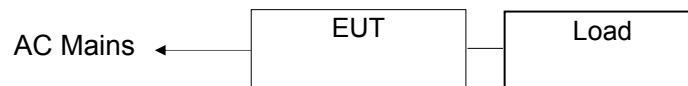

(EUT: Uninterruptible Power Systems)

7.1.2. Block diagram of ESD test setup

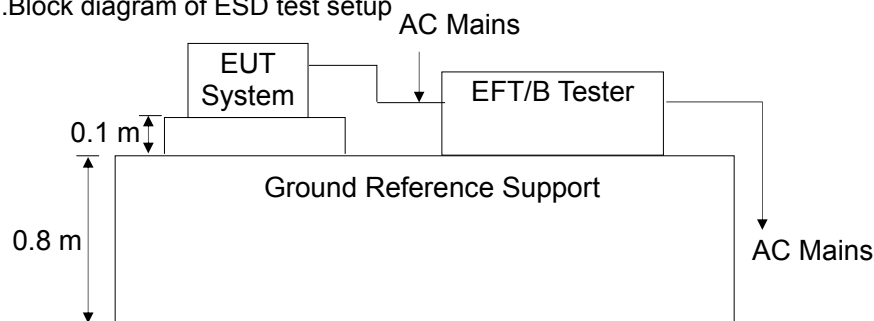

(EUT: Uninterruptible Power Systems)

7.2. Test Standard

IEC 61000-4-2:2008 (Air Discharge: ± 8 kV, Contact Discharge: ± 4 kV)

7.3. Severity Levels and Performance Criterion

7.3.1. Severity level

Level	Test Voltage Contact Discharge (kV)	Test Voltage Air Discharge (kV)
1.	± 2	± 2
2.	± 4	± 4
3.	± 6	± 8
4.	± 8	± 15
X	Special	Special

7.3.2.Performance criterion : B

	Criterion B
Output characteristics	Voltage permitted to vary within the inverse time characteristics applicable (<100 m sec limits in Figures 1, 2 or 3 of IEC 62040-3)
External and internal indications and metering	Change only during test
Control signals to external devices	Change only temporarily in consistency with the actual Uninterruptible Power Systems mode of operation
Mode of operation	Change only temporarily

7.4. EUT Configuration

The configuration of EUT are listed in Section 4.3.

7.5. Operating Condition of EUT

Same as conducted emission measurement, which is listed in Section 4.4. except the test set up replaced by Section 9.1.

7.6. Test Procedure

7.6.1.Air Discharge:

This test is done on a non-conductive surface. The round discharge tip of the discharge electrode shall be approached as fast as possible to touch the EUT. After each discharge, the discharge electrode shall be removed from the EUT. The generator is then re-triggered for a new single discharge and repeated 10 times for each pre-selected test point. This procedure shall be repeated until all the air discharge completed

7.6.2.Contact Discharge:

All procedure shall be the same as Section 9.6.1. except that the tip of the discharge electrode shall touch the EUT before the discharge switch is operated.

7.6.3.Indirect discharge for horizontal coupling plane

At least 10 single discharges(in the most sensitive polarity) shall be applied at the front edge of each HCP opposite the center point of each unit(if applicable) of the EUT and 0.1m from the front of the EUT. The long axis of the discharge electrode shall be in the plane of the HCP and perpendicular to its front edge during the discharge.

7.6.4.Indirect discharge for vertical coupling plane

At least 10 single discharge (in the most sensitive polarity) shall be applied to the center of one vertical edge of the coupling plane. The coupling plane, of dimensions 0.5m X 0.5m, is placed parallel to, and positioned at a distance of 0.1m from the EUT. Discharges shall be applied to the coupling plane, with this plane in sufficient different positions that the four faces of the EUT are completely illuminated.

7.7. Test Results

PASS

Please refer to the following page.

Electrostatic Discharge Test Result

EMTEK(SHENZHEN) CO., LTD.

Applicant : INVT POWER SYSTEM(SHENZHEN) CO., LTD <hr/> EUT : Uninterruptible Power Systems <hr/> M/N : HR1110XL <hr/> Power Supply : AC 230V/50Hz <hr/> Test Mode : Line mode, Bat mode <hr/> Test Engineer : ZCJ	Test Date : March 28, 2017 <hr/> Temperature : 22°C <hr/> Humidity : 50% <hr/> Actual Criterion : B <hr/> Air discharge : ±8kV <hr/> Contact discharge : ±4kV	
Location	Kind A-Air Discharge C-Contact Discharge	Result
Slot	A	A
Screw	C	A
Metal	C	A
HCP	C	A
VCP of front	C	A
VCP of rear	C	A
VCP of left	C	A
VCP of right	C	A
Test Equipment: ESD Simulator (TESEQAG, NSG 437)		

8. RF FIELD STRENGTH SUSCEPTIBILITY TEST

8.1. Block Diagram of Test

8.1.1. Block diagram of connection between the EUT and Load



(EUT: Uninterruptible Power Systems)

8.1.2. Block diagram of RS test setup

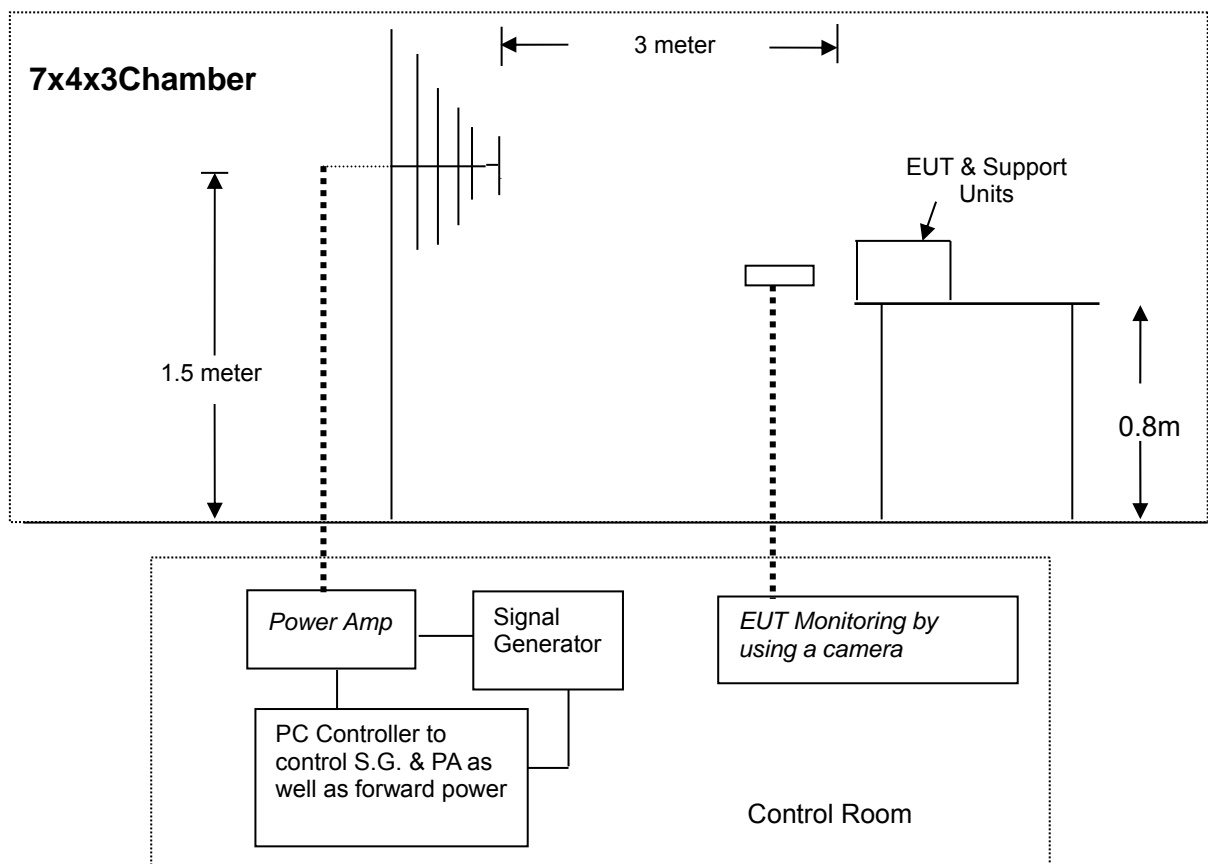

(EUT: Uninterruptible Power Systems)

8.2. Test Standard

IEC 61000-4-3:2006+A1:2007+A2:2010 (level 3: 10V / m)

8.3. Severity Levels and Performance Criterion

8.3.1. Severity Levels

Level	Field Strength V/m
1.	1
2.	3
3.	10
X	Special

8.3.2. Performance Criterion : A

	Criterion A
External and internal indications and metering (LCD)	No change
Output characteristics (Load)	No change
Control signals to external devices (Signal line)	No change
Mode of operation	No change

8.4. EUT Configuration on Test

The configuration of the EUT is same as Section 4.3.

8.5. Operating Condition of EUT

Same as radiated emission measurement which is listed in Section 4.4, except the test setup replaced as Section 10.1.

8.6. Test Procedure

The EUT is placed on a table which is 0.8m high above the ground. The EUT is set 3 meters away from the transmitting antenna which is mounted on an antenna tower. Both horizontal and vertical polarization of the antenna are set on test. Each of the four sides of the EUT must be faced this transmitting antenna and measured individually.

In order to judge the EUT performance, a CCD camera is used to monitor its screen. All the scanning conditions are as following:

Condition of Test	Remark
1. Fielded Strength	10V/m(level 3)
2. Radiated Signal	Modulated
3. Scanning Frequency	80-1000MHz
4. Sweep time of radiated	0.0015 Decade/s
5. Dwell Time	1 Sec.

8.7. Test Results

PASS.

Please refer to the following page.

RF Field Strength Susceptibility Test Results

EMTEK (SHENZHEN) CO., LTD.

<p>Applicant : INVT POWER SYSTEM(SHENZHEN) CO., LTD</p> <hr/> <p>EUT : Uninterruptible Power Systems</p> <hr/> <p>M/N : HR1110XL</p> <hr/> <p>Field Strength : 10V/m</p> <hr/> <p>Power Supply : AC 230V/50Hz</p> <hr/> <p>Test Engineer : ZCJ</p> <hr/>	<p>Test Date : March 28, 2017</p> <hr/> <p>Temperature : 22°C</p> <hr/> <p>Humidity : 50%</p> <hr/> <p>Actual Criterion : A</p> <hr/> <p>Test Mode : Line mode, Bat mode</p> <hr/> <p>Frequency Range : 80 to 1000 MHz</p> <hr/>		
<p>Modulation: <input type="checkbox"/>None <input type="checkbox"/>Pulse <input checked="" type="checkbox"/>AM 1KHz 80%</p>			
<p>Frequency Rang 1: 80~ 1000MHz</p>			
<p>Frequency Rang 2: N/A</p>			
Steps	# / %	# / %	# / %
	Horizontal	Vertical	Horizontal
Front	A	A	
Right	A	A	
Rear	A	A	
Left	A	A	
<p>Test Equipment :</p> <p>1. Signal Generator : N5181A (Agilent)</p> <p>2. Power Amplifier : 80RF1000-175 (MILMEGA) & AS1860-50 (MILMEGA)</p> <p>3. Log.-Per.Antenna: VULP9118E (SCHWARZBECK)</p> <p>4 RF Power Meter. Dual Channel: 4232A (BOONTON)</p> <p>5 Field Strength Meter: RSS1006A (DARE)</p>			
<p>Note: /</p>			

9. ELECTRICAL FAST TRANSIENT/BURST IMMUNITY TEST

9.1. Block Diagram of Test Setup

9.1.1. Block Diagram of the EUT



(EUT: Uninterruptible Power Systems)

9.1.2. EFT Test Setup

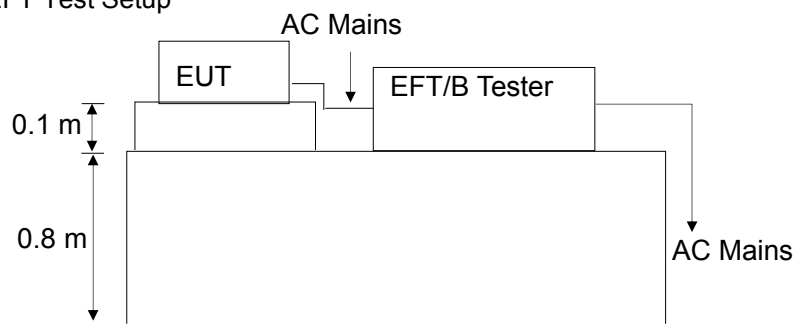

(EUT: Uninterruptible Power Systems)

9.2. Test Standard

IEC 61000-4-4:2012 (Level 3: 2KV/5kHz for AC Mains)

9.3. Severity Levels and Performance Criterion

9.3.1. Severity level

Open Circuit Output Test Voltage $\pm 10\%$		
Level	On Power Supply Lines	On I/O (Input/Output) Signal data and control lines
1.	0.5 kV	0.25 kV
2.	1 kV	0.5 kV
3.	2 kV	1 kV
4.	4 kV	2 kV
X	Special	Special

9.3.2. Performance criterion : B

Criterion B	
Output characteristics	Voltage permitted to vary within the inverse time characteristics applicable (< 100 m sec limits in Figures 1, 2 or 3 of IEC 62040-3)
External and internal indications and metering	Change only during test
Control signals to external devices	Change only temporarily in consistency with the actual Uninterruptible Power Systems mode of operation
Mode of operation	Change only temporarily

9.4. EUT Configuration

The configuration of EUT is listed in Section 4.4.

9.5. Operating Condition of EUT

9.5.1. Setup the EUT as shown in Section 9.1.

9.5.2. Turn on the power of all equipment.

9.5.3. Let the EUT work in test mode (Line mode) and measure it.

9.6. Test Procedure

The EUT is put on the table which is 0.8m high above the ground. This reference ground plane shall project beyond the EUT by at least 0.1m on all sides and the minimum distance between EUT and all other conductive structure, except the ground plane beneath the EUT, shall be more than 0.5m.

9.6.1. For input and output AC power ports:

The EUT is connected to the power mains by using a coupling device which couples the EFT interference signal to AC power lines. Both polarities of the test voltage should be applied during compliance test and the duration of the test is 2 mins.

9.6.2. For signal line and control lines ports:

It's unnecessary to test.

9.6.3. For DC output line ports:

It's unnecessary to test.

9.7. Test Result

PASS.

Please refer to the following page.

Electrical Fast Transient/Burst Test Results

EMTEK (SHENZHEN) CO., LTD.

Standard	IEC 61000-4-4	Result: <input checked="" type="checkbox"/> PASS / <input type="checkbox"/> FAIL	
Applicant : <u>INVT POWER SYSTEM(SHENZHEN) CO., LTD</u> EUT : <u>Uninterruptible Power Systems</u> M/N : <u>HR1110XL</u> Input Voltage : <u>AC 230V/50Hz</u> Actual Criterion : <u>B</u> Ambient Condition : <u>23 °C</u> <u>55% RH</u>			
Operation Mode: Line mode			
Line : <input checked="" type="checkbox"/> AC input and output power ports		Line : <input type="checkbox"/> Signal <input type="checkbox"/> I/O Cable	
Coupling : <input checked="" type="checkbox"/> Direct		Coupling : <input type="checkbox"/> Capacitive	
Test Time : 120s			
Line	Test Voltage	Result(+)	Result(-)
L	2kV	A	A
N	2kV	A	A
PE	2kV	A	A
L、N	2kV	A	A
L、PE	2kV	A	A
N、PE	2kV	A	A
L、N、PE	2kV	A	A
DC line			
Signal line			
Note:			
Test Equipment		Burst Tester Model : PEFT 4010	

10. SURGE IMMUNITY TEST

10.1. Block Diagram of Test Setup

10.1.1. Block Diagram of the EUT



(EUT: Uninterruptible Power Systems)

10.1.2. Surge Test Setup

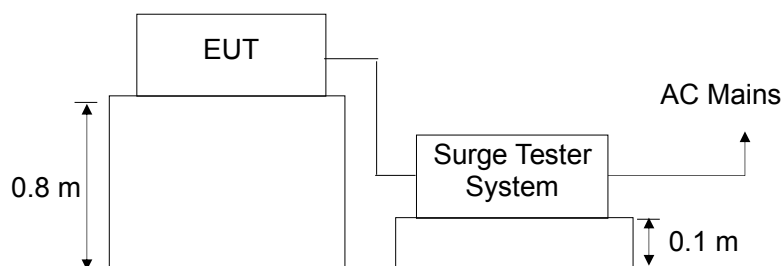

(EUT: Uninterruptible Power Systems)

10.2. Test Standard

IEC 61000-4-5:2014 (Line to Line: Level 2, 1.0kV, Line to earth: Level 3, 2.0kV)

10.3. Severity Levels and Performance Criterion

10.3.1. Severity level

Severity Level	Open-Circuit Test Voltage kV
1	0.5
2	1.0
3	2.0
4	4.0
*	Special

10.3.2. Performance criterion: B

	Criterion B
Output characteristics	Voltage permitted to vary within the inverse time characteristics applicable (<100 m sec limits in Figures 1, 2 or 3 of IEC 62040-3)
External and internal indications and metering	Change only during test
Control signals to external devices	Change only temporarily in consistency with the actual Uninterruptible Power Systems mode of operation
Mode of operation	Change only temporarily

10.4.EUT Configuration

The configuration of EUT is listed in Section 4.3.

10.5.Operating Condition of EUT

10.5.1.Setup the EUT as shown in Section 12.1.

10.5.2.Turn on the power of all equipment.

10.5.3.Let the EUT work in test mode (Line mode) and measure it.

10.6.Test Procedure

- 1) Set up the EUT and test generator as shown on Section 10.1.2.
For line to line coupling mode, provide 1kV 1.2/50us voltage surge.
For line to earth coupling mode, provide 2kV 1.2/50us voltage surge.
(At open-circuit condition) and 8/20us current surge to EUT selected points.
- 2) At least 5 positive and 5 negative (polarity) tests with a maximum 1/min repetition rate are conducted during test.
- 3) Different phase angles are done individually.
- 4) Record the EUT operating situation during compliance test and decide the EUT immunity criterion for above each test.

10.7.Test Result

PASS.

Please refer to the following page.

Surge Immunity Test Result

EMTEK (SHENZHEN) CO., LTD.

Applicant : INVT POWER SYSTEM(SHENZHEN) CO., LTD

Test Engineer: ZCJ

EUT : Uninterruptible Power Systems

Test Date : March 28, 2017

M/N : HR1110XL

Temperature : 23°C

Power Supply : AC 230V / 50Hz

Humidity : 51%

Test Mode : Line mode

Criterion : B

Location	Polarity	Phase Angle	Number of Pulse	Pulse Voltage (kV)	Result
AC input power ports: L-N	+	0°, 90°, 180°, 270°	5	1.0	A
	-	0°, 90°, 180°, 270°	5	1.0	A
L-PE	+	0°, 90°, 180°, 270°	5	2.0	A
	-	0°, 90°, 180°, 270°	5	2.0	A
N-PE	+	0°, 90°, 180°, 270°	5	2.0	A
	-	0°, 90°, 180°, 270°	5	2.0	A
AC output power ports: L-N	+	random	5	1.0	A
	-	random	5	1.0	A
L-PE	+	random	5	2.0	A
	-	random	5	2.0	A
N-PE	+	random	5	2.0	A
	-	random	5	2.0	A

Note:

11. INJECTED CURRENTS SUSCEPTIBILITY TEST

11.1. Block Diagram of Test Setup

11.1.1. Block Diagram of the EUT



(EUT: Uninterruptible Power Systems)

11.1.2. Block Diagram of Test Setup

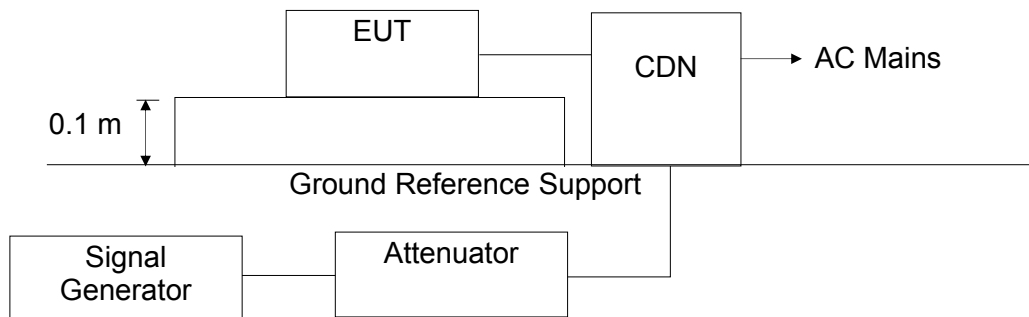

11.2. Test Standard

IEC 61000-4-6:2013 (Level 3: 10V (rms) (0.15MHz ~ 80MHz))

11.3. Severity Levels and Performance Criterion

11.3.1. Severity level

Level	Field Strength V
1	1
2	3
3	10
X	Special

11.3.2. Performance criterion: A

	Criterion A
External and internal indications and metering (LCD)	No change
Output characteristics (Load)	No change
Control signals to external devices (Signal line)	No change
Mode of operation	No change

11.4.EUT Configuration

The configuration of EUT is listed in Section 4.3.

11.5.Operating Condition of EUT

11.5.1.Setup the EUT as shown in Section 11.1.

11.5.2.Turn on the power of all equipment.

11.5.3.Let the EUT work in test mode (Line mode) and measure it.

11.6.Test Procedure

- 1) Set up the EUT, CDN and test generators as shown on Section 11.1.2.
- 2) Let the EUT work in test mode and measure it.
- 3) The EUT are placed on an insulating support 0.1m high above a ground reference plane. CDN (coupling and decoupling device) is placed on the ground plane about 0.3m from EUT. Cables between CDN and EUT are as short as possible, and their height above the ground reference plane shall be between 30 and 50 mm (where possible).
- 4) The disturbance signal described below is injected to EUT through CDN.
- 5) The EUT operates within its operational mode(s) under intended climatic conditions after power on.
- 6) The frequency range is swept from 150KHz to80MHz using 10V signal level, and with the disturbance signal 80% amplitude modulated with a 1KHz sine wave.
- 7) The rate of sweep shall not exceed $1.5 \cdot 10^{-3}$ decades/s. Where the frequency is swept incrementally, the step size shall not exceed 1% of the start and thereafter 1% of the preceding frequency value.
- 8) Recording the EUT operating situation during compliance testing and decide the EUT immunity criterion.

11.7.Test Results

PASS.

Please refer to the following page.

Injected Currents Susceptibility Test Results

EMTEK (SHENZHEN) CO., LTD.

Applicant : <u>INVT POWER SYSTEM(SHENZHEN) CO., LTD</u>		Test Date : <u>March 28, 2017</u>		
EUT : <u>Uninterruptible Power Systems</u>		Temperature : <u>23°C</u>		
M/N : <u>HR1110XL</u>		Humidity : <u>50%</u>		
Power Supply : <u>AC 230V/50Hz</u>		Actual Criterion : <u>A</u>		
Test Engineer : <u>ZCJ</u>				
Test Mode : Line mode				
Frequency Range (MHz)	Injected Position	Strength (Unmodulated)	Criterion	Result
0.15 ~ 80	AC Input	10V	A	A
0.15 ~ 80	AC Output	10V	A	A
Remark : 1. Modulation Signal:1KHz 80% AM Measurement Equipment : Simulator: CWS 500C (SWITZERLAND EMTEST) CDN : <input type="checkbox"/> CDN-M2 (SWITZERLAND EMTEST) <input checked="" type="checkbox"/> CDN-M3 (SWITZERLAND EMTEST) <input type="checkbox"/> EM-Clamp (SWITZERLAND EMTEST)		Note: /		

12. MAGNETIC FIELD SUSCEPTIBILITY TEST

12.1. Block Diagram of Test

12.1.1. Block diagram of test setup

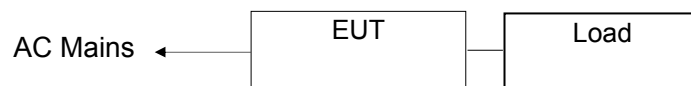

(EUT: Uninterruptible Power Systems)

12.1.2. Magnetic field test setup

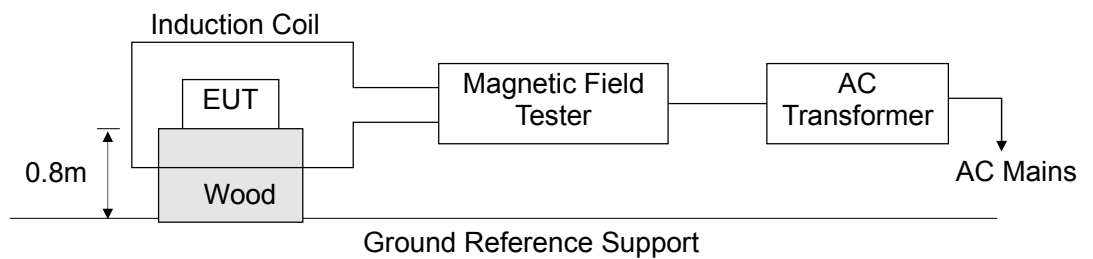

(EUT: Uninterruptible Power Systems)

12.2. Test Standard

IEC 61000-4-8:2009, (Severity Level 4: 30A / m)

12.3. Severity Levels and Performance Criterion

12.3.1. Severity Levels

Level	Field Strength A/m
1	1
2	3
3	10
4	30
5	100
X	Special

12.3.2.Performance Criterion: A

	Criterion A
Output characteristics	Voltage permitted to vary within the inverse time characteristics applicable (<100 m sec limits in Figures 1, 2 or 3 of IEC 62040-3)
External and internal indications and metering	Change only during test
Control signals to external devices	Change only temporarily in consistency with the actual Uninterruptible Power Systems mode of operation
Mode of operation	Change only temporarily

12.4.EUT Configuration on Test

The configuration of the EUT is same as Section 4.3.

12.5.Test Procedure

The EUT is placed in the middle of a induction coil, under which is a 0.8m (high) table, this small table is also placed on a larger table, 0.8 m above the ground. Both horizontal and vertical polarization of the induction coil is set on test, so that each side of the EUT is affected by the magnetic field. Also can reach the same aim by change the position of the EUT.

12.6.Test Results

PASS.

Please refer to the following page.

Magnetic Field Immunity Test Result

EMTEK (SHENZHEN) CO., LTD.

Standard	IEC 61000-4-8		Result: <input checked="" type="checkbox"/> Pass / <input type="checkbox"/> Fail	
<p>Applicant : <u>INVT POWER SYSTEM(SHENZHEN) CO., LTD</u></p> <p>EUT : <u>Uninterruptible Power Systems</u> M/N : <u>HR1110XL</u></p> <p>Input Voltage : <u>AC 230V/50Hz</u></p> <p>Date of Test : <u>March 28, 2017</u> Test Engineer : <u>ZCJ</u></p> <p>Ambient Condition : Temp : <u>22°C</u> Humid : <u>50%</u></p> <p>Actual Criterion : A</p>				
Operation Mode : Line mode				
Test Level (A/M)	Testing Duration	Coil Orientation	Criterion	Result
30	5 mins	X	A	A
30	5 mins	Y	A	A
30	5 mins	Z	A	A
Operation Mode : N/A				
Test Level (A/M)	Testing Duration	Coil Orientation	Criterion	Result
Test Equipment	Magnetic Field Test : HEAFELY MAG 100.1			
Note: /				

13. VOLTAGE DIPS AND INTERRUPTIONS TEST

13.1. Block Diagram of Test Setup

13.1.1. Block Diagram of the EUT

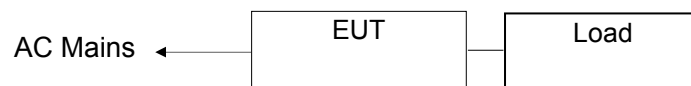

(EUT: Uninterruptible Power Systems)

13.1.2. Dips Test Setup

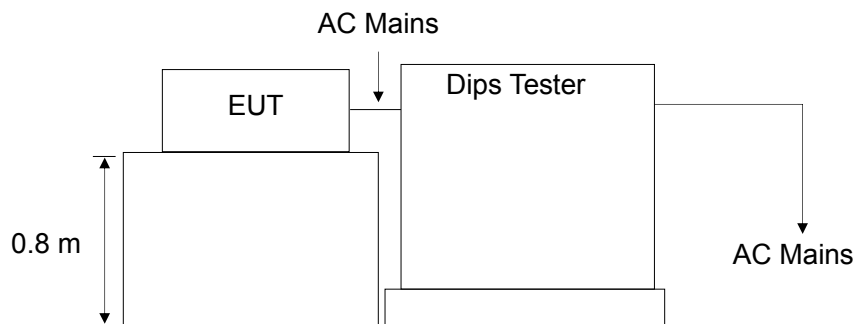

(EUT: Uninterruptible Power Systems)

13.2. Test Standard

IEC 61000-4-11:2004

13.3. Severity Levels and Performance Criterion

13.3.1. Severity level

Test Level %UT	Voltage dip and short interruptions %UT	Duration (in period)
0	100	0.5 1 5 10 25 50 *
40	60	
70	30	

13.3.2.Performance criterion: B

	Criterion B
Output characteristics	Voltage permitted to vary within the inverse time characteristics applicable (<100 m sec limits in Figures 1, 2 or 3 of IEC 62040-3)
External and internal indications and metering	Change only during test
Control signals to external devices	Change only temporarily in consistency with the actual Uninterruptible Power Systems mode of operation
Mode of operation	Change only temporarily

13.4.EUT Configuration

The configuration of EUT is listed in Section 4.3.

13.5.Operating Condition of EUT

13.5.1.Setup the EUT as shown in Section 13.1.

13.5.2.Turn on the power of all equipment.

13.5.3.Let the EUT work in test mode (Line mode) and measure it.

13.6.Test Procedure

- 1) Set up the EUT and test generator as shown on Section 13.1.2.
- 2) The interruption is introduced at selected phase angles with specified duration.
- 3) Record any degradation of performance.

13.7.Test Result

PASS.

Please refer to the following page.

Voltage Dips And Interruptions Test Results

EMTEK (SHENZHEN) CO., LTD.

Applicant : <u>INVT POWER SYSTEM(SHENZHEN) CO., LTD</u>		Test Date : <u>March 28, 2017</u>		
EUT : <u>Uninterruptible Power Systems</u>		Temperature : <u>22°C</u>		
M/N : <u>HR1110XL</u>		Humidity : <u>50%</u>		
Power Supply : <u>AC 230V/50Hz</u>		Test Engineer : <u>ZCJ</u>		
Test Mode: Line mode				
Test Level % U _T	Voltage Dips & Short Interruptions % U _T	Duration (in periods)	Criterion <input type="checkbox"/> A <input checked="" type="checkbox"/> B <input type="checkbox"/> C <input type="checkbox"/> D	Result
0	100	0.5P	B	A
0	100	1P	B	A
70	30	25P	B	A
0	100	250P	B	B
Note: Test in 0%, 250P, light appears flicker, but can self-recovery.				

14. LOW FREQUENCY SIGNALS TEST

14.1. Block Diagram of Test Setup

15.1.1 Block Diagram of the EUT

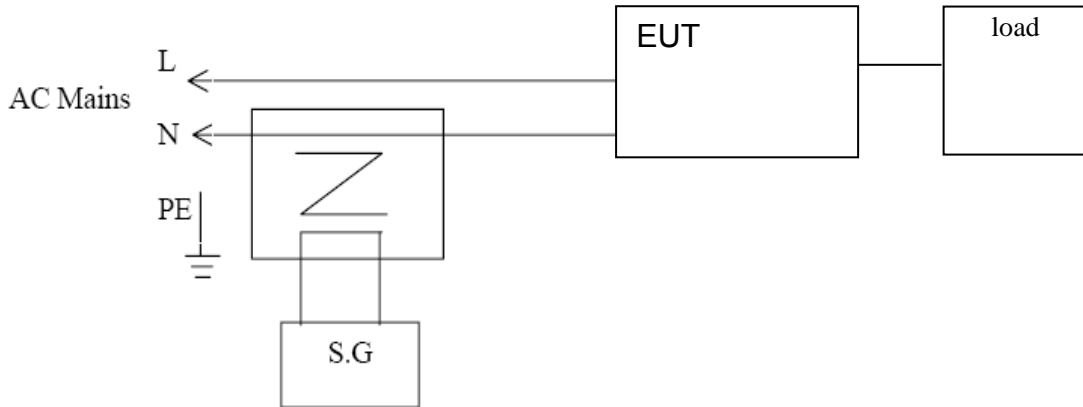

(EUT: Uninterruptible Power Systems)
Note: Above test setup is worst case by pretest.

14.2. Test Standard

IEC 61000-2-2:2002, Performance: A

	Criterion A
External and internal indications and metering (LCD)	No change
Output characteristics (Load)	No change
Control signals to external devices (Signal line)	No change
Mode of operation	No change

14.3. Operating Condition of EUT

Same as Section 4.4, Except the test setup replaced by Section 14.1.

14.4. Test Results

PASS.

Please refer to following page.

Low Frequency Signals Test Result

EMTEK (SHENZHEN) CO., LTD.

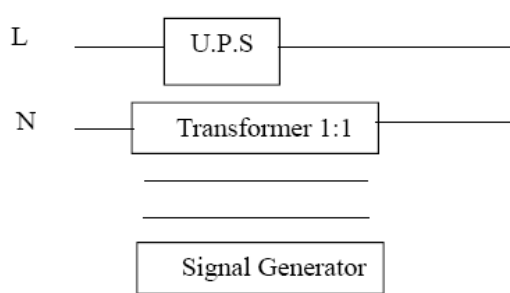
Applicant : <u>INVT POWER SYSTEM(SHENZHEN) CO., LTD</u> EUT : <u>Uninterruptible Power Systems</u> M/N : <u>HR1110XL</u> Power Supply : <u>AC 230V/50Hz</u> Test Engineer : <u>ZCJ</u>			Test Date : <u>March 28, 2017</u> Temperature : <u>22°C</u> Humidity : <u>58%</u> Test Mode : <u>Line mode</u> Actual Criterion : <u>A</u>	
Frequency Range (Hz)	Position	Strength	Result	Note
140	See Fig.1	10V(rms) Sinusoidal	A	/
160			A	/
200			A	/
240			A	/
280			A	/
320			A	/
360			A	/
Note  <pre> graph LR L --- UPS[U.P.S.] N --- T[Transformer 1:1] UPS --- T T --- SG[Signal Generator] </pre>			Test Equipment: 1. Isolation transformer Primary: Secondary=1:1 2. Signal Generator AC Source: 6530(Chroma)	

15. TEST PHOTOGRAPHS

15.1. Photos of Conducted Emission Measurement

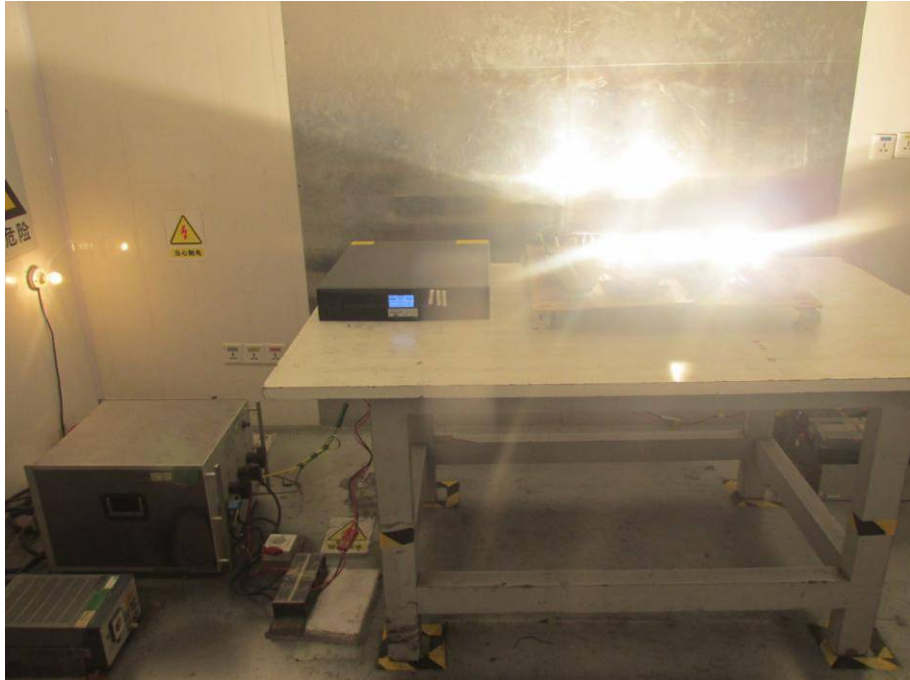

15.2.Photos of Radiation Emission Measurement

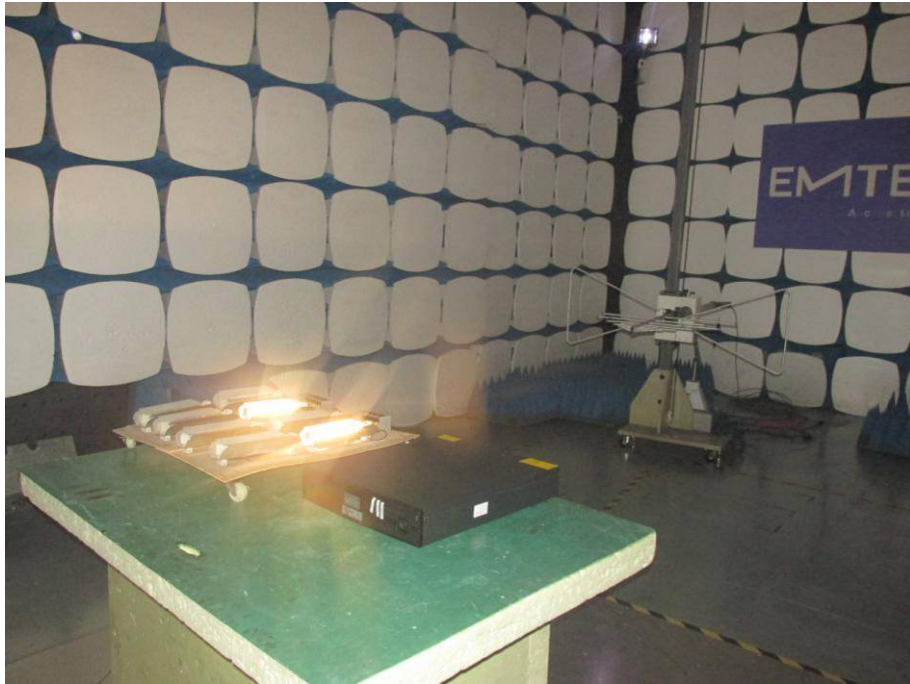

15.3. Photo of Electrostatic Discharge Test

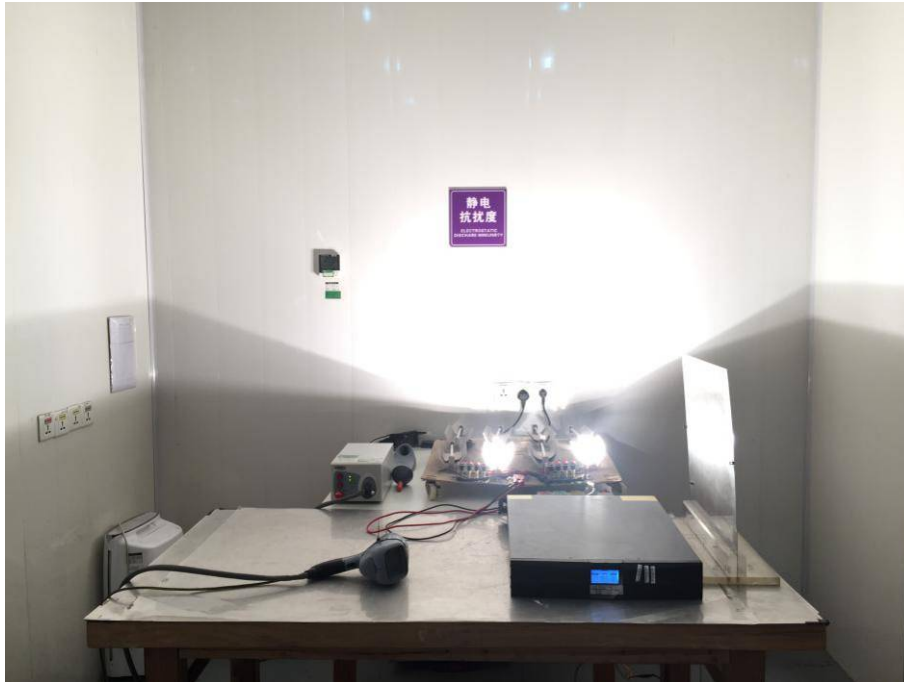

15.4. Photo of RF Field Strength susceptibility Test



15.5.Photos of Electrical Fast Transient/Burst Test



15.6.Photo of Surge Test



15.7. Photo of Injected Currents Susceptibility Test



15.8. Photo of Magnetic Field Immunity Test

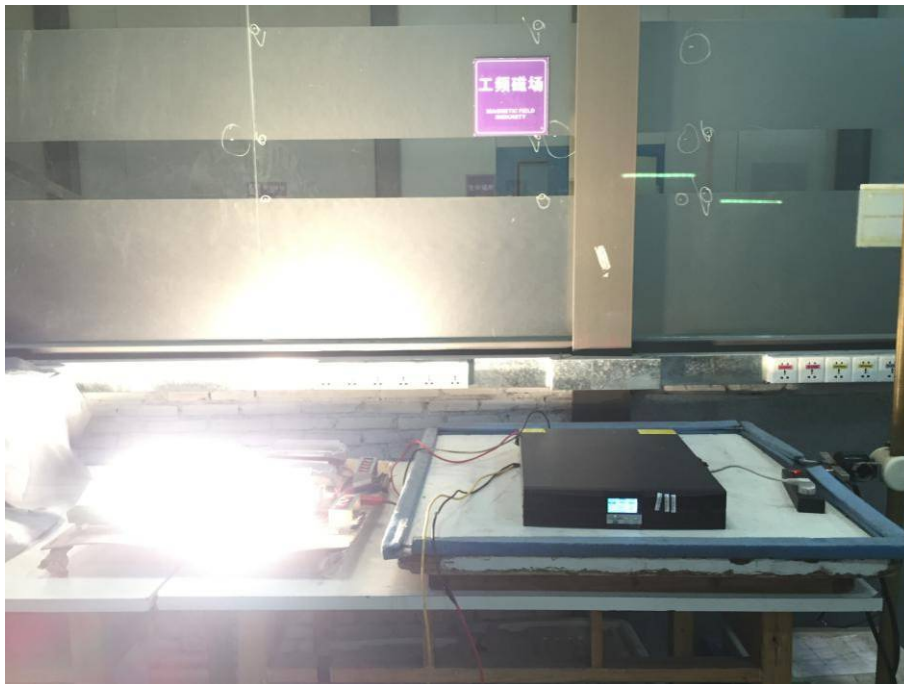

15.9. Photo of Voltage dips and interruption Test



15.10. Photo of Low Frequency Signals Test



APPENDIX (Photos of EUT)

Internal battery



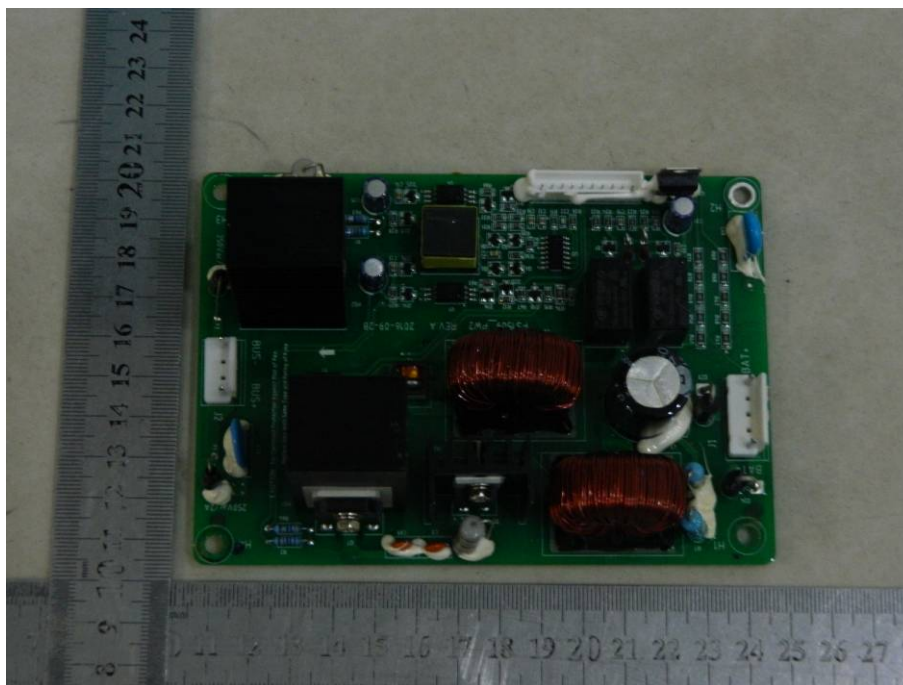

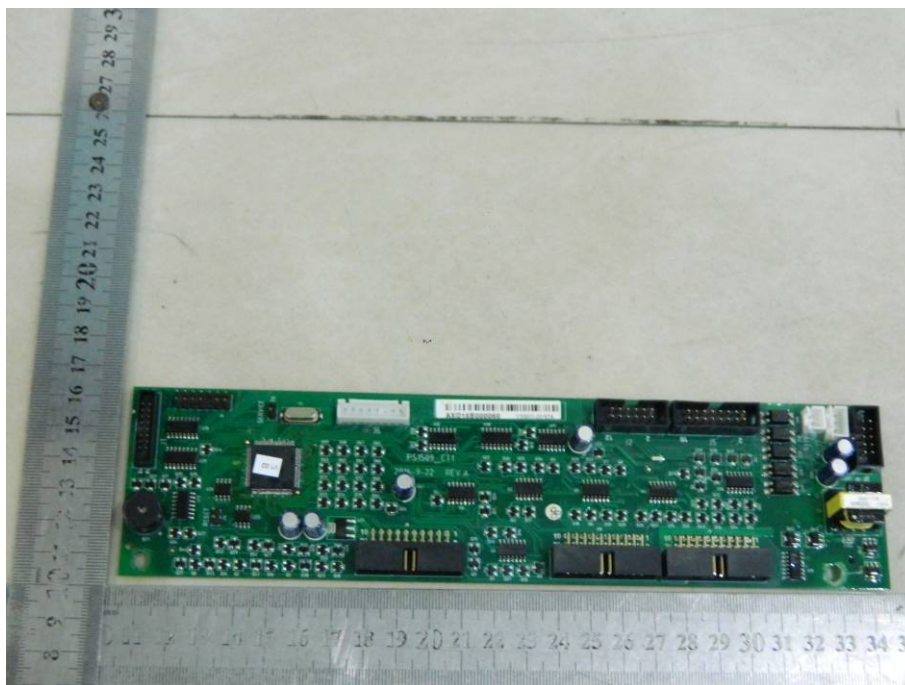
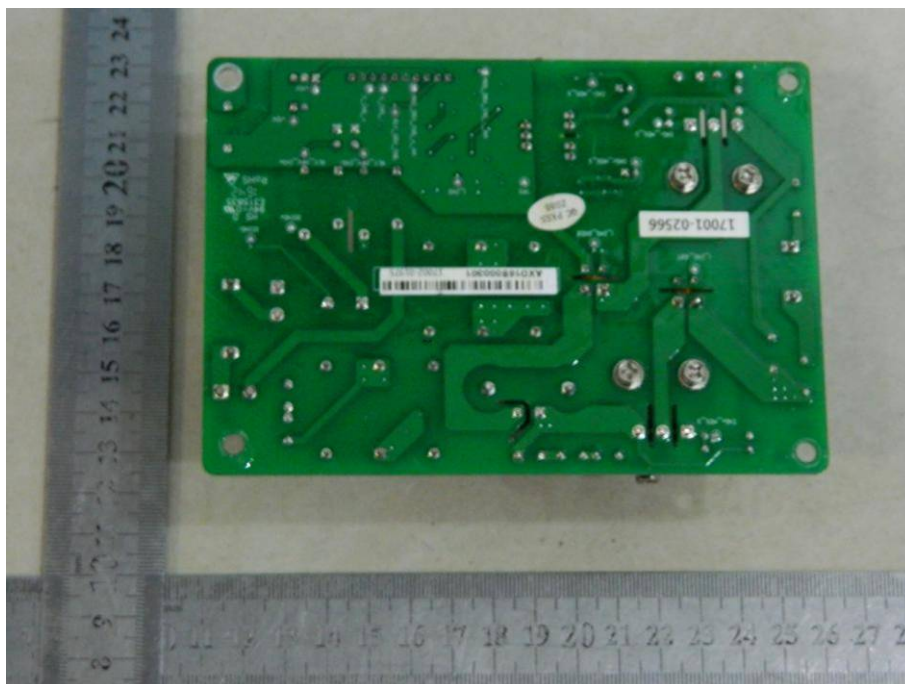

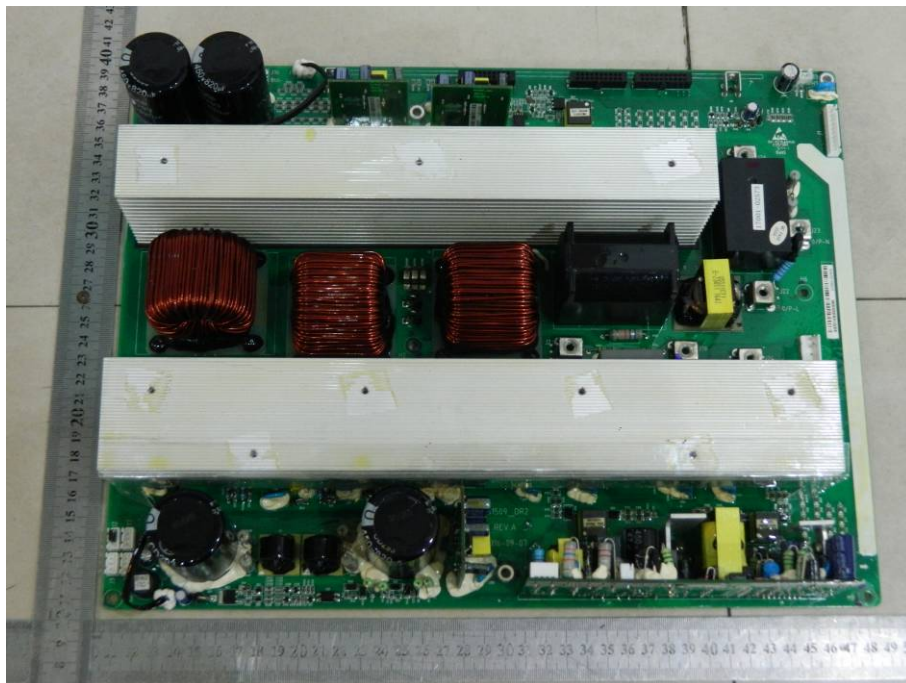
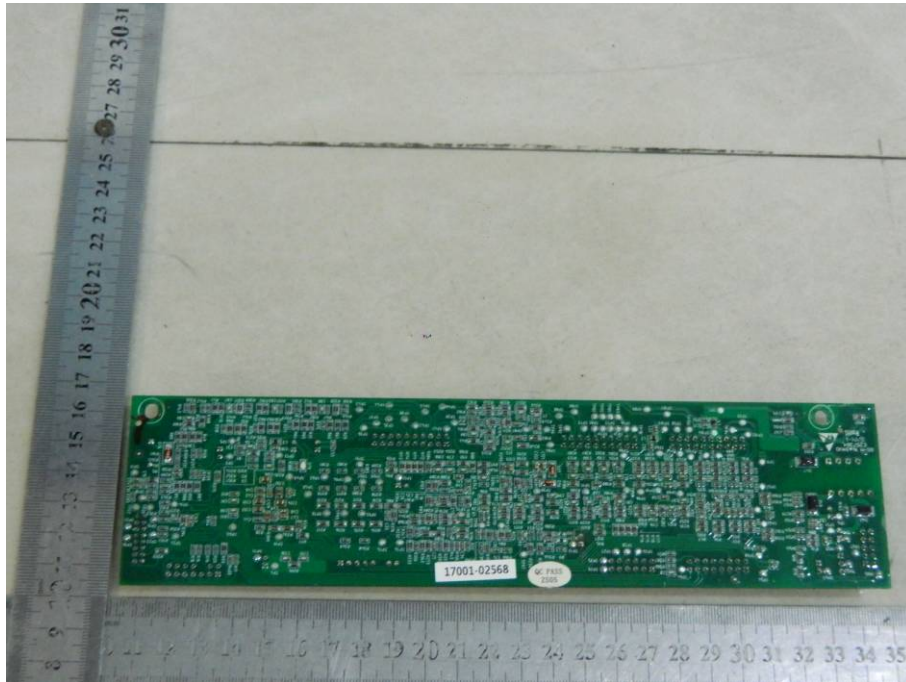

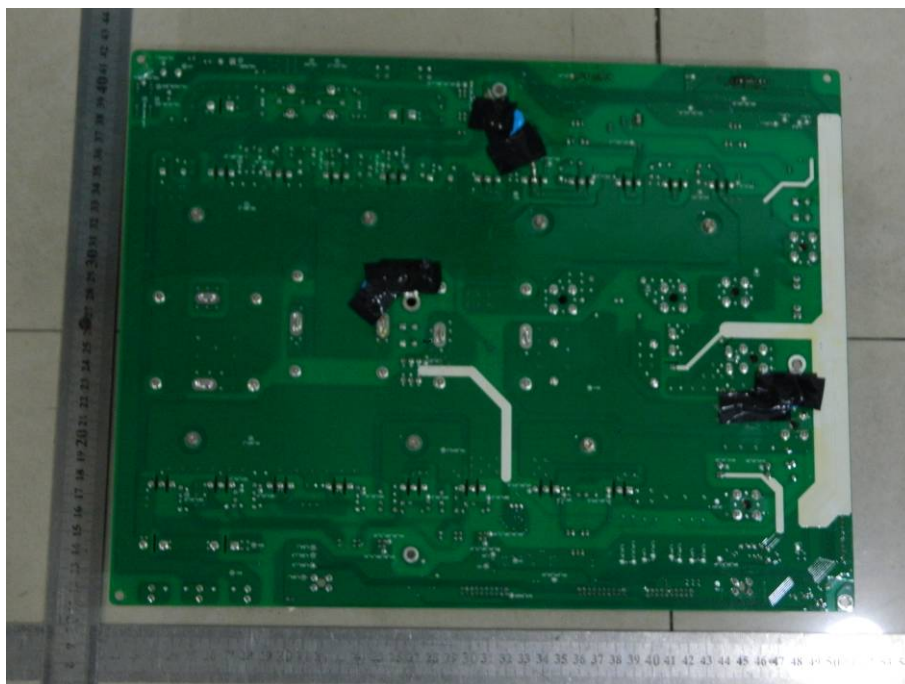

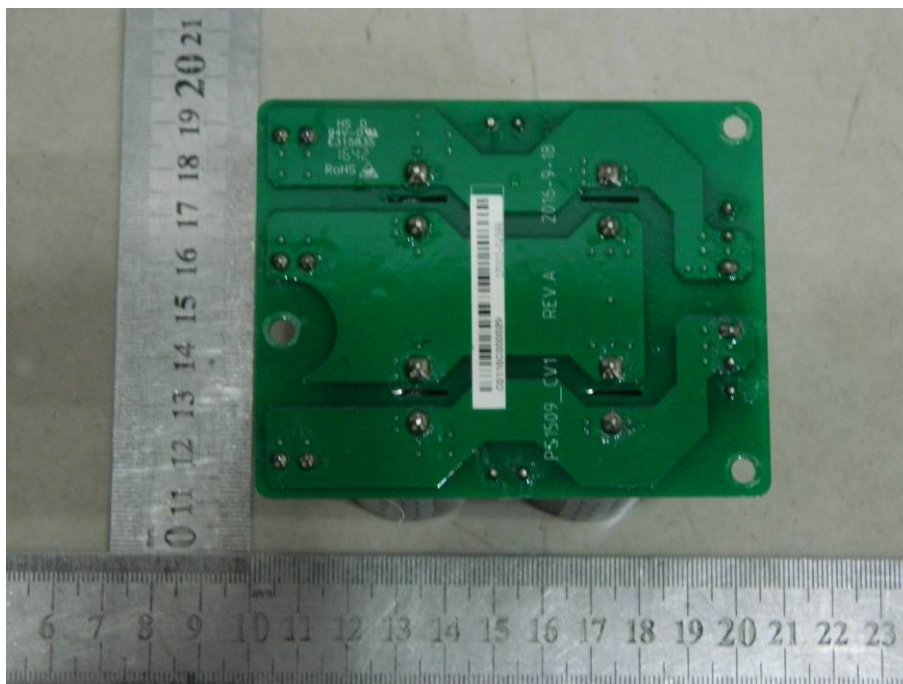

External battery



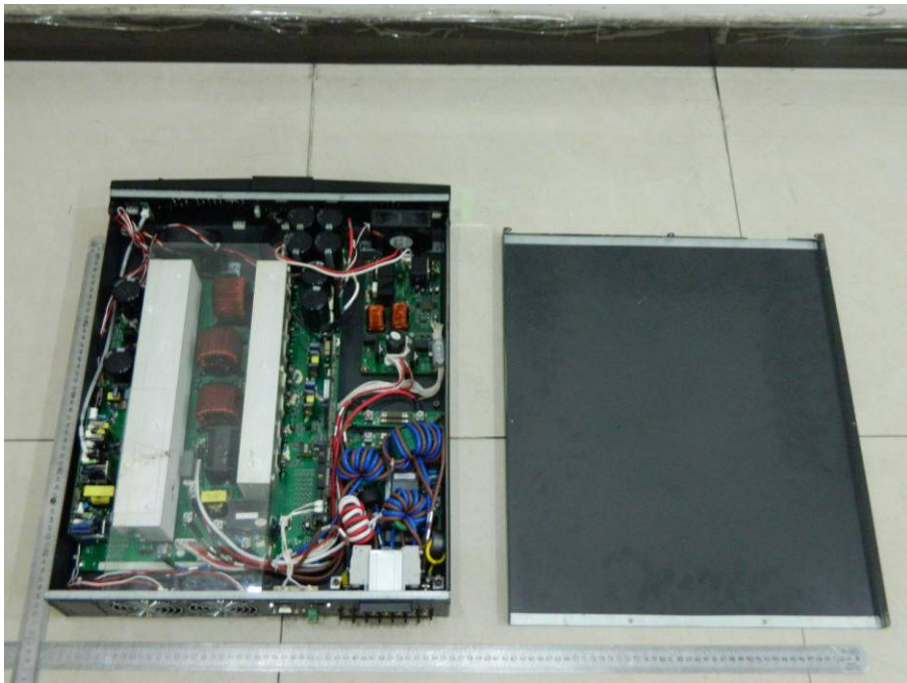

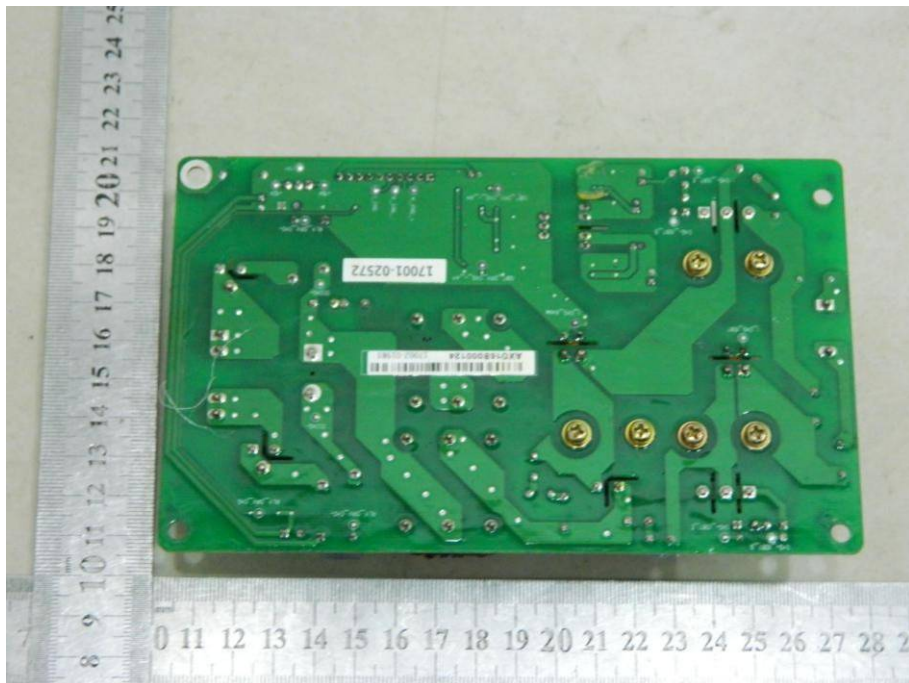
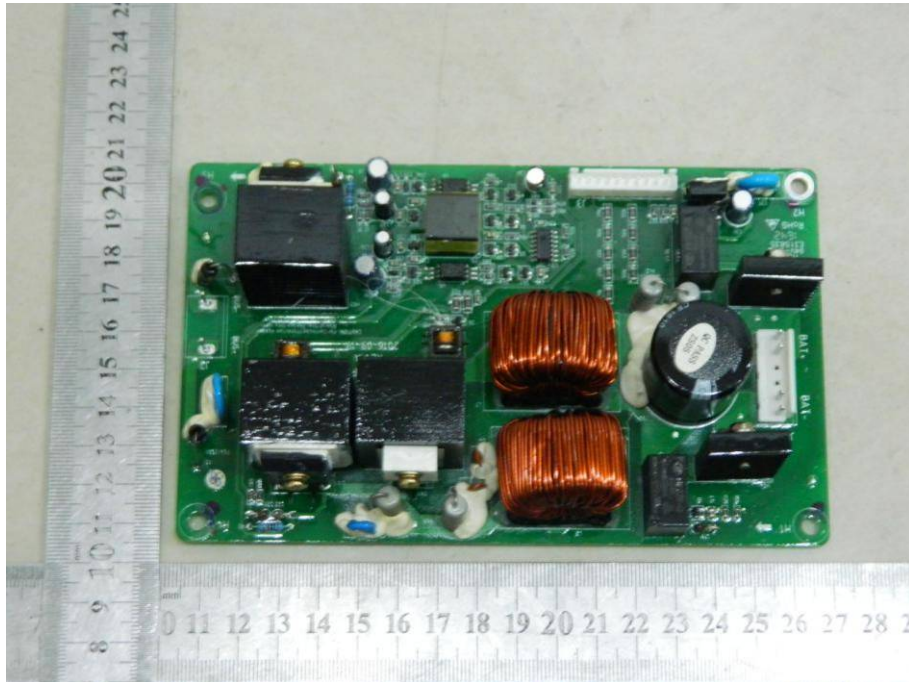

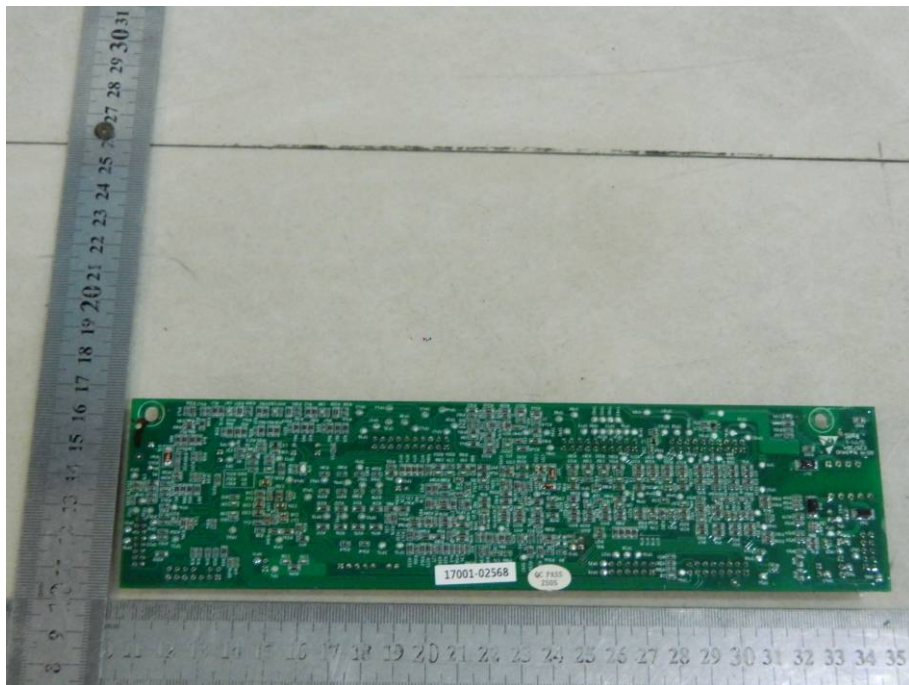
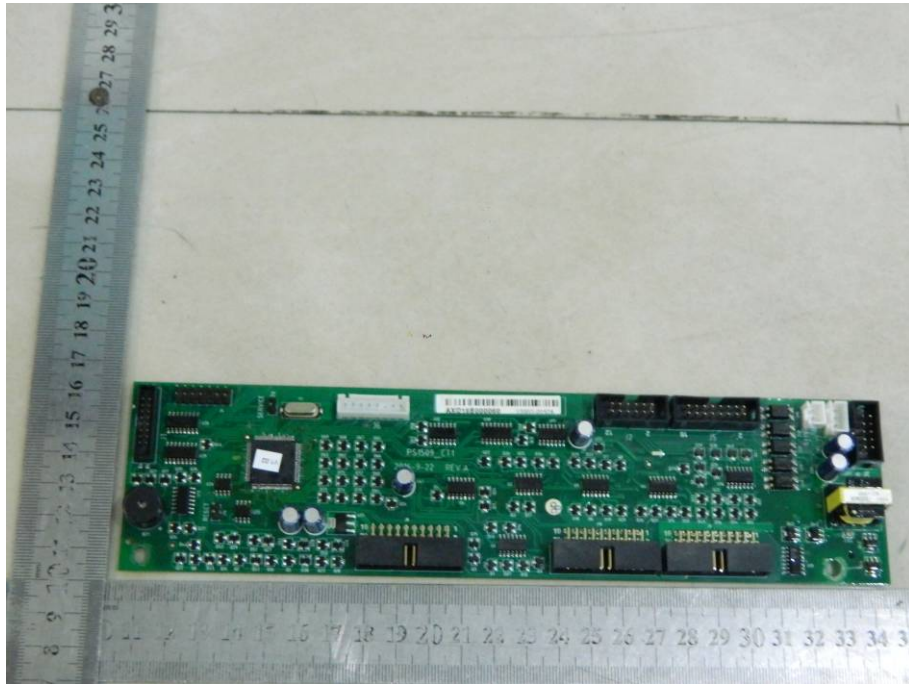

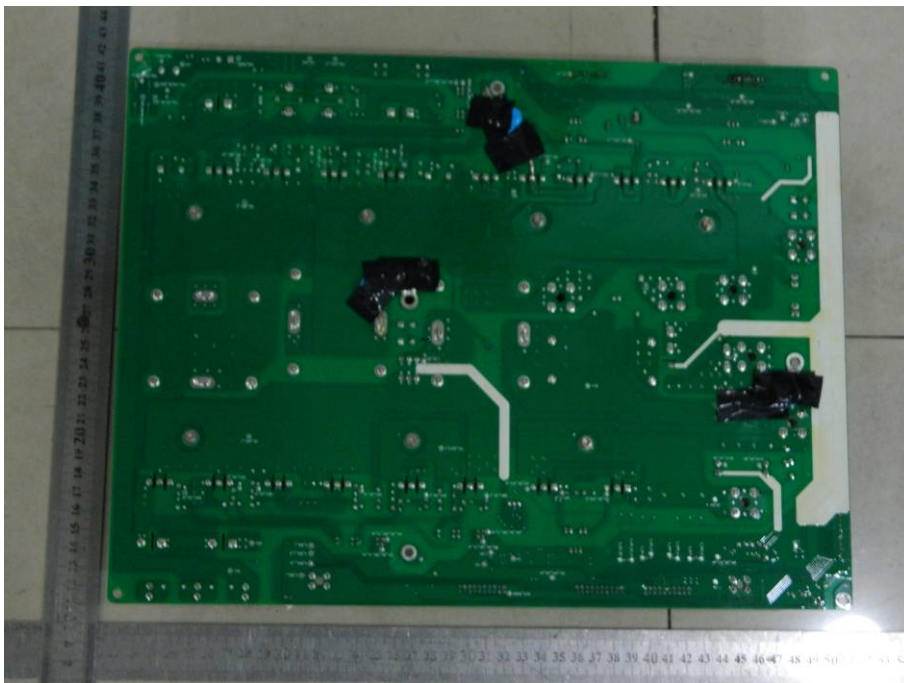
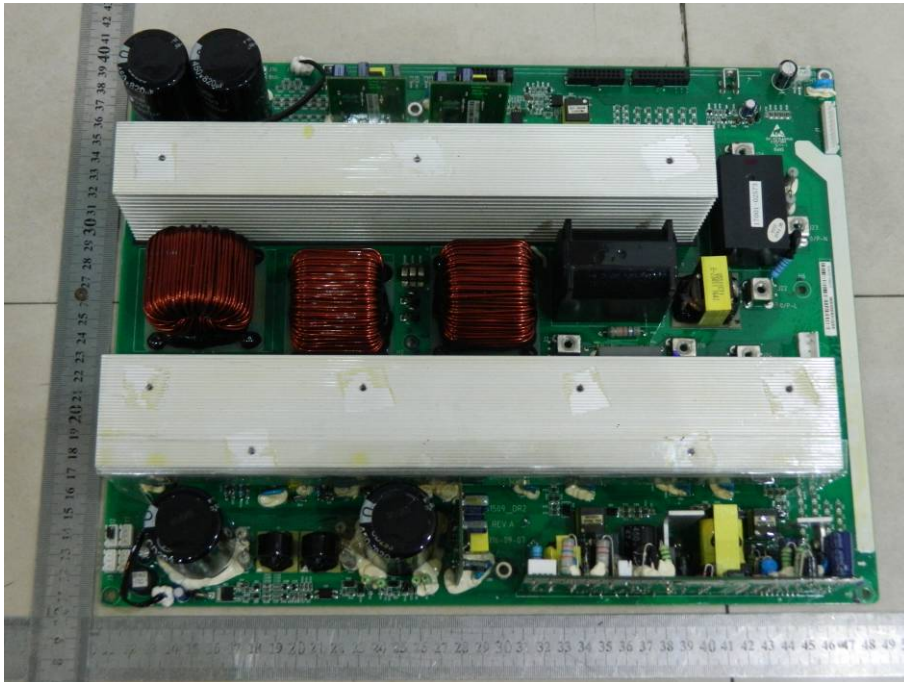

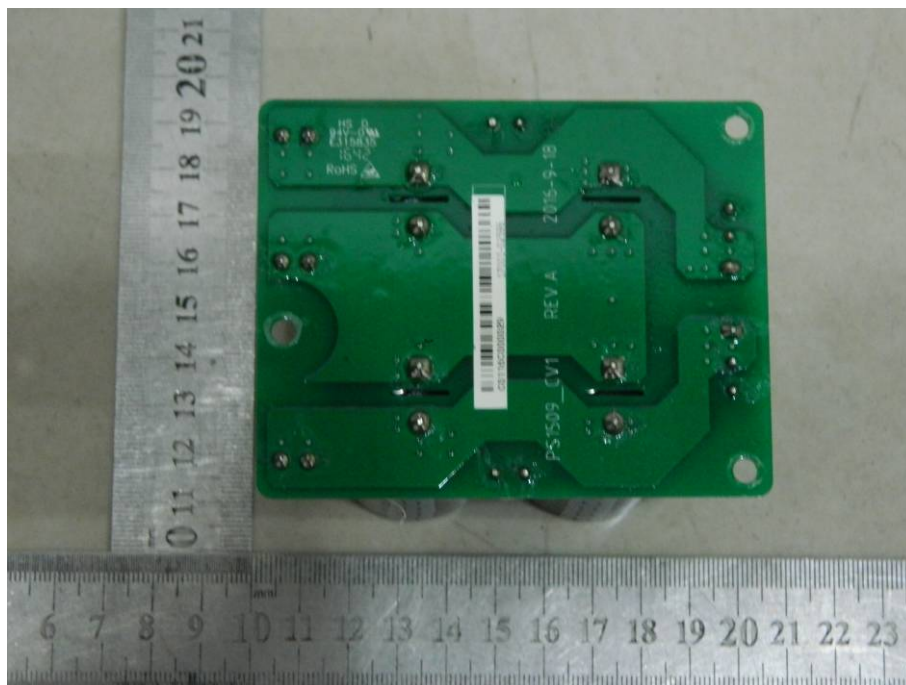
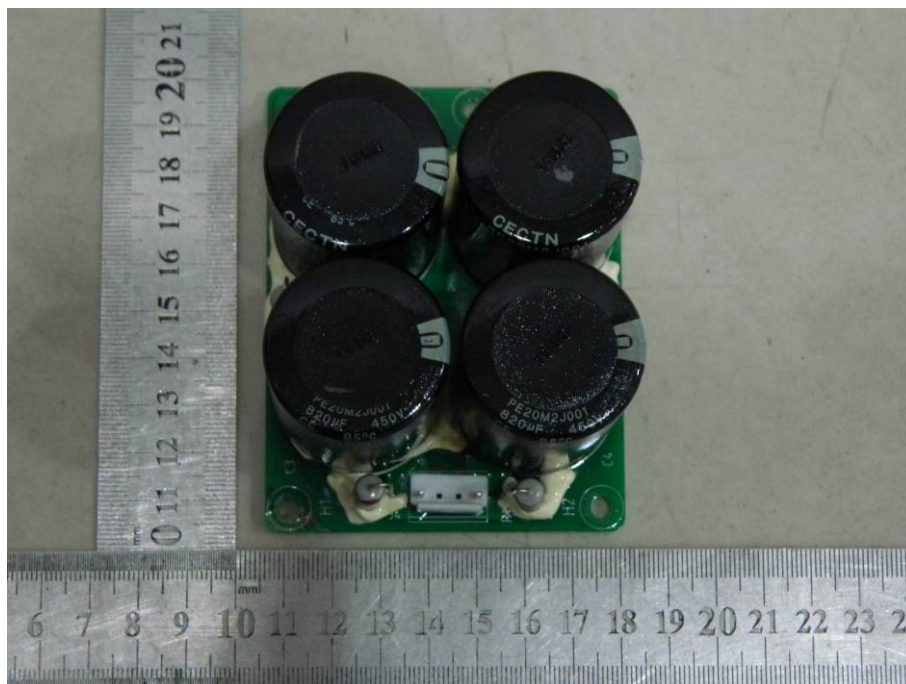

-----The end -----