

EMC TEST REPORT
For

INVT POWER SYSTEM (SHENZHEN) CO., LTD

Uninterruptible Power Systems

Model No.: HR1110S, HR1108S, HR1106S, HR1105S, HT1104S, HR1104S,
HR1110L, HR1108L, HR1106L, HR1105L, HT1104L, HR1104L

Prepared for : INVT POWER SYSTEM (SHENZHEN) CO., LTD
Address : 5# Building, Gaofa Industrial Park, Longjing, Nanshan District
Shenzhen, China, 518055

Prepared by : EMTEK(SHENZHEN) CO., LTD.
Address : Bldg 69, Majialong Industry Zone,
Nanshan District, Shenzhen, Guangdong, China

Tel: (0755) 26954280
Fax: (0755) 26954282

Report Number : ES160629004E
Date of Test : February 28, 2012 to March 10, 2012
Date of Report : June 29, 2016

TABLE OF CONTENT

Test Report Description	Page
1. SUMMARY OF TEST RESULT.....	7
2. GENERAL INFORMATION.....	8
2.1. Description of Device (EUT).....	8
2.2. Description of Test Facility.....	9
2.3. Measurement Uncertainty.....	9
3. MEASURING DEVICE AND TEST EQUIPMENT.....	10
3.1. For Power Line Conducted Emission Measurement.....	10
3.2. For 10m Radiated Emission Measurement.....	10
3.3. For Electrostatic Discharge Immunity Test.....	10
3.4. For RF Strength Susceptibility Test.....	11
3.5. For Electrical Fast Transient /Burst Immunity Test.....	11
3.6. For Surge Immunity Test.....	11
3.7. For Injected Current Susceptibility Test.....	11
3.8. For Magnetic Field Immunity Test.....	12
3.9. For Voltage Dips and Interruptions Test.....	12
3.10. For Low Frequency Signals Test.....	12
4. POWER LINE CONDUCTED EMISSION MEASUREMENT.....	13
4.1. Block Diagram of Test Setup.....	13
4.2. Measuring Standard.....	13
4.3. Power Line Conducted Emission Limits (C3).....	13
4.4. EUT Configuration on Measurement.....	13
4.5. Operating Condition of EUT.....	13
4.6. Test Procedure.....	14
4.7. Measuring Results.....	14
5. RADIATED EMISSION MEASUREMENT.....	15
5.1. Block Diagram of Test Setup.....	15
5.2. Measuring Standard.....	15
5.3. Radiated Emission Limits (C3).....	15
5.4. EUT Configuration on Measurement.....	16
5.5. Operating Condition of EUT.....	16
5.6. Test Procedure.....	16
5.7. Measuring Results.....	16
6. ELECTROSTATIC DISCHARGE IMMUNITY TEST.....	17
6.1. Block Diagram of Test Setup.....	17
6.2. Test Standard.....	17
6.3. Severity Levels and Performance Criterion.....	17
6.4. Operating Condition of EUT.....	18
6.5. Test Procedure.....	18
6.6. Test Results.....	18
7. RF FIELD STRENGTH SUSCEPTIBILITY TEST.....	20

7.1. Block Diagram of Test Setup.....	20
7.2. Test Standard.....	20
7.3. Severity Levels and Performance Criterion.....	21
7.4. Operating Condition of EUT.....	21
7.5. Test Procedure.....	21
7.6. Test Results.....	21
8. ELECTRICAL FAST TRANSIENT/BURST IMMUNITY TEST.....	23
8.1. Block Diagram of Test Setup.....	23
8.2. Test Standard.....	23
8.3. Severity Levels and Performance Criterion.....	23
8.4. Operating Condition of EUT.....	24
8.5. Test Procedure.....	24
8.6. Test Results.....	24
9. SURGE IMMUNITY TEST.....	26
9.1. Block Diagram of Test Setup.....	26
9.2. Test Standard.....	26
9.3. Severity Levels and Performance Criterion.....	26
9.4. Operating Condition of EUT.....	26
9.5. Test Procedure.....	27
9.6. Test Results.....	27
10. INJECTED CURRENTS SUSCEPTIBILITY TEST.....	29
10.1. Block Diagram of Test Setup.....	29
10.2. Test Standard.....	29
10.3. Severity Levels and Performance Criterion.....	29
10.4. Operating Condition of EUT.....	30
10.5. Test Procedure.....	30
10.6. Test Results.....	30
11. MAGNETIC FIELD SUSCEPTIBILITY TEST.....	32
11.1. Block Diagram of Test Setup.....	32
11.2. Test Standard.....	32
11.3. Severity Levels and Performance Criterion.....	32
11.4. Operating Condition of EUT.....	33
11.5. Test Procedure.....	33
11.6. Test Results.....	33
12. VOLTAGE DIPS AND INTERRUPTIONS TEST.....	35
12.1. Block Diagram of Test Setup.....	35
12.2. Test Standard.....	35
12.3. Severity Levels and Performance Criterion.....	35
12.4. Operating Condition of EUT.....	36
12.5. Test Procedure.....	36
12.6. Test Results.....	36
13. LOW FREQUENCY SIGNALS TEST.....	38
13.1. Block Diagram of Test Setup.....	38
13.2. Test Standard.....	38
13.3. Operating Condition of EUT.....	38
13.4. Test Results.....	38

14. PHOTOGRAPHS.....	40
14.1. Photo of Conducted Emission Measurement.....	40
14.2. Photo of Radiation Emission Measurement.....	40
14.3. Photo of RF Strength Susceptibility Test.....	41
14.4. Photo of Electrical Fast Transient / Burst Test.....	41
14.5. Photo of Surge Test.....	42
14.6. Photo of Injected Currents Susceptibility Test.....	42
14.7. Photo of Magnetic Field Immunity Test.....	43
14.8. Photo of Voltage Dips and Interruption Immunity Test.....	43

APPENDIX I (8 Pages)

APPENDIX II (8 Pages)

APPENDIX III (Photos of EUT) (6 Pages)

TEST REPORT DESCRIPTION

Applicant : INVT POWER SYSTEM (SHENZHEN) CO., LTD
Manufacturer : INVT POWER SYSTEM (SHENZHEN) CO., LTD
Trade Mark : INVT
EUT : Uninterruptible Power Systems
Model No. : HR1110S, HR1108S, HR1106S, HR1105S, HT1104S, HR1104S,
HR1110L, HR1108L, HR1106L, HR1105L, HT1104L, HR1104L

Measurement Procedure Used:

EN 62040-2:2006
(EN 61000-4-2:2009, EN 61000-4-3:2006+A1:2008+A2:2010, EN 61000-4-4:2012, EN
61000-4-5:2014, EN 61000-4-6:2014, EN 61000-4-8:2010, EN 61000-4-11:2004,
EN 61000-2-2:2002)

The device described above is tested by EMTEK(SHENZHEN) CO., LTD. to determine the maximum emission levels emanating from the device and the severe levels of the device can endure and its performance criterion. The measurement results are contained in this test report and EMTEK(SHENZHEN) CO., LTD. is assumed full of responsibility for the accuracy and completeness of these measurements. Also, this report shows that the EUT (Equipment Under Test) is technically compliant with the EN 62040-2 requirements.

This report applies to above tested sample only and shall not be reproduced in part without written approval of EMTEK(SHENZHEN) CO., LTD.

Date of Test : February 28, 2012 to March 10, 2012

Prepared by : 
Bunny Zhang/Editor

Reviewer : 
Jessie Hu/Supervisor

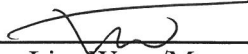
Approved & Authorized Signer : 
Lisa Wang/Manager

Modified History

Version	Report No.	Revision Date	Summary
Ver.1.0	ES111222137E	/	Original Report
Ver.1.2	ES111222137E-2	August 24, 2013	1. Change Model name 2. Standard updated
Ver.1.0	ES160629004E	June 29, 2016	Update EMC directive and standards

Note: Standard updated not impact on EMC compliance of the product.

1. SUMMARY OF TEST RESULT

EMISSION			
Description of Test Item	Standard	Limits	Results
Conducted Disturbance at Mains Terminals	EN 62040-2:2006	C3	Pass
Radiated Disturbance	EN 62040-2:2006	C3	Pass
IMMUNITY (C3)			
Description of Test Item	Basic Standard	Performance Criteria	Results
Electrostatic Discharge (ESD)	EN 61000-4-2:2009	B	Pass
Radio-Frequency, Continuous Radiated Disturbance	EN 61000-4-3:2006 +A1:2008+A2:2010	A	Pass
EFT/B Immunity	EN 61000-4-4:2012	B	Pass
Surge Immunity	EN 61000-4-5:2014	B	Pass
Conducted RF Immunity	EN 61000-4-6:2014	A	Pass
Power Frequency Magnetic Field	EN 61000-4-8:2010	A	Pass
Voltage Dips	EN 61000-4-11:2004	A	Pass
Low Frequency Signals	EN 61000-2-2:2002	A	Pass
Note: N/A is an abbreviation for Not Applicable.			

2. GENERAL INFORMATION

2.1. Description of Device (EUT)

EUT	:	Uninterruptible Power Systems
Model Number	:	HR1110S, HR1108S, HR1106S, HR1105S, HT1104S, HR1104S, HR1110L, HR1108L, HR1106L, HR1105L, HT1104L, HR1104L (Note: All the modes have the same PCB and circuit diagram, only differences are the output current, input current and rating power. We take HR1110S & HR1106L to test EMI items, take HR1110S to test EMS items.)
Ratings	:	<p>HR1110S AC Input: 220-240VAC, 1ϕ+N+PE, 50/60Hz, 47A max Output: 220-240VAC, 1ϕ+N+PE, 50/60Hz, 10KVA/9KW</p> <p>HR1108S AC Input: 220-240VAC, 1ϕ+N+PE, 50/60Hz, 38A max Output: 220-240VAC, 1ϕ+N+PE, 50/60Hz, 8KVA/7.2KW</p> <p>HR1106S AC Input: 220-240VAC, 1ϕ+N+PE, 50/60Hz, 28A max Output: 220-240VAC, 1ϕ+N+PE, 50/60Hz, 6KVA/5.4KW</p> <p>HR1105S AC Input: 220-240VAC, 1ϕ+N+PE, 50/60Hz, 24A max Output: 220-240VAC, 1ϕ+N+PE, 50/60Hz, 5KVA/4.5KW</p> <p>HR1110L AC Input: 220-240VAC, 1ϕ+N+PE, 50/60Hz, 49A max Batt. Input: 192VDC, 52A max Output: 220-240VAC, 1ϕ+N+PE, 50/60Hz, 10KVA/9KW</p> <p>HR1108L AC Input: 220-240VAC, 1ϕ+N+PE, 50/60Hz, 39A max Batt. Input: 192VDC, 42A max Output: 220-240VAC, 1ϕ+N+PE, 50/60Hz, 8KVA/7.2KW</p> <p>HR1106L AC Input: 220-240VAC, 1ϕ+N+PE, 50/60Hz, 29A max Batt. Input: 192VDC, 31A max Output: 220-240VAC, 1ϕ+N+PE, 50/60Hz, 6KVA/5.4KW</p> <p>HR1105L AC Input: 220-240VAC, 1ϕ+N+PE, 50/60Hz, 24A max Batt. Input: 192VDC, 26A max Output: 220-240VAC, 1ϕ+N+PE, 50/60Hz, 5KVA/4.5KW</p>

Test Voltage : AC 230V / 50Hz

Applicant : INVT POWER SYSTEM (SHENZHEN) CO., LTD

Address : 5# Building, Gaofa Industrial Park, Longjing, Nanshan District
Shenzhen, China, 518055

Manufacturer : INVT POWER SYSTEM (SHENZHEN) CO., LTD

Address : 5# Building, Gaofa Industrial Park, Longjing, Nanshan District
Shenzhen, China, 518055

Date of Received : February 27, 2012

Date of Test : February 28, 2012 to March 10, 2012

2.2. Description of Test Facility

Site Description

EMC Lab. : Accredited by CNAS, 2013.10.29
The certificate is valid until 2016.10.28
The Laboratory has been assessed and proved to be in compliance
with CNAS-CL01:2006 (identical to ISO/IEC 17025:2005)
The Certificate Registration Number is L2291.

Accredited by TUV Rheinland Shenzhen 2010.5.25
The Laboratory has been assessed according to the requirements
ISO/IEC 17025.

Accredited by FCC, April 17, 2013
The Certificate Registration Number is 709623.

Accredited by Industry Canada, November 24, 2015
The Certificate Registration Number is 4480A.

Name of Firm : EMTEK(SHENZHEN) CO., LTD.

Site Location : Bldg 69, Majialong Industry Zone,
Nanshan District, Shenzhen, Guangdong, China

2.3. Measurement Uncertainty

Conducted Emission Uncertainty : 2.8dB

Radiated Emission Uncertainty : 4.2dB (10m Chamber)

3. MEASURING DEVICE AND TEST EQUIPMENT

3.1. For Power Line Conducted Emission Measurement

Item	Equipment	Manufacturer	Model No.	Serial No.	Last Cal.	Cal. Interval
1.	Test Receiver	Rohde & Schwarz	ESCS30	828985/018	May 29, 2011	1 Year
2.	L.I.S.N.	Schwarzbeck	NNLK8129	8129-203	May 29, 2011	1 Year
4.	L.I.S.N.	Rohde & Schwarz	ESH3-Z6	100011	May 29, 2011	1 Year
5.	L.I.S.N.	Rohde & Schwarz	ESH3-Z6	100253	May 29, 2011	1 Year
6.	L.I.S.N.	Rohde & Schwarz	ESH3-Z5	100191	May 29, 2011	1 Year
7.	50Ω Coaxial Switch	Anritsu	MP59B	M20531	N/A	N/A
8.	Pulse Limiter	Rohde & Schwarz	ESH3-Z2	100006	May 29, 2011	1 Year
9.	Voltage Probe	Rohde & Schwarz	TK9416	N/A	May 29, 2011	1 Year
10.	I.S.N	Rohde & Schwarz	ENY22	1109.9508.02	May 29, 2011	1 Year

3.2. For 10m Radiated Emission Measurement

Item	Equipment	Manufacturer	Model No.	Serial No.	Last Cal.	Cal. Interval
1.	EMI Test Receiver	Rohde & Schwarz	ESCI	101045	May 29, 2011	1 Year
2.	Pre-Amplifier	CD	PAP-0203	22013	May 29, 2011	1 Year
3.	Bilog Antenna	Schwarzbeck	VULB9163	141	May 29, 2011	1 Year
4.	Cable	H+B	CBL3-NN-0.5m	100319-2140500-1	May 29, 2011	1 Year
5.	Cable	H+B	CBL3-NN-3m	100319-2143000-1	May 29, 2011	1 Year
6.	Cable	H+B	CBL3-NN-6.5m	100319-2146500-1	May 29, 2011	1 Year
7.	Cable	H+B	CBL3-NN-10.5m	100319-21410500	May 29, 2011	1 Year
8.	Cable	H+B	CBL3-NN-12.5m	100319-21412500	May 29, 2011	1 Year

3.3. For Electrostatic Discharge Immunity Test

Item	Equipment	Manufacturer	Model No.	Serial No.	Last Cal.	Cal. Interval
1.	ESD Tester	TESEQAG	NSG 437	000409	May 29, 2011	1 Year

3.4.For RF Strength Susceptibility Test

Item	Equipment	Manufacturer	Model No.	Serial No.	Last Cal.	Cal. Interval
1.	RF Power Meter. Dual Channel	BOONTON	4232A	10539	May 29, 2011	1 Year
2.	50ohm Diode Power Sensor	BOONTON	51011EMC	34236/34238	May 29, 2011	1 Year
3.	Broad-Band Horn Antenna	SCHWARZB ECK	BBHA 9120 L3F	332	May 29, 2011	1 Year
4.	Power Amplifier	PRANA	AP32MT215	N/A	May 29, 2011	1 Year
5.	Power Amplifier	MILMEGA	AS0102-55	N/A	May 29, 2011	1 Year
6.	Signal Generator	AEROFLEX	2023B	N/A	May 29, 2011	1 Year
7.	Field Strength Meter	HOLADAY	HI-6005	N/A	May 29, 2011	1 Year
8.	RS232 Fiber Optic Modem	HOLADAY	HI-4413P	N/A	May 29, 2011	1 Year
9.	Log.-Per. Antenna	SCHWARZB ECK	VULP 9118E	N/A	May 29, 2011	1 Year

3.5.For Electrical Fast Transient /Burst Immunity Test

Item	Equipment	Manufacturer	Model No.	Serial No.	Last Cal.	Cal. Interval
1.	Burst Tester	HAEFELY	PEFT4010	080981-16	May 29, 2011	1 Year
2.	Coupling Clamp	HAEFELY	IP-4A	147147	May 29, 2011	1 Year

3.6.For Surge Immunity Test

Item	Equipment	Manufacturer	Model No.	Serial No.	Last Cal.	Cal. Interval
1.	Surge Controller	HAEFELY	Psurge 8000	174031	May 29, 2011	1 Year
2.	Impulse Module	HAEFELY	PIM 100	174124	May 29, 2011	1 Year
3.	Coupling Decoupling Filter	HAEFELY	PCD 130	172181	May 29, 2011	1 Year
4.	Coupling Module	HAEFELY	PCD122	174354	May 29, 2011	1 Year
5.	Surge Impulse Module	HAEFELY	PIM 120	174435	May 29, 2011	1 Year
6.	Coupling Module	HAEFELY	PCD 126A	174387	May 29, 2011	1 Year
7.	Impulse Module	HAEFELY	PIM 110	174391	May 29, 2011	1 Year

3.7.For Injected Current Susceptibility Test

Item	Equipment	Manufacturer	Model No.	Serial No.	Last Cal.	Cal. Interval
1.	Simulator	EMTEST	CWS500C	0900-12	May 29, 2011	1 Year
2.	CDN	EMTEST	CDN-M2	5100100100	May 29, 2011	1 Year
3.	CDN	EMTEST	CDN-M3	0900-11	May 29, 2011	1 Year
4.	Injection Clamp	EMTEST	F-2031-23MM	368	May 29, 2011	1 Year
5.	Attenuator	EMTEST	ATT6	0010222A	May 29, 2011	1 Year

3.8.For Magnetic Field Immunity Test

Item	Equipment	Manufacturer	Model No.	Serial No.	Last Cal.	Cal. Interval
1.	Magnetic Field Tester	HAEFELY	MAG100	250040.1	May 29, 2011	1 Year

3.9.For Voltage Dips and Interruptions Test

Item	Equipment	Manufacturer	Model No.	Serial No.	Last Cal.	Cal. Interval
1.	Dips Tester	HAEFELY	Pline1610	083732-12	May 29, 2011	1 Year

3.10.For Low Frequency Signals Test

Item	Equipment	Manufacturer	Model No.	Serial No.	Last Cal.	Cal. Interval
1.	Programmable AC Source	CHROMA	6530	/	May 29, 2011	1 Year

4. POWER LINE CONDUCTED EMISSION MEASUREMENT

4.1. Block Diagram of Test Setup

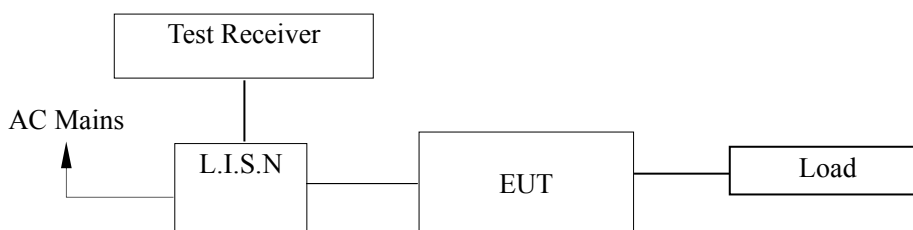

(EUT: Uninterruptible Power Systems)

4.2. Measuring Standard

EN 62040-2:2006 Category C3

4.3. Power Line Conducted Emission Limits (C3)

UPS rated output current A	Frequency range MHz	Limits dB (μV)	
		Quasi-peak	Average
>16 – 100	0,15 to 0,50 ^b	100	90
	0,50 to 5,0 ^b	86	76
	5,0 to 30,0	90 to 70 ^a	80 to 60 ^a
>100	0,15 to 0,50 ^b	130	120
	0,50 to 5,0 ^b	125	115
	5,0 to 30,0	115	105

^a The limits decrease linearly with the logarithm of the frequency.
^b The lower limit shall apply at the transition frequency.

4.4. EUT Configuration on Measurement

The following equipments are installed on Conducted Emission Measurement to meet EN 62040-2 requirements and operating in a manner which tends to maximize its emission characteristics in a normal application.

EUT : Uninterruptible Power Systems
 Model Number : HR1110S, HR1106L

4.5. Operating Condition of EUT

4.5.1. Setup the EUT as shown on Section 4.1.

4.5.2. Turn on the power of all equipments.

4.5.3. Let the EUT work in measuring mode (Line mode, Battery mode) and measure it.

4.6. Test Procedure

The EUT is put on the plane 0.1m high above the ground by insulating support and connected to the AC mains through Line Impedance Stability Network (L.I.S.N). This provided a 50ohm coupling impedance for the tested equipments. Both sides of AC line are investigated to find out the maximum conducted emission according to the EN62040-2 regulations during conducted emission measurement.

The bandwidth of the field strength meter (R&S Test Receiver ESCS30) is set at 9kHz in 150kHz~30MHz and 200Hz in 9kHz~150kHz.

The frequency range from 150kHz to 30MHz is investigated.

4.7. Measuring Results

PASS.

All the scanning waveform is put in Appendix I.

5. RADIATED EMISSION MEASUREMENT

5.1. Block Diagram of Test Setup

5.1.1. Block diagram of EUT System



(EUT: Uninterruptible Power Systems)

5.1.2. Block diagram of test setup (In chamber)

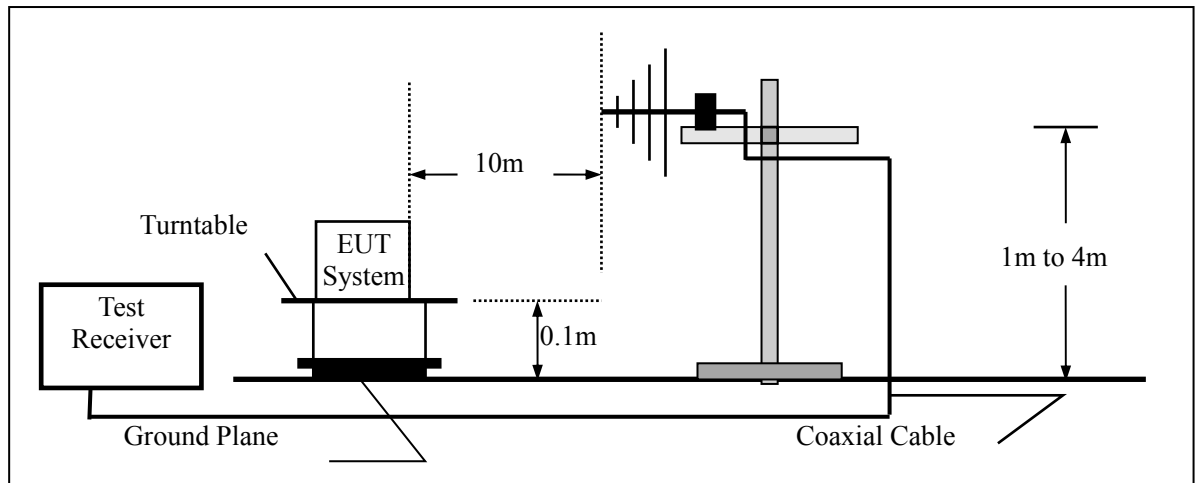

(EUT: Uninterruptible Power Systems)

5.2. Measuring Standard

EN 62040-2:2006 Category C3

5.3. Radiated Emission Limits (C3)

All emanations from a C3 device or system, including any network of conductors and apparatus connected thereto, shall not exceed the level of field strengths specified below:

FREQUENCY (MHz)	DISTANCE (Meters)	FIELD STRENGTHS LIMIT (dB μ V/m)
30 ~ 230	10	50
230 ~ 1000	10	60

- Note:
- (1) The smaller limit shall apply at the combination point between two frequency bands.
 - (2) Distance refers to the distance in meters between the measuring

instrument antenna and the closed point of any part of the EUT.

5.4.EUT Configuration on Measurement

The EN 62040-2 regulations test method must be used to find the maximum emission during radiated emission measurement.

EUT : Uninterruptible Power Systems
Model Number : HR1110S, HR1106L

5.5.Operating Condition of EUT

5.5.1.Setup the EUT as shown on Section 5.1.

5.5.2.Turn on the power of all equipments.

5.5.3.Let the EUT work in measuring mode (Line mode, Battery mode) and measure it.

5.6.Test Procedure

The EUT is placed on a turn table which is 0.1 meter high above the ground. The turn table can rotate 360 degrees to determine the position of the maximum emission level. The EUT is set 10 meters away from the receiving antenna which is mounted on a antenna tower. The antenna can be moved up and down from 1 to 4 meters to find out the maximum emission level. Bilog antenna (calibrated by Dipole Antenna) is used as a receiving antenna. Both horizontal and vertical polarization of the antenna are set on test.

The bandwidth of the Receiver is set at 120kHz.
All the scanning curves are attached in Appendix II.

5.7.Measuring Results

PASS.

The frequency range from 30MHz to 1000MHz is investigated.

Please reference to Appendix II.

6. ELECTROSTATIC DISCHARGE IMMUNITY TEST

6.1. Block Diagram of Test Setup

6.1.1. Block diagram of EUT System



(EUT: Uninterruptible Power Systems)

6.1.2. Block diagram of ESD test setup

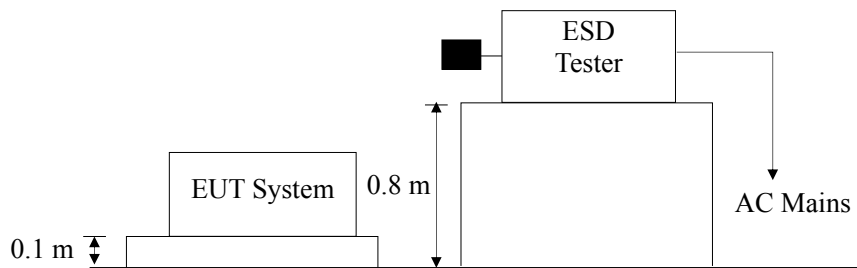

(EUT: Uninterruptible Power Systems)

6.2. Test Standard

EN 62040-2:2006

(EN 61000-4-2:2009 Severity Level: 3 / Air Discharge: $\pm 8\text{kV}$)

Level: 2 / Contact Discharge: $\pm 4\text{kV}$)

6.3. Severity Levels and Performance Criterion

6.3.1. Severity level

Level	Test Voltage Contact Discharge (kV)	Test Voltage Air Discharge (kV)
1.	± 2	± 2
2.	± 4	± 4
3.	± 6	± 8
4.	± 8	± 15
X	Special	Special

6.3.2. Performance criterion: B

6.4. Operating Condition of EUT

6.4.1. Setup the EUT as shown on Section 6.1.

6.4.2. Turn on the power of all equipments.

6.4.3. Let the EUT work in test mode (Line mode, Battery mode) and test it.

6.5. Test Procedure

6.5.1. Air Discharge:

This test is done on a non-conductive surface. The round discharge tip of the discharge electrode shall be approached as fast as possible to touch the EUT. After each discharge, the discharge electrode shall be removed from the EUT. The generator is then re-triggered for a new single discharge and repeated 10 times for each pre-selected test point. This procedure shall be repeated until all the air discharge completed.

6.5.2. Contact Discharge:

All the procedure shall be same as Section 6.5.1. Except that the tip of the discharge electrode shall touch the EUT before the discharge switch is operated.

6.5.3. Indirect discharge for horizontal coupling plane

At least 10 single discharges (in the most sensitive polarity) shall be applied at the front edge of each HCP opposite the center point of each unit (if applicable) of the EUT and 0.1m from the front of the EUT. The long axis of the discharge electrode shall be in the plane of the HCP and perpendicular to its front edge during the discharge.

6.5.4. Indirect discharge for vertical coupling plane

At least 10 singles discharge (in the most sensitive polarity) shall be applied to the center of one vertical edge of the coupling plane. The coupling plane, of dimensions 0.5m×0.5m, is placed parallel to, and positioned at a distance of 0.1m from the EUT. Discharges shall be applied to the coupling plane, with this plane in sufficient different positions that the four faces of the EUT are completely illuminated.

6.6. Test Results

PASS.

Please refer to the following pages

Electrostatic Discharge Test Results

EMTEK(SHENZHEN) CO., LTD.

Applicant	: INVT POWER SYSTEM (SHENZHEN) CO., LTD		
EUT	: Uninterruptible Power Systems	Test Date	: March 06, 2012
M/N	: HR1110S	Temperature	: 22°C
Power Supply	: AC 230V / 50Hz	Humidity	: 51%
Air discharge	: ± 8.0kV	Test Mode	: Line mode/ Battery mode
Contact discharge:	± 4.0kV	Criterion	: B
Location	Kind A-Air Discharge C-Contact Discharge	Result	
All slots of EUT	A	PASS	
Metal	C	PASS	
Button	A	PASS	
Screw	C	PASS	
Port	C	PASS	
Screen	C	PASS	
HCP of all sides	C	PASS	
VCP	C	PASS	
VCP of front	C	PASS	
VCP of rear	C	PASS	
VCP of left	C	PASS	
VCP of right	C	PASS	
Note:			

7. RF FIELD STRENGTH SUSCEPTIBILITY TEST

7.1. Block Diagram of Test Setup

7.1.1. Block diagram of EUT System



(EUT: Uninterruptible Power Systems)

7.1.2. Block diagram of RS test setup

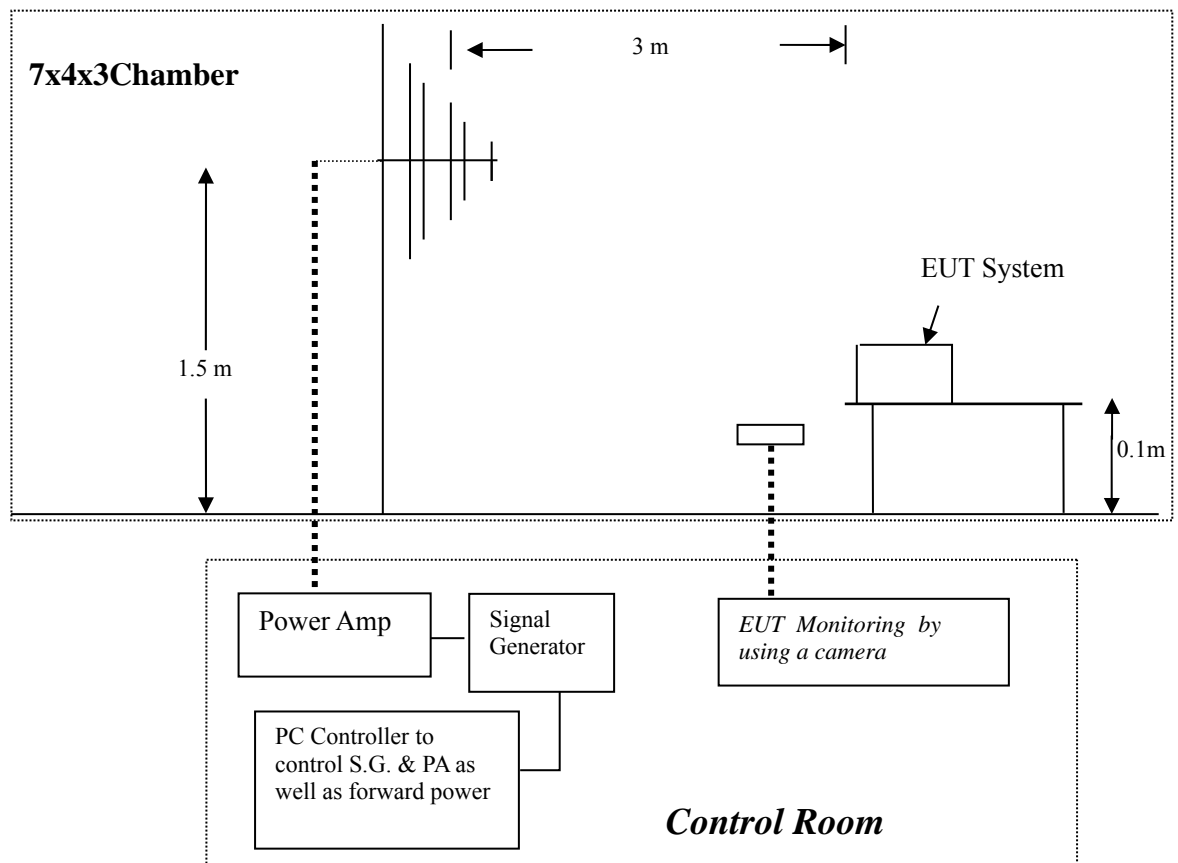

(EUT: Uninterruptible Power Systems)

7.2. Test Standard

EN 62040-2:2006 (EN 61000-4-3:2006+A1:2008+A2:2010, Severity Level: 3, 10V/m)

7.3. Severity Levels and Performance Criterion

7.3.1. Severity Levels

Level	Field Strength V/m
1.	1
2.	3
3.	10
X	Special

7.3.2. Performance Criterion: A

7.4. Operating Condition of EUT

7.4.1. Setup the EUT as shown on Section 7.1.

7.4.2. Turn on the power of all equipments.

7.4.3. Let the EUT work in test mode (Line mode, Battery mode) and test it.

7.5. Test Procedure

The EUT are placed on a table that is 0.1 meter high above the ground. The EUT is set 3 meters away from the transmitting antenna that is mounted on an antenna tower. Both horizontal and vertical polarization of the antenna is set on test. Each of the four sides of the EUT must be faced this transmitting antenna and measured individually. In order to judge the EUT performance, a CCD camera is used to monitor it. All the scanning conditions are as following:

Condition of Test	Remark
1. Fielded Strength	10V/m (Severity Level 3)
2. Radiated Signal	Modulated
3. Scanning Frequency	80-1000MHz
4. Sweep time of radiated	0.0015 Decade/s
5. Dwell Time	1 Sec.

7.6. Test Results

PASS.

Please refer to the following page.

RF Field Strength Susceptibility Test Results

EMTEK(SHENZHEN) CO., LTD.

Applicant : INVT POWER SYSTEM (SHENZHEN) CO., LTD				
EUT : Uninterruptible Power Systems		Test Date : March 06, 2012		
M/N : HR1110S		Temperature : 22°C		
Field Strength : 10 V/m		Humidity : 50 %		
Power Supply : AC 230V / 50Hz		Criterion : A		
Test Mode : Line mode/ Battery mode		Frequency Range: 80 MHz to1000 MHz		
Modulation: <input type="checkbox"/> None <input type="checkbox"/> Pulse <input checked="" type="checkbox"/> AM 1kHz 80%				
		Frequency Rang 1: 80~ 1000MHz		Frequency Rang 2: N/A
Steps		1%		
	Horizontal	Vertical	Horizontal	Vertical
Front	PASS	PASS		
Right	PASS	PASS		
Rear	PASS	PASS		
Left	PASS	PASS		
<p>Test Equipment:</p> <ol style="list-style-type: none"> 1. Signal Generator: 2023B (AEROFLEX) 2. Power Amplifier: AS0102-55 (MILMEGA)&AP32MT215 (PRANA) 3. Log.-Per.Antenna: VULP9118E(SCHWARZBECK) 4. Broad-Band Horn Antenna: BBHA 9120L3F(SCHWARZBECK) 5. RF Power Meter. Dual Channel: 4232A(BOONTON) 6. Field Strength Meter: HI-6005 (HOLADAY) 				
Note:				

8. ELECTRICAL FAST TRANSIENT/BURST IMMUNITY TEST

8.1. Block Diagram of Test Setup

8.1.1. Block Diagram of EUT System



(EUT: Uninterruptible Power Systems)

8.1.2. EFT Test Setup

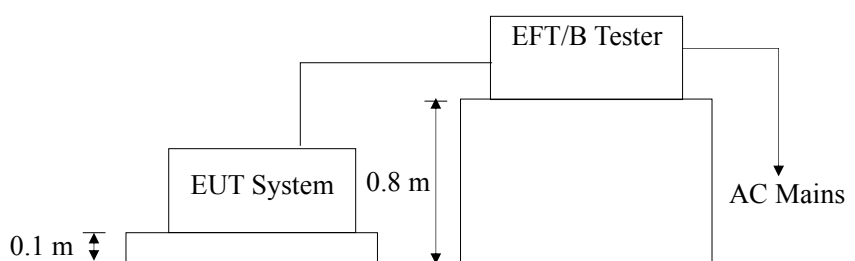

(EUT: Uninterruptible Power Systems)

8.2. Test Standard

EN 62040-2:2006 (EN 61000-4-4:2012, Severity Level: 3, 2kV)

8.3. Severity Levels and Performance Criterion

8.3.1. Severity level

Open Circuit Output Test Voltage $\pm 10\%$		
Level	On Power Supply Lines	On I/O (Input/Output) Signal data and control lines
1	0.5 kV	0.25 kV
2	1 kV	0.5 kV
3	2 kV	1 kV
4	4 kV	2 kV
X	Special	Special

8.3.2. Performance criterion: B

8.4. Operating Condition of EUT

8.4.1. Setup the EUT as shown on Section 8.1.

8.4.2. Turn on the power of all equipments.

8.4.3. Let the EUT work in test mode (Line mode) and test it.

8.5. Test Procedure

The EUT is put on the table that is 0.1 meter high above the ground. This reference ground plane shall project beyond the EUT by at least 0.1m on all sides and the minimum distance between EUT and all other conductive structure, except the ground plane beneath the EUT, shall be more than 0.5m.

8.5.1. For input and output AC power ports:

The EUT is connected to the power mains by using a coupling device that couples the EFT interference signal to AC power lines. Both polarities of the test voltage should be applied during compliance test and the duration of the test is 2 mins.

8.5.2. For signal lines and control lines ports:

No I/O ports. It's unnecessary to test.

8.5.3. For DC output line ports:

It's unnecessary to test.

8.6. Test Results

PASS.

Please refer to the following page.

Electrical Fast Transient/Burst Test Results

EMTEK(SHENZHEN) CO., LTD.

Standard : <input checked="" type="checkbox"/> EN 61000-4-4	Result: <input checked="" type="checkbox"/> PASS / <input type="checkbox"/> FAIL		
Applicant : <u>INVT POWER SYSTEM (SHENZHEN) CO., LTD</u>			
EUT : <u>Uninterruptible Power Systems</u>			
M/N : <u>HR1110S</u>			
Input Voltage: <u>AC 230V / 50Hz</u>			
Criterion : B			
Ambient Condition : <u>22 °C</u> <u>52% RH</u>			
Operation Mode: Line mode			
Line : <input checked="" type="checkbox"/> AC Mains	Line : <input type="checkbox"/> Signal <input type="checkbox"/> I/O Cable		
Coupling : <input checked="" type="checkbox"/> Direct	Coupling : <input type="checkbox"/> Capacitive		
Test Time : 120s			
Line	Test Voltage	Result(+)	Result(-)
L	2kV	PASS	PASS
N	2kV	PASS	PASS
PE	2kV	PASS	PASS
L、N	2kV	PASS	PASS
L、PE	2kV	PASS	PASS
N、PE	2kV	PASS	PASS
L、N、PE	2kV	PASS	PASS
Signal Line			
DC Line			
Note:			
Test Equipment		Burst Tester Model : PEFT 4010	

9. SURGE IMMUNITY TEST

9.1. Block Diagram of Test Setup

9.1.1. Block Diagram of EUT System



(EUT: Uninterruptible Power Systems)

9.1.2. Surge Test Setup

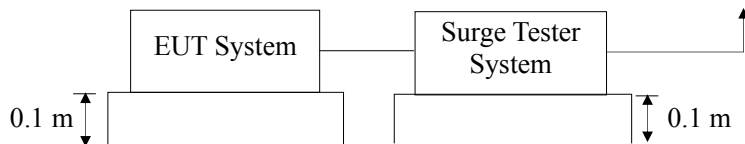

(EUT: Uninterruptible Power Systems)

9.2. Test Standard

EN 62040-2:2006

(EN 61000-4-5:2014, Severity Level: Line to Line: Level 2, 1.0kV;
Line to earth, Level 3, 2.0kV)

9.3. Severity Levels and Performance Criterion

9.3.1. Severity level

Severity Level	Open-Circuit Test Voltage kV
1	0.5
2	1.0
3	2.0
4	4.0
*	Special

9.3.2. Performance criterion: B

9.4. Operating Condition of EUT

9.4.1. Setup the EUT as shown on Section 9.1.

9.4.2. Turn on the power of all equipments.

9.4.3. Let the EUT work in test mode (Line mode) and test it.

9.5. Test Procedure

- 1) Set up the EUT and test generator as shown on Section 9.1.2.
- 2) For line to line coupling mode, provide a 1.0 kV 1.2/50us voltage surge
For line to earth coupling mode, provide a 2.0 kV 1.2/50us voltage surge.
(At open-circuit condition) and 8/20us current surge to EUT selected points.
- 3) At least 5 positive and 5 negative (polarity) tests with a maximum 1/min repetition rate are conducted during test.
- 4) Different phase angles are done individually.
- 5) Record the EUT operating situation during compliance test and decide the EUT immunity criterion for above each test.

9.6. Test Results

PASS.

Please refer to the following page.

Surge Immunity Test Results

EMTEK(SHENZHEN) CO., LTD.

Applicant : INVT POWER SYSTEM (SHENZHEN) CO., LTD

EUT : Uninterruptible Power Systems

Temperature : 22°C

M/N : HR1110S

Humidity : 51%

Power Supply : AC 230V / 50Hz

Criterion : B

Test Mode : Line mode

Location	Polarity	Phase Angle	Number of Pulse	Pulse Voltage (kV)	Result
L-N	+	0°	5	1.0	PASS
	+	90°	5	1.0	PASS
	+	180°	5	1.0	PASS
	+	270°	5	1.0	PASS
	-	0°	5	1.0	PASS
	-	90°	5	1.0	PASS
	-	180°	5	1.0	PASS
	-	270°	5	1.0	PASS
L-PE	+	0°	5	2.0	PASS
	+	90°	5	2.0	PASS
	+	180°	5	2.0	PASS
	+	270°	5	2.0	PASS
	-	0°	5	2.0	PASS
	-	90°	5	2.0	PASS
	-	180°	5	2.0	PASS
	-	270°	5	2.0	PASS
N-PE	+	0°	5	2.0	PASS
	+	90°	5	2.0	PASS
	+	180°	5	2.0	PASS
	+	270°	5	2.0	PASS
	-	0°	5	2.0	PASS
	-	90°	5	2.0	PASS
	-	180°	5	2.0	PASS
	-	270°	5	2.0	PASS

Remark:

10. INJECTED CURRENTS SUSCEPTIBILITY TEST

10.1. Block Diagram of Test Setup

10.1.1. Block Diagram of EUT System



(EUT: Uninterruptible Power Systems)

10.1.2. Block Diagram of Test Setup

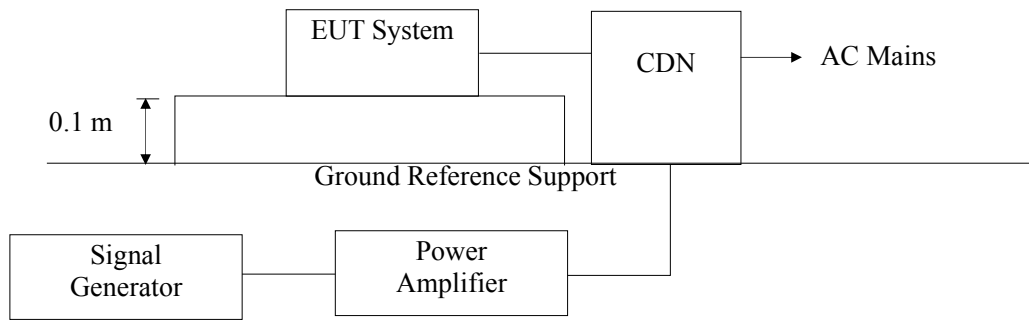

(EUT: Uninterruptible Power Systems)

10.2. Test Standard

EN 62040-2:2006

(EN 61000-4-6:2014, Severity Level: Level 3, 10V (r.m.s.), 0.15MHz ~ 80MHz)

10.3. Severity Levels and Performance Criterion

10.3.1. Severity level

Level	Field Strength V
1	1
2	3
3	10
X	Special

10.3.2. Performance criterion: A

10.4. Operating Condition of EUT

10.4.1. Setup the EUT as shown on Section 10.1.

10.4.2. Turn on the power of all equipments.

10.4.3. Let the EUT work in test mode (Line mode) and test it.

10.5. Test Procedure

- 1) Set up the EUT, CDN and test generators as shown on Section 10.1.2.
- 2) Let the EUT work in test mode and measure it.
- 3) The EUT are placed on an insulating support 0.1m high above a ground reference plane. CDN (coupling and decoupling device) is placed on the ground plane about 0.3m from EUT. Cables between CDN and EUT are as short as possible, and their height above the ground reference plane shall be between 30 and 50 mm (where possible).
- 4) The disturbance signal described below is injected to EUT through CDN.
- 5) The EUT operates within its operational mode(s) under intended climatic conditions after power on.
- 6) The frequency range is swept from 150kHz to 80MHz using 3V signal level, and with the disturbance signal 80% amplitude modulated with a 1kHz sine wave.
- 7) The rate of sweep shall not exceed $1.5 \cdot 10^{-3}$ decades/s. where the frequency is swept incrementally; the step size shall not exceed 1% of the start and thereafter 1% of the preceding frequency value.
- 8) Recording the EUT operating situation during compliance testing and decide the EUT immunity criterion.

10.6. Test Results

PASS.

Please refer to the following page.

Injected Currents Susceptibility Test Results

EMTEK(SHENZHEN) CO., LTD.

Applicant : <u>INVT POWER SYSTEM (SHENZHEN) CO., LTD</u>				
EUT : <u>Uninterruptible Power Systems</u>		Test Date: <u>March 06, 2012</u>		
M/N : <u>HR1110S</u>		Temperature : <u>22°C</u>		
Power Supply : <u>AC 230V / 50Hz</u>		Humidity : <u>58%</u>		
Test Engineer : <u>ANDY</u>				
Test Mode: Line mode				
Frequency Range (MHz)	Injected Position	Strength (Unmodulated)	Criterion	Result
0.15 ~ 80	AC Mains	10V	A	PASS
Test Mode : <u>N/A</u>				
Frequency Range (MHz)	Injected Position	Strength (Unmodulated)	Criterion	Result
Remark : 1. Modulation Signal:1kHz 80% AM Measurement Equipment : Simulator: CWS 500 (SWITZERLAND EMTEST) CDN : <input type="checkbox"/> CDN-M2 (SWITZERLAND EMTEST) <input checked="" type="checkbox"/> CDN-M3 (SWITZERLAND EMTEST)		Note:		

11.MAGNETIC FIELD SUSCEPTIBILITY TEST

11.1.Block Diagram of Test Setup

11.1.1.Block diagram of EUT System



(EUT: Uninterruptible Power Systems)

11.1.2.Magnetic field test setup

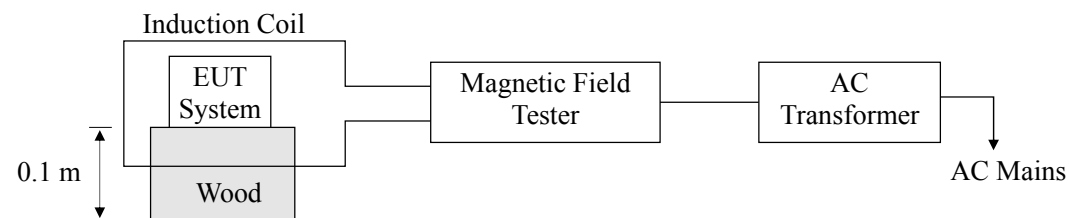

(EUT: Uninterruptible Power Systems)

11.2.Test Standard

EN 62040-2:2006

(EN 61000-4-8:2010, Severity Level: Level 4, 30 A/m)

11.3.Severity Levels and Performance Criterion

11.3.1.Severity Levels

Level	Field Strength A/m
1	1
2	3
3	10
4	30
5	100
X	Special

11.3.2.Performance Criterion: A

11.4. Operating Condition of EUT

11.4.1. Setup the EUT as shown on Section 11.1.

11.4.2. Turn on the power of all equipments.

11.4.3. Let the EUT work in test mode (Line mode, Battery mode) and test it.

11.5. Test Procedure

The EUT is placed in the middle of a induction coil (1m×1m), under which is a 1m×1m×0.1m (high) table. Both horizontal and vertical polarization of the induction coil is set on test, so that each side of the EUT is affected by the magnetic field. Also can reach the same aim by change the position of the EUT.

11.6. Test Results

PASS.

Please refer to the following page.

Magnetic Field Immunity Test Results

EMTEK(SHENZHEN) CO., LTD.

Standard: <input checked="" type="checkbox"/> EN 61000-4-8	Result: <input checked="" type="checkbox"/> PASS / <input type="checkbox"/> FAIL			
Applicant : <u>INVT POWER SYSTEM (SHENZHEN) CO., LTD</u> EUT : <u>Uninterruptible Power Systems</u> M/N : <u>HR1110S</u> Input Voltage : <u>AC230V/50Hz</u> Date of Test : <u>March 06, 2012</u> Test Engineer: <u>ANDY</u> Ambient Condition : Temp : <u>22°C</u> Humid: <u>50%</u> Criterion: A				
Operation Mode: Line mode/ Battery mode				
Test Level (A/M)	Testing Duration	Coil Orientation	Criterion	Result
30	5 mins	X	A	PASS
30	5 mins	Y	A	PASS
30	5 mins	Z	A	PASS
Operation Mode: N/A				
Test Level (A/M)	Testing Duration	Coil Orientation	Criterion	Result
Test Equipment	Magnetic Field Test: HEAFELY MAG 100.1			
Note:				

12. VOLTAGE DIPS AND INTERRUPTIONS TEST

12.1. Block Diagram of Test Setup

12.1.1. Block Diagram of EUT System



(EUT: Uninterruptible Power Systems)

12.1.2. Dips Test Setup

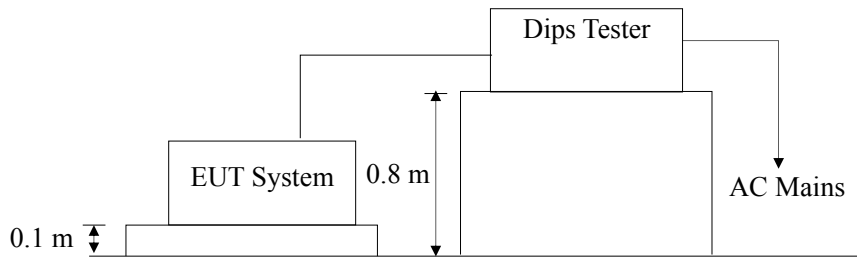

(EUT: Uninterruptible Power Systems)

12.2. Test Standard

EN 62040-2:2006 (EN 61000-4-11:2004)

12.3. Severity Levels and Performance Criterion

12.3.1. Severity level

Test Level %UT	Voltage dip and short interruptions %UT	Duration (in period)
0	100	0.5
		1
40	60	5
		10
70	30	25
		50
		*

12.3.2. Performance criterion: A

12.4. Operating Condition of EUT

12.4.1. Setup the EUT as shown on Section 12.1.

12.4.2. Turn on the power of all equipments.

12.4.3. Let the EUT work in test mode (Line mode) and test it.

12.5. Test Procedure

- 1) Set up the EUT and test generator as shown on Section 12.1.2.
- 2) The interruption is introduced at selected phase angles with specified duration.
- 3) Record any degradation of performance.

12.6. Test Results

PASS.

Please refer to the following page.

Voltage Dips and Interruptions Test Results

EMTEK(SHENZHEN) CO., LTD.

Applicant : <u>INVT POWER SYSTEM (SHENZHEN) CO., LTD</u>				
EUT : <u>Uninterruptible Power Systems</u>			Test Date : <u>March 06, 2012</u>	
M/N : <u>HR1110S</u>			Temperature : <u>22°C</u>	
Power Supply : <u>AC 230V / 50Hz</u>			Humidity : <u>50%</u>	
Test Mode: <u>Line mode</u>				
Test Level % U _T	Voltage Dips & Short Interruptions % U _T	Duration (in periods)	Criterion <input checked="" type="checkbox"/> A <input type="checkbox"/> B <input type="checkbox"/> C <input type="checkbox"/> D	Result P=PASS F=FAIL
0	100	0.5p	A	P
0	100	1 p	A	P
40	60	12 p	A	P
70	30	30 p	A	P
80	20	300 p	A	P
Test Mode : <u>N/A</u>				
Test Level % U _T	Voltage Dips & Short Interruptions % U _T	Duration (in periods)	Criterion <input type="checkbox"/> A <input type="checkbox"/> B <input type="checkbox"/> C <input type="checkbox"/> D	Result P=PASS F=FAIL
Note:				

13. LOW FREQUENCY SIGNALS TEST

13.1. Block Diagram of Test Setup

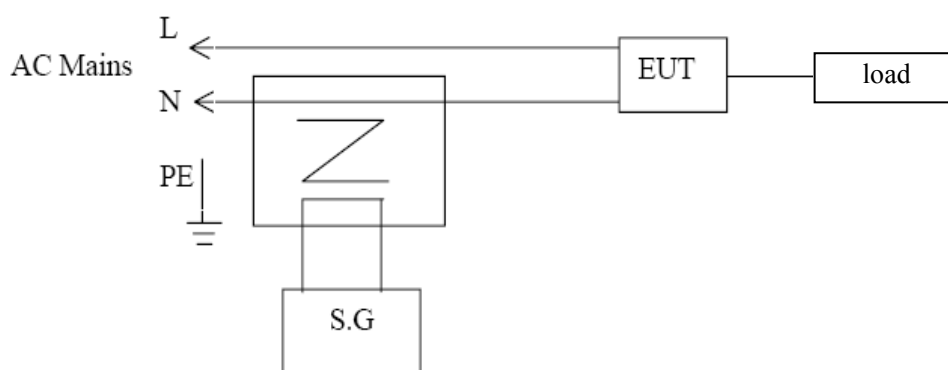

(EUT: Uninterruptible Power Systems)

13.2. Test Standard

EN 61000-2-2:2002, Performance: A

13.3. Operating Condition of EUT

- 13.3.1. Setup the EUT as shown on Section 13.1.
- 13.3.2. Turn on the power of all equipments.
- 13.3.3. Let the EUT work in test mode (Line mode) and test it.

13.4. Test Results

PASS.

Please refer to following pages.

Low Frequency Signals Test Results

EMTEK(SHENZHEN) CO., LTD.

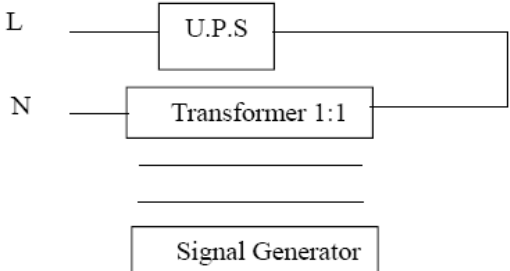
Applicant : <u>INVT POWER SYSTEM (SHENZHEN) CO., LTD</u> EUT : <u>Uninterruptible Power Systems</u> M/N : <u>HR1110S</u> Power Supply : <u>AC 230V/50Hz</u> Test Engineer : <u>KYLE</u>			Test Date: <u>March 06, 2012</u> Temperature : <u>22°C</u> Humidity : <u>58%</u> Test Mode : <u>Line Mode</u>	
Frequency Range (Hz)	Position	Strength	Result	Note
140	See Fig.1	10V(rms) Sinusoidal	PASS	
160			PASS	
200			PASS	
240			PASS	
280			PASS	
320			PASS	
360			PASS	
Note 			Test Equipment: 1. Isolation transformer Primary: Secondary=1:1 2. Signal Generator AC Source: 6530(Chroma)	

14. PHOTOGRAPHS

14.1. Photo of Conducted Emission Measurement



14.2. Photo of Radiation Emission Measurement



14.3. Photo of RF Strength Susceptibility Test



14.4. Photo of Electrical Fast Transient / Burst Test

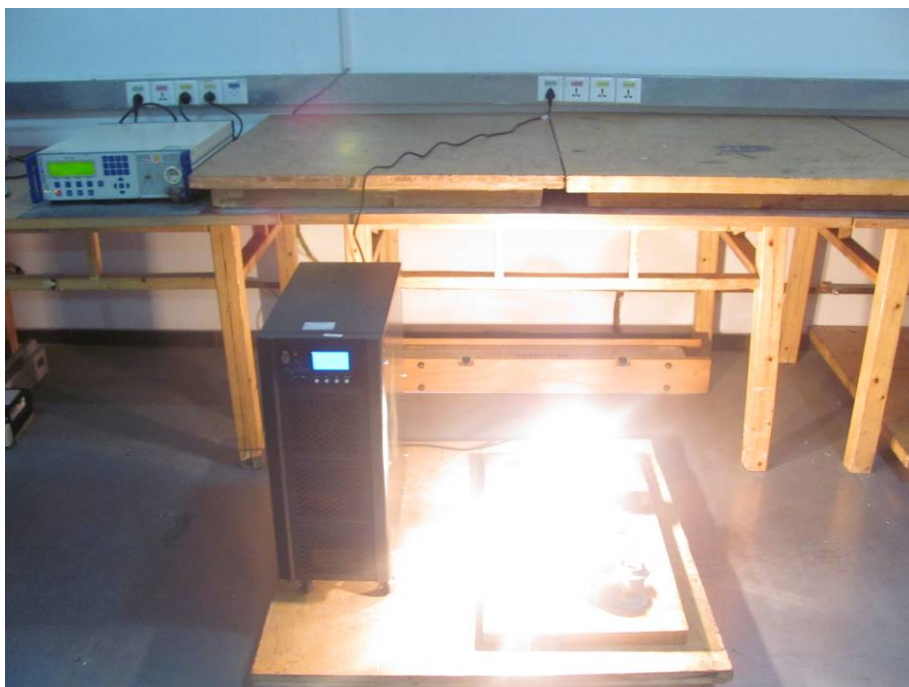

14.5.Photo of Surge Test



14.6.Photo of Injected Currents Susceptibility Test



14.7. Photo of Magnetic Field Immunity Test



14.8. Photo of Voltage Dips and Interruption Immunity Test



APPENDIX I

Model: HR110S

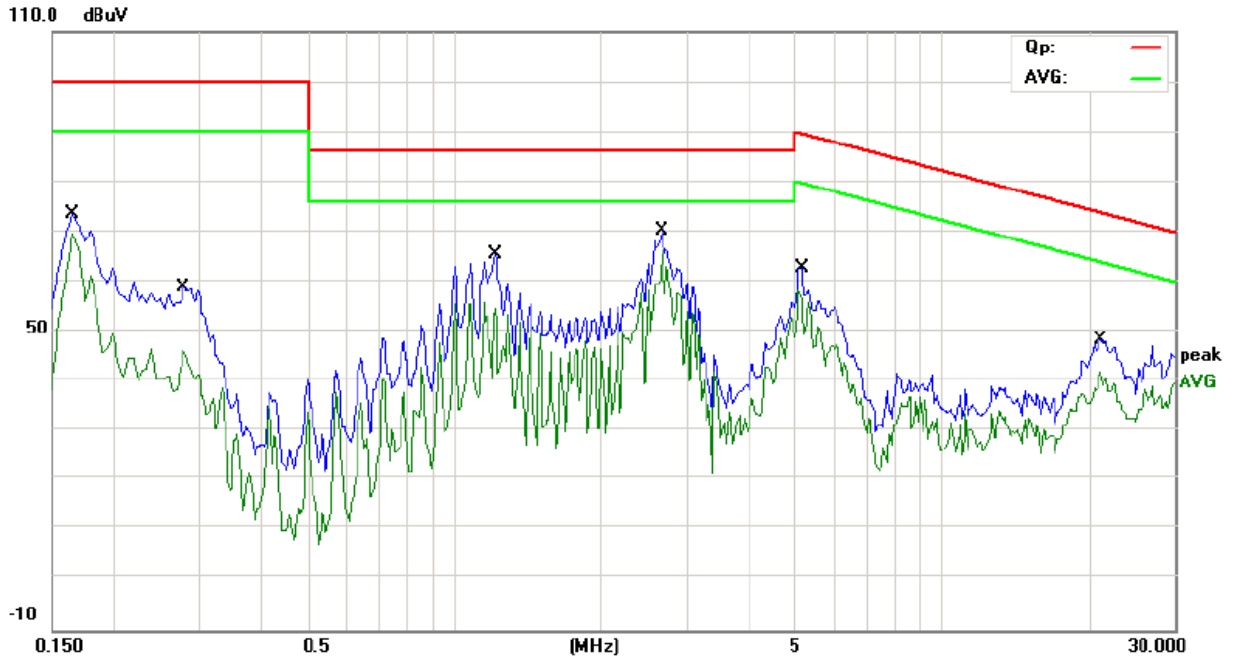

Site Conduction #2 Phase: **L1** Temperature: 26
 Limit: (CE)EN62040-2 C3_QP Power: AC 230V/50Hz Humidity: 60 %
 Mode: FULL LOAD
 Note: LINE MODE

No.	Mk.	Freq. MHz	Reading Level dBuV	Correct Factor dB	Measure- ment dBuV	Limit dBuV	Over dB	Detector	Comment
1		0.1650	73.46	0.00	73.46	100.00	-26.54	QP	
2		0.1650	69.54	0.00	69.54	90.00	-20.46	AVG	
3		0.2787	58.73	0.00	58.73	100.00	-41.27	QP	
4		0.2787	46.21	0.00	46.21	90.00	-43.79	AVG	
5		1.2161	65.55	0.00	65.55	86.00	-20.45	QP	
6		1.2161	55.70	0.00	55.70	76.00	-20.30	AVG	
7		2.6640	70.33	0.00	70.33	86.00	-15.67	QP	
8	*	2.6640	66.30	0.00	66.30	76.00	-9.70	AVG	
9		5.1662	62.85	0.00	62.85	89.64	-26.79	QP	
10		5.1662	58.26	0.00	58.26	79.64	-21.38	AVG	
11		21.1471	48.48	0.00	48.48	73.90	-25.42	QP	
12		21.1471	41.90	0.00	41.90	63.90	-22.00	AVG	

*:Maximum data x:Over limit !:over margin Comment: Factor build in receiver. Operator: xzj

Model: HR1110S

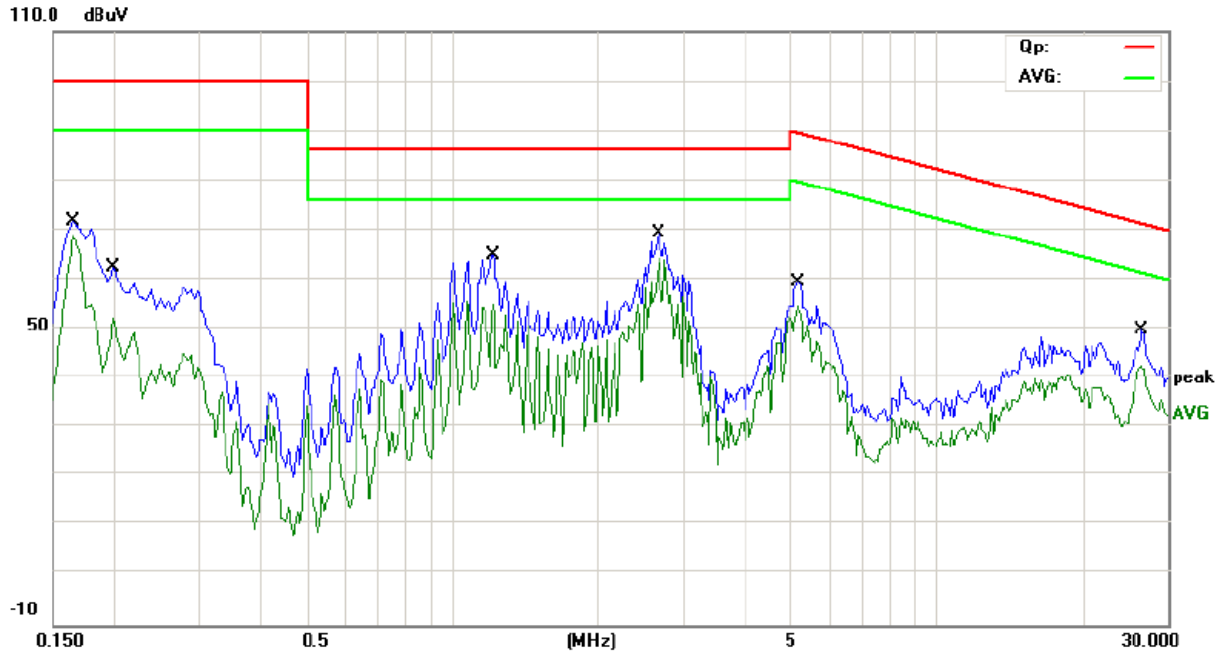

Site Conduction #2 Phase: **N** Temperature: 26
 Limit: (CE)EN62040-2 C3_QP Power: AC 230V/50Hz Humidity: 60 %
 Mode: FULL LOAD
 Note: LINE MODE

No.	Mk.	Freq.	Reading	Correct	Measure-	Limit	Over		
		MHz	Level	Factor	ment			Detector	Comment
			dBuV	dB	dBuV	dBuV	dB		
1		0.1650	71.66	0.00	71.66	100.00	-28.34	QP	
2		0.1650	68.88	0.00	68.88	90.00	-21.12	AVG	
3		0.1996	62.54	0.00	62.54	100.00	-37.46	QP	
4		0.1996	52.14	0.00	52.14	90.00	-37.86	AVG	
5		1.2161	64.97	0.00	64.97	86.00	-21.03	QP	
6		1.2161	55.69	0.00	55.69	76.00	-20.31	AVG	
7		2.6640	69.21	0.00	69.21	86.00	-16.79	QP	
8	*	2.6640	64.17	0.00	64.17	76.00	-11.83	AVG	
9		5.1662	59.59	0.00	59.59	89.64	-30.05	QP	
10		5.1662	54.74	0.00	54.74	79.64	-24.90	AVG	
11		26.5580	49.72	0.00	49.72	71.36	-21.64	QP	
12		26.5580	42.65	0.00	42.65	61.36	-18.71	AVG	

*:Maximum data x:Over limit !:over margin Comment: Factor build in receiver. Operator: xzj

Model: HR1110S

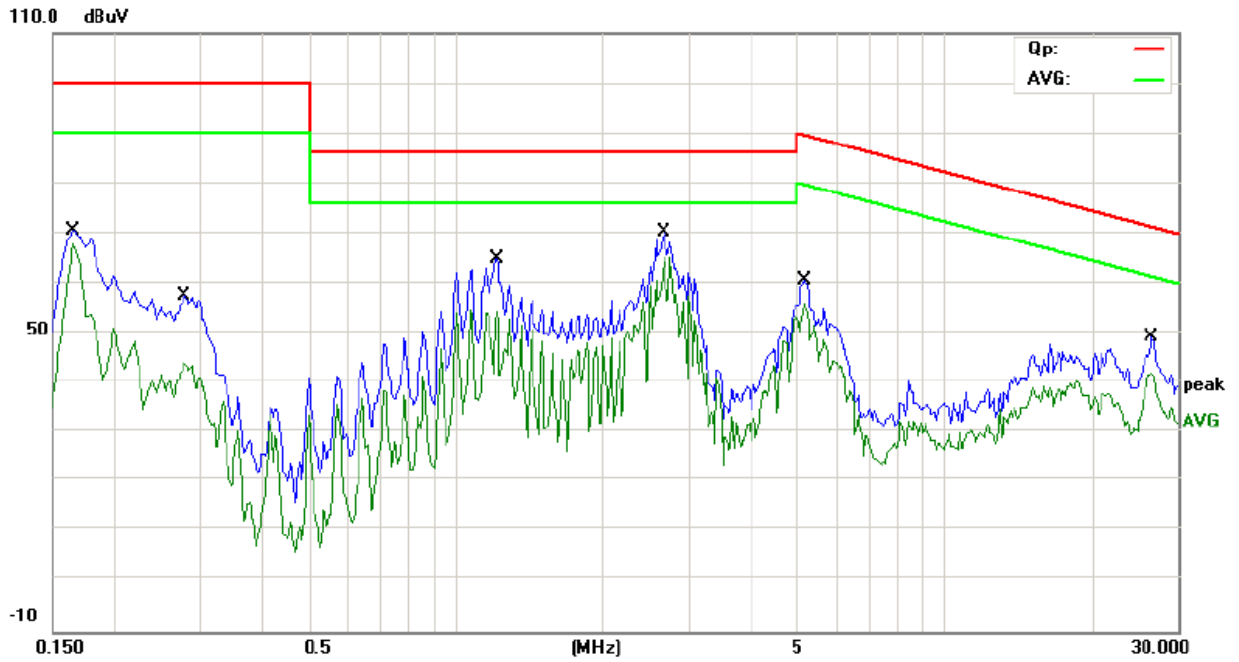

Site Conduction #2 Phase: **L1** Temperature: 26
 Limit: (CE)EN62040-2 C3_QP Power: AC 230V/50Hz Humidity: 60 %
 Mode: FULL LOAD
 Note: BAT MODE

No.	Mk.	Freq. MHz	Reading Level dBuV	Correct Factor dB	Measure- ment dBuV	Limit dBuV	Over dB	Detector	Comment
1		0.1650	70.66	0.00	70.66	100.00	-29.34	QP	
2		0.1650	67.88	0.00	67.88	90.00	-22.12	AVG	
3		0.2788	57.37	0.00	57.37	100.00	-42.63	QP	
4		0.2788	44.00	0.00	44.00	90.00	-46.00	AVG	
5		1.2162	64.97	0.00	64.97	86.00	-21.03	QP	
6		1.2162	54.69	0.00	54.69	76.00	-21.31	AVG	
7		2.6641	70.21	0.00	70.21	86.00	-15.79	QP	
8	*	2.6641	65.17	0.00	65.17	76.00	-10.83	AVG	
9		5.1663	60.59	0.00	60.59	89.63	-29.04	QP	
10		5.1663	55.74	0.00	55.74	79.63	-23.89	AVG	
11		26.5581	49.22	0.00	49.22	71.36	-22.14	QP	
12		26.5581	42.15	0.00	42.15	61.36	-19.21	AVG	

*:Maximum data x:Over limit !:over margin Comment: Factor build in receiver. Operator: xzj

Model: HR1110S

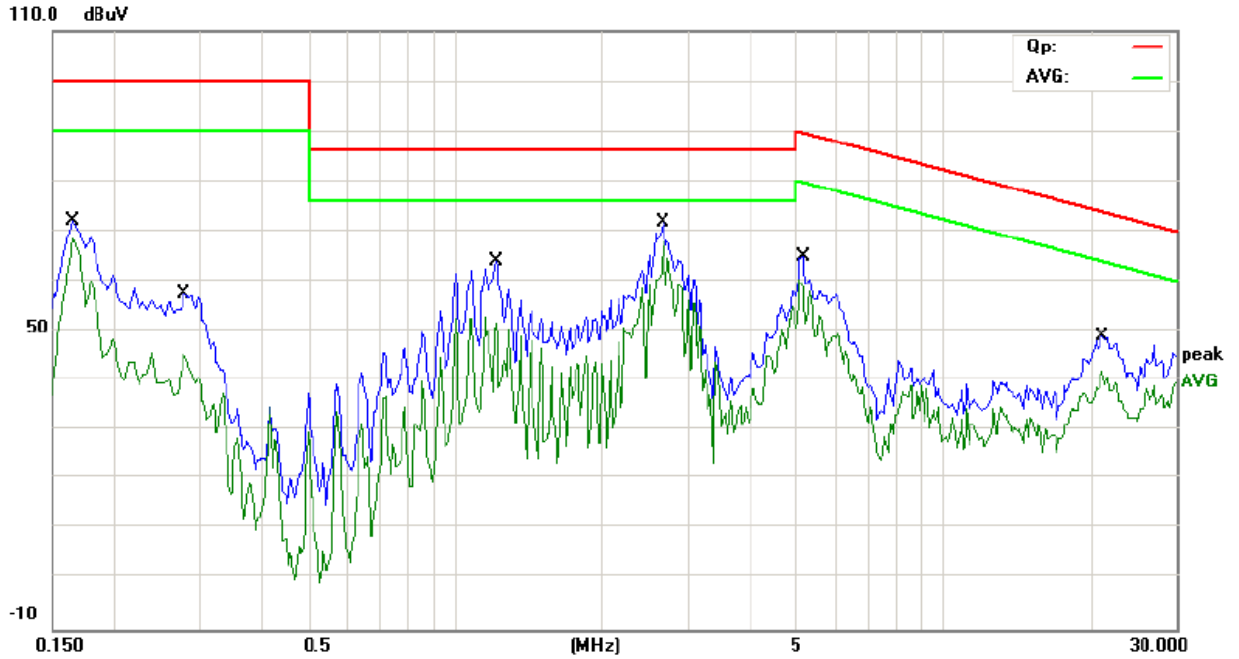

Site Conduction #2
 Limit: (CE)EN62040-2 C3_QP
 Mode: FULL LOAD
 Note: BAT MODE

Phase: **N**
 Power: AC 230V/50Hz

Temperature: 26
 Humidity: 60 %

No.	Mk.	Freq. MHz	Reading Level dBuV	Correct Factor dB	Measure- ment dBuV	Limit dBuV	Over dB	Detector	Comment
1		0.1650	71.96	0.00	71.96	100.00	-28.04	QP	
2		0.1650	68.54	0.00	68.54	90.00	-21.46	AVG	
3		0.2787	57.23	0.00	57.23	100.00	-42.77	QP	
4		0.2787	45.21	0.00	45.21	90.00	-44.79	AVG	
5		1.2161	64.05	0.00	64.05	86.00	-21.95	QP	
6		1.2161	52.70	0.00	52.70	76.00	-23.30	AVG	
7		2.6640	71.83	0.00	71.83	86.00	-14.17	QP	
8	*	2.6640	67.80	0.00	67.80	76.00	-8.20	AVG	
9		5.1662	64.85	0.00	64.85	89.64	-24.79	QP	
10		5.1662	60.26	0.00	60.26	79.64	-19.38	AVG	
11		21.1471	48.98	0.00	48.98	73.90	-24.92	QP	
12		21.1471	41.90	0.00	41.90	63.90	-22.00	AVG	

*:Maximum data x:Over limit !:over margin Comment: Factor build in receiver. Operator: xzj

Model: HR1106L

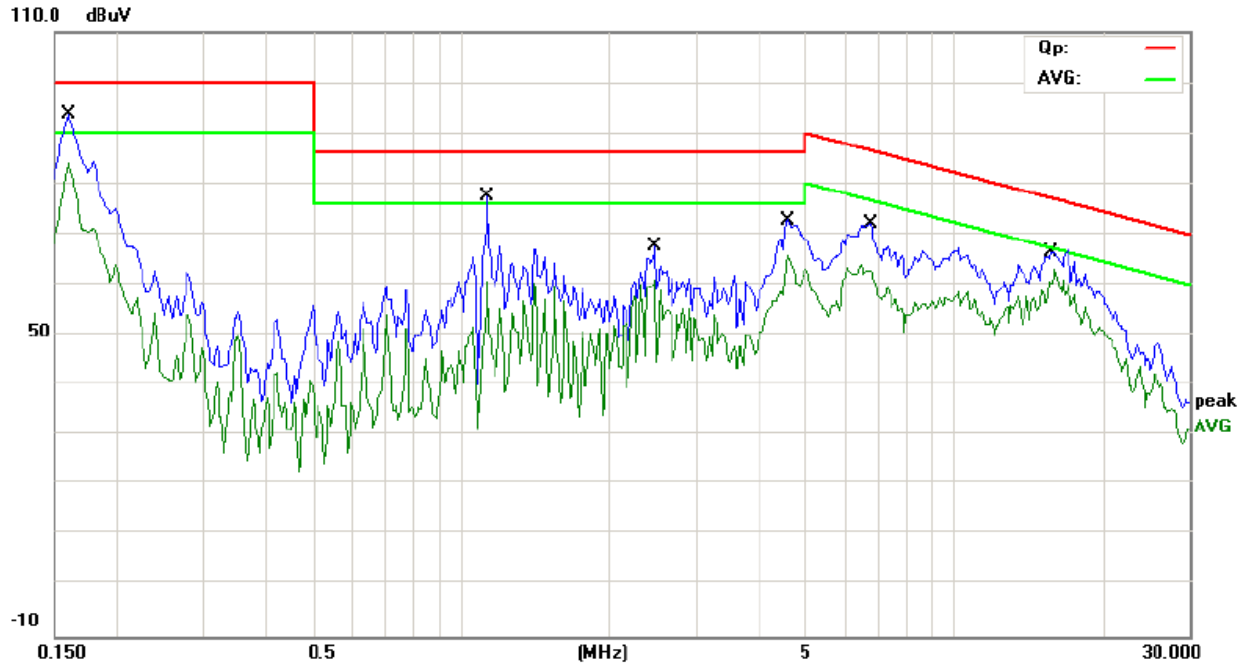

Site Conduction #2

Phase: **L1**

Temperature: 26

Limit: (CE)EN62040-2 C3_QP

Power: AC 230V/50Hz

Humidity: 60 %

Mode: FULL LOAD

Note: LINE MODE

No.	Mk.	Freq. MHz	Reading Level dBuV	Correct Factor dB	Measure- ment dBuV	Limit dBuV	Over dB	Detector	Comment
1		0.1597	93.73	0.00	93.73	100.00	-6.27	QP	
2		0.1597	84.15	0.00	84.15	90.00	-5.85	AVG	
3		1.1290	77.38	0.00	77.38	86.00	-8.62	QP	
4		1.1290	60.55	0.00	60.55	76.00	-15.45	AVG	
5		2.4735	67.64	0.00	67.64	86.00	-18.36	QP	
6		2.4735	60.93	0.00	60.93	76.00	-15.07	AVG	
7		4.5980	72.80	0.00	72.80	86.00	-13.20	QP	
8		4.5980	65.81	0.00	65.81	76.00	-10.19	AVG	
9		6.7690	72.05	0.00	72.05	86.62	-14.57	QP	
10		6.7690	64.03	0.00	64.03	76.62	-12.59	AVG	
11		15.7180	66.47	0.00	66.47	77.22	-10.75	QP	
12	*	15.7180	63.02	0.00	63.02	67.22	-4.20	AVG	

*:Maximum data x:Over limit !:over margin Comment: Factor build in receiver. Operator: xzj

Model: HR1106L

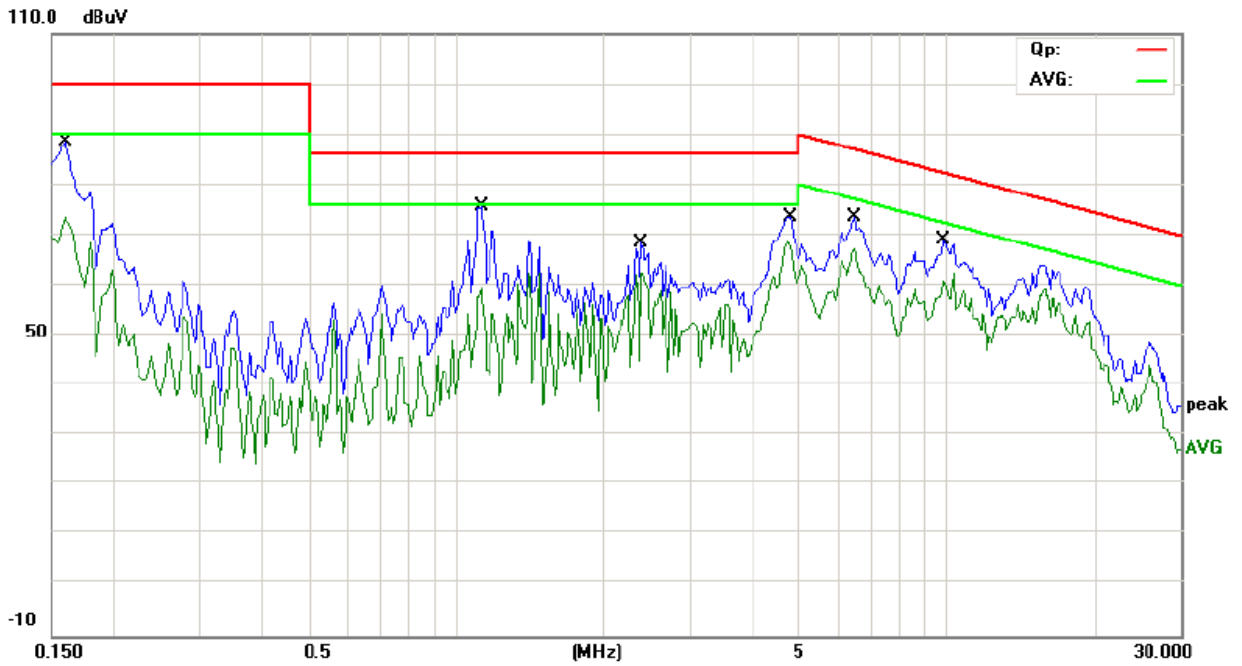

Site Conduction #2 Phase: **N** Temperature: 26
 Limit: (CE)EN62040-2 C3_QP Power: AC 230V/50Hz Humidity: 60 %
 Mode: FULL LOAD
 Note: LINE MODE

No.	Mk.	Freq. MHz	Reading Level dBuV	Correct Factor dB	Measure- ment dBuV	Limit dBuV	Over dB	Detector	Comment
1		0.1597	88.65	0.00	88.65	100.00	-11.35	QP	
2		0.1597	73.50	0.00	73.50	90.00	-16.50	AVG	
3		1.1230	75.55	0.00	75.55	86.00	-10.45	QP	
4		1.1230	59.34	0.00	59.34	76.00	-16.66	AVG	
5		2.3835	68.52	0.00	68.52	86.00	-17.48	QP	
6		2.3835	62.59	0.00	62.59	76.00	-13.41	AVG	
7		4.7968	73.63	0.00	73.63	86.00	-12.37	QP	
8	*	4.7968	68.74	0.00	68.74	76.00	-7.26	AVG	
9		6.4881	73.60	0.00	73.60	87.09	-13.49	QP	
10		6.4881	67.26	0.00	67.26	77.09	-9.83	AVG	
11		9.9130	68.65	0.00	68.65	82.36	-13.71	QP	
12		9.9130	62.40	0.00	62.40	72.36	-9.96	AVG	

*:Maximum data x:Over limit !:over margin Comment: Factor build in receiver. Operator: xzj

Model: HR1106L

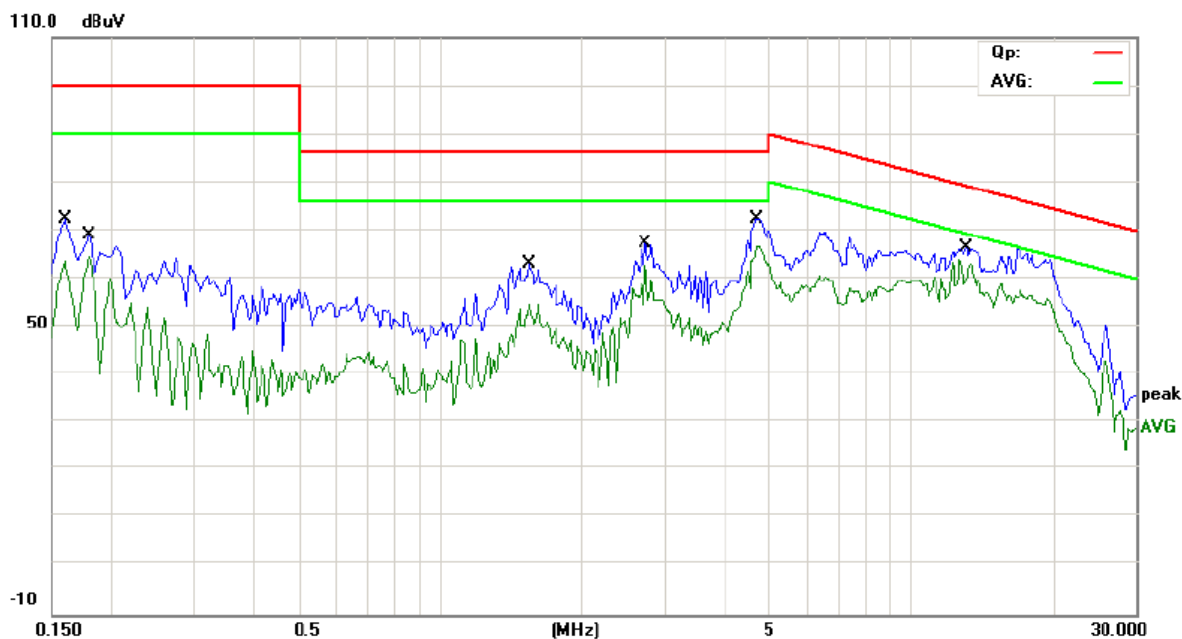

Site Conduction #2

Phase: **L1**

Temperature: 26

Limit: (CE)EN62040-2 C3_QP

Power: AC 230V/50Hz

Humidity: 60 %

Mode: FULL LOAD

Note: BAT MODE

No.	Mk.	Freq. MHz	Reading Level dBuV	Correct Factor dB	Measure- ment dBuV	Limit dBuV	Over dB	Detector	Comment
1		0.1597	72.26	0.00	72.26	100.00	-27.74	QP	
2		0.1597	63.79	0.00	63.79	90.00	-26.21	AVG	
3		0.1796	69.02	0.00	69.02	100.00	-30.98	QP	
4		0.1796	64.43	0.00	64.43	90.00	-25.57	AVG	
5		1.5436	63.11	0.00	63.11	86.00	-22.89	QP	
6		1.5436	54.76	0.00	54.76	76.00	-21.24	AVG	
7		2.7212	67.33	0.00	67.33	86.00	-18.67	QP	
8		2.7212	62.66	0.00	62.66	76.00	-13.34	AVG	
9		4.6963	72.46	0.00	72.46	86.00	-13.54	QP	
10		4.6963	66.70	0.00	66.70	76.00	-9.30	AVG	
11		13.0573	66.33	0.00	66.33	79.29	-12.96	QP	
12	*	13.0573	63.57	0.00	63.57	69.29	-5.72	AVG	

*:Maximum data x:Over limit !:over margin Comment: Factor build in receiver. Operator: xzj

Model: HR1106L

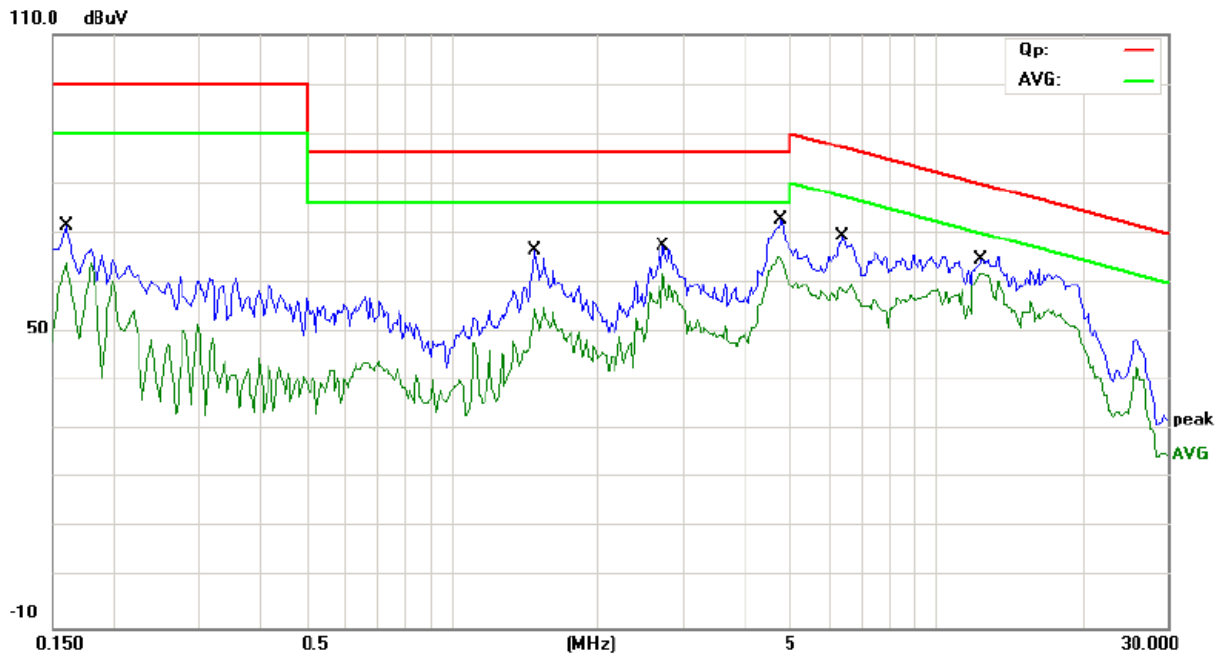

Site Conduction #2 Phase: **N** Temperature: 26
 Limit: (CE)EN62040-2 C3_QP Power: AC 230V/50Hz Humidity: 60 %
 Mode: FULL LOAD
 Note: BAT MODE

No.	Mk.	Freq. MHz	Reading Level dBuV	Correct Factor dB	Measure- ment dBuV	Limit dB	Over dB	Detector	Comment
1		0.1597	71.48	0.00	71.48	100.00	-28.52	QP	
2		0.1597	63.92	0.00	63.92	90.00	-26.08	AVG	
3		1.4874	65.94	0.00	65.94	86.00	-20.06	QP	
4		1.4874	55.07	0.00	55.07	76.00	-20.93	AVG	
5		2.7212	67.19	0.00	67.19	86.00	-18.81	QP	
6		2.7212	61.84	0.00	61.84	76.00	-14.16	AVG	
7		4.7716	72.60	0.00	72.60	86.00	-13.40	QP	
8		4.7716	65.20	0.00	65.20	76.00	-10.80	AVG	
9		6.4198	69.22	0.00	69.22	87.21	-17.99	QP	
10		6.4198	59.83	0.00	59.83	77.21	-17.38	AVG	
11		12.3834	64.64	0.00	64.64	79.88	-15.24	QP	
12	*	12.3834	61.88	0.00	61.88	69.88	-8.00	AVG	

*:Maximum data x:Over limit !:over margin Comment: Factor build in receiver. Operator: xzj

APPENDIX II

Model: HR110S

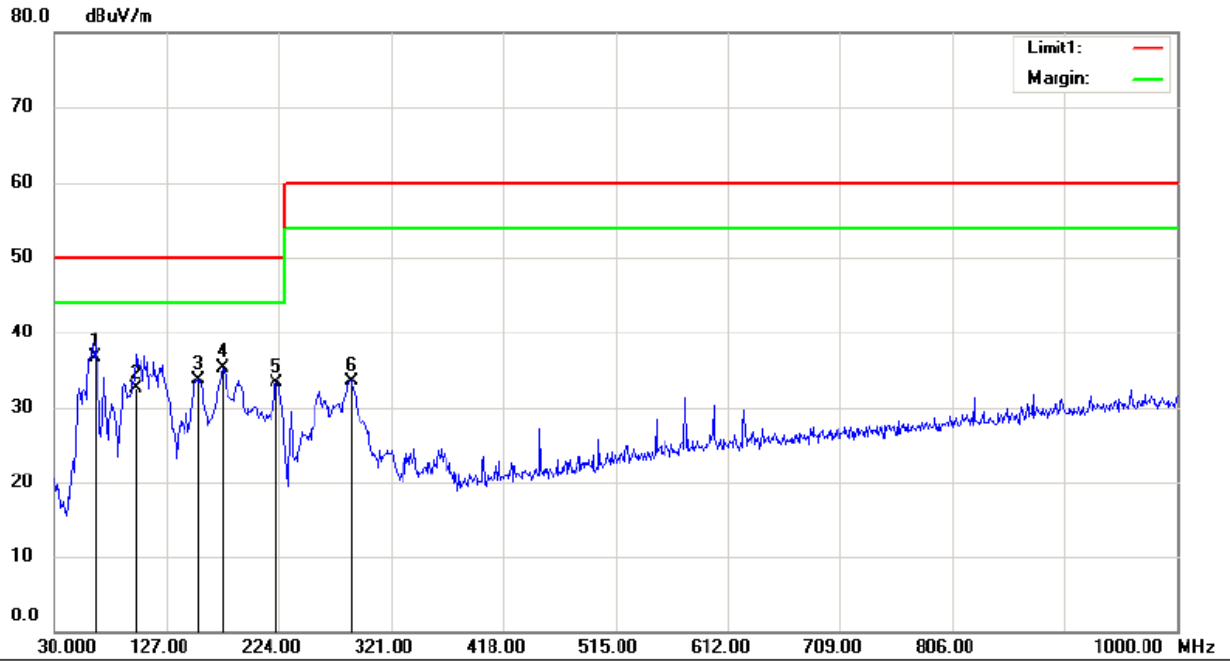

Site site #1 Polarization: **Vertical** Temperature: 26
 Limit: EN62040-2 C3 10M Power: AC 230V/50Hz Humidity: 50 %
 Mode:FULL LOAD
 Note: LINE MODE

No.	Mk.	Freq. MHz	Reading Level dBuV	Correct Factor dB	Measure- ment dBuV/m	Limit dBuV/m	Over dB	Antenna Height cm	Table Degree degree	Comment
1	*	65.8900	60.42	-23.62	36.80	50.00	-13.20	QP		
2		99.8400	53.09	-20.49	32.60	50.00	-17.40	QP		
3		154.1600	57.92	-24.30	33.62	50.00	-16.38	QP		
4		175.5000	58.28	-23.04	35.24	50.00	-14.76	QP		
5		222.0600	53.66	-20.37	33.29	50.00	-16.71	QP		
6		286.0800	51.56	-17.96	33.60	60.00	-26.40	QP		

*:Maximum data x:Over limit !:over margin

Operator: WOLF

Model: HR1110S

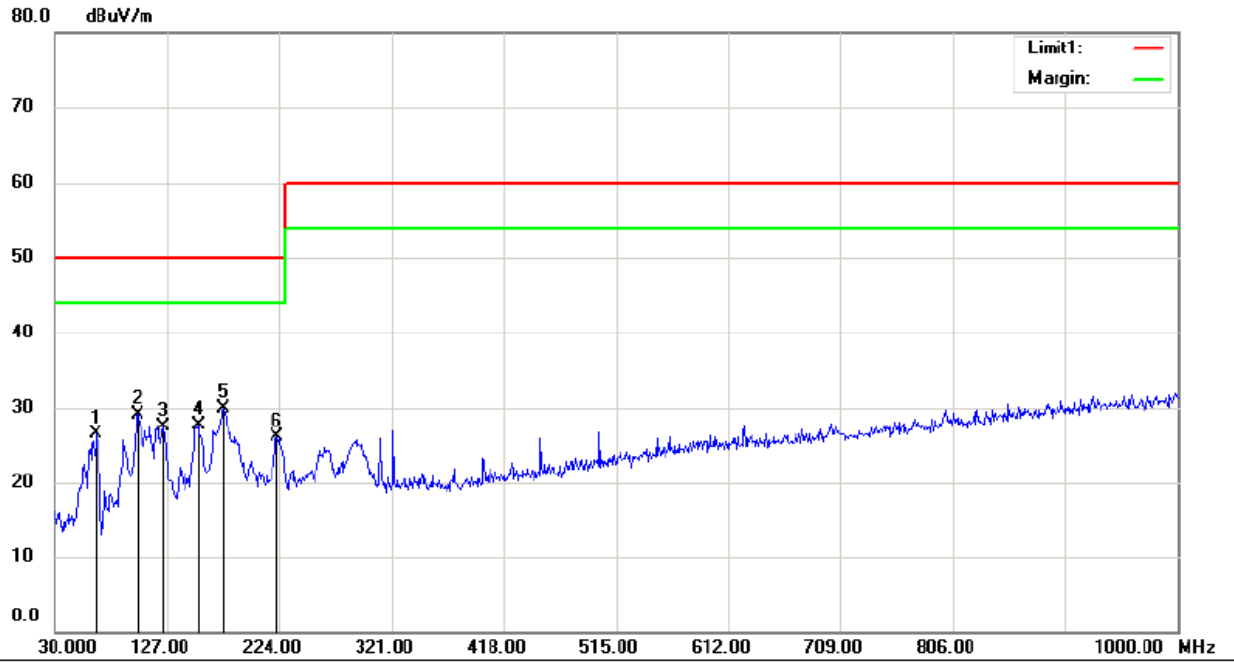

Site site #1 Polarization: **Horizontal** Temperature: 26
 Limit: EN62040-2 C3 10M Power: AC 230V/50Hz Humidity: 50 %
 Mode: FULL LOAD
 Note: LINE MODE

No.	Mk.	Freq. MHz	Reading Level dBuV	Correct Factor dB	Measure- ment dBuV/m	Limit dBuV/m	Over dB	Antenna Height cm	Table Degree degree	Comment
1		65.8900	50.10	-23.62	26.48	50.00	-23.52	QP		
2		101.7800	49.70	-20.63	29.07	50.00	-20.93	QP		
3		123.1200	50.95	-23.43	27.52	50.00	-22.48	QP		
4		154.1600	51.93	-24.30	27.63	50.00	-22.37	QP		
5	*	175.5000	52.87	-23.04	29.83	50.00	-20.17	QP		
6		222.0600	46.39	-20.37	26.02	50.00	-23.98	QP		

*:Maximum data x:Over limit !:over margin

Operator: WOLF

Model: HR1110S

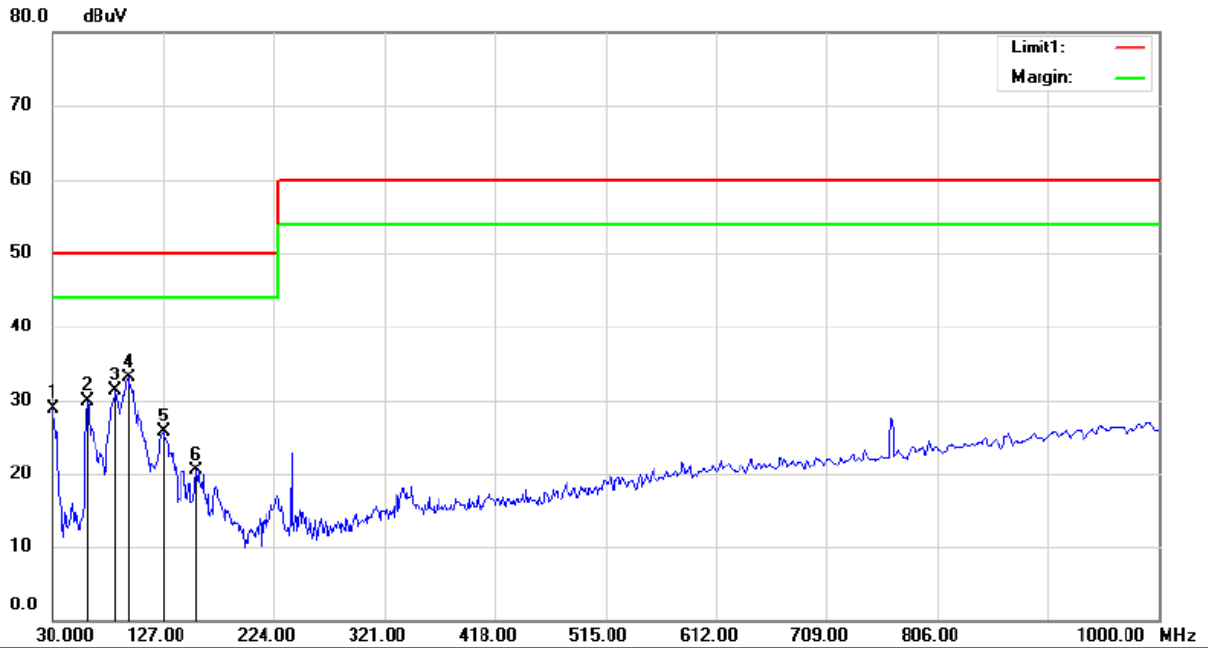

Site site #1 Polarization: *Vertical* Temperature: 26
 Limit: EN62040-2 C3 10M Power: AC 230V/50Hz Humidity: 50 %
 Mode:FULL LOAD
 Note: BAT MODE

No.	Mk.	Freq.	Reading	Correct	Measure-	Limit	Over	Antenna	Table	
		MHz	Level	Factor	ment			Height	Degree	Comment
			dBuV	dB	dBuV	dBuV	dB	cm	degree	
1		30.6380	51.01	-22.04	28.97	50.00	-21.03	QP		
2		60.7044	51.52	-21.61	29.91	50.00	-20.09	QP		
3		85.2980	54.70	-23.42	31.28	50.00	-18.72	QP		
4	*	96.0986	53.83	-20.79	33.04	50.00	-16.96	QP		
5		127.2176	49.75	-23.97	25.78	50.00	-24.22	QP		
6		156.4576	44.60	-24.15	20.45	50.00	-29.55	QP		

*:Maximum data x:Over limit !:over margin

Operator: WOLF

Model: HR1110S

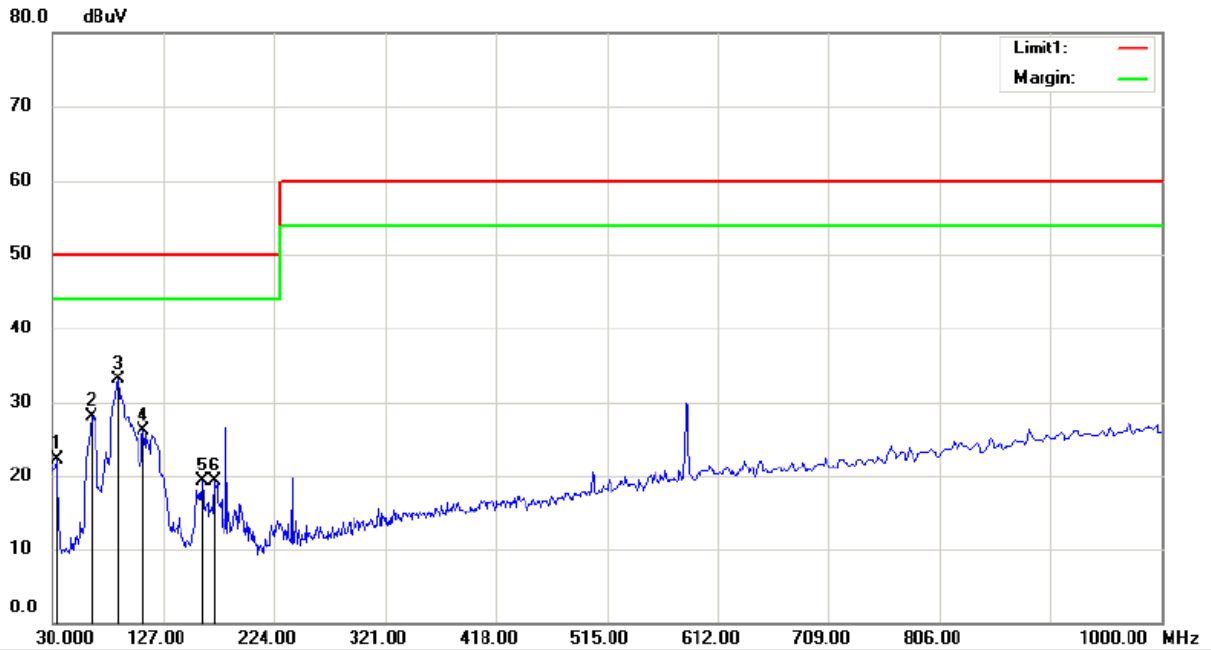

Site site #1 Polarization: **Horizontal** Temperature: 26
 Limit: EN62040-2 C3 10M Power: AC 230V/50Hz Humidity: 50 %
 Mode: FULL LOAD
 Note: BAT MODE

No.	Mk.	Freq. MHz	Reading Level dBuV	Correct Factor dB	Measure- ment dBuV	Limit dBuV	Over dB	Detector	Antenna Height cm	Table Degree	Comment
1		34.1560	44.31	-22.03	22.28	50.00	-27.72	QP			
2		64.8864	51.40	-23.24	28.16	50.00	-21.84	QP			
3	*	87.7246	55.72	-22.63	33.09	50.00	-16.91	QP			
4		109.7960	47.40	-21.31	26.09	50.00	-23.91	QP			
5		161.4740	43.08	-23.87	19.21	50.00	-30.79	QP			
6		171.9945	42.74	-23.34	19.40	50.00	-30.60	QP			

*:Maximum data x:Over limit !:over margin

Operator: WOLF

Model: HR1106L

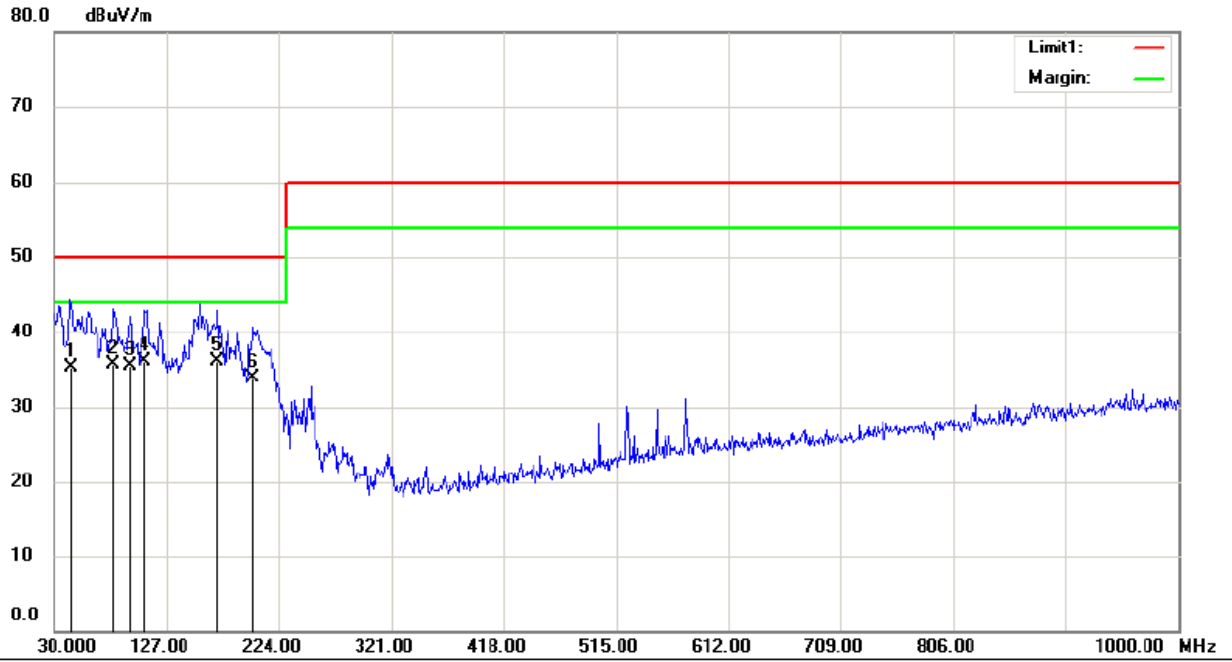

Site site #1 Polarization: **Vertical** Temperature: 26
 Limit: EN62040-2 C3 10M Power: AC 230V/50Hz Humidity: 50 %
 Mode:FULL LOAD
 Note: LINE MODE

No.	Mk.	Freq. MHz	Reading Level dBuV	Correct Factor dB	Measure- ment dBuV/m	Limit dBuV/m	Over dB	Antenna Height cm	Table Degree	Detector	Comment
1		44.5500	56.06	-20.66	35.40	50.00	-14.60			QP	
2		81.4100	60.61	-24.81	35.80	50.00	-14.20			QP	
3		94.9900	56.49	-20.89	35.60	50.00	-14.40			QP	
4	*	108.5700	57.40	-21.20	36.20	50.00	-13.80			QP	
5		170.6500	59.65	-23.45	36.20	50.00	-13.80			QP	
6		201.6900	55.26	-21.36	33.90	50.00	-16.10			QP	

*:Maximum data x:Over limit !:over margin

Operator: WOLF

Model: HR1106L

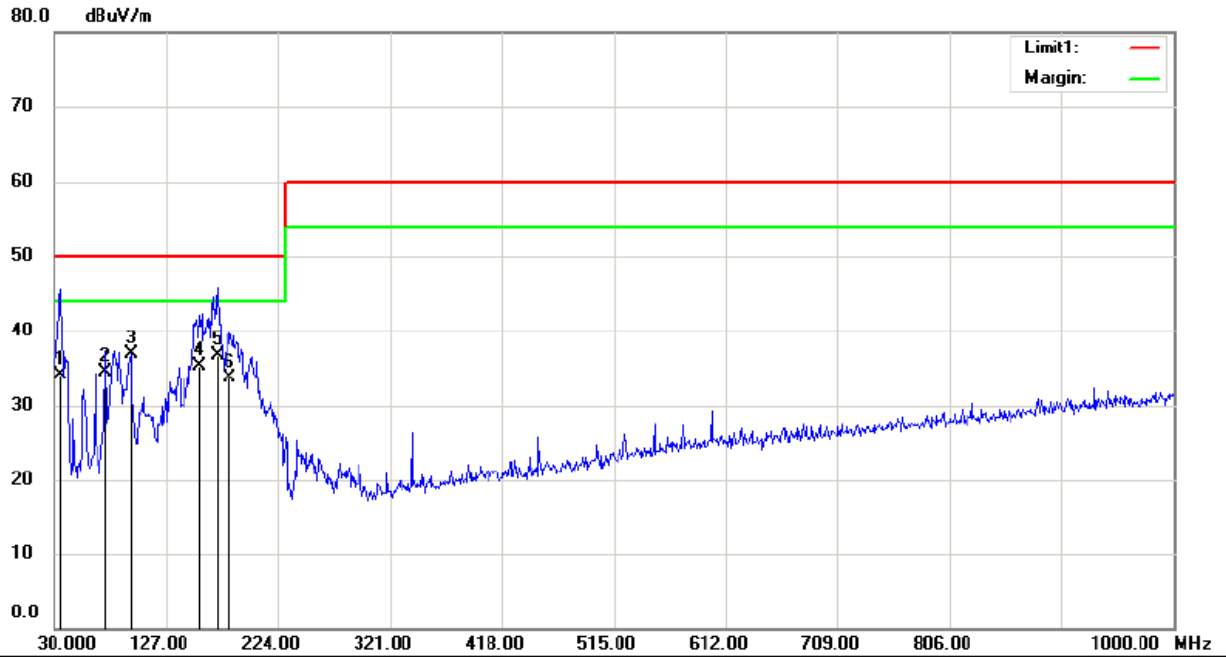

Site site #1 Polarization: **Horizontal** Temperature: 26
 Limit: EN62040-2 C3 10M Power: AC 230V/50Hz Humidity: 50 %

Mode:FULL LOAD
 Note: LINE MODE

No.	Mk.	Freq.	Reading Level	Correct Factor	Measurement	Limit	Over	Antenna Height	Table Degree	
		MHz	dBuV	dB	dBuV/m	dBuV/m	dB	cm	degree	Comment
1		35.8200	56.01	-21.81	34.20	50.00	-15.80			QP
2		74.6200	60.63	-26.03	34.60	50.00	-15.40			QP
3	*	95.9600	57.71	-20.80	36.91	50.00	-13.09			QP
4		156.1000	59.47	-24.17	35.30	50.00	-14.70			QP
5		171.6200	60.07	-23.37	36.70	50.00	-13.30			QP
6		182.2900	56.24	-22.44	33.80	50.00	-16.20			QP

*:Maximum data x:Over limit !:over margin

Operator: WOLF

Model: HR1106L

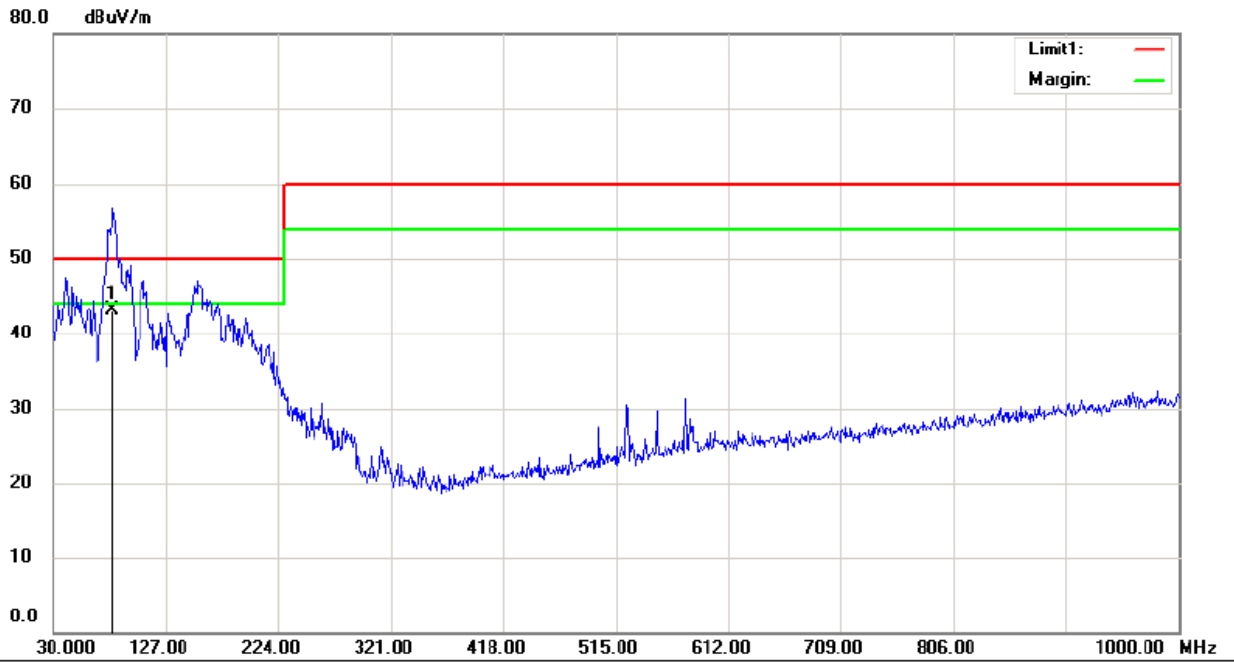

Site site #1 Polarization: **Vertical** Temperature: 26
 Limit: EN62040-2 C3 10M Power: AC 230V/50Hz Humidity: 50 %
 Mode: FULL LOAD
 Note: BAT MODE

No.	Mk.	Freq.	Reading Level	Correct Factor	Measurement	Limit	Over	Antenna Height	Table Degree		
		MHz	dBuV	dB	dBuV/m	dBuV/m	dB	Detector	cm	degree	Comment
1	*	81.4100	68.01	-24.81	43.20	50.00	-6.80	QP			

*:Maximum data x:Over limit !:over margin

Operator: WOLF

Model: HR1106L

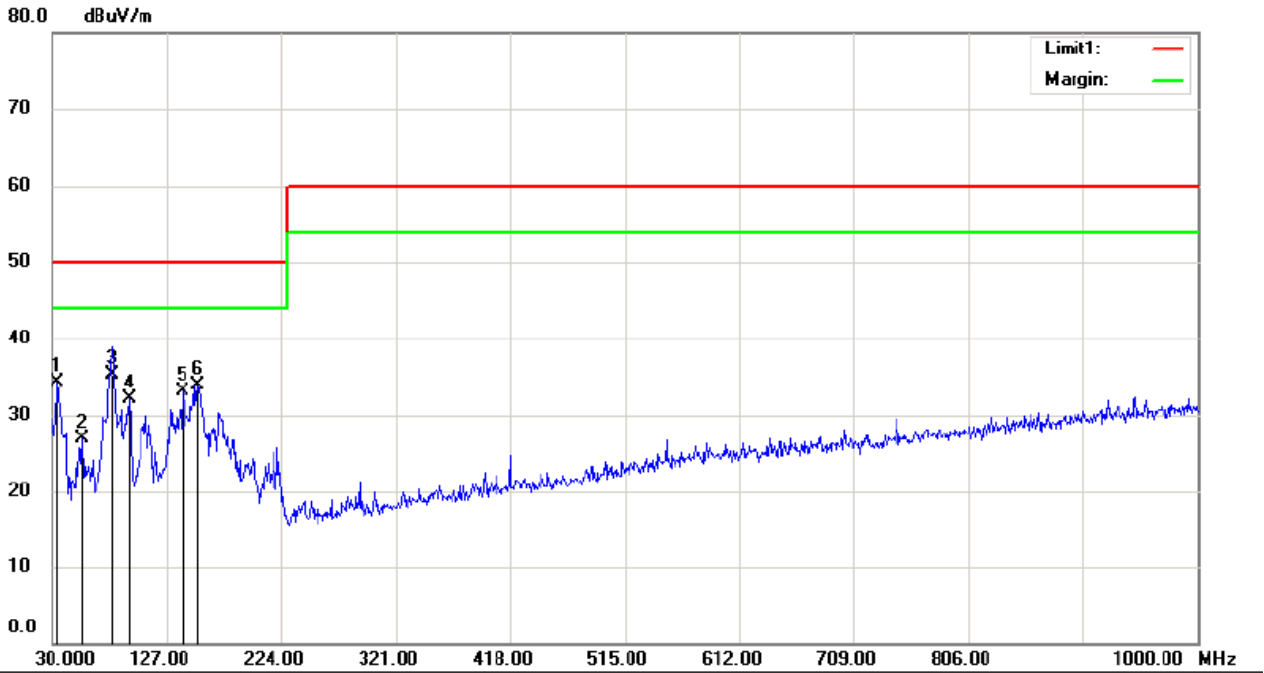

Site site #1 Polarization: **Horizontal** Temperature: 26
 Limit: EN62040-2 C3 10M Power: AC 230V/50Hz Humidity: 50 %
 Mode: FULL LOAD
 Note: BAT MODE

No.	Mk.	Freq.	Reading Level	Correct Factor	Measurement	Limit	Over	Antenna Height	Table Degree	
		MHz	dBuV	dB	dBuV/m	dBuV/m	dB	cm	degree	Comment
1		34.8500	56.25	-22.03	34.22	50.00	-15.78			QP
2		55.2200	47.95	-21.07	26.88	50.00	-23.12			QP
3	*	81.4100	60.21	-24.81	35.40	50.00	-14.60			QP
4		94.9900	52.98	-20.89	32.09	50.00	-17.91			QP
5		140.5800	58.02	-24.84	33.18	50.00	-16.82			QP
6		153.1900	58.26	-24.35	33.91	50.00	-16.09			QP

*:Maximum data x:Over limit !:over margin

Operator: WOLF

APPENDIX III (Photos of EUT)

Model: HR1110S





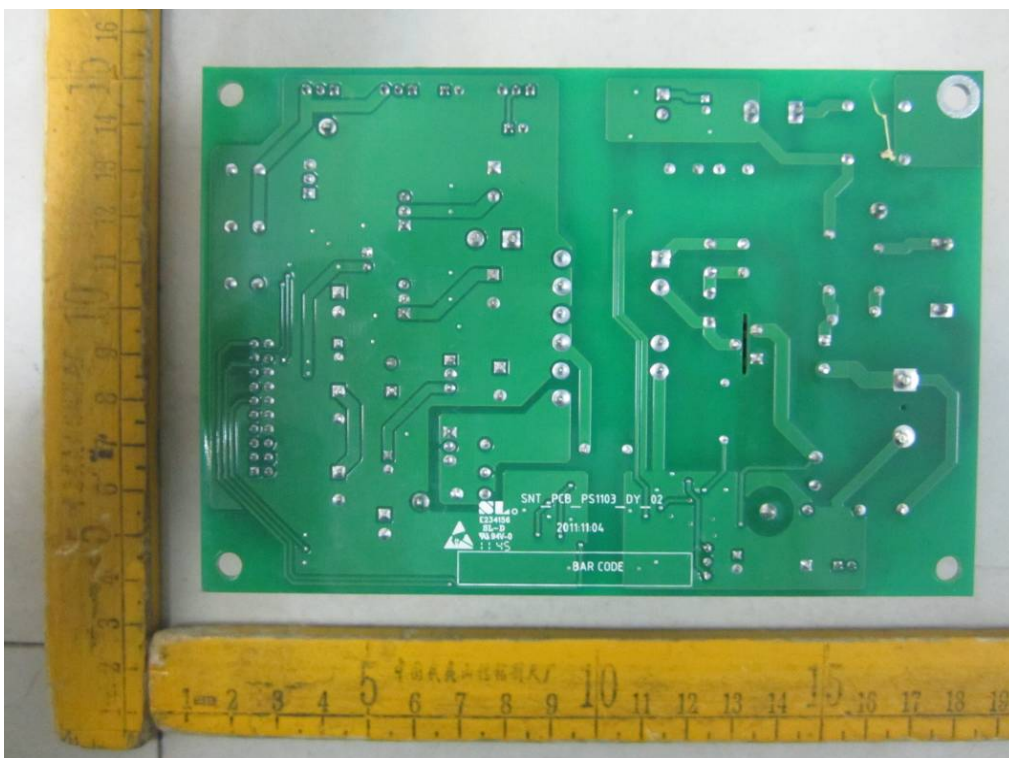
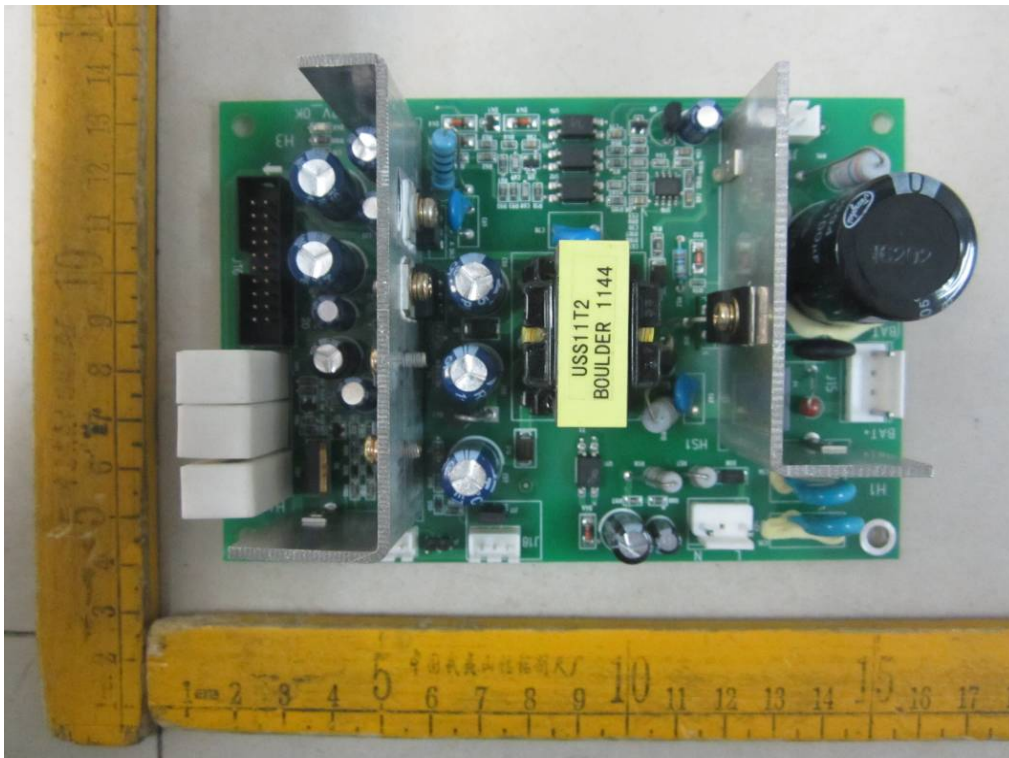

Model: HR1106L





