

288pin ECC Unbuffered DIMM based on 8Gb B-die

78FBGA with Lead-Free & Halogen-Free
(RoHS compliant)

datasheet

SAMSUNG ELECTRONICS RESERVES THE RIGHT TO CHANGE PRODUCTS, INFORMATION AND SPECIFICATIONS WITHOUT NOTICE.

Products and specifications discussed herein are for reference purposes only. All information discussed herein is provided on an "AS IS" basis, without warranties of any kind.

This document and all information discussed herein remain the sole and exclusive property of Samsung Electronics. No license of any patent, copyright, mask work, trademark or any other intellectual property right is granted by one party to the other party under this document, by implication, estoppel or otherwise.

Samsung products are not intended for use in life support, critical care, medical, safety equipment, or similar applications where product failure could result in loss of life or personal or physical harm, or any military or defense application, or any governmental procurement to which special terms or provisions may apply.

For updates or additional information about Samsung products, contact your nearest Samsung office.

All brand names, trademarks and registered trademarks belong to their respective owners.

© 2018 Samsung Electronics Co., Ltd. All rights reserved.

Revision History

<u>Revision No.</u>	<u>History</u>	<u>Draft Date</u>	<u>Remark</u>	<u>Editor</u>
0.5	- First SPEC release - Separate ECC and Non ECC datasheets.	15th Nov, 2017	Preliminary	J.Y.Bae J.H.Han
1.0	- Final datasheet. - Correct typo. - Correct speed bin table numbering. - Add DRAM Package Electrical Specifications (x4/x8) table.	13th Dec, 2017	Final	J.Y.Bae J.H.Han
1.1	- Correct typo in Key features. - Update Single-ended AC & DC Input Levels for Command and Address table. - Update Differential AC and DC Input Levels table. - Update Cross point voltage for differential input signals (CK) table. - Update Differential AC and DC Input Levels for DQS table. - Update Differential Input Level for DQS_t, DQS_c table. - Update Differential Input Slew Rate for DQS_t, DQS_c table. - Update Output Driver DC Electrical Characteristics, assuming RZQ=240ohm; entire operating temperature range; after proper ZQ calibration table. - Update AC Timing table for 2666Mbps. 1. tDLLK : 854 -> 1024 [nCK]. 2. tXPR_GEAR Min. : TBD -> tXPR 3. tXS_GEAR Min. : TBD -> tXS 4. tSYNC_GEAR Min. : TBD -> tMOD + 4tCK 5. tCMD_GEAR Min. : TBD -> tMOD - Update DRAM DQs In Receive Mode table. - Update Command, Address, Control Setup and Hold Values table. - Command, Address, Control Input Voltage Values table.	26th Apr, 2018	Final	C.M.Kang J.Y.Bae

Table Of Contents

288pin ECC Unbuffered DIMM based on 8Gb B-die

1. DDR4 Unbuffered DIMM ORDERING INFORMATION	5
2. KEY FEATURES	5
3. ADDRESS CONFIGURATION	5
4. x72 DIMM Pin Configurations (Front side/Back side)	6
5. PIN DESCRIPTION	7
6. INPUT/OUTPUT FUNCTIONAL DESCRIPTION	8
6.1 Address Mirroring	10
7. FUNCTION BLOCK DIAGRAM:	11
7.1 8GB, 1Gx72 ECC Module (Populated as 1 rank of x8 DDR4 SDRAMs)	11
7.2 16GB, 2Gx72 ECC Module (Populated as 2 ranks of x8 DDR4 SDRAMs)	12
8. ABSOLUTE MAXIMUM RATINGS	13
9. AC & DC OPERATING CONDITIONS	13
10. AC & DC INPUT MEASUREMENT LEVELS	14
10.1 AC & DC Logic Input Levels for Single-Ended Signals	14
10.2 AC and DC Input Measurement Levels: VREF Tolerances	14
10.3 AC and DC Logic Input Levels for Differential Signals	15
10.3.1. Differential Signals Definition	15
10.3.2. Differential Swing Requirements for Clock (CK _t - CK _c)	15
10.3.3. Single-ended Requirements for Differential Signals	16
10.3.4. Address, Command and Control Overshoot and Undershoot specifications	17
10.3.5. Clock Overshoot and Undershoot Specifications	18
10.3.6. Data, Strobe and Mask Overshoot and Undershoot Specifications	19
10.4 Slew Rate Definitions	20
10.4.1. Slew Rate Definitions for Differential Input Signals (CK)	20
10.4.2. Slew Rate Definition for Single-ended Input Signals (CMD/ADD)	21
10.5 Differential Input Cross Point Voltage	22
10.6 CMOS rail to rail Input Levels	23
10.6.1. CMOS rail to rail Input Levels for RESET _n	23
10.7 AC and DC Logic Input Levels for DQS Signals	24
10.7.1. Differential signal definition	24
10.7.2. Differential swing requirements for DQS (DQS _t - DQS _c)	24
10.7.3. Peak voltage calculation method	25
10.7.4. Differential Input Cross Point Voltage	26
10.7.5. Differential Input Slew Rate Definition	27
11. AC AND DC OUTPUT MEASUREMENT LEVELS	28
11.1 Output Driver DC Electrical Characteristics	28
11.1.1. Alert _n output Drive Characteristic	30
11.1.2. Output Driver Characteristic of Connectivity Test (CT) Mode	31
11.2 Single-ended AC & DC Output Levels	32
11.3 Differential AC & DC Output Levels	32
11.4 Single-ended Output Slew Rate	33
11.5 Differential Output Slew Rate	34
11.6 Single-ended AC & DC Output Levels of Connectivity Test Mode	35
11.7 Test Load for Connectivity Test Mode Timing	36
12. SPEED BIN	37
12.1 Speed Bin Table Note	42
13. IDD AND IDDQ SPECIFICATION PARAMETERS AND TEST CONDITIONS	43
13.1 IDD, IPP and IDDQ Measurement Conditions	43
14. IDD SPEC TABLE	58
15. INPUT/OUTPUT CAPACITANCE	61
16. ELECTRICAL CHARACTERISTICS & AC TIMING	62
16.1 Reference Load for AC Timing and Output Slew Rate	62
16.2 tREFI	62
16.3 Clock Specification	63
16.3.1. Definition for tCK(abs)	63
16.3.2. Definition for tCK(avg)	63
16.3.3. Definition for tCH(avg) and tCL(avg)	63
16.3.4. Definition for tERR(nper)	63
17. TIMING PARAMETERS BY SPEED GRADE	64
17.1 Rounding Algorithms	70
17.2 The DQ input receiver compliance mask for voltage and timing	71
17.3 Command, Control, and Address Setup, Hold, and Derating	75
17.4 DDR4 Function Matrix	77
18. PHYSICAL DIMENSIONS	79
18.1 1Gx8 based 1Gx72 Module (1 Rank) - M391A1K43BB1	79
18.2 1Gx8 based 1Gx72 Module (1 Rank) - M391A1K43BB2	80
18.3 1Gx8 based 2Gx72 Module (2 Ranks) - M391A2K43BB1	81

1. DDR4 Unbuffered DIMM ORDERING INFORMATION

[Table 1] Ordering Information Table

Part Number ²⁾	Density	Organization	Component Composition ¹⁾	Number of Rank	Height
M391A1K43BB1-CPB/RC	8GB	1Gx72	1Gx8(K4A8G085WB-BCPB/RC)*9	1	31.25mm
M391A1K43BB2-CTD	8GB	1Gx72	1Gx8(K4A8G085WB-BCTD)*9	1	31.25mm
M391A2K43BB1-CPB/RC/TD	16GB	2Gx72	1Gx8(K4A8G085WB-BC##)*18	2	31.25mm

NOTE :

1) "##" -PB/RC/TD

2) PB(2133Mbps 15-15-15)/RC(2400Mbps 17-17-17)/TD(2666Mbps 19-19-19)

- DDR4-2666(19-19-19) is backward compatible to lower frequency.

2. KEY FEATURES

[Table 2] Speed Bins

Speed	DDR4-1600	DDR4-1866	DDR4-2133	DDR4-2400	DDR4-2666	Unit
	11-11-11	13-13-13	15-15-15	17-17-17	19-19-19	
tCK(min)	1.25	1.071	0.937	0.833	0.75	ns
CAS Latency	11	13	15	17	19	nCK
tRCD(min)	13.75	13.92	14.06	14.16	14.25	ns
tRP(min)	13.75	13.92	14.06	14.16	14.25	ns
tRAS(min)	35	34	33	32	32	ns
tRC(min)	48.75	47.92	47.06	46.16	46.25	ns

- JEDEC standard 1.2V ± 0.06V Power Supply
- V_{DDQ} = 1.2V ± 0.06V
- 800 MHz f_{CK} for 1600Mb/sec/pin, 933 MHz f_{CK} for 1866Mb/sec/pin, 1067MHz f_{CK} for 2133Mb/sec/pin, 1200MHz f_{CK} for 2400Mb/sec/pin, 1333MHz f_{CK} for 2666Mb/sec/pin
- 16 Banks (4 Bank Groups)
- Programmable CAS Latency: 10,11,12,13,14,15,16,17,18,19,20
- Programmable Additive Latency (Posted CAS): 0, CL - 2, or CL - 1 clock
- Programmable CAS Write Latency (CWL) = 9,11 (DDR4-1600), 10,12 (DDR4-1866), 11,14 (DDR4-2133), 12,16 (DDR4-2400) and 14,18 (DDR4-2666)
- Burst Length: 8, 4 with tCCD = 4 which does not allow seamless read or write [either On the fly using A12 or MRS]
- Bi-directional Differential Data Strobe
- On Die Termination using ODT pin
- Average Refresh Period 7.8us at lower than T_{CASE} 85°C, 3.9us at 85°C < T_{CASE} ≤ 95°C
- Asynchronous Reset

3. ADDRESS CONFIGURATION

Organization	Row Address	Column Address	Bank Group Address	Bank Address	Auto Precharge
512Mx16(8Gb) based Module	A0-A15	A0-A9	BG0	BA0-BA1	A10/AP
1Gx8(8Gb) based Module	A0-A15	A0-A9	BG0-BG1	BA0-BA1	A10/AP

4. x72 DIMM Pin Configurations (Front side/Back side)

Pin	Front	Pin	Back	Pin	Front	Pin	Back	Pin	Front	Pin	Back	Pin	Front	Pin	Back
1	1.2V,NC	145	1.2V,NC	39	VSS	183	DQ25	77	VTT	221	VTT	114	VSS	258	DQ47
2	VSS	146	VREFCA	40	TDQS12_t,DQ S12_t,DM3_n, DBI3_n,NC	184	VSS	KEY				115	DQ42	259	VSS
3	DQ4	147	VSS	41	TDQS12_c,D QS12_c,NC	185	DQS3_c	78	EVENT_n	222	PARITY	116	VSS	260	DQ43
4	VSS	148	DQ5	42	VSS	186	DQS3_t	79	A0	223	VDD	117	DQ52	261	VSS
5	DQ0	149	VSS	43	DQ30	187	VSS	80	VDD	224	BA1	118	VSS	262	DQ53
6	VSS	150	DQ1	44	VSS	188	DQ31	81	BA0	225	A10/AP	119	DQ48	263	VSS
7	TDQS9_t,DQS 9_t,DM0_n,DB IO_n,NC	151	VSS	45	DQ26	189	VSS	82	RAS_n/A16	226	VDD	120	VSS	264	DQ49
8	TDQS9_c,DQ S9_c,NC	152	DQS0_c	46	VSS	190	DQ27	83	VDD	227	RFU	121	TDQS15_t,DQ S15_t,DM6_n, DBI6_n,NC	265	VSS
9	VSS	153	DQS0_t	47	CB4,NC	191	VSS	84	CS0_n	228	WE_n/A14	122	TDQS15_c,D QS15_c,NC	266	DQS6_c
10	DQ6	154	VSS	48	VSS	192	CB5,NC	85	VDD	229	VDD	123	VSS	267	DQS6_t
11	VSS	155	DQ7	49	CB0,NC	193	VSS	86	CAS_n/A15	230	NC,SAVE_n	124	DQ54	268	VSS
12	DQ2	156	VSS	50	VSS	194	CB1,NC	87	ODT0	231	VDD	125	VSS	269	DQ55
13	VSS	157	DQ3	51	TDQS17_t,DQ S17_t,DM8_n, DBI8_n,NC	195	VSS	88	VDD	232	A13	126	DQ50	270	VSS
14	DQ12	158	VSS	52	TDQS17_c,D QS17_c,NC	196	DQS8_c	89	CS1_n	233	VDD	127	VSS	271	DQ51
15	VSS	159	DQ13	53	VSS	197	DQS8_t	90	VDD	234	NC,A17	128	DQ60	272	VSS
16	DQ8	160	VSS	54	CB6,NC	198	VSS	91	ODT1	235	NC,C2	129	VSS	273	DQ61
17	VSS	161	DQ9	55	VSS	199	CB7,NC	92	VDD	236	VDD	130	DQ56	274	VSS
18	TDQS10_t,DQ S10_t,DM1_n, DBI1_n,NC	162	VSS	56	CB2,NC	200	VSS	93	C0,CS2_n,NC	237	NC,CS3_n,C1	131	VSS	275	DQ57
19	TDQS10_c,DQ S10_c,NC	163	DQS1_c	57	VSS	201	CB3,NC	94	VSS	238	SA2	132	TDQS16_t,DQ S16_t,DM7_n, DBI7_n,NC	276	VSS
20	VSS	164	DQS1_t	58	RESET_n	202	VSS	95	DQ36	239	VSS	133	TDQS16_c,D QS16_c,NC	277	DQS7_c
21	DQ14	165	VSS	59	VDD	203	CKE1	96	VSS	240	DQ37	134	VSS	278	DQS7_t
22	VSS	166	DQ15	60	CKE0	204	VDD	97	DQ32	241	VSS	135	DQ62	279	VSS
23	DQ10	167	VSS	61	VDD	205	RFU	98	VSS	242	DQ33	136	VSS	280	DQ63
24	VSS	168	DQ11	62	ACT_n	206	VDD	99	TDQS13_t,DQ S13_t,DM4_n, DBI4_n,NC	243	VSS	137	DQ58	281	VSS
25	DQ20	169	VSS	63	BG0	207	BG1	100	TDQS13_c,D QS13_c,NC	244	DQS4_c	138	VSS	282	DQ59
26	VSS	170	DQ21	64	VDD	208	ALERT_n	101	VSS	245	DQS4_t	139	SA0	283	VSS
27	DQ16	171	VSS	65	A12/BC_n	209	VDD	102	DQ38	246	VSS	140	SA1	284	VDDSPD
28	VSS	172	DQ17	66	A9	210	A11	103	VSS	247	DQ39	141	SCL	285	SDA
29	TDQS11_t,DQ S11_t,DM2_n, DBI2_n,NC	173	VSS	67	VDD	211	A7	104	DQ34	248	VSS	142	VPP	286	VPP
30	TDQS11_c,DQ S11_c,NC	174	DQS2_c	68	A8	212	VDD	105	VSS	249	DQ35	143	VPP	287	VPP
31	VSS	175	DQS2_t	69	A6	213	A5	106	DQ44	250	VSS	144	RFU	288	VPP
32	DQ22	176	VSS	70	VDD	214	A4	107	VSS	251	DQ45	NOTE : 1) Light colored text indicates functions that are not applicable for UDIMM wiring. An example is the A17 for pin 234 because UDIMMs defined by this specification will never have DIMM wiring for this pin.			
33	VSS	177	DQ23	71	A3	215	VDD	108	DQ40	252	VSS				
34	DQ18	178	VSS	72	A1	216	A2	109	VSS	253	DQ41				
35	VSS	179	DQ19	73	VDD	217	VDD	110	TDQS14_t,DQ S14_t,DM5_n, DBI5_n,NC	254	VSS				
36	DQ28	180	VSS	74	CK0_t	218	CK1_t	111	TDQS14_c,D QS14_c,NC	255	DQS5_c				
37	VSS	181	DQ29	75	CK0_c	219	CK1_c	112	VSS	256	DQS5_t				
38	DQ24	182	VSS	76	VDD	220	VDD	113	DQ46	257	VSS				

5. PIN DESCRIPTION

Pin Name	Description
A0–A17 ¹⁾	SDRAM address bus
BA0, BA1	SDRAM bank select
BG0, BG1	SDRAM bank group select
RAS_n ²⁾	SDRAM row address strobe
CAS_n ³⁾	SDRAM column address strobe
WE_n ⁴⁾	SDRAM write enable
CS0_n, CS1_n	DIMM Rank Select Lines
CKE0, CKE1	SDRAM clock enable lines
ODT0, ODT1	SDRAM on-die termination control lines
ACT_n	SDRAM activate
DQ0–DQ63	DIMM memory data bus
CB0–CB7	DIMM ECC check bits
TDQS0_t–TDQS8_t TDQS0_c–TDQS8_c	Dummy loads for mixed populations of x4 based and x8 based RDIMMs. Not used on UDIMMs.
DQS0_t–DQS8_t	SDRAM data strobes (positive line of differential pair)
DQS0_c–DQS8_c	SDRAM data strobes (negative line of differential pair)
DM0_n–DM8_n, DBI0_n–DBI8_n	SDRAM data masks/data bus inversion (x8-based x64 DIMMs)
CK0_t, CK1_t	SDRAM clocks (positive line of differential pair)
CK0_c, CK1_c	SDRAM clocks (negative line of differential pair)

Pin Name	Description
SCL	I ² C serial bus clock for SPD-TSE
SDA	I ² C serial bus data line for SPD-TSE
SA0–SA2	I ² C slave address select for SPD-TSE
PARITY	SDRAM parity input
VDD	SDRAM I/O and core power supply
12 V	Optional power Supply on socket but not used on UDIMM
VREFCA	
VSS	Power supply return (ground)
VDDSPD	Serial SPD-TSE positive power supply
ALERT_n	SDRAM ALERT_n
VPP	SDRAM Supply
RESET_n	Set DRAMs to a Known State
EVENT_n	SPD signals a thermal event has occurred
VTT	SDRAM I/O termination supply
RFU	Reserved for future use

NOTE :

- 1) Address A17 is not valid for x8 and x16 based SDRAMs. For UDIMMs this connection pin is NC.
- 2) RAS_n is a multiplexed function with A16.
- 3) CAS_n is a multiplexed function with A15.
- 4) WE_n is a multiplexed function with A14.

[Table 3] Temperature Sensor Characteristics

Grade	Range	Temperature Sensor Accuracy			Units	NOTE
		Min.	Typ.	Max.		
B	75 < Ta < 95	-	+/- 0.5	+/- 1.0	°C	-
	40 < Ta < 125	-	+/- 1.0	+/- 2.0		-
	-20 < Ta < 125	-	+/- 2.0	+/- 3.0		-
Resolution		0.25			°C /LSB	-

6. INPUT/OUTPUT FUNCTIONAL DESCRIPTION

Symbol	Type	Function
CK_t, CK_c	Input	Clock: CK_t and CK_c are differential clock inputs. All address and control input signals are sampled on the crossing of the positive edge of CK_t and negative edge of CK_c.
CKE, (CKE1)	Input	Clock Enable: CKE HIGH activates and CKE LOW deactivates internal clock signals and device input buffers and output drivers. Taking CKE LOW provides Precharge Power-Down and Self-Refresh operation (all banks idle), or Active Power-Down (row Active in any bank). CKE is synchronous for Self-Refresh exit. After VREFCA and Internal DQ Vref have become stable during the power on and initialization sequence, they must be maintained during all operations (including Self-Refresh). CKE must be maintained high throughout read and write accesses. Input buffers, excluding CK_t, CK_c, ODT and CKE, are disabled during power-down. Input buffers, excluding CKE, are disabled during Self-Refresh.
CS_n (CS1_n)	Input	Chip Select: All commands are masked when CS_n is registered HIGH. CS_n provides for external Rank selection on systems with multiple Ranks. CS_n is considered part of the command code. CS2_n and CS3_n are not used on UDIMMs
C0, C1, C2	Input	Chip ID: Chip ID is only used for 3DS for 2,4,8 high stack via TSV to select each slice of stacked component. Chip ID is considered part of the command code. Not used on UDIMMs.
ODT (ODT1)	Input	On Die Termination: ODT (registered HIGH) enables RTT_NOM termination resistance internal to the DDR4 SDRAM. When enabled, ODT is only applied to each DQ, DQS_t, DQS_c and DM_n/DBI_n/TDQS_t, NU/TDQS_c (When TDQS is enabled via Mode Register A11=1 in MR1) signal for x8 configurations. For x16 configuration ODT is applied to each DQ, DQSU_t, DQSU_c, DQSL_t, DQSL_c, DMU_n, and DML_n signal. The ODT pin will be ignored if MR1 is programmed to disable RTT_NOM.
ACT_n	Input	Activation Command Input: ACT_n defines the Activation command being entered along with CS_n. The input into RAS_n/A16, CAS_n/A15 and WE_n/A14 will be considered as Row Address A16, A15 and A14.
RAS_n/A16, CAS_n/A15, WE_n/A14	Input	Command Inputs: RAS_n/A16, CAS_n/A15 and WE_n/A14 (along with CS_n) define the command being entered. Those pins have multi function. For example, for activation with ACT_n Low, these are Addresses like A16, A15 and A14 but for non-activation command with ACT_n High, these are Command pins for Read, Write and other command defined in command truth table.
DM_n/DBI_n/ TDQS_t, (DMU_n/ DBIU_n), (DML_n/ DBIL_n)	Input/ Output	Input Data Mask and Data Bus Inversion: DM_n is an input mask signal for write data. Input data is masked when DM_n is sampled LOW coincident with that input data during a Write access. DBI_n is an input/output identifying whether to store/output the true or inverted data. If DBI_n is LOW, the data will be stored/output after inversion inside the DDR4 SDRAM and not inverted if DBI_n is HIGH. TDQS is only supported in x8 SDRAM configurations. TDQS is not valid for UDIMMs.
BG0 - BG1	Input	Bank Group Inputs: BG0 - BG1 define which bank group an Active, Read, Write or Precharge command is being applied. BG0 also determines which mode register is to be accessed during a MRS cycle. x4/x8 SDRAM configurations have BG0 and BG1. x16 based SDRAMs only have BG0.
BA0 - BA1	Input	Bank Address Inputs: BA0 - BA1 define to which bank an Active, Read, Write or Precharge command is being applied. Bank address also determines which mode register is to be accessed during a MRS cycle.
A0 - A17	Input	Address Inputs: Provide the row address for ACTIVATE Commands and the column address for Read/Write commands to select one location out of the memory array in the respective bank. A10/AP, A12/BC_n, RAS_n/A16, CAS_n/A15 and WE_n/A14 have additional functions. See other rows. The address inputs also provide the op-code during Mode Register Set commands. A17 is only defined for the x4 SDRAM configuration.
A10 / AP	Input	Auto-precharge: A10 is sampled during Read/Write commands to determine whether Autoprecharge should be performed to the accessed bank after the Read/Write operation. (HIGH: Autoprecharge; LOW: no Autoprecharge). A10 is sampled during a Precharge command to determine whether the Precharge applies to one bank (A10 LOW) or all banks (A10 HIGH). If only one bank is to be precharged, the bank is selected by bank addresses.
A12 / BC_n	Input	Burst Chop: A12/BC_n is sampled during Read and Write commands to determine if burst chop (on-the-fly) will be performed. (HIGH, no burst chop; LOW: burst chopped). See command truth table for details.
RESET_n	CMOS Input	Active Low Asynchronous Reset: Reset is active when RESET_n is LOW, and inactive when RESET_n is HIGH. RESET_n must be HIGH during normal operation.
DQ	Input/ Output	Data Input/ Output: Bi-directional data bus. If CRC is enabled via Mode register then CRC code is added at the end of Data Burst. Any DQ from DQ0-DQ3 may indicate the internal Vref level during test via Mode Register Setting MR4 A4=High. Refer to vendor specific data sheets to determine which DQ is used.
DQS_t, DQS_c, DQSU_t, DQSU_c, DQSL_t, DQSL_c	Input/ Output	Data Strobe: output with read data, input with write data. Edge-aligned with read data, centered in write data. For the x16, DQSL corresponds to the data on DQL0-DQL7; DQSU corresponds to the data on DQU0-DQU7. The data strobe DQS_t, DQSL_t and DQSU_t are paired with differential signals DQS_c, DQSL_c, and DQSU_c, respectively, to provide differential pair signaling to the system during reads and writes. DDR4 SDRAM supports differential data strobe only and does not support single-ended.

Symbol	Type	Function
TDQS_t, TDQS_c	Output	Termination Data Strobe: TDQS_t/TDQS_c are not valid for UDIMMs.
PAR	Input	Command and Address Parity Input: DDR4 Supports Even Parity check in DRAMs with MR setting. Once it's enabled via Register in MR5, then DRAM calculates Parity with ACT_n, RAS_n/A16, CAS_n/A15, WE_n/A14, BG0-BG1, BA0-BA1, A16-A0. LOW Command and address inputs shall have parity check performed when commands are latched via the rising edge of CK_t and when CS_n is low.
ALERT_n	Output	Alert: It has multi functions such as CRC error flag, Command and Address Parity error flag as Output signal. If there is error in CRC, then ALERT_n goes LOW for the period time interval and goes back HIGH. If there is error in Command Address Parity Check, then ALERT_n goes LOW for relatively long period until on going DRAM internal recovery transaction is complete. During Connectivity Test mode this pin functions as an input. Using this signal or not is dependent on the system.
TEN	Input	Connectivity Test Mode Enable : Required on X16 devices and optional input on x4/x8 with densities equal to or greater than 8Gb.HIGH in this pin will enable Connectivity Test Mode operation along with other pins. It is a CMOS rail to rail signal with AC high and low at 80% and 20% of VDD. Using this signal or not is dependent on System. This pin may be DRAM internally pulled low through a weak pull-down resistor to VSS
NC		No Connect: No on DIMM electrical connection is present.
VDDQ	Supply	DQ Power Supply: 1.2 V +/- 0.06 V
VSSQ	Supply	DQ Ground
VDD	Supply	Power Supply: 1.2 V +/- 0.06 V
VSS	Supply	Ground
VPP	Supply	DRAM Activating Power Supply: 2.5V (2.375V min, 2.75V max)
12 V	Supply	12 V supply not used on UDIMMs.
VDDSPD	Supply	Power supply used to power the I2C bus on the SPD-TSE 2.5V or 3.3V.
VREFCA	Supply	Reference voltage for CA
ZQ	Supply	Reference Pin for ZQ calibration

NOTE :

1) Input only pins (BG0-BG1,BA0-BA1, A0-A17, ACT_n, RAS_n/A16, CAS_n/A15, WE_n/A14, CS_n, CKE, ODT, and RESET_n) do not supply termination.

6.1 Address Mirroring

DDR4 two rank UDIMMs will use address mirroring. DRAMs for even ranks will be placed on the front side of the module. DRAMs for odd ranks will be placed on the back side of the module. Wiring of the address bus will be as defined in Table 4.

Since the cross-wired pins have no secondary functions, there is no problem in normal operation. Any data written is read the same way. There are limitations however. When writing to the internal registers with a "load mode" operation, the specific address is required. This requires the controller to know if the rank is mirrored or not. There is a bit assignment in the SPD that indicates whether the module has been designed with the mirrored feature or not. See the DDR4 SPD specification for these details. The controller must read the SPD and have the capability of de-mirroring the address when accessing the odd ranks.

[Table 4] DIMM Wiring Definition for Address Mirroring

Signal Name	DRAM Ball Label		Comment
	Even Rank	Odd Rank	
A0	A0	A0	
A1	A1	A1	
A2	A2	A2	
A3	A3	A4	
A4	A4	A3	
A5	A5	A6	
A6	A6	A5	
A7	A7	A8	
A8	A8	A7	
A9	A9	A9	
A10/AP	A10/AP	A10/AP	
A11	A11	A13	
A12/BC_n	A12/BC_n	A12/BC_n	
A13	A13	A11	
A14/WE_n	A14/WE_n	A14/WE_n	
A15/CAS_n	A15/CAS_n	A15/CAS_n	
A16/RAS_n	A16/RAS_n	A16/RAS_n	
A17	A17	A17	Not valid for x8 and x16 DRAM components up to 16Gb.
BA0	BA0	BA1	
BA1	BA1	BA0	
BG0	BG0	BG1	BG1 is not valid for x16 DRAM components. For x16 DRAM components signal BG0 will be wired to DRAM ball BG0 for both ranks.
BG1	BG1	BG0	BG1 is not valid for x16 DRAM components. For x16 DRAM components signal BG0 will be wired to DRAM ball BG0 for both ranks.

7. FUNCTION BLOCK DIAGRAM:

7.1 8GB, 1Gx72 ECC Module (Populated as 1 rank of x8 DDR4 SDRAMs)

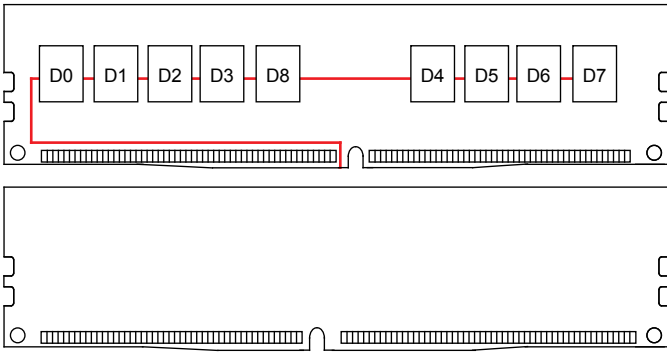
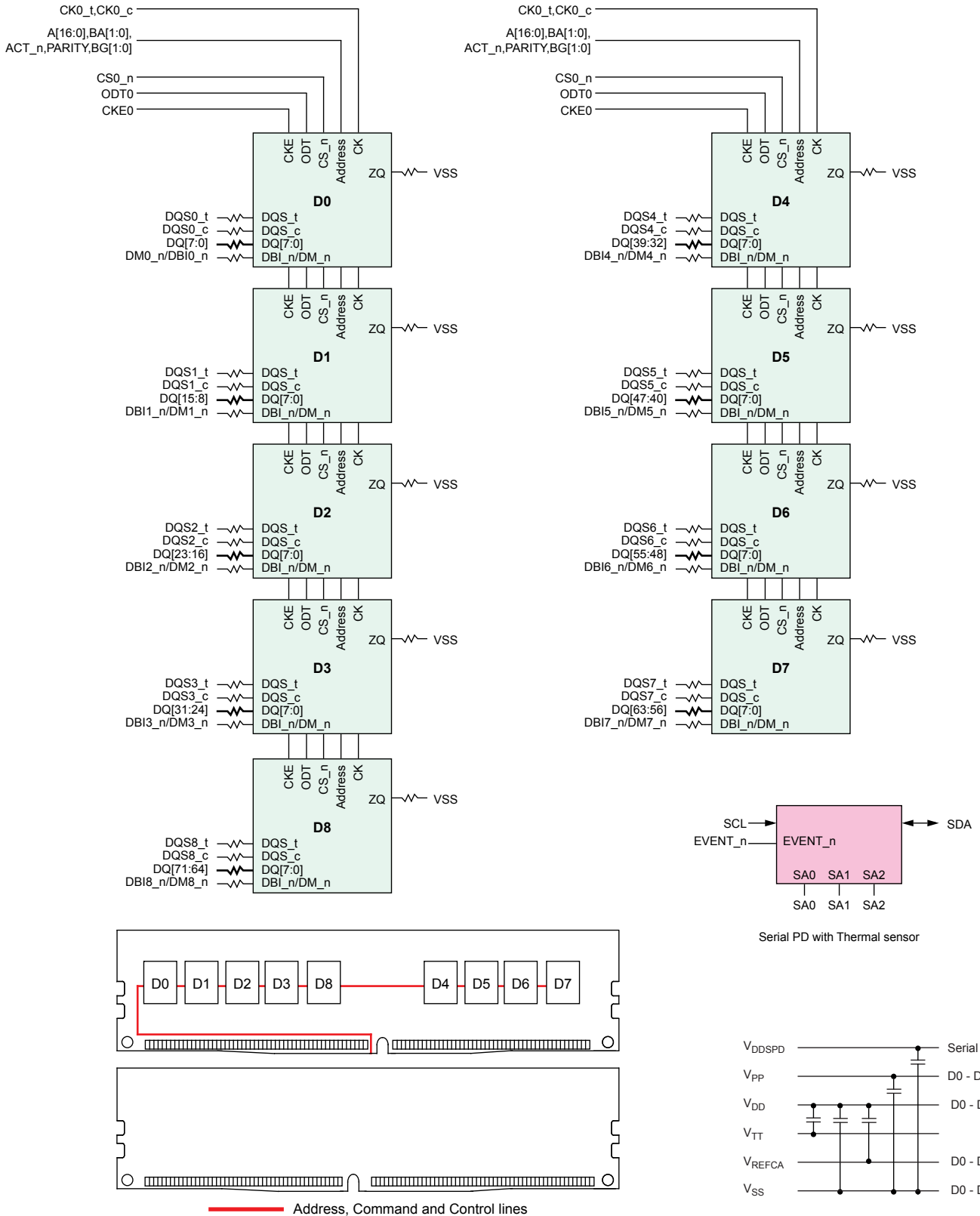

Address, Command and Control lines

NOTE :

- 1) Unless otherwise noted, resistor values are $15\Omega \pm 5\%$.
- 2) ZQ resistors are $240\Omega \pm 1\%$. For all other resistor values refer to the appropriate wiring diagram.
- 3) For part 2 of 2 the DQ resistors are shown for simplicity but are the same physical components as shown on part 1 of 2.
- 4) EVENT_n is used for SPD with TS. Option Resistor for it should be placed.

7.2 16GB, 2Gx72 ECC Module (Populated as 2 ranks of x8 DDR4 SDRAMs)

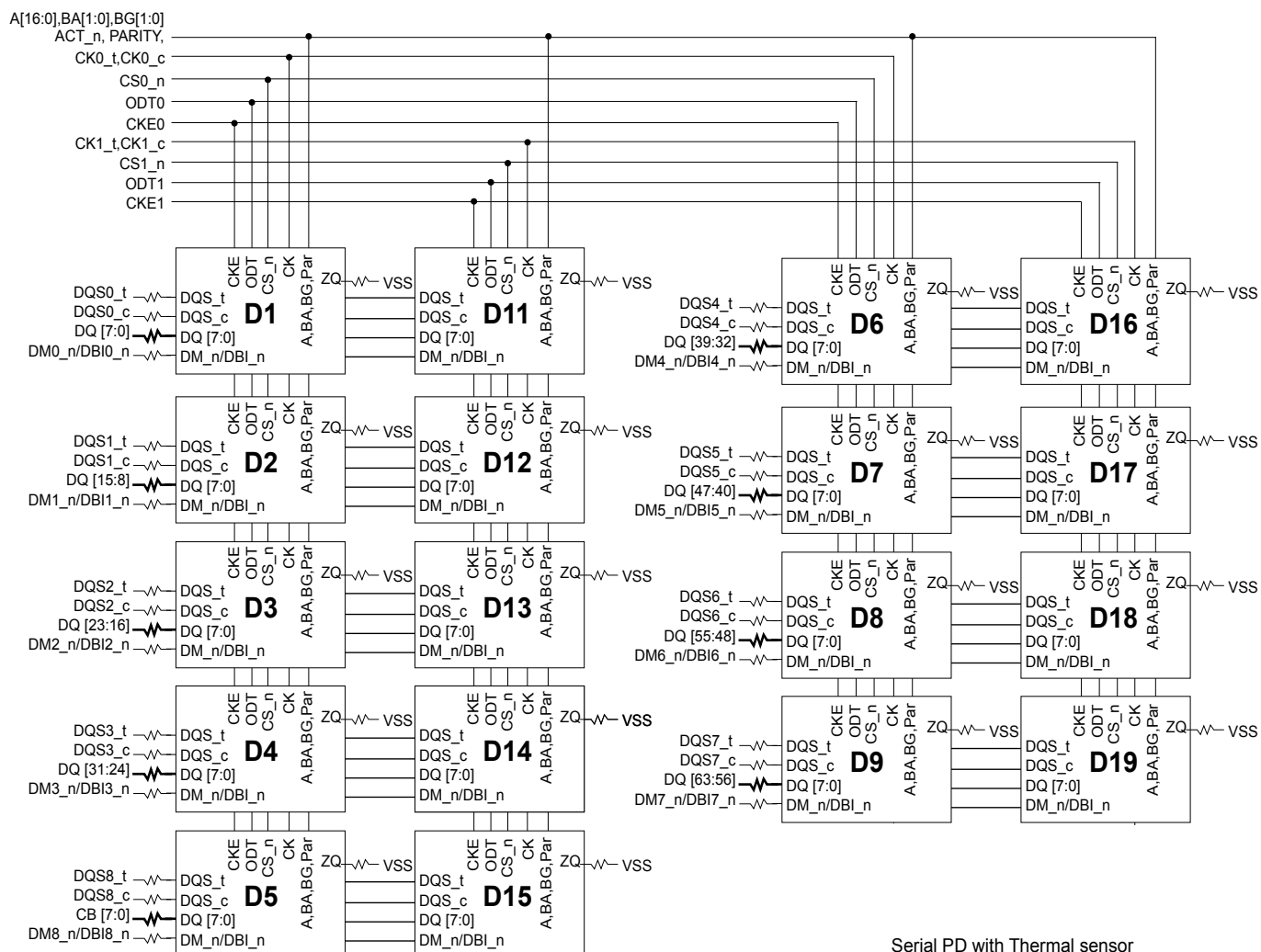

Serial PD with Thermal sensor

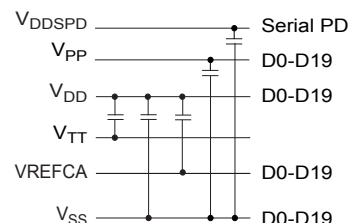
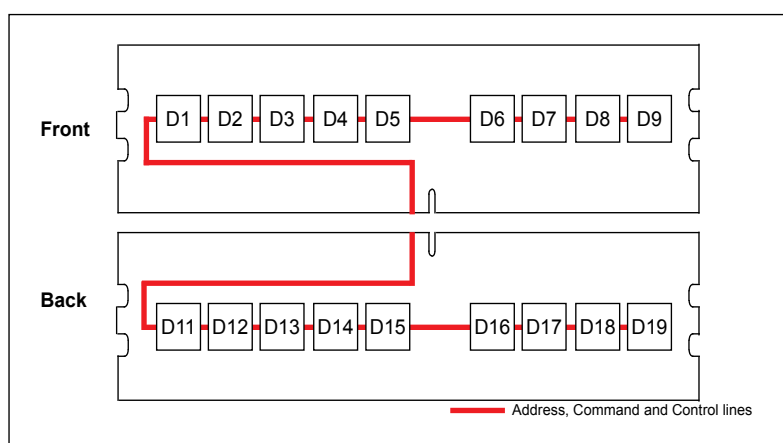
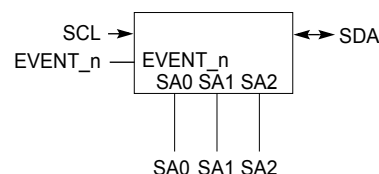

NOTE :
 1) Unless otherwise noted, resistor values are $15\Omega \pm 5\%$.
 2) ZQ resistors are $240\Omega \pm 1\%$. For all other resistor values refer to the appropriate wiring diagram.

8. ABSOLUTE MAXIMUM RATINGS

[Table 5] Absolute Maximum DC Ratings

Symbol	Parameter	Rating	Units	NOTE
VDD	Voltage on VDD pin relative to Vss	-0.3 ~ 1.5	V	1,3
VDDQ	Voltage on VDDQ pin relative to Vss	-0.3 ~ 1.5	V	1,3
VPP	Voltage on VPP pin relative to Vss	-0.3 ~ 3.0	V	4
V _{IN} , V _{OUT}	Voltage on any pin except VREFCA relative to Vss	-0.3 ~ 1.5	V	1,3,5
T _{STG}	Storage Temperature	-55 to +100	°C	1,2

NOTE :

- 1) Stresses greater than those listed under "Absolute Maximum Ratings" may cause permanent damage to the device. This is a stress rating only and functional operation of the device at these or any other conditions above those indicated in the operational sections of this specification is not implied. Exposure to absolute maximum rating conditions for extended periods may affect reliability
- 2) Storage Temperature is the case surface temperature on the center/top side of the DRAM. For the measurement conditions, please refer to JEDEC51-2 standard.
- 3) VDD and VDDQ must be within 300mV of each other at all times; and VREFCA must be not greater than 0.6 x VDDQ, When VDD and VDDQ are less than 500mV; VREFCA may be equal to or less than 300mV
- 4) VPP must be equal or greater than VDD/VDDQ at all times.
- 5) Overshoot area above 1.5 V is specified in 10.3.4, 10.3.5 and 10.3.6.

9. AC & DC OPERATING CONDITIONS

[Table 6] Recommended DC Operating Conditions

Symbol	Parameter	Rating			Unit	NOTE
		Min.	Typ.	Max.		
VDD	Supply Voltage	1.14	1.2	1.26	V	1,2,3
VDDQ	Supply Voltage for Output	1.14	1.2	1.26	V	1,2,3
VPP	Peak-to-Peak Voltage	2.375	2.5	2.75	V	3

NOTE :

- 1) Under all conditions V_{DDQ} must be less than or equal to V_{DD}.
- 2) V_{DDQ} tracks with V_{DD}. AC parameters are measured with V_{DD} and V_{DDQ} tied together.
- 3) DC bandwidth is limited to 20MHz.

10. AC & DC INPUT MEASUREMENT LEVELS

10.1 AC & DC Logic Input Levels for Single-Ended Signals

[Table 7] Single-ended AC & DC Input Levels for Command and Address

Symbol	Parameter	DDR4-1600/1866/2133/2400		DDR4-2666		Unit	NOTE
		Min.	Max.	Min.	Max.		
VIH.CA(DC75)	DC input logic high	$V_{REFCA} + 0.075$	VDD	-	-	V	
VIH.CA(DC65)		-	-	$V_{REFCA} + 0.065$	VDD		
VIL.CA(DC75)	DC input logic low	VSS	$V_{REFCA} - 0.075$	-	-	V	
VIL.CA(DC65)		-	-	VSS	$V_{REFCA} - 0.065$		
VIH.CA(AC100)	AC input logic high	$V_{REF} + 0.1$	Note 2	-	-	V	1
VIH.CA(AC90)		-	-	$V_{REF} + 0.09$	Note 2		
VIL.CA(AC100)	AC input logic low	Note 2	$V_{REF} - 0.1$	-	-	V	1
VIL.CA(AC90)		-	-	Note 2	$V_{REF} - 0.09$		
VREFCA(DC)	Reference Voltage for ADD, CMD inputs	$0.49 \cdot VDD$	$0.51 \cdot VDD$	$0.49 \cdot VDD$	$0.51 \cdot VDD$	V	2,3

NOTE :

- 1) See "Overshoot and Undershoot Specifications" on section 10.3.
- 2) The AC peak noise on VREFCA may not allow VREFCA to deviate from VREFCA(DC) by more than $\pm 1\%$ VDD (for reference : approx. $\pm 12mV$)
- 3) For reference : approx. $VDD/2 \pm 12mV$.

10.2 AC and DC Input Measurement Levels: V_{REF} Tolerances.

The DC-tolerance limits and ac-noise limits for the reference voltages V_{REFCA} is illustrated in Figure 1. It shows a valid reference voltage $V_{REF}(t)$ as a function of time. (V_{REF} stands for V_{REFCA}).

$V_{REF}(DC)$ is the linear average of $V_{REF}(t)$ over a very long period of time (e.g. 1 sec). This average has to meet the min/max requirement in Table 7. Furthermore $V_{REF}(t)$ may temporarily deviate from $V_{REF}(DC)$ by no more than $\pm 1\%$ V_{DD} .

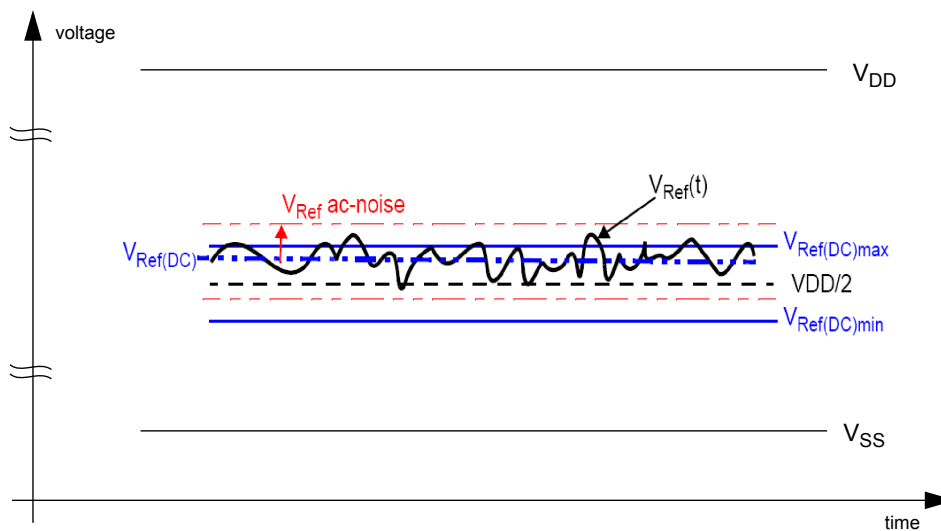

Figure 1. Illustration of $V_{REF}(DC)$ tolerance and V_{REF} AC-noise limits

The voltage levels for setup and hold time measurements $V_{IH}(AC)$, $V_{IH}(DC)$, $V_{IL}(AC)$ and $V_{IL}(DC)$ are dependent on V_{REF} .

" V_{REF} " shall be understood as $V_{REF}(DC)$, as defined in Figure 1.

This clarifies, that DC-variations of V_{REF} affect the absolute voltage a signal has to reach to achieve a valid high or low level and therefore the time to which setup and hold is measured. System timing and voltage budgets need to account for $V_{REF}(DC)$ deviations from the optimum position within the data-eye of the input signals.

This also clarifies that the DRAM setup/hold specification and derating values need to include time and voltage associated with V_{REF} AC-noise. Timing and voltage effects due to AC-noise on V_{REF} up to the specified limit ($\pm 1\%$ of V_{DD}) are included in DRAM timings and their associated deratings.

10.3 AC and DC Logic Input Levels for Differential Signals

10.3.1 Differential Signals Definition

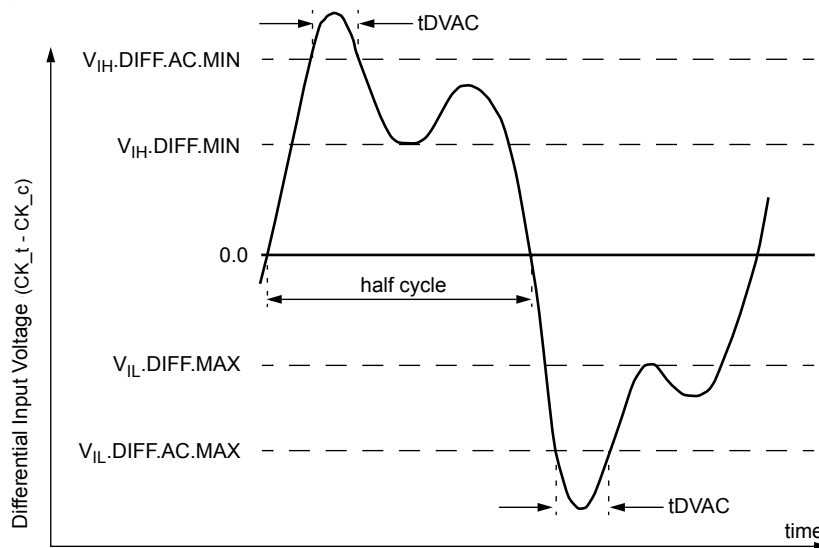

Figure 2. Definition of differential ac-swing and “time above ac-level” tDVAC

NOTE:

- 1) Differential signal rising edge from V_{IL.DIFF.MAX} to V_{IH.DIFF.MIN} must be monotonic slope.
- 2) Differential signal falling edge from V_{IH.DIFF.MIN} to V_{IL.DIFF.MAX} must be monotonic slope.

10.3.2 Differential Swing Requirements for Clock (CK_t - CK_c)

[Table 8] Differential AC and DC Input Levels

Symbol	Parameter	DDR4 -1600/1866/2133		DDR4 -2400/2666		unit	NOTE
		min	max	min	max		
V _{IHdiff}	differential input high	+0.150	NOTE 3	0.135	NOTE 3	V	1
V _{ILdiff}	differential input low	NOTE 3	-0.150	NOTE 3	-0.135	V	1
V _{IHdiff(AC)}	differential input high ac	2 x (V _{IH(AC)} - V _{REF})	NOTE 3	2 x (V _{IH(AC)} - V _{REF})	NOTE 3	V	2
V _{ILdiff(AC)}	differential input low ac	NOTE 3	2 x (V _{IL(AC)} - V _{REF})	NOTE 3	2 x (V _{IL(AC)} - V _{REF})	V	2

NOTE :

- 1) Used to define a differential signal slew-rate.
- 2) for CK_t - CK_c use V_{IH,CA}/V_{IL,CA(AC)} of ADD/CMD and V_{REFCA};
- 3) These values are not defined; however, the differential signals CK_t - CK_c, need to be within the respective limits (V_{IH,CA(DC)} max, V_{IL,CA(DC)}min) for single-ended signals as well as the limitations for overshoot and undershoot.

[Table 9] Allowed Time Before Ringback (tDVAC) for CK_t - CK_c

Slew Rate [V/ns]	tDVAC [ps] @ V _{IH/Ldiff(AC)} = 200mV	
	min	max
> 4.0	120	-
4.0	115	-
3.0	110	-
2.0	105	-
1.8	100	-
1.6	95	-
1.4	90	-
1.2	85	-
1.0	80	-
< 1.0	80	-

10.3.3 Single-ended Requirements for Differential Signals

Each individual component of a differential signal (CK_t, CK_c) has also to comply with certain requirements for single-ended signals.

CK_t and CK_c have to approximately reach V_{SEH}min / V_{SEL}max (approximately equal to the ac-levels (V_{IH}.CA(AC) / V_{IL}.CA(AC)) for ADD/CMD signals) in every half-cycle.

Note that the applicable ac-levels for ADD/CMD might be different per speed-bin etc. E.g., if Different value than V_{IH}.CA(AC100)/V_{IL}.CA(AC100) is used for ADD/CMD signals, then these ac-levels apply also for the single-ended signals CK_t and CK_c.

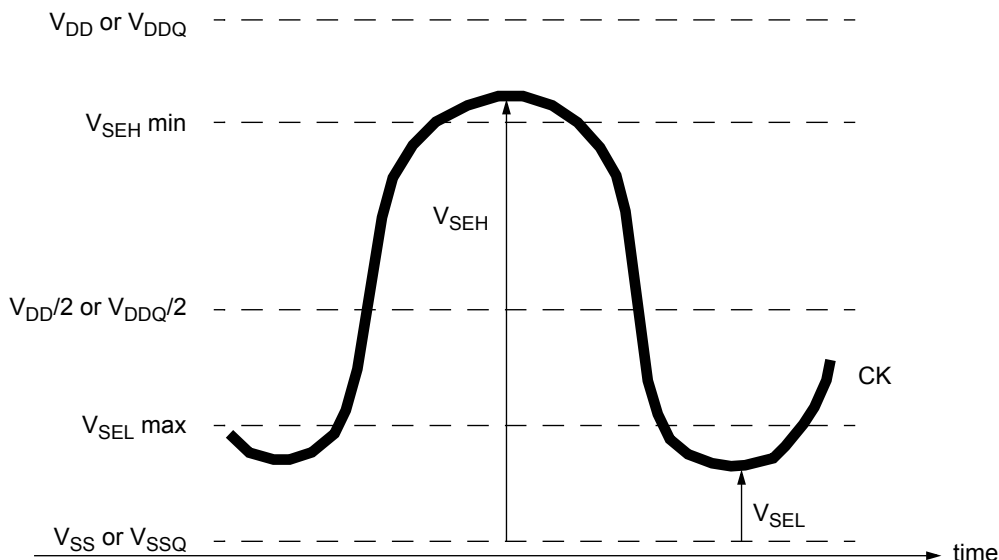

Figure 3. Single-ended requirement for differential signals.

Note that, while ADD/CMD signal requirements are with respect to V_{ref}CA, the single-ended components of differential signals have a requirement with respect to VDD / 2; this is nominally the same. The transition of single-ended signals through the ac-levels is used to measure setup time. For single-ended components of differential signals the requirement to reach V_{SEL}max, V_{SEH}min has no bearing on timing, but adds a restriction on the common mode characteristics of these signals.

[Table 10] Single-ended Levels for CK_t, CK_c

Symbol	Parameter	DDR4-1600/1866/2133		DDR4-2400/2666		Unit	NOTE
		Min	Max	Min	Max		
V _{SEH}	Single-ended high-level for CK _t , CK _c	(VDD/2)+0.100	NOTE3	(VDD/2)+0.95	NOTE3	V	1, 2
V _{SEL}	Single-ended low-level for CK _t , CK _c	NOTE3	(VDD/2)-0.100	NOTE3	(VDD/2)-0.95	V	1, 2

- NOTE :
- 1) For CK_t - CK_c use V_{IH}.CA/V_{IL}.CA(AC) of ADD/CMD;
 - 2) V_{IH}(AC)/V_{IL}(AC) for ADD/CMD is based on V_{REF}CA;
 - 3) These values are not defined, however the single-ended signals CK_t - CK_c need to be within the respective limits (V_{IH}.CA(DC) max, V_{IL}.CA(DC)min) for single-ended signals as well as the limitations for overshoot and undershoot.

10.3.4 Address, Command and Control Overshoot and Undershoot specifications

[Table 11] AC overshoot/undershoot specification for Address, Command and Control pins

Parameter	Symbol	Specification					Unit	NOTE	
		DDR4-1600	DDR4-1866	DDR4-2133	DDR4-2400	DDR4-2666			
Maximum peak amplitude above VAOS	VAOSP	0.06					TBD	V	
Upper boundary of overshoot area AAOS1	VAOS	VDD +0.24					TBD	V	1
Maximum peak amplitude allowed for undershoot	VAUS	0.30					TBD	V	
Maximum overshoot area per 1 tCK above VAOS	AAOS2	0.0083	0.0071	0.0062	0.0055	TBD	V-ns		
Maximum overshoot area per 1 tCK between VDD and VAOS	AAOS1	0.2550	0.2185	0.1914	0.1699	TBD	V-ns		
Maximum undershoot area per 1 tCK below VSS	AAUS	0.2644	0.2265	0.1984	0.1762	TBD	V-ns		
(A0-A13,A17,BG0-BG1,BA0-BA1,ACT_n,RAS_n/A16,CAS_n/A15,WE_n/A14,CS_n,CKE,ODT,C2-C0)									

NOTE :
 1) The value of VAOS matches VDD absolute max as defined in Table 5 Absolute Maximum DC Ratings if VDD equals VDD max as defined in Table 6 Recommended DC Operating Conditions. If VDD is above the recommended operating conditions, VAOS remains at VDD absolute max as defined in Table 5.

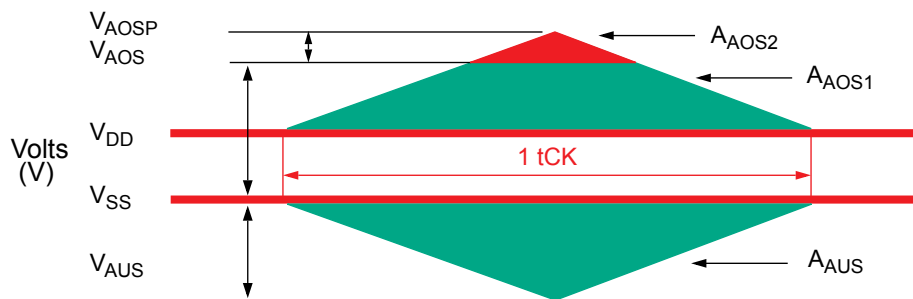

Figure 4. Address, Command and Control Overshoot and Undershoot Definition

10.3.5 Clock Overshoot and Undershoot Specifications

[Table 12] AC overshoot/undershoot specification for Clock

Parameter	Symbol	Specification					Unit	NOTE	
		DDR4-1600	DDR4-1866	DDR4-2133	DDR4-2400	DDR4-2666			
Maximum peak amplitude above VCOS	VCOSP	0.06					TBD	V	
Upper boundary of overshoot area ADOS1	VCOS	VDD +0.24					TBD	V	1
Maximum peak amplitude allowed for undershoot	VCUS	0.30					TBD	V	
Maximum overshoot area per 1 UI above VCOS	ACOS2	0.0038	0.0032	0.0028	0.0025	TBD	V-ns		
Maximum overshoot area per 1 UI between VDD and VDOS	ACOS1	0.1125	0.0964	0.0844	0.0750	TBD	V-ns		
Maximum undershoot area per 1 UI below VSS	ACUS	0.1144	0.0980	0.0858	0.0762	TBD	V-ns		
(CK_t, CK_c)									

NOTE :
 1) The value of VCOS matches VDD absolute max as defined in Table 5 Absolute Maximum DC Ratings if VDD equals VDD max as defined in Table 6 Recommended DC Operating Conditions. If VDD is above the recommended operating conditions, VCOS remains at VDD absolute max as defined in Table 5.

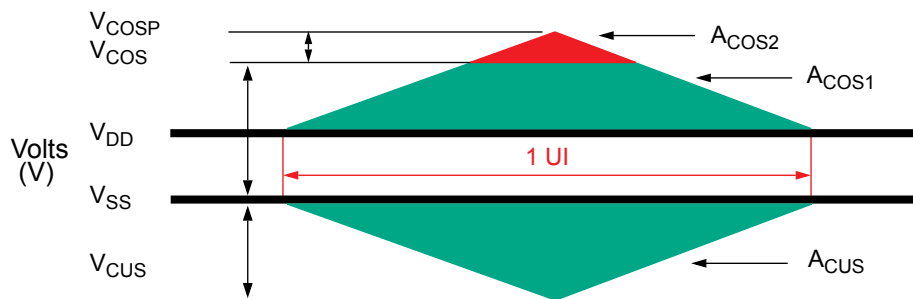

Figure 5. Clock Overshoot and Undershoot Definition

10.3.6 Data, Strobe and Mask Overshoot and Undershoot Specifications

[Table 13] AC overshoot/undershoot specification for Data, Strobe and Mask

Parameter	Symbol	Specification					Unit	NOTE	
		DDR4-1600	DDR4-1866	DDR4-2133	DDR4-2400	DDR4-2666			
Maximum peak amplitude above VDOS	VDOSP	0.16	0.16	0.16	0.16	TBD	V		
Upper boundary of overshoot area ADOS1	VDOS	VDDQ + 0.24					TBD	V	1
Lower boundary of undershoot area ADUS1	VDUS	0.30	0.30	0.30	0.30	TBD	V	2	
Maximum peak amplitude below VDUS	VDUSP	0.10	0.10	0.10	0.10	TBD	V		
Maximum overshoot area per 1 UI above VDOS	ADOS2	0.0150	0.0129	0.0113	0.0100	TBD	V-ns		
Maximum overshoot area per 1 UI between VDDQ and VDOS	ADOS1	0.1050	0.0900	0.0788	0.0700	TBD	V-ns		
Maximum undershoot area per 1 UI between VSSQ and VDUS1	ADUS1	0.1050	0.0900	0.0788	0.0700	TBD	V-ns		
Maximum undershoot area per 1 UI below VDUS	ADUS2	0.0150	0.0129	0.0113	0.0100	TBD	V-ns		

NOTE :
 1) The value of VDOS matches (VIN, VOUT) max as defined in Table 5 Absolute Maximum DC Ratings if VDDQ equals VDDQ max as defined in Table 6 Recommended DC Operating Conditions. If VDDQ is above the recommended operating conditions, VDOS remains at (VIN, VOUT) max as defined in Table 5.
 2) The value of VDUS matches (VIN, VOUT) min as defined in Table 5 Absolute Maximum DC Ratings

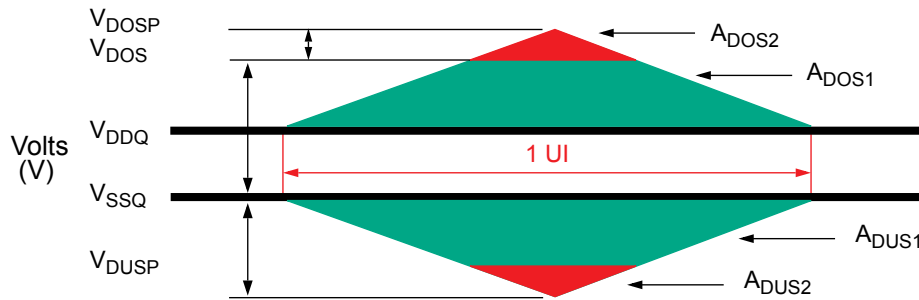

Figure 6. Data, Strobe and Mask Overshoot and Undershoot Definition

10.4 Slew Rate Definitions

10.4.1 Slew Rate Definitions for Differential Input Signals (CK)

Input slew rate for differential signals (CK_t, CK_c) are defined and measured as shown in Table 14 and Figure 7.

[Table 14] Differential Input Slew Rate Definition

Description	Measured		Defined by
	from	to	
Differential input slew rate for rising edge (CK _t - CK _c)	V _{ILdiffmax}	V _{IHdiffmin}	$[V_{IHdiffmin} - V_{ILdiffmax}] / \Delta TR_{diff}$
Differential input slew rate for falling edge (CK _t - CK _c)	V _{IHdiffmin}	V _{ILdiffmax}	$[V_{IHdiffmin} - V_{ILdiffmax}] / \Delta TF_{diff}$

NOTE :

1) The differential signal (i.e., CK_t - CK_c) must be linear between these thresholds.

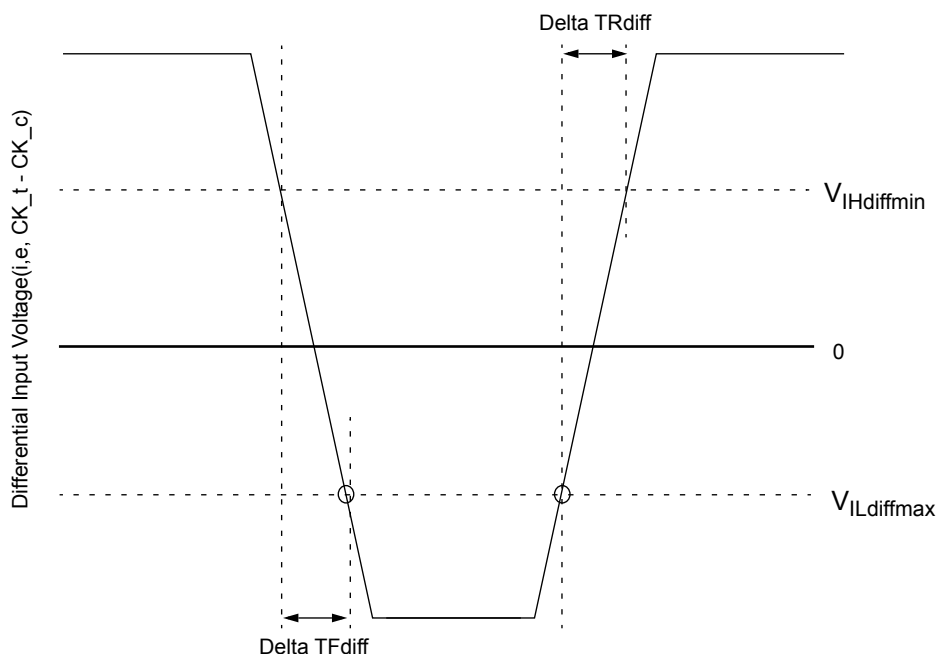

Figure 7. Differential Input Slew Rate Definition for CK_t, CK_c

10.4.2 Slew Rate Definition for Single-ended Input Signals (CMD/ADD)

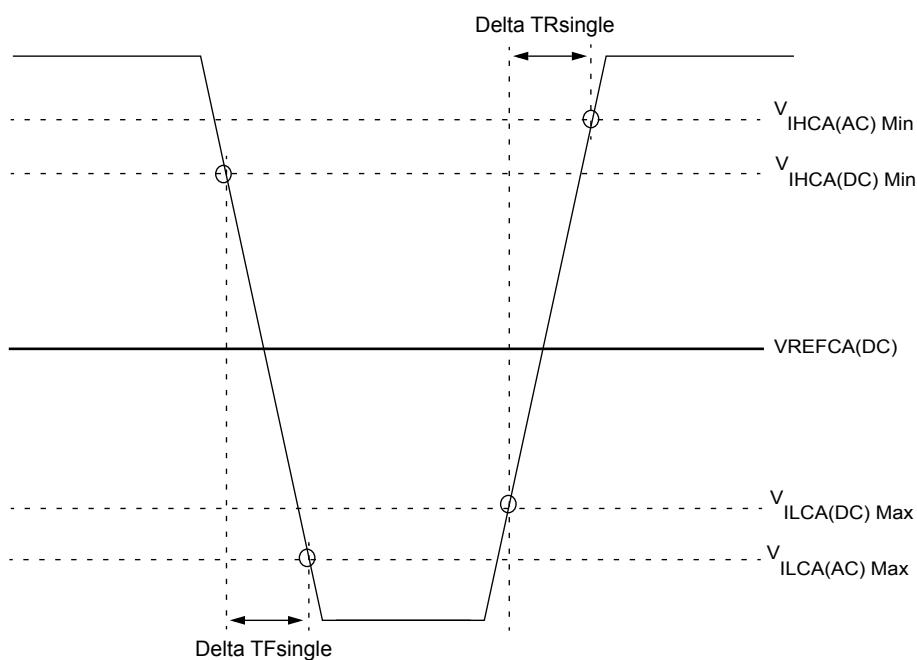

Figure 8. Single-ended Input Slew Rate definition for CMD and ADD

NOTE :

- 1) Single-ended input slew rate for rising edge = $\{V_{IHCA(AC)Min} - V_{ILCA(DC)Max}\} / \Delta T_{Rsingle}$.
- 2) Single-ended input slew rate for falling edge = $\{V_{IHCA(DC)Min} - V_{ILCA(AC)Max}\} / \Delta T_{Fsingle}$.
- 3) Single-ended signal rising edge from $V_{ILCA(DC)Max}$ to $V_{IHCA(DC)Min}$ must be monotonic slope.
- 4) Single-ended signal falling edge from $V_{IHCA(DC)Min}$ to $V_{ILCA(DC)Max}$ must be monotonic slope.

10.5 Differential Input Cross Point Voltage

To guarantee tight setup and hold times as well as output skew parameters with respect to clock, each cross point voltage of differential input signals (CK_t, CK_c) must meet the requirements in Table 15. The differential input cross point voltage VIX is measured from the actual cross point of true and complement signals to the midlevel between of VDD and VSS.

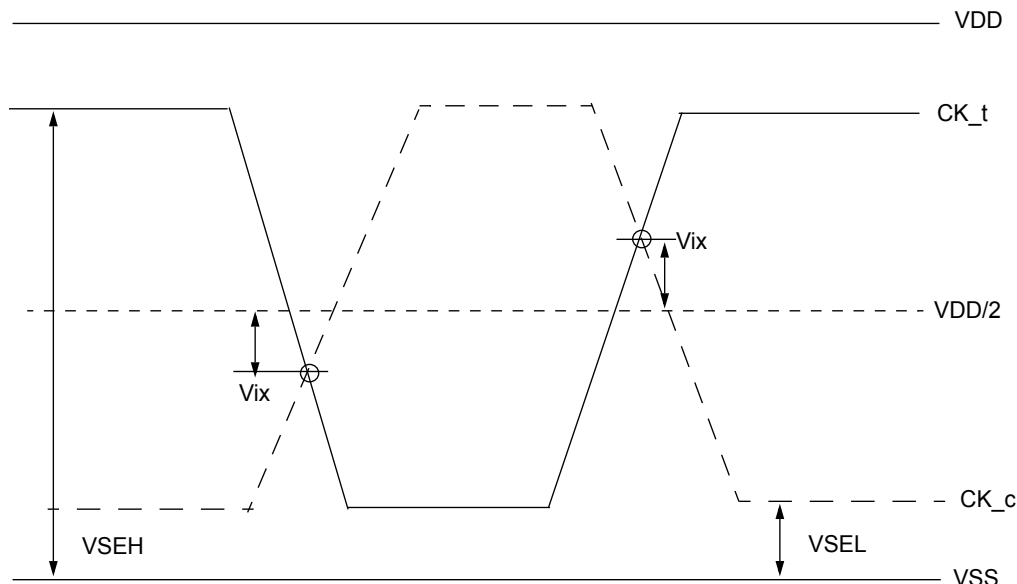

Figure 9. Vix Definition (CK)

[Table 15] Cross Point Voltage for Differential Input Signals (CK)

Symbol	Parameter	DDR4-1600/1866/2133			
		min		max	
-	Area of VSEH, VSEL	$VSEL < VDD/2 - 145mV$	$VDD/2 - 145mV \leq VSEL \leq VDD/2 - 100mV$	$VDD/2 + 100mV \leq VSEH \leq VDD/2 + 145mV$	$VDD/2 + 145mV < VSEH$
VIX(CK)	Differential Input Cross Point Voltage relative to VDD/2 for CK _t , CK _c	-120mV	$-(VDD/2 - VSEL) + 25mV$	$(VSEH - VDD/2) - 25mV$	120mV

Symbol	Parameter	DDR4-2400			
		min		max	
-	Area of VSEH, VSEL	$VSEL < VDD/2 - 145 mV$	$VDD/2 - 145 mV \leq VSEL \leq VDD/2 - 100 mV$	$VDD/2 + 100 mV \leq VSEH \leq VDD/2 + 145 mV$	$VDD/2 + 145 mV < VSEH$
VIX(CK)	Differential Input Cross Point Voltage relative to VDD/2 for CK _t , CK _c	-120mV	$-(VDD/2 - VSEL) + 25 mV$	$(VSEH - VDD/2) - 25 mV$	120mV

Symbol	Parameter	DDR4-2666			
		min		max	
-	Area of VSEH, VSEL	$VSEL < VDD/2 - 145 mV$	$VDD/2 - 145 mV \leq VSEL \leq VDD/2 - 100 mV$	$VDD/2 + 100 mV \leq VSEH \leq VDD/2 + 145 mV$	$VDD/2 + 145 mV < VSEH$
VIX(CK)	Differential Input Cross Point Voltage relative to VDD/2 for CK _t , CK _c	-110 mV	$-(VDD/2 - VSEL) + 30 mV$	$(VSEH - VDD/2) - 30 mV$	110mV

10.6 CMOS rail to rail Input Levels

10.6.1 CMOS rail to rail Input Levels for RESET_n

[Table 16] CMOS rail to rail Input Levels for RESET_n

Parameter	Symbol	Min	Max	Unit	NOTE
AC Input High Voltage	VIH(AC)_RESET	0.8*VDD	VDD	V	6
DC Input High Voltage	VIH(DC)_RESET	0.7*VDD	VDD	V	2
DC Input Low Voltage	VIL(DC)_RESET	VSS	0.3*VDD	V	1
AC Input Low Voltage	VIL(AC)_RESET	VSS	0.2*VDD	V	7
Rising time	TR_RESET	-	1.0	us	4
RESET pulse width	tPW_RESET	1.0	-	us	3,5

- NOTE :**
- 1) After RESET_n is registered LOW, RESET_n level shall be maintained below VIL(DC)_RESET during tPW_RESET, otherwise, SDRAM may not be reset.
 - 2) Once RESET_n is registered HIGH, RESET_n level must be maintained above VIH(DC)_RESET, otherwise, SDRAM operation will not be guaranteed until it is reset asserting RESET_n signal LOW.
 - 3) RESET is destructive to data contents.
 - 4) No slope reversal(ringback) requirement during its level transition from Low to High.
 - 5) This definition is applied only "Reset Procedure at Power Stable".
 - 6) Overshoot might occur. It should be limited by the Absolute Maximum DC Ratings.
 - 7) Undershoot might occur. It should be limited by Absolute Maximum DC Ratings.

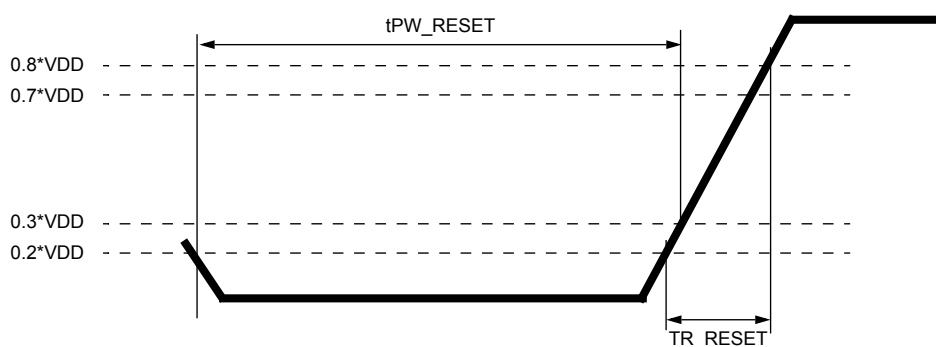

Figure 10. RESET_n Input Slew Rate Definition

10.7 AC and DC Logic Input Levels for DQS Signals

10.7.1 Differential signal definition

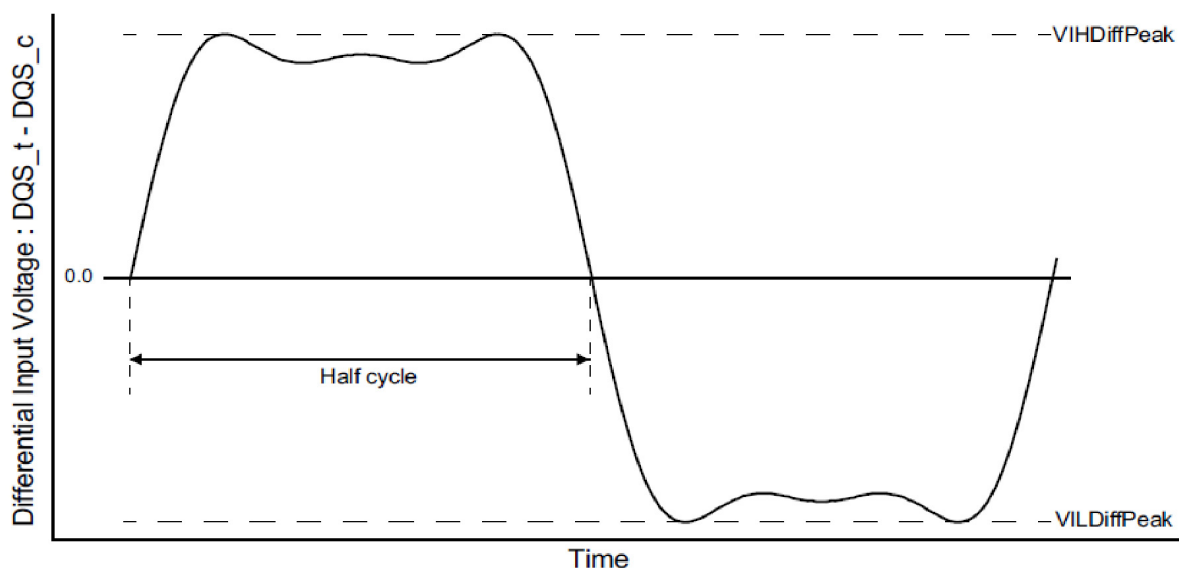

Figure 11. Definition of differential DQS Signal AC-swing Level

10.7.2 Differential swing requirements for DQS (DQS_t - DQS_c)

[Table 17] Differential AC and DC Input Levels for DQS

Symbol	Parameter	DDR4-1600, 1866, 2133		DDR4-2400		DDR4-2666		Unit	Note
		Min	Max	Min	Max	Min	Max		
VIHDiffPeak	VIH.DIFF.Peak Voltage	186	Note2	160	Note2	150	Note2	mV	1
VILDiffPeak	VIL.DIFF.Peak Voltage	Note2	-186	Note2	-160	Note2	-150	mV	1

- NOTE :
- 1) Used to define a differential signal slew-rate.
 - 2) These values are not defined; however, the differential signals DQS_t - DQS_c, need to be within the respective limits Overshoot, Undershoot Specification for single-ended signals.

10.7.3 Peak voltage calculation method

The peak voltage of Differential DQS signals are calculated in a following equation.

$$VIH.DIFF.Peak\ Voltage = \text{Max}(f(t))$$

$$VIL.DIFF.Peak\ Voltage = \text{Min}(f(t))$$

$$f(t) = VDQS_t - VDQS_c$$

The Max(f(t)) or Min(f(t)) used to determine the midpoint which to reference the +/-35% window of the exempt non-monotonic signaling shall be the smallest peak voltage observed in all ui's.

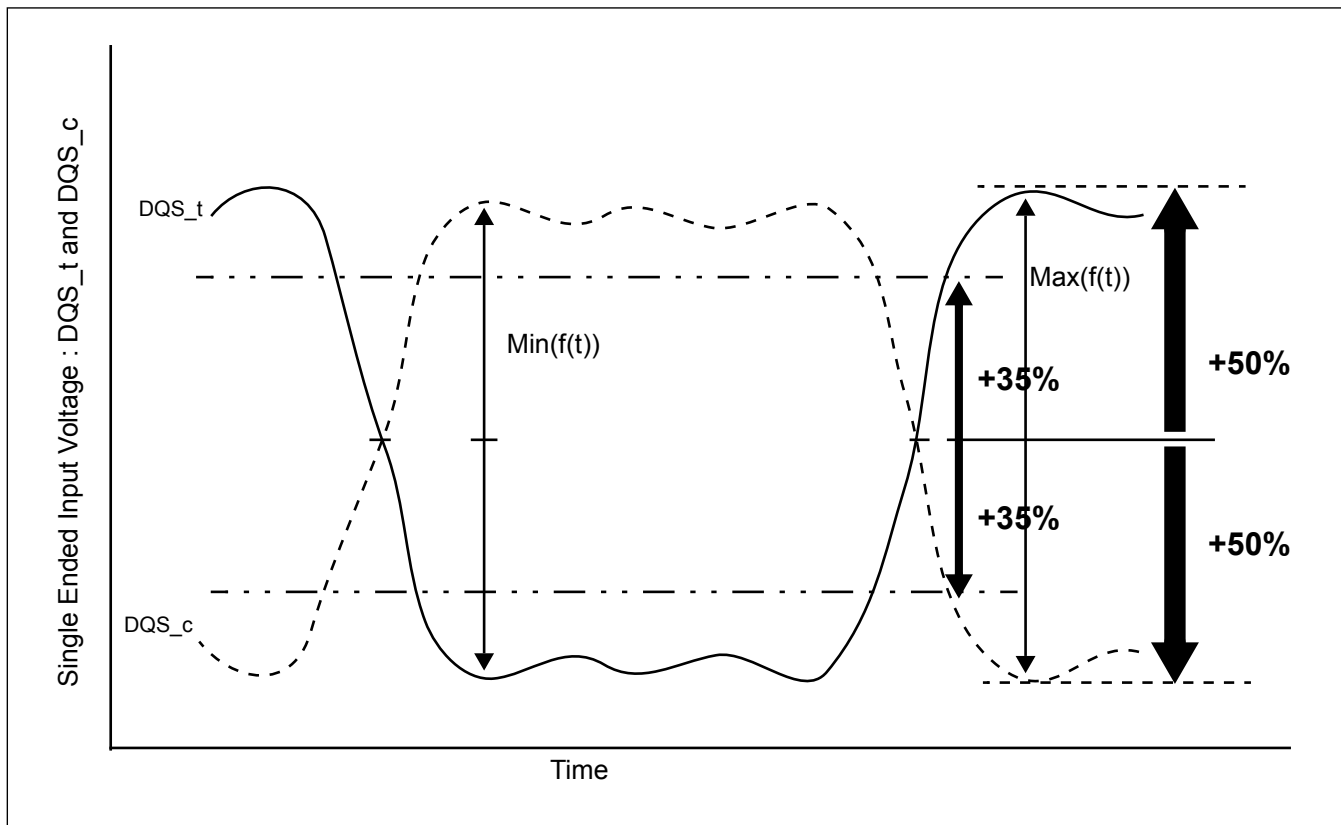

Figure 12. Definition of differential DQS Peak Voltage and rage of exempt non-monotonic signaling

10.7.4 Differential Input Cross Point Voltage

To achieve tight RxMask input requirements as well as output skew parameters with respect to strobe, the cross point voltage of differential input signals (DQS_t, DQS_c) must meet the requirements in Table 18. The differential input cross point voltage VIX_{DQS} (VIX_{DQS_FR} and VIX_{DQS_RF}) is measured from the actual cross point of DQS_t, DQS_c relative to the VDQSmid of the DQS_t and DQS_c signals.

VDQSmid is the midpoint of the minimum levels achieved by the transitioning DQS_t and DQS_c signals, and noted by VDQSmid. VDQSmid is the difference between the lowest horizontal tangent above VDQSmid of the transitioning DQS signals and the highest horizontal tangent below VDQSmid of the transitioning DQS signals.

A non-monotonic transitioning signal's ledge is exempt or not used in determination of a horizontal tangent provided the said ledge occurs within +/- 35% of the midpoint of either VIH.DIFF.Peak Voltage (DQS_t rising) or VIL.DIFF.Peak Voltage (DQS_c rising), refer to Figure 12. A secondary horizontal tangent resulting from a ring-back transition is also exempt in determination of a horizontal tangent. That is, a falling transition's horizontal tangent is derived from its negative slope to zero slope transition (point A in Figure 13) and a ring-back's horizontal tangent derived from its positive slope to zero slope transition (point B in Figure 13) is not a valid horizontal tangent; and a rising transition's horizontal tangent is derived from its positive slope to zero slope transition (point C in Figure 13) and a ring-back's horizontal tangent derived from its negative slope to zero slope transition (point D in Figure 13) is not a valid horizontal tangent.

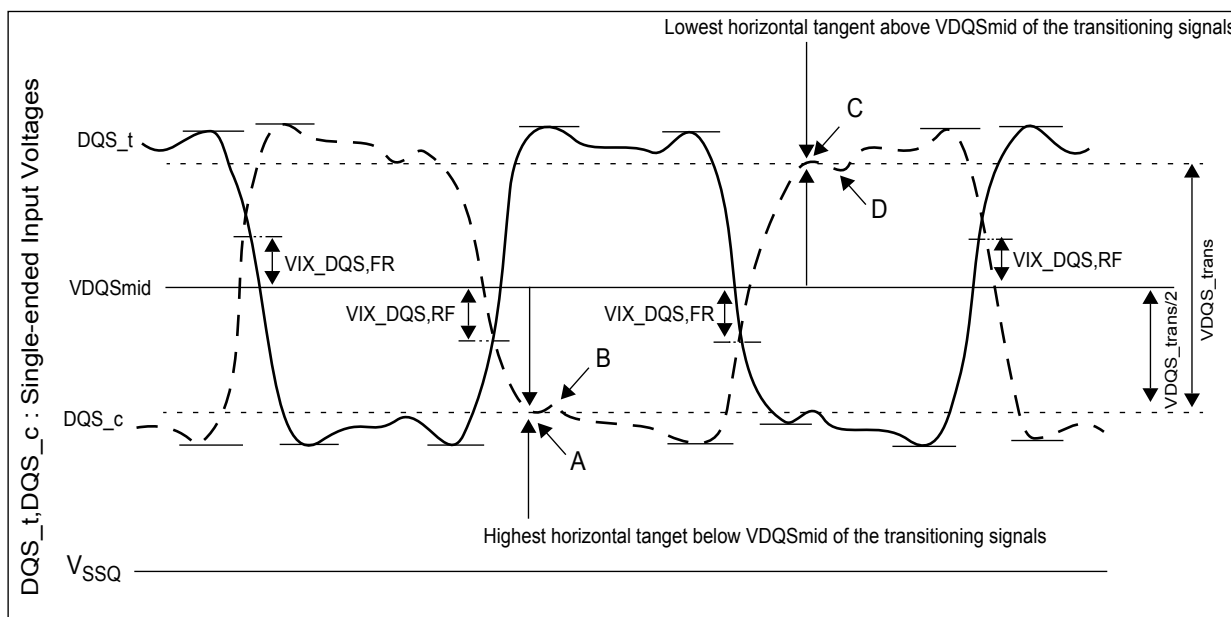

Figure 13. Vix Definition (DQS)

[Table 18] Cross point voltage for DQS differential input signals

Symbol	Parameter	DDR4-1600/1866/2133/		DDR4-2666		Unit	Note
		Min	Max	Min	Max		
Vix_DQS_ratio	DQS _t and DQS _c crossing relative to the midpoint of the DQS _t and DQS _c signal swings	-	25	-	25	%	1, 2
VDQSmid_to_Vcent	VDQSmid offset relative to Vcent_DQ(midpoint)	-	min (VIHdiff,50)	-	min (VIHdiff,50)	mV	3, 4, 5

- NOTE :**
- 1) Vix_DQS_Ratio is DQS VIX crossing (Vix_DQS_FR or Vix_DQS_RF) divided by VDQSmid. VDQSmid is the difference between the lowest horizontal tangent above VDQSmid of the transitioning DQS signals and the highest horizontal tangent below VDQSmid of the transitioning DQS signals.
 - 2) VDQSmid will be similar to the VREFDQ internal setting value obtained during Vref Training if the DQS and DQs drivers and paths are matched.
 - 3) The maximum limit shall not exceed the smaller of VIHdiff minimum limit or 50mV.
 - 4) VIX measurements are only applicable for transitioning DQS_t and DQS_c signals when toggling data, preamble and high-z states are not applicable conditions.
 - 5) The parameter VDQSmid is defined for simulation and ATE testing purposes, it is not expected to be tested in a system.

10.7.5 Differential Input Slew Rate Definition

Input slew rate for differential signals (DQS_t, DQS_c) are defined and measured as shown in Figure 13 and Figure 14.

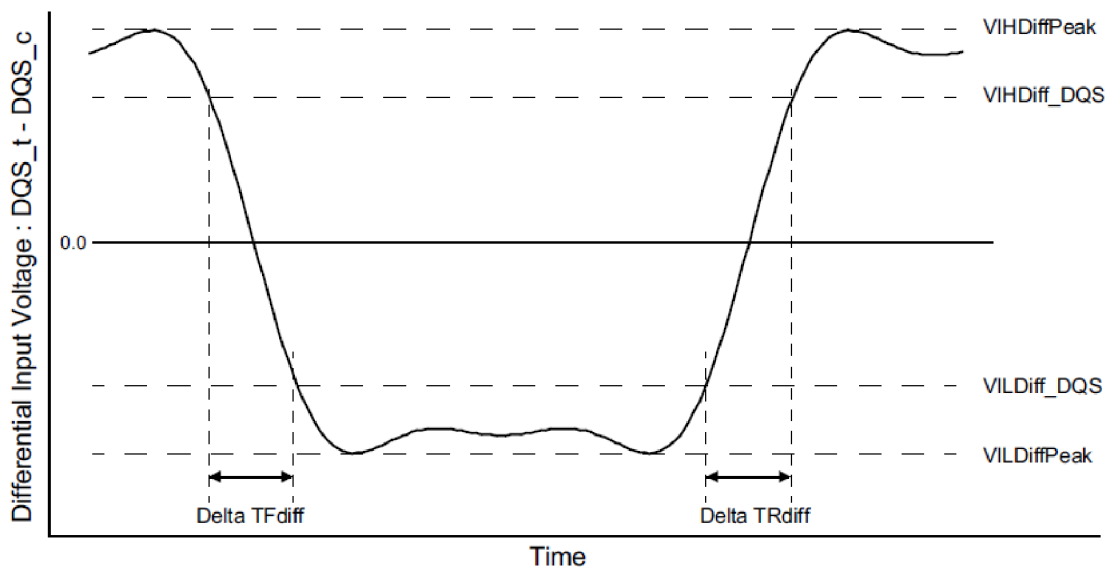

Figure 14. Differential Input Slew Rate Definition for DQS_t, DQS_c

NOTE :

- 1) Differential signal rising edge from VILDiff_DQS to VIHDiff_DQS must be monotonic slope.
- 2) Differential signal falling edge from VIHDiff_DQS to VILDiff_DQS must be monotonic slope.

[Table 19] Differential Input Slew Rate Definition for DQS_t, DQS_c

Description	Measured		Defined by
	From	To	
Differential input slew rate for rising edge (DQS _t - DQS _c)	VILDiff_DQS	VIHDiff_DQS	$ VILDiff_DQS - VIHDiff_DQS / \Delta TRdiff$
Differential input slew rate for falling edge (DQS _t - DQS _c)	VIHDiff_DQS	VILDiff_DQS	$ VILDiff_DQS - VIHDiff_DQS / \Delta TFdiff$

[Table 20] Differential Input Level for DQS_t, DQS_c

Symbol	Parameter	DDR4-1600/1866/2133		DDR4-2400/2666		Unit	NOTE
		Min	Max	Min	Max		
VIHDiff_DQS	Differential Input High	136	-	130	-	mV	
VILDiff_DQS	Differential Input Low	-	-136	-	-130	mV	

[Table 21] Differential Input Slew Rate for DQS_t, DQS_c

Symbol	Parameter	DDR4-1600/1866/2133/2400		DDR4-2666		Unit	NOTE
		Min	Max	Min	Max		
SRIdiff	Differential Input Slew Rate	3	18	2.5	18	V/ns	

11. AC AND DC OUTPUT MEASUREMENT LEVELS

11.1 Output Driver DC Electrical Characteristics

The DDR4 driver supports two different Ron values. These Ron values are referred as strong(low Ron) and weak mode(high Ron). A functional representation of the output buffer is shown in the figure below. Output driver impedance RON is defined as follows:

The individual pull-up and pull-down resistors ($R_{ON_{Pu}}$ and $R_{ON_{Pd}}$) are defined as follows:

$$R_{ON_{Pu}} = \frac{V_{DDQ} - V_{out}}{|I_{out}|} \quad \text{under the condition that } R_{ON_{Pd}} \text{ is off}$$

$$R_{ON_{Pd}} = \frac{V_{out}}{|I_{out}|} \quad \text{under the condition that } R_{ON_{Pu}} \text{ is off}$$

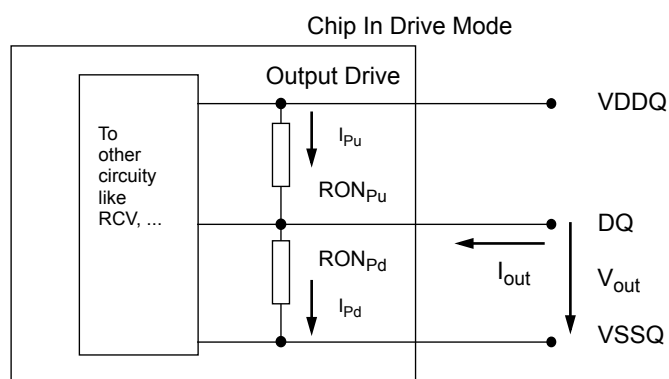

Figure 15. Output driver

[Table 22] Output Driver DC Electrical Characteristics, assuming RZQ=240ohm; entire operating temperature range; after proper ZQ calibration

RON _{NOM}	Resistor	Vout	Min	Nom	Max	Unit	NOTE
34Ω	RON34Pd	VOLdc= 0.5*VDDQ	0.73	1	1.1	RZQ/7	1,2
		VOMdc= 0.8* VDDQ	0.83	1	1.1	RZQ/7	1,2
		VOHdc= 1.1* VDDQ	0.83	1	1.25	RZQ/7	1,2
	RON34Pu	VOLdc= 0.5* VDDQ	0.9	1	1.25	RZQ/7	1,2
		VOMdc= 0.8* VDDQ	0.9	1	1.1	RZQ/7	1,2
		VOHdc= 1.1* VDDQ	0.8	1	1.1	RZQ/7	1,2
48Ω	RON48Pd	VOLdc= 0.5*VDDQ	0.73	1	1.1	RZQ/5	1,2
		VOMdc= 0.8* VDDQ	0.83	1	1.1	RZQ/5	1,2
		VOHdc= 1.1* VDDQ	0.83	1	1.25	RZQ/5	1,2
	RON48Pu	VOLdc= 0.5* VDDQ	0.9	1	1.25	RZQ/5	1,2
		VOMdc= 0.8* VDDQ	0.9	1	1.1	RZQ/5	1,2
		VOHdc= 1.1* VDDQ	0.8	1	1.1	RZQ/5	1,2
Mismatch between pull-up and pull-down, MMPuPd		VOMdc= 0.8* VDDQ	-10	-	17	%	1,2,3,4
Mismatch DQ-DQ within byte variation pull-up, MMPudd		VOMdc= 0.8* VDDQ	-	-	10	%	1,2,4
Mismatch DQ-DQ within byte variation pull-dn, MMPddd		VOMdc= 0.8* VDDQ	-	-	10	%	1,2,4

NOTE :

- 1) The tolerance limits are specified after calibration with stable voltage and temperature. For the behavior of the tolerance limits if temperature or voltage changes after calibration, see following section on voltage and temperature sensitivity (TBD).
- 2) Pull-up and pull-dn output driver impedances are recommended to be calibrated at 0.8 * VDDQ. Other calibration schemes may be used to achieve the linearity spec shown above, e.g. calibration at 0.5 * VDDQ and 1.1 * VDDQ.
- 3) Measurement definition for mismatch between pull-up and pull-down, MMPuPd : Measure RONPu and RONPD both at 0.8*VDD separately; Ronnom is the nominal Ron value

$$MMPuPd = \frac{RONPu - RONPd}{RONNOM} * 100$$

- 4) RON variance range ratio to RON Nominal value in a given component, including DQS_t and DQS_c.

$$MMPudd = \frac{RONPuMax - RONPuMin}{RONNOM} * 100$$

$$MMPddd = \frac{RONPdMax - RONPdMin}{RONNOM} * 100$$

- 5) This parameter of x16 device is specified for Uper byte and Lower byte.

11.1.1 Alert_n output Drive Characteristic

A functional representation of the output buffer is shown in the figure below. Output driver impedance RON is defined as follows:

$$RON_{Pd} = \frac{V_{out}}{|I_{out}|} \text{ under the condition that } RON_{Pu} \text{ is off}$$

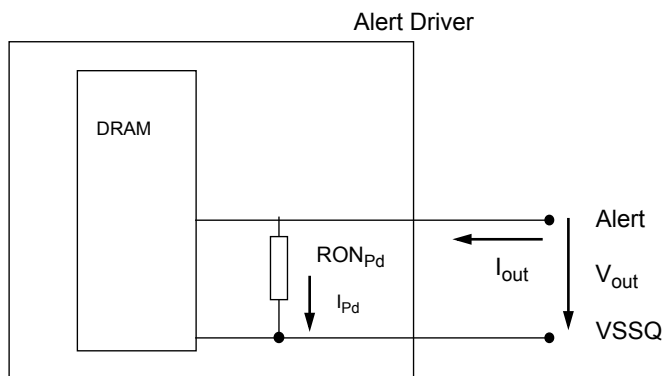

Resistor	Vout	Min	Max	Unit	NOTE
RON _{Pd}	V _{OLdc} = 0.1 * VDDQ	0.3	1.2	34Ω	1
	V _{OMdc} = 0.8 * VDDQ	0.4	1.2	34Ω	1
	V _{OHdc} = 1.1 * VDDQ	0.4	1.4	34Ω	1

NOTE:
1) VDDQ voltage is at VDDQ DC. VDDQ DC definition is TBD.

11.1.2 Output Driver Characteristic of Connectivity Test (CT) Mode

Following Output driver impedance RON will be applied Test Output Pin during Connectivity Test (CT) Mode. The individual pull-up and pull-down resistors (RONPu_CT and RONPd_CT) are defined as follows:

$$RON_{Pu_CT} = \frac{V_{DDQ} - V_{OUT}}{|I_{out}|}$$

$$RON_{Pd_CT} = \frac{V_{OUT}}{|I_{out}|}$$

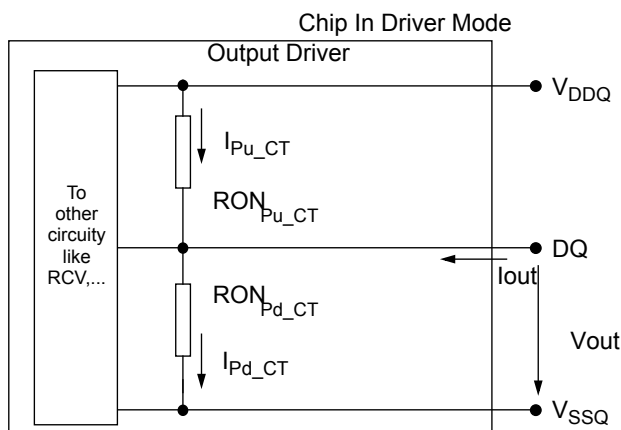

Figure 16. Output Driver

RON _{NOM_CT}	Resistor	Vout	Max	Units	NOTE
34Ω	RON _{Pd_CT}	VOB _{dc} = 0.2 x V _{DDQ}	1.9	34Ω	1
		VOL _{dc} = 0.5 x V _{DDQ}	2.0	34Ω	1
		VOM _{dc} = 0.8 x V _{DDQ}	2.2	34Ω	1
		VOH _{dc} = 1.1 x V _{DDQ}	2.5	34Ω	1
	RON _{Pu_CT}	VOB _{dc} = 0.2 x V _{DDQ}	2.5	34Ω	1
		VOL _{dc} = 0.5 x V _{DDQ}	2.2	34Ω	1
		VOM _{dc} = 0.8 x V _{DDQ}	2.0	34Ω	1
		VOH _{dc} = 1.1 x V _{DDQ}	1.9	34Ω	1

NOTE :

1) Connectivity test mode uses un-calibrated drivers, showing the full range over PVT. No mismatch between pull up and pull down is defined.

11.2 Single-ended AC & DC Output Levels

[Table 23] Single-ended AC & DC Output Levels

Symbol	Parameter	DDR4-1600/1866/2133/2400/2666	Units	NOTE
$V_{OH}(DC)$	DC output high measurement level (for IV curve linearity)	$1.1 \times V_{DDQ}$	V	
$V_{OM}(DC)$	DC output mid measurement level (for IV curve linearity)	$0.8 \times V_{DDQ}$	V	
$V_{OL}(DC)$	DC output low measurement level (for IV curve linearity)	$0.5 \times V_{DDQ}$	V	
$V_{OH}(AC)$	AC output high measurement level (for output SR)	$(0.7 + 0.15) \times V_{DDQ}$	V	1
$V_{OL}(AC)$	AC output low measurement level (for output SR)	$(0.7 - 0.15) \times V_{DDQ}$	V	1

NOTE :

1) The swing of $\pm 0.15 \times V_{DDQ}$ is based on approximately 50% of the static single-ended output peak-to-peak swing with a driver impedance of $RZQ/7\Omega$ and an effective test load of 50Ω to $V_{TT} = V_{DDQ}$.

11.3 Differential AC & DC Output Levels

[Table 24] Differential AC & DC Output Levels

Symbol	Parameter	DDR4-1600/1866/2133/2400/2666	Units	NOTE
$V_{OHdiff}(AC)$	AC differential output high measurement level (for output SR)	$+0.3 \times V_{DDQ}$	V	1
$V_{OLdiff}(AC)$	AC differential output low measurement level (for output SR)	$-0.3 \times V_{DDQ}$	V	1

NOTE :

1) The swing of $\pm 0.3 \times V_{DDQ}$ is based on approximately 50% of the static differential output peak-to-peak swing with a driver impedance of $RZQ/7\Omega$ and an effective test load of 50Ω to $V_{TT} = V_{DDQ}$ at each of the differential outputs.

11.4 Single-ended Output Slew Rate

With the reference load for timing measurements, output slew rate for falling and rising edges is defined and measured between $V_{OL(AC)}$ and $V_{OH(AC)}$ for single ended signals as shown in Table 25 and Figure 17.

[Table 25] Single-ended Output Slew Rate Definition

Description	Measured		Defined by
	From	To	
Single ended output slew rate for rising edge	$V_{OL(AC)}$	$V_{OH(AC)}$	$[V_{OH(AC)} - V_{OL(AC)}] / \Delta TR_{se}$
Single ended output slew rate for falling edge	$V_{OH(AC)}$	$V_{OL(AC)}$	$[V_{OH(AC)} - V_{OL(AC)}] / \Delta TF_{se}$

NOTE :
 1) Output slew rate is verified by design and characterization, and may not be subject to production test.

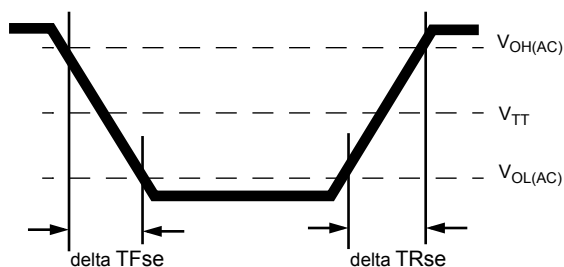

Figure 17. Single-ended Output Slew Rate Definition

[Table 26] Single-ended Output Slew Rate

Parameter	Symbol	DDR4-1600		DDR4-1866		DDR4-2133		DDR4-2400		DDR4-2666		Units
		Min	Max	Min	Max	Min	Max	Min	Max	Min	Max	
Single ended output slew rate	SRQse	4	9	4	9	4	9	4	9	4	9	V/ns

Description: SR: Slew Rate
 Q: Query Output (like in DQ, which stands for Data-in, Query-Output)
 se: Single-ended Signals
 For Ron = RZQ/7 setting

NOTE :
 1. In two cases, a maximum slew rate of 12 V/ns applies for a single DQ signal within a byte lane.
 -Case 1 is defined for a single DQ signal within a byte lane which is switching into a certain direction (either from high to low or low to high) while all remaining DQ signals in the same byte lane are static (i.e. they stay at either high or low).
 -Case 2 is defined for a single DQ signal within a byte lane which is switching into a certain direction (either from high to low or low to high) while all remaining DQ signals in the same byte lane are switching into the opposite direction (i.e. from low to high or high to low respectively). For the remaining DQ signal switching into the opposite direction, the regular maximum limit of 9 V/ns applies

11.5 Differential Output Slew Rate

With the reference load for timing measurements, output slew rate for falling and rising edges is defined and measured between VOLdiff(AC) and VOHdiff(AC) for differential signals as shown in Table 27 and Figure 18.

[Table 27] Differential Output Slew Rate Definition

Description	Measured		Defined by
	From	To	
Differential output slew rate for rising edge	VOLdiff(AC)	VOHdiff(AC)	$[V_{OHdiff(AC)} - V_{OLdiff(AC)}] / \Delta TR_{diff}$
Differential output slew rate for falling edge	VOHdiff(AC)	VOLdiff(AC)	$[V_{OHdiff(AC)} - V_{OLdiff(AC)}] / \Delta TF_{diff}$

NOTE:
 1) Output slew rate is verified by design and characterization, and may not be subject to production test.

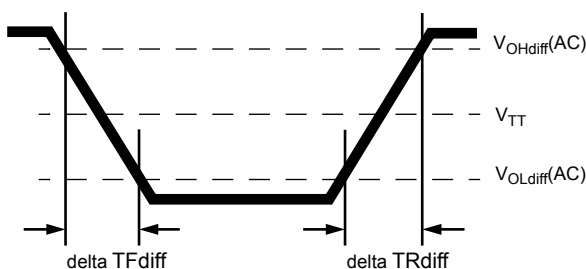

Figure 18. Differential Output Slew Rate Definition

[Table 28] Differential Output Slew Rate

Parameter	Symbol	DDR4-1600		DDR4-1866		DDR4-2133		DDR4-2400		DDR4-2666		Units
		Min	Max	Min	Max	Min	Max	Min	Max	Min	Max	
Differential output slew rate	SRQdiff	8	18	8	18	8	18	8	18	8	18	V/ns

Description:
 SR: Slew Rate
 Q: Query Output (like in DQ, which stands for Data-in, Query-Output)
 diff: Differential Signals
 For Ron = RZQ/7 setting

11.6 Single-ended AC & DC Output Levels of Connectivity Test Mode

Following output parameters will be applied for DDR4 SDRAM Output Signal during Connectivity Test Mode.

[Table 29] Single-ended AC & DC Output Levels of Connectivity Test Mode

Symbol	Parameter	DDR4-1600/1866/2133/2400/2666	Unit	Notes
$V_{OH(DC)}$	DC output high measurement level (for IV curve linearity)	1.1 x VDDQ	V	
$V_{OM(DC)}$	DC output mid measurement level (for IV curve linearity)	0.8 x VDDQ	V	
$V_{OL(DC)}$	DC output low measurement level (for IV curve linearity)	0.5 x VDDQ	V	
$V_{OB(DC)}$	DC output below measurement level (for IV curve linearity)	0.2 x VDDQ	V	
$V_{OH(AC)}$	AC output high measurement level (for output SR)	$V_{TT} + (0.1 \times V_{DDQ})$	V	1
$V_{OL(AC)}$	AC output below measurement level (for output SR)	$V_{TT} - (0.1 \times V_{DDQ})$	V	1

NOTE :

1) The effective test load is 50Ω terminated by $V_{TT} = 0.5 \times V_{DDQ}$.

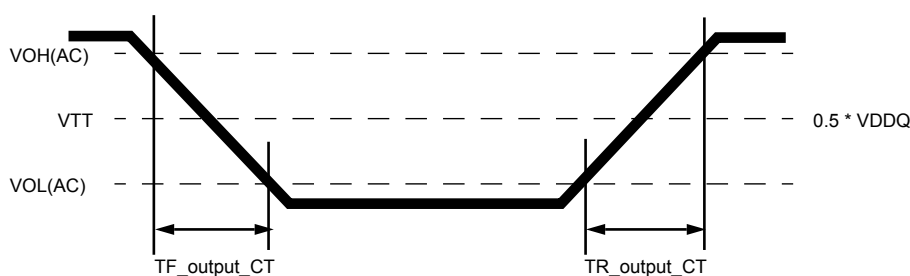

Figure 19. Output Slew Rate Definition of Connectivity Test Mode

[Table 30] Single-ended Output Slew Rate of Connectivity Test Mode

Parameter	Symbol	DDR4-1600/1866/2133/2400/2666		Unit	Notes
		Min	Max		
Output signal Falling time	TF_output_CT	-	10	ns/V	
Output signal Rising time	TR_output_CT	-	10	ns/V	

11.7 Test Load for Connectivity Test Mode Timing

The reference load for ODT timings is defined in Figure 20.

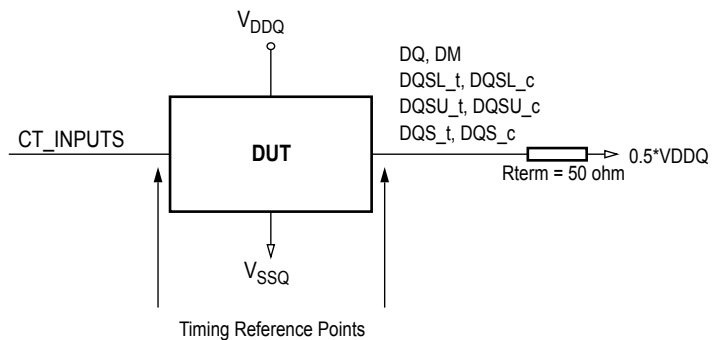

Figure 20. Connectivity Test Mode Timing Reference Load

12. SPEED BIN

[Table 31] DDR4-1600 Speed Bins and Operations

Speed Bin			DDR4-1600		Unit	NOTE	
CL-nRCD-nRP			11-11-11				
Parameter	Symbol	min	max				
Internal read command to first data	tAA	13.75 ¹³⁾ (13.50) ^{5),10)}	18.00	ns	11		
Internal read command to first data with read DBI enabled	tAA_DBI	tAA(min) + 2nCK	tAA(max) + 2nCK	ns	11		
ACT to internal read or write delay time	tRCD	13.75 (13.50) ^{5),10)}	-	ns	11		
PRE command period	tRP	13.75 (13.50) ^{5),10)}	-	ns	11		
ACT to PRE command period	tRAS	35	9 x tREFI	ns	11		
ACT to ACT or REF command period	tRC	48.75 (48.50) ^{5),10)}	-	ns	11		
	Normal	Read DBI					
CWL = 9	CL = 9	CL = 11 (Optional) ⁵⁾	tCK(AVG)	1.5 (Optional) ^{5),10)}	1.6	ns	1,2,3,4,10,13
	CL = 10	CL = 12	tCK(AVG)	Reserved		ns	1,2,3,4,10
CWL = 9,11	CL = 10	CL = 12	tCK(AVG)	Reserved		ns	1,2,3,4
	CL = 11	CL = 13	tCK(AVG)	1.25	<1.5	ns	1,2,3,4
	CL = 12	CL = 14	tCK(AVG)	1.25	<1.5	ns	1,2,3
Supported CL Settings			(9),11,12		nCK	12,13	
Supported CL Settings with read DBI			(11),13,14		nCK	12	
Supported CWL Settings			9,11		nCK		

[Table 32] DDR4-1866 Speed Bins and Operations

Speed Bin			DDR4-1866		Unit	NOTE	
CL-nRCD-nRP			13-13-13				
Parameter	Symbol		min	max			
Internal read command to first data	tAA		13.92 ¹³⁾ (13.50) ^{5),11)}	18.00	ns	11	
Internal read command to first data with read DBI enabled	tAA_DBI		tAA(min) + 2nCK	tAA(max) + 2nCK	ns	11	
ACT to internal read or write delay time	tRCD		13.92 (13.50) ^{5),11)}	-	ns	11	
PRE command period	tRP		13.92 (13.50) ^{5),11)}	-	ns	11	
ACT to PRE command period	tRAS		34	9 x tREFI	ns	11	
ACT to ACT or REF command period	tRC		47.92 (47.50) ^{5),11)}	-	ns	11	
	Normal	Read DBI					
CWL = 9	CL = 9	CL = 11 (Optional) ⁵⁾	tCK(AVG)	1.5 (Optional) ^{5),11)}	1.6	ns	1,2,3,4,10,13
			tCK(AVG)	Reserved			
CWL = 9,11	CL = 10	CL = 12	tCK(AVG)	Reserved		ns	4
	CL = 11	CL = 13	tCK(AVG)	1.25	<1.5 (Optional) ^{5),11)}	ns	1,2,3,4,6
				1.25			
CWL = 10,12	CL = 12	CL = 14	tCK(AVG)	Reserved		ns	1,2,3,4
	CL = 13	CL = 15	tCK(AVG)	1.071	<1.25	ns	1,2,3,4
	CL = 14	CL = 16	tCK(AVG)	1.071	<1.25	ns	1,2,3
Supported CL Settings			9,11,12,13,14		nCK	12,13	
Supported CL Settings with read DBI			11,13,14,15,16		nCK	12	
Supported CWL Settings			9,10,11,12		nCK		

[Table 33] DDR4-2133 Speed Bins and Operations

Speed Bin			DDR4-2133		Unit	NOTE	
CL-nRCD-nRP			15-15-15				
Parameter		Symbol	min	max			
Internal read command to first data		tAA	14.06 ¹³⁾ (13.50) ^{5),11)}	18.00	ns	11	
Internal read command to first data with read DBI enabled		tAA_DBI	tAA(min) + 3nCK	tAA(max) + 3nCK	ns	11	
ACT to internal read or write delay time		tRCD	14.06 (13.50) ^{5),11)}	-	ns	11	
PRE command period		tRP	14.06 (13.50) ^{5),11)}	-	ns	11	
ACT to PRE command period		tRAS	33	9 x tREFI	ns	11	
ACT to ACT or REF command period		tRC	47.06 (46.50) ^{5),11)}	-	ns	11	
	Normal	Read DBI					
CWL = 9	CL = 9	CL = 11 (Optional) ⁵⁾	tCK(AVG)	1.5	1.6	ns	1,2,3,4,10,13
				(Optional) ^{5),11)}			
	CL = 10	CL = 12	tCK(AVG)	Reserved		ns	1,2,3,10
CWL = 9,11	CL = 11	CL = 13	tCK(AVG)	1.25	<1.5	ns	1,2,3,4,7
				(Optional) ^{5),11)}			
	CL = 12	CL = 14	tCK(AVG)	1.25	<1.5	ns	1,2,3,7
CWL = 10,12	CL = 13	CL = 15	tCK(AVG)	1.071	<1.25	ns	1,2,3,4,7
				(Optional) ^{5),11)}			
	CL = 14	CL = 16	tCK(AVG)	1.071	<1.25	ns	1,2,3,7
CWL = 11,14	CL = 14	CL = 17	tCK(AVG)	Reserved		ns	1,2,3,4
	CL = 15	CL = 18	tCK(AVG)	0.937	<1.071	ns	1,2,3,4
	CL = 16	CL = 19	tCK(AVG)	0.937	<1.071	ns	1,2,3
Supported CL Settings			(9),(11), 12,(13),14,15,16		nCK	12,13	
Supported CL Settings with read DBI			(11),(13),14,(15),16,18,19		nCK		
Supported CWL Settings			9,10,11,12,14		nCK		

[Table 34] DDR4-2400 Speed Bins and Operations

Speed Bin			DDR4-2400		Unit	NOTE	
CL-nRCD-nRP			17-17-17				
Parameter	Symbol		min	max			
Internal read command to first data	tAA		14.16 (13.75) ^{5),11)}	18.00	ns	11	
Internal read command to first data with read DBI enabled	tAA_DBI		tAA(min) + 3nCK	tAA(max) + 3nCK	ns	11	
ACT to internal read or write delay time	tRCD		14.16 (13.75) ^{5),11)}	-	ns	11	
PRE command period	tRP		14.16 (13.75) ^{5),11)}	-	ns	11	
ACT to PRE command period	tRAS		32	9 x tREFI	ns	11	
ACT to ACT or REF command period	tRC		46.16 (45.75) ^{5),11)}	-	ns	11	
	Normal	Read DBI					
CWL = 9	CL = 9	CL = 11 (Optional) ⁵⁾	tCK(AVG)	Reserved		ns	1,2,3,4,10
	CL = 10	CL = 12	tCK(AVG)	1.5	1.6	ns	1,2,3,4,10
CWL = 9,11	CL = 10	CL = 12	tCK(AVG)	Reserved		ns	4
	CL = 11	CL = 13	tCK(AVG)	1.25	<1.5	ns	1,2,3,4,8
				(Optional) ^{5),11)}			
CL = 12	CL = 14	tCK(AVG)	1.25	<1.5	ns	1,2,3,8	
CWL = 10,12	CL = 12	CL = 14	tCK(AVG)	Reserved		ns	4
	CL = 13	CL = 15	tCK(AVG)	1.071	<1.25	ns	1,2,3,4,8
				(Optional) ^{5),11)}			
CL = 14	CL = 16	tCK(AVG)	1.071	<1.25	ns	1,2,3,8	
CWL = 11,14	CL = 14	CL = 17	tCK(AVG)	Reserved		ns	4
	CL = 15	CL = 18	tCK(AVG)	0.937	<1.071	ns	1,2,3,4,8
				(Optional) ^{5),11)}			
CL = 16	CL = 19	tCK(AVG)	0.937	<1.071	ns	1,2,3,8	
CWL = 12,16	CL = 15	CL = 18	tCK(AVG)	Reserved		ns	1,2,3,4
	CL = 16	CL = 19	tCK(AVG)	Reserved		ns	1,2,3,4
	CL = 17	CL = 20	tCK(AVG)	0.833	<0.937	ns	
	CL = 18	CL = 21	tCK(AVG)	0.833	<0.937	ns	1,2,3
Supported CL Settings			10,11,12,13,14,15,16,17,18		nCK	12	
Supported CL Settings with read DBI			12,13,14,15,16,18,19,20,21		nCK		
Supported CWL Settings			9,10,11,12,14,16		nCK		

[Table 35] DDR4-2666 Speed Bins and Operations

Speed Bin			DDR4-2666		Unit	NOTE
CL-nRCD-nRP			19-19-19			
Parameter	Symbol		min	max		
Internal read command to first data	tAA		14.25 ¹³⁾ (13.75) ^{5),11)}	18.00	ns	11
Internal read command to first data with read DBI enabled	tAA_DBI		tAA(min) + 3nCK	tAA(max) + 3nCK	ns	11
ACT to internal read or write delay time	tRCD		14.25 (13.75) ^{5),11)}	-	ns	11
PRE command period	tRP		14.25 ¹³⁾ (13.75) ^{5),11)}	-	ns	11
ACT to PRE command period	tRAS		32	9 x tREFI	ns	11
ACT to ACT or REF command period	tRC		46.25 (45.75) ^{5),11)}	-	ns	11
	Normal	Read DBI				
CWL = 9	CL = 9	CL = 11	tCK(AVG)	Reserved	ns	1,2,3,4,10
	CL = 10	CL = 12	tCK(AVG)	1.5 1.6	ns	1,2,3,10
CWL = 9,11	CL = 10	CL = 12	tCK(AVG)	Reserved	ns	4
	CL = 11	CL = 13	tCK(AVG)	1.25 <1.5 (Optional) ^{5),11)}	ns	1,2,3,4,9
	CL = 12	CL = 14	tCK(AVG)	1.25 <1.5	ns	1,2,3,9
CWL = 10,12	CL = 12	CL = 14	tCK(AVG)	Reserved	ns	4
	CL = 13	CL = 15	tCK(AVG)	1.071 <1.25 (Optional) ^{5),11)}	ns	1,2,3,4,9
	CL = 14	CL = 16	tCK(AVG)	1.071 <1.25	ns	1,2,3,9
CWL = 11,14	CL = 14	CL = 17	tCK(AVG)	Reserved	ns	4
	CL = 15	CL = 18	tCK(AVG)	0.937 <1.071 (Optional) ^{5),11)}	ns	1,2,3,4,9
	CL = 16	CL = 19	tCK(AVG)	0.937 <1.071	ns	1,2,3,9
CWL = 12,16	CL = 15	CL = 18	tCK(AVG)	Reserved	ns	4
	CL = 16	CL = 19	tCK(AVG)	Reserved	ns	1,2,3,4,9
	CL = 17	CL = 20	tCK(AVG)	0.833 <0.937 (Optional) ^{5),11)}	ns	1,2,3,4,9
	CL = 18	CL = 21	tCK(AVG)	0.833 <0.937	ns	1,2,3
CWL = 14,18	CL = 17	CL = 20	tCK(AVG)	Reserved	ns	1,2,3,4
	CL = 18	CL = 21	tCK(AVG)	Reserved	ns	1,2,3,4
	CL = 19	CL = 22	tCK(AVG)	0.75 <0.833	ns	1,2,3,4
	CL = 20	CL = 23	tCK(AVG)	0.75 <0.833	ns	1,2,3
Supported CL Settings			10,(11),12,(13),14,(15),16,(17),18,19,20		nCK	12
Supported CL Settings with read DBI			12,(13),14,(15),17,(18),19,(20),21,22,23		nCK	
Supported CWL Settings			9,10,11,12,14,16,18		nCK	

12.1 Speed Bin Table Note

Absolute Specification

- VDDQ = VDD = 1.20V +/- 0.06 V
- VPP = 2.5V +0.25/-0.125 V
- The values defined with above-mentioned table are DLL ON case.
- DDR4-1600, 1866, 2133, 2400 and 2666 Speed Bin Tables are valid only when Geardown Mode is disabled.

- 1) The CL setting and CWL setting result in tCK(avg).MIN and tCK(avg).MAX requirements. When making a selection of tCK(avg), both need to be fulfilled: Requirements from CL setting as well as requirements from CWL setting.
- 2) tCK(avg).MIN limits: Since CAS Latency is not purely analog - data and strobe output are synchronized by the DLL - all possible intermediate frequencies may not be guaranteed. CL in clock cycle is calculated from tAA following rounding algorithm defined in Section 13.5.
- 3) tCK(avg).MAX limits: Calculate $tCK(avg) = tAA.MAX / CL\ SELECTED$ and round the resulting tCK(avg) down to the next valid speed bin (i.e. 1.5ns or 1.25ns or 1.071ns or 0.937ns or 0.833ns). This result is tCK(avg).MAX corresponding to CL SELECTED.
- 4) 'Reserved' settings are not allowed. User must program a different value.
- 5) 'Optional' settings allow certain devices in the industry to support this setting, however, it is not a mandatory feature. Refer to supplier's data sheet and/or the DIMM SPD information if and how this setting is supported.
- 6) Any DDR4-1866 speed bin also supports functional operation at lower frequencies as shown in the table which are not subject to Production Tests but verified by Design/Characterization.
- 7) Any DDR4-2133 speed bin also supports functional operation at lower frequencies as shown in the table which are not subject to Production Tests but verified by Design/Characterization.
- 8) Any DDR4-2400 speed bin also supports functional operation at lower frequencies as shown in the table which are not subject to Production Tests but verified by Design/Characterization.
- 9) Any DDR4-2666 speed bin also supports functional operation at lower frequencies as shown in the table which are not subject to Production Tests but verified by Design/Characterization.
- 10) DDR4-1600 AC timing apply if DRAM operates at lower than 1600 MT/s data rate.
- 11) Parameters apply from tCK(avg) min to tCK(avg) max at all standard JEDEC clock period values as stated in the Speed Bin Tables.
- 12) CL number in parentheses, it means that these numbers are optional.
- 13) DDR4 SDRAM supports CL=9 as long as a system meets tAA(min).
- 14) Each speed bin lists the timing requirements that need to be supported in order for a given DRAM to be JEDEC compliant. JEDEC compliance does not require support for all speed bins within a given speed. JEDEC compliance requires meeting the parameters for a least one of the listed speed bins.

13. IDD AND IDDQ SPECIFICATION PARAMETERS AND TEST CONDITIONS

13.1 IDD, IPP and IDDQ Measurement Conditions

In this chapter, IDD, IPP and IDDQ measurement conditions such as test load and patterns are defined. Figure 21 shows the setup and test load for IDD, IPP and IDDQ measurements.

- IDD currents (such as IDD0, IDD0A, IDD1, IDD1A, IDD2N, IDD2NA, IDD2NL, IDD2NT, IDD2P, IDD2Q, IDD3N, IDD3NA, IDD3P, IDD4R, IDD4RA, IDD4W, IDD4WA, IDD5B, IDD5F2, IDD5F4, IDD6N, IDD6E, IDD6R, IDD6A, IDD7 and IDD8) are measured as time-averaged currents with all VDD balls of the DDR4 SDRAM under test tied together. Any IPP or IDDQ current is not included in IDD currents.
 - IPP currents have the same definition as IDD except that the current on the VPP supply is measured.
 - IDDQ currents (such as IDDQ2NT and IDDQ4R) are measured as time-averaged currents with all VDDQ balls of the DDR4 SDRAM under test tied together. Any IDD current is not included in IDDQ currents.
- Attention: IDDQ values cannot be directly used to calculate IO power of the DDR4 SDRAM. They can be used to support correlation of simulated IO power to actual IO power as outlined in Figure 22. In DRAM module application, IDDQ cannot be measured separately since VDD and VDDQ are using one merged-power layer in Module PCB.

For IDD, IPP and IDDQ measurements, the following definitions apply:

- “0” and “LOW” is defined as $V_{IN} \leq V_{ILAC(max)}$.
- “1” and “HIGH” is defined as $V_{IN} \geq V_{IHAC(min)}$.
- “MID-LEVEL” is defined as inputs are $V_{REF} = V_{DD} / 2$.
- Timings used for IDD, IPP and IDDQ Measurement-Loop Patterns are provided in Table 36.
- Basic IDD, IPP and IDDQ Measurement Conditions are described in Table 38.
- Detailed IDD, IPP and IDDQ Measurement-Loop Patterns are described in Table 39 through Table 46.
- IDD Measurements are done after properly initializing the DDR4 SDRAM. This includes but is not limited to setting
 - RON = RZQ/7 (34 Ohm in MR1);
 - RTT_NOM = RZQ/6 (40 Ohm in MR1);
 - RTT_WR = RZQ/2 (120 Ohm in MR2);
 - RTT_PARK = Disable;
 - Qoff = 0_B (Output Buffer enabled) in MR1;
 - TDQS_t disabled in MR1;
 - CRC disabled in MR2;
 - CA parity feature disabled in MR5;
 - Gear down mode disabled in MR3
 - Read/Write DBI disabled in MR5;
 - DM disabled in MR5
- Attention: The IDD, IPP and IDDQ Measurement-Loop Patterns need to be executed at least one time before actual IDD or IDDQ measurement is started.
- Define D = {CS_n, ACT_n, RAS_n, CAS_n, WE_n} := {HIGH, LOW, LOW, LOW, LOW} ; apply BG/BA changes when directed.
- Define D# = {CS_n, ACT_n, RAS_n, CAS_n, WE_n} := {HIGH, HIGH, HIGH, HIGH, HIGH} ; apply invert of BG/BA changes when directed above.

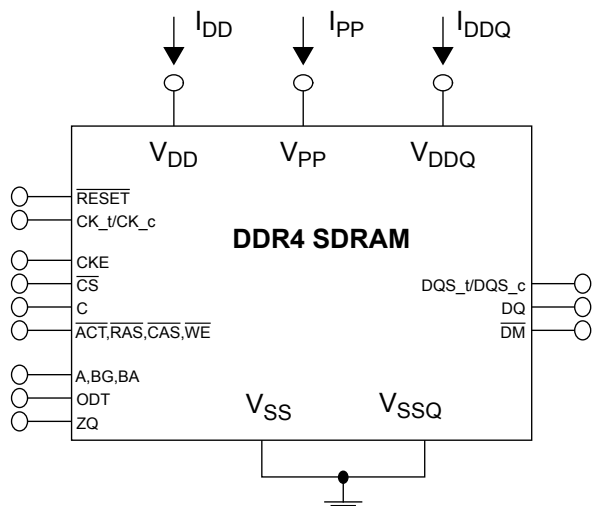

Figure 21. Measurement Setup and Test Load for IDD, IPP and IDDQ Measurements

NOTE :
 1) DIMM level Output test load condition may be different from above.

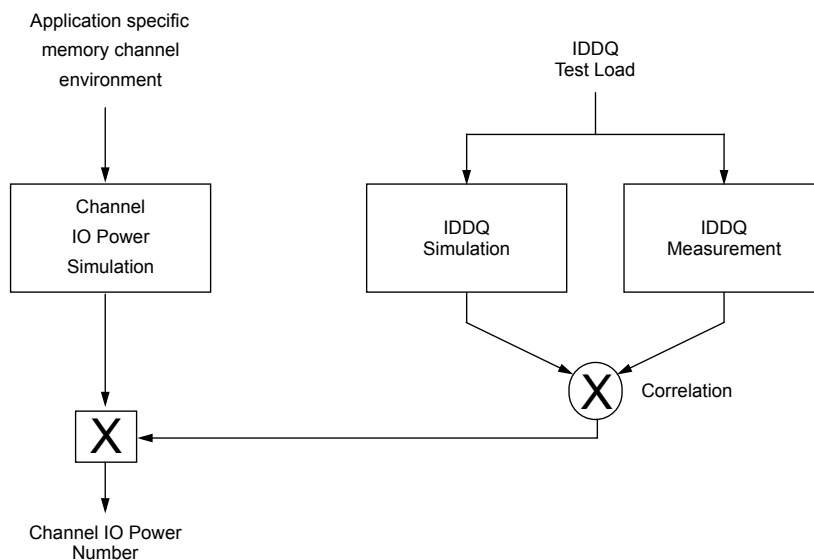

Figure 22. Correlation from simulated Channel IO Power to actual Channel IO Power supported by IDDQ Measurement.

[Table 36] Timings used for IDD, IPP and IDDQ Measurement-Loop Patterns

Symbol		DDR4-1600	DDR4-1866	DDR4-2133	DDR4-2400	DDR4-2666	Unit
		11-11-11	13-13-13	15-15-15	17-17-17	19-19-19	
tCK		1.25	1.071	0.937	0.833	0.75	ns
CL		11	13	15	17	19	nCK
CWL		11	12	14	16	18	nCK
nRCD		11	13	15	17	19	nCK
nRC		39	45	51	56	62	nCK
nRAS		28	32	36	39	43	nCK
nRP		11	13	15	17	19	nCK
nFAW	x4	16	16	16	16	16	nCK
	x8	20	22	23	26	28	nCK
nRRDS	x4	4	4	4	4	4	nCK
	x8	4	4	4	4	4	nCK
nRRDL	x4	5	5	6	6	7	nCK
	x8	5	5	6	6	7	nCK
tCCD_S		4	4	4	4	4	nCK
tCCD_L		5	5	6	6	7	nCK
tWTR_S		2	3	3	3	4	nCK
tWTR_L		6	7	8	9	10	nCK
nRFC 2Gb		128	150	171	193	214	nCK
nRFC 4Gb		208	243	278	313	347	nCK
nRFC 8Gb		280	327	374	421	467	nCK
nRFC 16Gb		440	514	587	661	734	nCK

[Table 37] Basic IDD, IPP and IDDQ Measurement Conditions

Symbol	Description
IDD0	Operating One Bank Active-Precharge Current (AL=0) CKE: High; External clock: On; tCK, nRC, nRAS, CL: see Table 36; BL: 8 ¹⁾ ; AL: 0; CS_n: High between ACT and PRE; Command, Address, Bank Group Address, Bank Address Inputs: partially toggling according to Table 38; Data IO: VDDQ; DM_n: stable at 1; Bank Activity: Cycling with one bank active at a time: 0,0,1,1,2,2,... (see Table 38); Output Buffer and RTT: Enabled in Mode Registers ²⁾ ; ODT Signal: stable at 0; Pattern Details: see Table 38
IDD0A	Operating One Bank Active-Precharge Current (AL=CL-1) AL = CL-1, Other conditions: see IDD0
IPP0	Operating One Bank Active-Precharge IPP Current Same condition with IDD0
IDD1	Operating One Bank Active-Read-Precharge Current (AL=0) CKE: High; External clock: On; tCK, nRC, nRAS, nRCD, CL: see Table 36; BL: 8 ¹⁾ ; AL: 0; CS_n: High between ACT, RD and PRE; Command, Address, Bank Group Address, Bank Address Inputs, Data IO: partially toggling according to Table 39; DM_n: stable at 1; Bank Activity: Cycling with one bank active at a time: 0,0,1,1,2,2,... (see Table 39); Output Buffer and RTT: Enabled in Mode Registers ²⁾ ; ODT Signal: stable at 0; Pattern Details: see Table 39
IDD1A	Operating One Bank Active-Read-Precharge Current (AL=CL-1) AL = CL-1, Other conditions: see IDD1
IPP1	Operating One Bank Active-Read-Precharge IPP Current Same condition with IDD1
IDD2N	Precharge Standby Current (AL=0) CKE: High; External clock: On; tCK, CL: see Table 36; BL: 8 ¹⁾ ; AL: 0; CS_n: stable at 1; Command, Address, Bank Group Address, Bank Address Inputs: partially toggling according to Table 40; Data IO: VDDQ; DM_n: stable at 1; Bank Activity: all banks closed; Output Buffer and RTT: Enabled in Mode Registers ²⁾ ; ODT Signal: stable at 0; Pattern Details: see Table 40
IDD2NA	Precharge Standby Current (AL=CL-1) AL = CL-1, Other conditions: see IDD2N
IPP2N	Precharge Standby IPP Current Same condition with IDD2N
IDD2NT	Precharge Standby ODT Current CKE: High; External clock: On; tCK, CL: see Table 36; BL: 8 ¹⁾ ; AL: 0; CS_n: stable at 1; Command, Address, Bank Group Address, Bank Address Inputs: partially toggling according to Table 41; Data IO: VSSQ; DM_n: stable at 1; Bank Activity: all banks closed; Output Buffer and RTT: Enabled in Mode Registers ²⁾ ; ODT Signal: toggling according to Table 41; Pattern Details: see Table 41
IDDQ2NT (Optional)	Precharge Standby ODT IDDQ Current Same definition like for IDD2NT, however measuring IDDQ current instead of IDD current
IDD2NL	Precharge Standby Current with CAL enabled Same definition like for IDD2N, CAL enabled ³⁾
IDD2NG	Precharge Standby Current with Gear Down mode enabled Same definition like for IDD2N, Gear Down mode enabled ^{3),5)}
IDD2ND	Precharge Standby Current with DLL disabled Same definition like for IDD2N, DLL disabled ³⁾
IDD2N_par	Precharge Standby Current with CA parity enabled Same definition like for IDD2N, CA parity enabled ³⁾
IDD2P	Precharge Power-Down Current CKE: Low; External clock: On; tCK, CL: see Table 36; BL: 8 ¹⁾ ; AL: 0; CS_n: stable at 1; Command, Address, Bank Group Address, Bank Address Inputs: stable at 0; Data IO: VDDQ; DM_n: stable at 1; Bank Activity: all banks closed; Output Buffer and RTT: Enabled in Mode Registers ²⁾ ; ODT Signal: stable at 0
IPP2P	Precharge Power-Down IPP Current Same condition with IDD2P
IDD2Q	Precharge Quiet Standby Current CKE: High; External clock: On; tCK, CL: see Table 36; BL: 8 ¹⁾ ; AL: 0; CS_n: stable at 1; Command, Address, Bank Group Address, Bank Address Inputs: stable at 0; Data IO: VDDQ; DM_n: stable at 1; Bank Activity: all banks closed; Output Buffer and RTT: Enabled in Mode Registers ²⁾ ; ODT Signal: stable at 0
IDD3N	Active Standby Current CKE: High; External clock: On; tCK, CL: see Table 36; BL: 8 ¹⁾ ; AL: 0; CS_n: stable at 1; Command, Address, Bank Group Address, Bank Address Inputs: partially toggling according to Table 40; Data IO: VDDQ; DM_n: stable at 1; Bank Activity: all banks open; Output Buffer and RTT: Enabled in Mode Registers ²⁾ ; ODT Signal: stable at 0; Pattern Details: see Table 40

[Table 37] Basic IDD, IPP and IDDQ Measurement Conditions

Symbol	Description
IDD3NA	Active Standby Current (AL=CL-1) AL = CL-1, Other conditions: see IDD3N
IPP3N	Active Standby IPP Current Same condition with IDD3N
IDD3P	Active Power-Down Current CKE: Low; External clock: On; tCK, CL: see Table 36; BL: 8 ¹ ; AL: 0; CS_n: stable at 1; Command, Address, Bank Group Address, Bank Address Inputs: stable at 0; Data IO: VDDQ; DM_n: stable at 1; Bank Activity: all banks open; Output Buffer and RTT: Enabled in Mode Registers ² ; ODT Signal: stable at 0
IPP3P	Active Power-Down IPP Current Same condition with IDD3P
IDD4R	Operating Burst Read Current CKE: High; External clock: On; tCK, CL: see Table 36; BL: 8 ² ; AL: 0; CS_n: High between RD; Command, Address, Bank Group Address, Bank Address Inputs: partially toggling according to Table 42; Data IO: seamless read data burst with different data between one burst and the next one according to Table 42; DM_n: stable at 1; Bank Activity: all banks open, RD commands cycling through banks: 0,0,1,1,2,2,... (see Table 42); Output Buffer and RTT: Enabled in Mode Registers ² ; ODT Signal: stable at 0; Pattern Details: see Table 42
IDD4RA	Operating Burst Read Current (AL=CL-1) AL = CL-1, Other conditions: see IDD4R
IDD4RB	Operating Burst Read Current with Read DBI Read DBI enabled ³ , Other conditions: see IDD4R
IPP4R	Operating Burst Read IPP Current Same condition with IDD4R
IDDQ4R (Optional)	Operating Burst Read IDDQ Current Same definition like for IDD4R, however measuring IDDQ current instead of IDD current
IDDQ4RB (Optional)	Operating Burst Read IDDQ Current with Read DBI Same definition like for IDD4RB, however measuring IDDQ current instead of IDD current
IDD4W	Operating Burst Write Current CKE: High; External clock: On; tCK, CL: see Table 36; BL: 8 ¹ ; AL: 0; CS_n: High between WR; Command, Address, Bank Group Address, Bank Address Inputs: partially toggling according to Table 43; Data IO: seamless write data burst with different data between one burst and the next one according to Table 43; DM_n: stable at 1; Bank Activity: all banks open, WR commands cycling through banks: 0,0,1,1,2,2,... (see Table 43); Output Buffer and RTT: Enabled in Mode Registers ² ; ODT Signal: stable at HIGH; Pattern Details: see Table 43
IDD4WA	Operating Burst Write Current (AL=CL-1) AL = CL-1, Other conditions: see IDD4W
IDD4WB	Operating Burst Write Current with Write DBI Write DBI enabled ³ , Other conditions: see IDD4W
IDD4WC	Operating Burst Write Current with Write CRC Write CRC enabled ³ , Other conditions: see IDD4W
IDD4W_par	Operating Burst Write Current with CA Parity CA Parity enabled ³ , Other conditions: see IDD4W
IPP4W	Operating Burst Write IPP Current Same condition with IDD4W
IDD5B	Burst Refresh Current (1X REF) CKE: High; External clock: On; tCK, CL, nRFC: see Table 36; BL: 8 ¹ ; AL: 0; CS_n: High between REF; Command, Address, Bank Group Address, Bank Address Inputs: partially toggling according to Table 45; Data IO: VDDQ; DM_n: stable at 1; Bank Activity: REF command every nRFC (see Table 45); Output Buffer and RTT: Enabled in Mode Registers ² ; ODT Signal: stable at 0; Pattern Details: see Table 45
IPP5B	Burst Refresh Write IPP Current (1X REF) Same condition with IDD5B
IDD5F2	Burst Refresh Current (2X REF) tRFC=tRFC_x2, Other conditions: see IDD5B
IPP5F2	Burst Refresh Write IPP Current (2X REF) Same condition with IDD5F2
IDD5F4	Burst Refresh Current (4X REF) tRFC=tRFC_x4, Other conditions: see IDD5B
IPP5F4	Burst Refresh Write IPP Current (4X REF) Same condition with IDD5F4

[Table 38] IDD0, IDD0A and IPP0 Measurement-Loop Pattern ¹⁾

CK_t/CK_c	CKE	Sub-Loop	Cycle Number	Command	CS_n	ACT_n	RAS_n/A16	CAS_n/A15	WE_n/A14	ODT	C[2:0] ³⁾	BG[1:0] ²⁾	BA[1:0]	A12/BC_n	A[17,13,11]	A[10]/AP	A[9:7]	A[6:3]	A[2:0]	Data ⁴⁾				
toggling Static High		0	0	ACT	0	0	0	0	0	0	0	0	0	0	0	0	0	0	0	0	-			
			1,2	D, D	1	0	0	0	0	0	0	0	0	0	0	0	0	0	0	0	0	0	-	
			3,4	D_#, D_#	1	1	1	1	1	1	0	0	3 ²⁾	3	0	0	0	7	F	0	0	0	-	
			...	repeat pattern 1...4 until nRAS - 1, truncate if necessary																				
			nRAS	PRE	0	1	0	1	0	0	0	0	0	0	0	0	0	0	0	0	0	0	0	-
			...	repeat pattern 1...4 until nRC - 1, truncate if necessary																				
		1	1*nRC	repeat Sub-Loop 0, use BG[1:0]²⁾ = 1, BA[1:0] = 1 instead																				
		2	2*nRC	repeat Sub-Loop 0, use BG[1:0]²⁾ = 0, BA[1:0] = 2 instead																				
		3	3*nRC	repeat Sub-Loop 0, use BG[1:0]²⁾ = 1, BA[1:0] = 3 instead																				
		4	4*nRC	repeat Sub-Loop 0, use BG[1:0]²⁾ = 0, BA[1:0] = 1 instead																				
		5	5*nRC	repeat Sub-Loop 0, use BG[1:0]²⁾ = 1, BA[1:0] = 2 instead																				
		6	6*nRC	repeat Sub-Loop 0, use BG[1:0]²⁾ = 0, BA[1:0] = 3 instead																				
		7	7*nRC	repeat Sub-Loop 0, use BG[1:0]²⁾ = 1, BA[1:0] = 0 instead																				
		8	8*nRC	repeat Sub-Loop 0, use BG[1:0]²⁾ = 2, BA[1:0] = 0 instead																				
		9	9*nRC	repeat Sub-Loop 0, use BG[1:0]²⁾ = 3, BA[1:0] = 1 instead																				
10	10*nRC	repeat Sub-Loop 0, use BG[1:0]²⁾ = 2, BA[1:0] = 2 instead																						
11	11*nRC	repeat Sub-Loop 0, use BG[1:0]²⁾ = 3, BA[1:0] = 3 instead																						
12	12*nRC	repeat Sub-Loop 0, use BG[1:0]²⁾ = 2, BA[1:0] = 1 instead																						
13	13*nRC	repeat Sub-Loop 0, use BG[1:0]²⁾ = 3, BA[1:0] = 2 instead																						
14	14*nRC	repeat Sub-Loop 0, use BG[1:0]²⁾ = 2, BA[1:0] = 3 instead																						
15	15*nRC	repeat Sub-Loop 0, use BG[1:0]²⁾ = 3, BA[1:0] = 0 instead																						

NOTE :
 1) DQS_t, DQS_c are VDDQ.
 2) BG1 is don't care for x16 device
 3) C[2:0] are used only for 3DS device
 4) DQ signals are VDDQ.

For x4 and x8 only

[Table 39] IDD1, IDD1A and IPP1 Measurement-Loop Pattern¹⁾

CK_t, CK_c	CKE	Sub-Loop	Cycle Number	Command	CS_n	ACT_n	RAS_n/A16	CAS_n/A15	WE_n/A14	ODT	C[2:0] ³⁾	BG[1:0] ²⁾	BA[1:0]	A12/BC_n	A[17,13,11]	A[10]/AP	A[9:7]	A[6:3]	A[2:0]	Data ⁴⁾			
toggling	Static High	0	0	ACT	0	0	0	0	0	0	0	0	0	0	0	0	0	0	0	0	-		
			1, 2	D, D	1	0	0	0	0	0	0	0	0	0	0	0	0	0	0	0	0	-	
			3, 4	D#, D#	1	1	1	1	1	1	0	0	3 ^{b)}	3	0	0	0	0	7	F	0	-	
			...	repeat pattern 1...4 until nRCD - AL - 1, truncate if necessary																			
			nRCD -AL	RD	0	1	1	0	1	0	0	0	0	0	0	0	0	0	0	0	0	0	D0=00, D1=FF D2=FF, D3=00 D4=FF, D5=00 D6=00, D7=FF
			...	repeat pattern 1...4 until nRAS - 1, truncate if necessary																			
			nRAS	PRE	0	1	0	1	0	0	0	0	0	0	0	0	0	0	0	0	0	0	-
			...	repeat pattern 1...4 until nRC - 1, truncate if necessary																			
		1	1*nRC + 0	ACT	0	0	0	1	1	0	0	1	1	0	0	0	0	0	0	0	0	-	
			1*nRC + 1, 2	D, D	1	0	0	0	0	0	0	0	0	0	0	0	0	0	0	0	0	-	
			1*nRC + 3, 4	D#, D#	1	1	1	1	1	1	0	0	3 ^{b)}	3	0	0	0	0	7	F	0	-	
			...	repeat pattern nRC + 1...4 until 1*nRC + nRAS - 1, truncate if necessary																			
			1*nRC + nRCD - AL	RD	0	1	1	0	1	0	0	0	1	1	0	0	0	0	0	0	0	0	D0=FF, D1=00 D2=00, D3=FF D4=00, D5=FF D6=FF, D7=00
			...	repeat pattern 1...4 until nRAS - 1, truncate if necessary																			
			1*nRC + nRAS	PRE	0	1	0	1	0	0	1	1	0	0	0	0	0	0	0	0	0	0	-
			...	repeat nRC + 1...4 until 2*nRC - 1, truncate if necessary																			
		2	2*nRC	repeat Sub-Loop 0, use BG[1:0] ²⁾ = 0, BA[1:0] = 2 instead																			
		3	3*nRC	repeat Sub-Loop 1, use BG[1:0] ²⁾ = 1, BA[1:0] = 3 instead																			
		4	4*nRC	repeat Sub-Loop 0, use BG[1:0] ²⁾ = 0, BA[1:0] = 1 instead																			
		5	5*nRC	repeat Sub-Loop 1, use BG[1:0] ²⁾ = 1, BA[1:0] = 2 instead																			
		6	6*nRC	repeat Sub-Loop 0, use BG[1:0] ²⁾ = 0, BA[1:0] = 3 instead																			
		8	7*nRC	repeat Sub-Loop 1, use BG[1:0] ²⁾ = 1, BA[1:0] = 0 instead																			
		9	9*nRC	repeat Sub-Loop 1, use BG[1:0] ²⁾ = 2, BA[1:0] = 0 instead																			
		10	10*nRC	repeat Sub-Loop 0, use BG[1:0] ²⁾ = 3, BA[1:0] = 1 instead																			
		11	11*nRC	repeat Sub-Loop 1, use BG[1:0] ²⁾ = 2, BA[1:0] = 2 instead																			
		12	12*nRC	repeat Sub-Loop 0, use BG[1:0] ²⁾ = 3, BA[1:0] = 3 instead																			
		13	13*nRC	repeat Sub-Loop 1, use BG[1:0] ²⁾ = 2, BA[1:0] = 1 instead																			
		14	14*nRC	repeat Sub-Loop 0, use BG[1:0] ²⁾ = 3, BA[1:0] = 2 instead																			
15	15*nRC	repeat Sub-Loop 1, use BG[1:0] ²⁾ = 2, BA[1:0] = 3 instead																					
16	16*nRC	repeat Sub-Loop 0, use BG[1:0] ²⁾ = 3, BA[1:0] = 0 instead																					

For x4 and x8 only

NOTE :
 1) DQS_t, DQS_c are used according to RD Commands, otherwise VDDQ.
 2) BG1 is don't care for x16 device.
 3) C[2:0] are used only for 3DS device.
 4) Burst Sequence driven on each DQ signal by Read Command. Outside burst operation, DQ signals are VDDQ.

[Table 40] IDD2N, IDD2NA, IDD2NL, IDD2NG, IDD2ND, IDD2N_par, IPP2,IDD3N, IDD3NA and IDD3P Measurement-Loop Pattern¹⁾

CK_t, CK_c	CKE	Sub-Loop	Cycle Number	Command	CS_n	ACT_n	RAS_n/A16	CAS_n/A15	WE_n/A14	ODT	C[2:0] ³⁾	BG[1:0] ²⁾	BA[1:0]	A12/BC_n	A[17,13,11]	A[10]/AP	A[9:7]	A[6:3]	A[2:0]	Data ⁴⁾		
toggling	Static High	0	0	D, D	1	0	0	0	0	0	0	0	0	0	0	0	0	0	0	0	0	
			1	D, D	1	0	0	0	0	0	0	0	0	0	0	0	0	0	0	0	0	0
			2	D#, D#	1	1	1	1	1	1	0	0	3 ²⁾	3	0	0	0	7	F	0	0	0
			3	D#, D#	1	1	1	1	1	1	0	0	3 ²⁾	3	0	0	0	7	F	0	0	0
		1	4-7	repeat Sub-Loop 0, use BG[1:0]²⁾ = 1, BA[1:0] = 1 instead																		
		2	8-11	repeat Sub-Loop 0, use BG[1:0]²⁾ = 0, BA[1:0] = 2 instead																		
		3	12-15	repeat Sub-Loop 0, use BG[1:0]²⁾ = 1, BA[1:0] = 3 instead																		
		4	16-19	repeat Sub-Loop 0, use BG[1:0]²⁾ = 0, BA[1:0] = 1 instead																		
		5	20-23	repeat Sub-Loop 0, use BG[1:0]²⁾ = 1, BA[1:0] = 2 instead																		
		6	24-27	repeat Sub-Loop 0, use BG[1:0]²⁾ = 0, BA[1:0] = 3 instead																		
		7	28-31	repeat Sub-Loop 0, use BG[1:0]²⁾ = 1, BA[1:0] = 0 instead																		
		8	32-35	repeat Sub-Loop 0, use BG[1:0]²⁾ = 2, BA[1:0] = 0 instead																		
		9	36-39	repeat Sub-Loop 0, use BG[1:0]²⁾ = 3, BA[1:0] = 1 instead																		
		10	40-43	repeat Sub-Loop 0, use BG[1:0]²⁾ = 2, BA[1:0] = 2 instead																		
		11	44-47	repeat Sub-Loop 0, use BG[1:0]²⁾ = 3, BA[1:0] = 3 instead																		
		12	48-51	repeat Sub-Loop 0, use BG[1:0]²⁾ = 2, BA[1:0] = 1 instead																		
13	52-55	repeat Sub-Loop 0, use BG[1:0]²⁾ = 3, BA[1:0] = 2 instead																				
14	56-59	repeat Sub-Loop 0, use BG[1:0]²⁾ = 2, BA[1:0] = 3 instead																				
15	60-63	repeat Sub-Loop 0, use BG[1:0]²⁾ = 3, BA[1:0] = 0 instead																				

- NOTE :**
 1) DQS_t, DQS_c are VDDQ.
 2) BG1 is don't care for x16 device.
 3) C[2:0] are used only for 3DS device.
 4) DQ signals are VDDQ.

[Table 41] IDD2NT and IDDQ2NT Measurement-Loop Pattern¹⁾

CK _t , CK _c	CKE	Sub-Loop	Cycle Number	Command	CS _n	ACT _n	RAS _n /A16	CAS _n /A15	WE _n /A14	ODT	C[2:0] ³⁾	BG[1:0] ²⁾	BA[1:0]	A12/BC _n	A[17,13,11]	A[10]/AP	A[9:7]	A[6:3]	A[2:0]	Data ⁴⁾		
toggling	Static High	0	0	D, D	1	0	0	0	0	0	0	0	0	0	0	0	0	0	0	0	-	
			1	D, D	1	0	0	0	0	0	0	0	0	0	0	0	0	0	0	0	0	-
			2	D#, D#	1	1	1	1	1	1	0	0	3 ²⁾	3	0	0	0	0	7	F	0	-
			3	D#, D#	1	1	1	1	1	1	0	0	3 ²⁾	3	0	0	0	0	7	F	0	-
		1	4-7	repeat Sub-Loop 0, but ODT = 1 and BG[1:0] ²⁾ = 1, BA[1:0] = 1 instead																		
		2	8-11	repeat Sub-Loop 0, but ODT = 0 and BG[1:0] ²⁾ = 0, BA[1:0] = 2 instead																		
		3	12-15	repeat Sub-Loop 0, but ODT = 1 and BG[1:0] ²⁾ = 1, BA[1:0] = 3 instead																		
		4	16-19	repeat Sub-Loop 0, but ODT = 0 and BG[1:0] ²⁾ = 0, BA[1:0] = 1 instead																		
		5	20-23	repeat Sub-Loop 0, but ODT = 1 and BG[1:0] ²⁾ = 1, BA[1:0] = 2 instead																		
		6	24-27	repeat Sub-Loop 0, but ODT = 0 and BG[1:0] ²⁾ = 0, BA[1:0] = 3 instead																		
		7	28-31	repeat Sub-Loop 0, but ODT = 1 and BG[1:0] ²⁾ = 1, BA[1:0] = 0 instead																		
		8	32-35	repeat Sub-Loop 0, but ODT = 0 and BG[1:0] ²⁾ = 2, BA[1:0] = 0 instead																		
		9	36-39	repeat Sub-Loop 0, but ODT = 1 and BG[1:0] ²⁾ = 3, BA[1:0] = 1 instead																		
		10	40-43	repeat Sub-Loop 0, but ODT = 0 and BG[1:0] ²⁾ = 2, BA[1:0] = 2 instead																		
		11	44-47	repeat Sub-Loop 0, but ODT = 1 and BG[1:0] ²⁾ = 3, BA[1:0] = 3 instead																		
12	48-51	repeat Sub-Loop 0, but ODT = 0 and BG[1:0] ²⁾ = 2, BA[1:0] = 1 instead																				
13	52-55	repeat Sub-Loop 0, but ODT = 1 and BG[1:0] ²⁾ = 3, BA[1:0] = 2 instead																				
14	56-59	repeat Sub-Loop 0, but ODT = 0 and BG[1:0] ²⁾ = 2, BA[1:0] = 3 instead																				
15	60-63	repeat Sub-Loop 0, but ODT = 1 and BG[1:0] ²⁾ = 3, BA[1:0] = 0 instead																				

For x4 and x8 only

- NOTE :
- 1) DQS_t, DQS_c are VDDQ.
 - 2) BG1 is don't care for x16 device.
 - 3) C[2:0] are used only for 3DS device.
 - 4) DQ signals are VDDQ.

[Table 42] IDD4R, IDDR4RA, IDD4RB and IDDQ4R Measurement-Loop Pattern¹⁾

CK_t, CK_c	CKE	Sub-Loop	Cycle Number	Command	CS_n	ACT_n	RAS_n/A16	CAS_n/A15	WE_n/A14	ODT	C[2:0] ³⁾	BG[1:0] ²⁾	BA[1:0]	A12/BC_n	A[17,13,11]	A[10]/AP	A[9:7]	A[6:3]	A[2:0]	Data ⁴⁾			
toggling	Static High	0	0	RD	0	1	1	0	1	0	0	0	0	0	0	0	0	0	0	0	D0=00, D1=FF D2=FF, D3=00 D4=FF, D5=00 D6=00, D7=FF		
			1	D	1	0	0	0	0	0	0	0	0	0	0	0	0	0	0	0	0	-	
			2,3	D#, D#	1	1	1	1	1	1	0	0	3 ²⁾	3	0	0	0	0	7	F	0	-	
		1	4	RD	0	1	1	0	1	0	0	0	0	1	1	0	0	0	7	F	0	D0=FF, D1=00 D2=00, D3=FF D4=00, D5=FF D6=FF, D7=00	
			5	D	1	0	0	0	0	0	0	0	0	0	0	0	0	0	0	0	0	0	-
			6,7	D#, D#	1	1	1	1	1	1	0	0	3 ²⁾	3	0	0	0	0	7	F	0	-	
		2	8-11	repeat Sub-Loop 0, use BG[1:0]²⁾ = 0, BA[1:0] = 2 instead																			
		3	12-15	repeat Sub-Loop 1, use BG[1:0]²⁾ = 1, BA[1:0] = 3 instead																			
		4	16-19	repeat Sub-Loop 0, use BG[1:0]²⁾ = 0, BA[1:0] = 1 instead																			
		5	20-23	repeat Sub-Loop 1, use BG[1:0]²⁾ = 1, BA[1:0] = 2 instead																			
		6	24-27	repeat Sub-Loop 0, use BG[1:0]²⁾ = 0, BA[1:0] = 3 instead																			
		7	28-31	repeat Sub-Loop 1, use BG[1:0]²⁾ = 1, BA[1:0] = 0 instead																			
		8	32-35	repeat Sub-Loop 0, use BG[1:0]²⁾ = 2, BA[1:0] = 0 instead																			
		9	36-39	repeat Sub-Loop 1, use BG[1:0]²⁾ = 3, BA[1:0] = 1 instead																			
		10	40-43	repeat Sub-Loop 0, use BG[1:0]²⁾ = 2, BA[1:0] = 2 instead																			
		11	44-47	repeat Sub-Loop 1, use BG[1:0]²⁾ = 3, BA[1:0] = 3 instead																			
12	48-51	repeat Sub-Loop 0, use BG[1:0]²⁾ = 2, BA[1:0] = 1 instead																					
13	52-55	repeat Sub-Loop 1, use BG[1:0]²⁾ = 3, BA[1:0] = 2 instead																					
14	56-59	repeat Sub-Loop 0, use BG[1:0]²⁾ = 2, BA[1:0] = 3 instead																					
15	60-63	repeat Sub-Loop 1, use BG[1:0]²⁾ = 3, BA[1:0] = 0 instead																					
																				For x4 and x8 only			

NOTE :
 1) DQS_t, DQS_c are used according to RD Commands, otherwise VDDQ.
 2) BG1 is don't care for x16 device.
 3) C[2:0] are used only for 3DS device.
 4) Burst Sequence driven on each DQ signal by Read Command.

[Table 43] IDD4W, IDD4WA, IDD4WB and IDD4W_par Measurement-Loop Pattern¹⁾

CK_t, CK_c	CKE	Sub-Loop	Cycle Number	Command	CS_n	ACT_n	RAS_n/A16	CAS_n/A15	WE_n/A14	ODT	C[2:0] ³⁾	BG[1:0] ²⁾	BA[1:0]	A12/BC_n	A[17,13,11]	A[10]/AP	A[9:7]	A[6:3]	A[2:0]	Data ⁴⁾			
toggling	Static High	0	0	WR	0	1	1	0	0	1	0	0	0	0	0	0	0	0	0	0	D0=00, D1=FF D2=FF, D3=00 D4=FF, D5=00 D6=00, D7=FF		
			1	D	1	0	0	0	0	0	1	0	0	0	0	0	0	0	0	0	0	-	
			2,3	D#, D#	1	1	1	1	1	1	1	0	3 ²⁾	3	0	0	0	0	7	F	0	-	
		1	4	WR	0	1	1	0	0	0	1	0	0	1	1	0	0	0	7	F	0	D0=FF, D1=00 D2=00, D3=FF D4=00, D5=FF D6=FF, D7=00	
			5	D	1	0	0	0	0	0	0	1	0	0	0	0	0	0	0	0	0	0	-
			6,7	D#, D#	1	1	1	1	1	1	1	0	3 ²⁾	3	0	0	0	0	7	F	0	-	
		2	8-11	repeat Sub-Loop 0, use BG[1:0]²⁾ = 0, BA[1:0] = 2 instead																			
		3	12-15	repeat Sub-Loop 1, use BG[1:0]²⁾ = 1, BA[1:0] = 3 instead																			
		4	16-19	repeat Sub-Loop 0, use BG[1:0]²⁾ = 0, BA[1:0] = 1 instead																			
		5	20-23	repeat Sub-Loop 1, use BG[1:0]²⁾ = 1, BA[1:0] = 2 instead																			
		6	24-27	repeat Sub-Loop 0, use BG[1:0]²⁾ = 0, BA[1:0] = 3 instead																			
		7	28-31	repeat Sub-Loop 1, use BG[1:0]²⁾ = 1, BA[1:0] = 0 instead																			
		8	32-35	repeat Sub-Loop 0, use BG[1:0]²⁾ = 2, BA[1:0] = 0 instead																			
		9	36-39	repeat Sub-Loop 1, use BG[1:0]²⁾ = 3, BA[1:0] = 1 instead																			
		10	40-43	repeat Sub-Loop 0, use BG[1:0]²⁾ = 2, BA[1:0] = 2 instead																			
11	44-47	repeat Sub-Loop 1, use BG[1:0]²⁾ = 3, BA[1:0] = 3 instead																					
12	48-51	repeat Sub-Loop 0, use BG[1:0]²⁾ = 2, BA[1:0] = 1 instead																					
13	52-55	repeat Sub-Loop 1, use BG[1:0]²⁾ = 3, BA[1:0] = 2 instead																					
14	56-59	repeat Sub-Loop 0, use BG[1:0]²⁾ = 2, BA[1:0] = 3 instead																					
15	60-63	repeat Sub-Loop 1, use BG[1:0]²⁾ = 3, BA[1:0] = 0 instead																					
For x4 and x8 only																							

NOTE :
 1) DQS_t, DQS_c are used according to WR Commands, otherwise VDDQ.
 2) BG1 is don't care for x16 device.
 3) C[2:0] are used only for 3DS device.
 4) Burst Sequence driven on each DQ signal by Write Command.

[Table 44] IDD4WC Measurement-Loop Pattern¹⁾

CK_t, CK_c	CKE	Sub-Loop	Cycle Number	Command	CS_n	ACT_n	RAS_n/A16	CAS_n/A15	WE_n/A14	ODT	C[2:0] ³⁾	BG[1:0] ²⁾	BA[1:0]	A12/BC_n	A[17,13,11]	A[10]/AP	A[9:7]	A[6:3]	A[2:0]	Data ⁴⁾		
toggling	Static High	0	0	WR	0	1	1	0	0	1	0	0	0	0	0	0	0	0	0	0	D0=00, D1=FF D2=FF, D3=00 D4=FF, D5=00 D6=00, D7=FF D8=CRC	
			1,2	D, D	1	0	0	0	0	1	0	0	0	0	0	0	0	0	0	0	0	-
			3,4	D#, D#	1	1	1	1	1	1	0	3 ²⁾	3	0	0	0	0	7	F	0	-	
			5	WR	0	1	1	0	0	1	0	1	1	0	0	0	7	F	0	D0=FF, D1=00 D2=00, D3=FF D4=00, D5=FF D6=FF, D7=00 D8=CRC		
			6,7	D, D	1	0	0	0	0	1	0	0	0	0	0	0	0	0	0	0	-	
			8,9	D#, D#	1	1	1	1	1	1	0	3 ²⁾	3	0	0	0	7	F	0	-		
		2	10-14	repeat Sub-Loop 0, use BG[1:0]²⁾ = 0, BA[1:0] = 2 instead																		
		3	15-19	repeat Sub-Loop 1, use BG[1:0]²⁾ = 1, BA[1:0] = 3 instead																		
		4	20-24	repeat Sub-Loop 0, use BG[1:0]²⁾ = 0, BA[1:0] = 1 instead																		
		5	25-29	repeat Sub-Loop 1, use BG[1:0]²⁾ = 1, BA[1:0] = 2 instead																		
		6	30-34	repeat Sub-Loop 0, use BG[1:0]²⁾ = 0, BA[1:0] = 3 instead																		
		7	35-39	repeat Sub-Loop 1, use BG[1:0]²⁾ = 1, BA[1:0] = 0 instead																		
		8	40-44	repeat Sub-Loop 0, use BG[1:0]²⁾ = 2, BA[1:0] = 0 instead																		
		9	45-49	repeat Sub-Loop 1, use BG[1:0]²⁾ = 3, BA[1:0] = 1 instead																		
		10	50-54	repeat Sub-Loop 0, use BG[1:0]²⁾ = 2, BA[1:0] = 2 instead																		
11	55-59	repeat Sub-Loop 1, use BG[1:0]²⁾ = 3, BA[1:0] = 3 instead																				
12	60-64	repeat Sub-Loop 0, use BG[1:0]²⁾ = 2, BA[1:0] = 1 instead																				
13	65-69	repeat Sub-Loop 1, use BG[1:0]²⁾ = 3, BA[1:0] = 2 instead																				
14	70-74	repeat Sub-Loop 0, use BG[1:0]²⁾ = 2, BA[1:0] = 3 instead																				
15	75-79	repeat Sub-Loop 1, use BG[1:0]²⁾ = 3, BA[1:0] = 0 instead																				

NOTE :
 1) DQS_t, DQS_c are VDDQ.
 2) BG1 is don't care for x16 device.
 3) C[2:0] are used only for 3DS device.
 4) Burst Sequence driven on each DQ signal by Write Command.

For x4 and x8 only

[Table 45] IDD5B Measurement-Loop Pattern¹⁾

CK _t , CK _c	CKE	Sub-Loop	Cycle Number	Command	CS _n	ACT _n	RAS _n /A16	CAS _n /A15	WE _n /A14	ODT	C[2:0] ³⁾	BG[1:0] ²⁾	BA[1:0]	A12/BC _n	A[17,13,11]	A[10]/AP	A[9:7]	A[6:3]	A[2:0]	Data ⁴⁾			
toggling	Static High	0	0	REF	1	0	0	0	0	0	0	0	0	0	0	0	0	0	0	0	-		
		1	1	D	1	0	0	0	0	0	0	0	0	0	0	0	0	0	0	0	0	-	
		2	2	D	1	0	0	0	0	0	0	0	0	0	0	0	0	0	0	0	0	0	-
		3	3	D#, D#	1	1	1	1	1	1	0	0	3 ²⁾	3	0	0	0	7	F	0	0	-	
		4	4	D#, D#	1	1	1	1	1	1	0	0	3 ²⁾	3	0	0	0	7	F	0	0	-	
		4-7	repeat pattern 1...4, use BG[1:0] ²⁾ = 1, BA[1:0] = 1 instead																				
		8-11	repeat pattern 1...4, use BG[1:0] ²⁾ = 0, BA[1:0] = 2 instead																				
		12-15	repeat pattern 1...4, use BG[1:0] ²⁾ = 1, BA[1:0] = 3 instead																				
		16-19	repeat pattern 1...4, use BG[1:0] ²⁾ = 0, BA[1:0] = 1 instead																				
		20-23	repeat pattern 1...4, use BG[1:0] ²⁾ = 1, BA[1:0] = 2 instead																				
		24-27	repeat pattern 1...4, use BG[1:0] ²⁾ = 0, BA[1:0] = 3 instead																				
		28-31	repeat pattern 1...4, use BG[1:0] ²⁾ = 1, BA[1:0] = 0 instead																				
		32-35	repeat pattern 1...4, use BG[1:0] ²⁾ = 2, BA[1:0] = 0 instead																				
		36-39	repeat pattern 1...4, use BG[1:0] ²⁾ = 3, BA[1:0] = 1 instead																				
		40-43	repeat pattern 1...4, use BG[1:0] ²⁾ = 2, BA[1:0] = 2 instead																				
		44-47	repeat pattern 1...4, use BG[1:0] ²⁾ = 3, BA[1:0] = 3 instead																				
		48-51	repeat pattern 1...4, use BG[1:0] ²⁾ = 2, BA[1:0] = 1 instead																				
		52-55	repeat pattern 1...4, use BG[1:0] ²⁾ = 3, BA[1:0] = 2 instead																				
		56-59	repeat pattern 1...4, use BG[1:0] ²⁾ = 2, BA[1:0] = 3 instead																				
		60-63	repeat pattern 1...4, use BG[1:0] ²⁾ = 3, BA[1:0] = 0 instead																				
		2	64 ... nRFC - 1	repeat Sub-Loop 1, Truncate, if necessary																			

For x4 and x8 only

- NOTE :
- 1) DQS_t, DQS_c are VDDQ.
 - 2) BG1 is don't care for x16 device.
 - 3) C[2:0] are used only for 3DS device.
 - 4) DQ signals are VDDQ.

[Table 46] IDD7 Measurement-Loop Pattern¹⁾

CK_t, CK_c	CKE	Sub-Loop	Cycle Number	Command	CS_n	ACT_n	RAS_n/A16	CAS_n/A15	WE_n/A14	ODT	C[2:0] ³⁾	BG[1:0] ²⁾	BA[1:0]	A12/BC_n	A[17,13,11]	A[10]/AP	A[9:7]	A[6:3]	A[2:0]	Data ⁴⁾			
toggling	Static High	0	0	ACT	0	0	0	0	0	0	0	0	0	0	0	0	0	0	0	0	-		
			1	RDA	0	1	1	0	1	0			0	0	0	0	1	0	0	0	0	D0=00, D1=FF D2=FF, D3=00 D4=FF, D5=00 D6=00, D7=FF	
			2	D	1	0	0	0	0	0	0	0	0	0	0	0	0	0	0	0	0	0	-
			3	D#	1	1	1	1	1	1	0	0	0	3 ²⁾	3	0	0	0	7	F	0	0	-
			...	repeat pattern 2...3 until nRRD - 1, if nRRD > 4. Truncate if necessary																			
		1	nRRD	ACT	0	0	0	0	0	0	0	0	0	1	1	0	0	0	0	0	0	0	-
			nRRD + 1	RDA	0	1	1	0	1	0				1	1	0	0	1	0	0	0	0	D0=FF, D1=00 D2=00, D3=FF D4=00, D5=FF D6=FF, D7=00
		...	repeat pattern 2 ... 3 until 2*nRRD - 1, if nRRD > 4. Truncate if necessary																				
		2	2*nRRD	repeat Sub-Loop 0, use BG[1:0] ²⁾ = 0, BA[1:0] = 2 instead																			
		3	3*nRRD	repeat Sub-Loop 1, use BG[1:0] ²⁾ = 1, BA[1:0] = 3 instead																			
		4	4*nRRD	repeat pattern 2 ... 3 until nFAW - 1, if nFAW > 4*nRRD. Truncate if necessary																			
		5	nFAW	repeat Sub-Loop 0, use BG[1:0] ²⁾ = 0, BA[1:0] = 1 instead																			
		6	nFAW + nRRD	repeat Sub-Loop 1, use BG[1:0] ²⁾ = 1, BA[1:0] = 2 instead																			
		7	nFAW + 2*nRRD	repeat Sub-Loop 0, use BG[1:0] ²⁾ = 0, BA[1:0] = 3 instead																			
		8	nFAW + 3*nRRD	repeat Sub-Loop 1, use BG[1:0] ²⁾ = 1, BA[1:0] = 0 instead																			
		9	nFAW + 4*nRRD	repeat Sub-Loop 4																			
		10	2*nFAW	repeat Sub-Loop 0, use BG[1:0] ²⁾ = 2, BA[1:0] = 0 instead																			
		11	2*nFAW + nRRD	repeat Sub-Loop 1, use BG[1:0] ²⁾ = 3, BA[1:0] = 1 instead																			
		12	2*nFAW + 2*nRRD	repeat Sub-Loop 0, use BG[1:0] ²⁾ = 2, BA[1:0] = 2 instead																			
		13	2*nFAW + 3*nRRD	repeat Sub-Loop 1, use BG[1:0] ²⁾ = 3, BA[1:0] = 3 instead																			
14	2*nFAW + 4*nRRD	repeat Sub-Loop 4																					
15	3*nFAW	repeat Sub-Loop 0, use BG[1:0] ²⁾ = 2, BA[1:0] = 1 instead																					
16	3*nFAW + nRRD	repeat Sub-Loop 1, use BG[1:0] ²⁾ = 3, BA[1:0] = 2 instead																					
17	3*nFAW + 2*nRRD	repeat Sub-Loop 0, use BG[1:0] ²⁾ = 2, BA[1:0] = 3 instead																					
18	3*nFAW + 3*nRRD	repeat Sub-Loop 1, use BG[1:0] ²⁾ = 3, BA[1:0] = 0 instead																					
19	3*nFAW + 4*nRRD	repeat Sub-Loop 4																					
20	4*nFAW	repeat pattern 2 ... 3 until nRC - 1, if nRC > 4*nFAW. Truncate if necessary																					

For x4 and x8 only

NOTE:
 1) DQS_t, DQS_c are VDDQ.
 2) BG1 is don't care for x16 device.
 3) C[2:0] are used only for 3DS device.
 4) Burst Sequence driven on each DQ signal by Read Command. Outside burst operation, DQ signals are VDDQ.

14. IDD SPEC TABLE

IDD and IPP values are for typical operating range of voltage and temperature unless otherwise noted.

[Table 47] I_{DD} and I_{DDQ} Specification for M391A1K43BB1 and M391A1K43BB2

Symbol	M391A1K43BB1: 8GB(1Gx72) Module				M391A1K43BB2: 8GB(1Gx72) Module		Unit	NOTE
	DDR4-2133		DDR4-2400		DDR4-2666			
	15-15-15		17-17-17		19-19-19			
	VDD 1.2V	VPP 2.5V	VDD 1.2V	VPP 2.5V	VDD 1.2V	VPP 2.5V		
	IDD Max.	IPP Max.	IDD Max.	IPP Max.	IDD Max.	IPP Max.		
I_{DD0}	279	36	279	36	288	36	mA	
I_{DD0A}	288	36	306	36	315	36	mA	
I_{DD1}	396	36	405	36	405	36	mA	
I_{DD1A}	423	36	432	36	459	36	mA	
I_{DD2N}	198	27	207	27	207	27	mA	
I_{DD2NA}	225	27	234	27	234	27	mA	
I_{DD2NT}	225	27	234	27	234	27	mA	
I_{DD2NL}	135	27	153	27	153	27	mA	
I_{DD2NG}	198	27	207	27	207	27	mA	
I_{DD2ND}	180	27	189	27	189	27	mA	
I_{DD2N_par}	207	27	216	27	216	27	mA	
I_{DD2P}	144	27	144	27	144	27	mA	
I_{DD2Q}	180	27	189	27	189	27	mA	
I_{DD3N}	324	27	324	27	324	27	mA	
I_{DD3NA}	342	27	342	27	342	27	mA	
I_{DD3P}	189	27	198	27	198	27	mA	
I_{DD4R}	909	27	963	27	1116	27	mA	
I_{DD4RA}	945	27	999	27	1170	27	mA	
I_{DD4RB}	918	27	981	27	1125	27	mA	
I_{DD4W}	756	27	801	27	909	27	mA	
I_{DD4WA}	792	27	846	27	954	27	mA	
I_{DD4WB}	756	27	810	27	918	27	mA	
I_{DD4WC}	666	27	747	27	846	27	mA	
I_{DD4W_par}	828	27	891	27	1008	27	mA	
I_{DD5B}	1791	162	1791	162	1944	162	mA	
I_{DD5F2}	1242	135	1251	135	1350	135	mA	
I_{DD5F4}	1044	126	1053	126	1134	126	mA	
I_{DD6N}	207	36	207	36	216	36	mA	
I_{DD6E}	306	45	306	45	324	54	mA	
I_{DD6R}	144	32	144	32	144	36	mA	
I_{DD6A}	198	36	198	36	198	36	mA	
I_{DD7}	1278	72	1287	77	1395	81	mA	
I_{DD8}	99	27	99	27	99	27	mA	

NOTE :

- 1) DIMM IDD SPEC is based on the condition that de-activated rank(IDLE) is IDD2N. Please refer to Table 49.
- 2) IDD current measure method and detail patterns are described on DDR4 component datasheet.
- 3) VDD and VDDQ are merged on module PCB (IDDQ values are not considered by Qoff condition)
- 4) DIMM IDD Values are calculated based on the component IDD spec and Register power.

[Table 48] I_{DD} and I_{DDQ} Specification for M391A2K43BB1

Symbol	M391A2K43BB1: 16GB(2Gx72) Module						Unit	NOTE
	DDR4-2133		DDR4-2400		DDR4-2666			
	15-15-15		17-17-17		19-19-19			
	VDD 1.2V	VPP 2.5V	VDD 1.2V	VPP 2.5V	VDD 1.2V	VPP 2.5V		
	IDD Max.	IPP Max.	IDD Max.	IPP Max.	IDD Max.	IPP Max.		
I_{DD0}	477	63	486	63	495	63	mA	
I_{DD0A}	486	63	513	63	522	63	mA	
I_{DD1}	594	63	612	63	612	63	mA	
I_{DD1A}	621	63	639	63	666	63	mA	
I_{DD2N}	396	54	414	54	414	54	mA	
I_{DD2NA}	450	54	468	54	468	54	mA	
I_{DD2NT}	450	54	468	54	468	54	mA	
I_{DD2NL}	270	54	306	54	306	54	mA	
I_{DD2NG}	396	54	414	54	414	54	mA	
I_{DD2ND}	360	54	378	54	378	54	mA	
I_{DD2N_par}	414	54	432	54	432	54	mA	
I_{DD2P}	288	54	288	54	288	54	mA	
I_{DD2Q}	360	54	378	54	378	54	mA	
I_{DD3N}	648	54	648	54	648	54	mA	
I_{DD3NA}	684	54	684	54	684	54	mA	
I_{DD3P}	378	54	396	54	396	54	mA	
I_{DD4R}	1107	54	1170	54	1323	54	mA	
I_{DD4RA}	1143	54	1206	54	1377	54	mA	
I_{DD4RB}	1116	54	1188	54	1332	54	mA	
I_{DD4W}	954	54	1008	54	1116	54	mA	
I_{DD4WA}	990	54	1053	54	1161	54	mA	
I_{DD4WB}	954	54	1017	54	1125	54	mA	
I_{DD4WC}	864	54	954	54	1053	54	mA	
I_{DD4W_par}	1026	54	1098	54	1215	54	mA	
I_{DD5B}	1989	189	1998	189	2151	189	mA	
I_{DD5F2}	1440	162	1458	162	1557	162	mA	
I_{DD5F4}	1242	153	1260	153	1341	153	mA	
I_{DD6N}	414	72	414	72	432	72	mA	
I_{DD6E}	612	90	612	90	648	108	mA	
I_{DD6R}	288	63	288	63	288	72	mA	
I_{DD6A}	396	72	396	72	396	72	mA	
I_{DD7}	1476	99	1494	104	1602	108	mA	
I_{DD8}	198	54	198	54	198	54	mA	

NOTE :

- 1) DIMM IDD SPEC is based on the condition that de-activated rank(IDLE) is IDD2N. Please refer to Table 49.
- 2) IDD current measure method and detail patterns are described on DDR4 component datasheet.
- 3) VDD and VDDQ are merged on module PCB (IDDQ values are not considered by Qoff condition)
- 4) DIMM IDD Values are calculated based on the component IDD spec and Register power.

[Table 49] DIMM Rank Status

SEC DIMM	Operating Rank	The other Rank
I_{DD0}	I_{DD0}	I_{DD2N}
I_{DD1}	I_{DD1}	I_{DD2N}
I_{DD2P}	I_{DD2P}	I_{DD2P}
I_{DD2N}	I_{DD2N}	I_{DD2N}
I_{DD2Q}	I_{DD2Q}	I_{DD2Q}
I_{DD3P}	I_{DD3P}	I_{DD3P}
I_{DD3N}	I_{DD3N}	I_{DD3N}
I_{DD4R}	I_{DD4R}	I_{DD2N}
I_{DD4W}	I_{DD4W}	I_{DD2N}
I_{DD5B}	I_{DD5B}	I_{DD2N}
I_{DD6}	I_{DD6}	I_{DD6}
I_{DD7}	I_{DD7}	I_{DD2N}
I_{DD8}	I_{DD8}	I_{DD8}

15. INPUT/OUTPUT CAPACITANCE

[Table 50] Silicon Pad I/O Capacitance

Symbol	Parameter	DDR4-1600/1866/2133		DDR4-2400/2666		Unit	NOTE
		min	max	min	max		
C _{IO}	Input/output capacitance	0.55	1.4	0.55	1.15	pF	1,2,3
C _{DIO}	Input/output capacitance delta	-0.1	0.1	-0.1	0.1	pF	1,2,3,11
C _{DDQS}	Input/output capacitance delta DQS _t and DQS _c	-	0.05	-	0.05	pF	1,2,3,5
C _{CK}	Input capacitance, CK _t and CK _c	0.2	0.8	0.2	0.7	pF	1,3
C _{DCK}	Input capacitance delta CK _t and CK _c	-	0.05	-	0.05	pF	1,3,4
C _I	Input capacitance (CTRL, ADD, CMD pins only)	0.2	0.8	0.2	0.7	pF	1,3,6
C _{DI_CTRL}	Input capacitance delta (All CTRL pins only)	-0.1	0.1	-0.1	0.1	pF	1,3,7,8
C _{DI_ADD_CMD}	Input capacitance delta (All ADD/CMD pins only)	-0.1	0.1	-0.1	0.1	pF	1,2,9,10
C _{ALERT}	Input/output capacitance of ALERT	0.5	1.5	0.5	1.5	pF	1,3
C _{ZQ}	Input/output capacitance of ZQ	-	2.3	-	2.3	pF	1,3,12
C _{TEN}	Input capacitance of TEN	0.2	2.3	0.2	2.3	pF	1,3,13

NOTE :

- 1) This parameter is not subject to production test. It is verified by design and characterization. The silicon only capacitance is validated by de-embedding the package L & C parasitic. The capacitance is measured with VDD, VDDQ, VSS, VSSQ applied with all other signal pins floating. Measurement procedure tbd.
- 2) DQ, DM_n, DQS_T, DQS_c, TDQS_T, TDQS_C. Although the DM, TDQS_T and TDQS_C pins have different functions, the loading matches DQ and DQS
- 3) This parameter applies to monolithic devices only; stacked/dual-die devices are not covered here
- 4) Absolute value CK_T-CK_C
- 5) Absolute value of CIO(DQS_T)-CIO (DQS_c)
- 6) C_I applies to ODT, CS_n, CKE, A0-A17, BA0-BA1, BG0-BG1, RAS_n/A16, CAS_n/A15, WE_n/A14, ACT_n and PAR.
- 7) C_{DI_CTRL} applies to ODT, CS_n and CKE
- 8) $C_{DI_CTRL} = C_I(CTRL) - 0.5 * (C_I(CLK_T) + C_I(CLK_C))$
- 9) C_{DI_ADD_CMD} applies to, A0-A17, BA0-BA1, BG0-BG1, RAS_n/A16, CAS_n/A15, WE_n/A14, ACT_n and PAR.
- 10) $C_{DI_ADD_CMD} = C_I(ADD_CMD) - 0.5 * (C_I(CLK_T) + C_I(CLK_C))$
- 11) $C_{DIO} = C_{IO}(DQ, DM) - 0.5 * (C_{IO}(DQS_T) + C_{IO}(DQS_c))$
- 12) Maximum external load capacitance on ZQ pin: tbd pF.
- 13) TEN pin may be DRAM internally pulled low through a weak pull-down resistor to VSS. In this case C_{TEN} might not be valid and system shall verify TEN signal with Vendor specific information.

16. ELECTRICAL CHARACTERISTICS & AC TIMING

16.1 Reference Load for AC Timing and Output Slew Rate

Figure 23 represents the effective reference load of 50 ohms used in defining the relevant AC timing parameters of the device as well as output slew rate measurements.

Ron nominal of DQ, DQS_t and DQS_c drivers uses 34 ohms to specify the relevant AC timing parameter values of the device.

The maximum DC High level of Output signal = 1.0 * VDDQ,

The minimum DC Low level of Output signal = {34 / (34 + 50)} * VDDQ = 0.4 * VDDQ

The nominal reference level of an Output signal can be approximated by the following:

The center of maximum DC High and minimum DC Low = {(1 + 0.4) / 2} * VDDQ = 0.7 * VDDQ

The actual reference level of Output signal might vary with driver Ron and reference load tolerances. Thus, the actual reference level or midpoint of an output signal is at the widest part of the output signal's eye. Prior to measuring AC parameters, the reference level of the verification tool should be set to an appropriate level.

It is not intended as a precise representation of any particular system environment or a depiction of the actual load presented by a production tester. System designers should use IBIS or other simulation tools to correlate the timing reference load to a system environment. Manufacturers correlate to their production test conditions, generally one or more coaxial transmission lines terminated at the tester electronics.

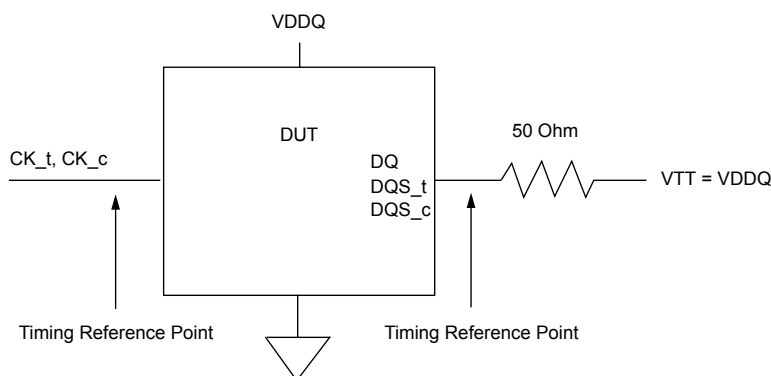

Figure 23. Reference Load for AC Timing and Output Slew Rate

16.2 tREFI

Average periodic Refresh interval (tREFI) of DDR4 SDRAM is defined as shown in the table.

[Table 51] tREFI by device density

Parameter	Symbol	2Gb	4Gb	8Gb	16Gb	Units	NOTE	
All Bank Refresh to active/refresh cmd time	tRFC	160	260	350	550	ns		
Average periodic refresh interval	tREFI	0 °C ≤ T _{CASE} ≤ 85°C	7.8	7.8	7.8	7.8	μs	
		-40 °C ≤ T _{CASE} ≤ 85°C	7.8	7.8	7.8	7.8	μs	2
		85 °C < T _{CASE} ≤ 95°C	3.9	3.9	3.9	3.9	μs	1

- NOTE :**
- Users should refer to the DRAM supplier data sheet and/or the DIMM SPD to determine if DDR4 SDRAM devices support the following options or requirements referred to in this material.
 - Supported only for Industrial Temperature.

16.3 Clock Specification

The jitter specified is a random jitter meeting a Gaussian distribution. Input clocks violating the min/max values may result in malfunction of the DDR4 SDRAM device.

16.3.1 Definition for tCK(abs)

tCK(abs) is defined as the absolute clock period, as measured from one rising edge to the next consecutive rising edge. tCK(abs) is not subject to production test.

16.3.2 Definition for tCK(avg)

tCK(avg) is calculated as the average clock period across any consecutive 200 cycle window, where each clock period is calculated from rising edge to rising edge.

$$tCK(avg) = \left(\sum_{j=1}^N tCK(abs)_j \right) / N \quad N = 200$$

16.3.3 Definition for tCH(avg) and tCL(avg)

tCH(avg) is defined as the average high pulse width, as calculated across any consecutive 200 high pulses.

$$tCH(avg) = \left(\sum_{j=1}^N tCH_j \right) / \{N \times tCK(avg)\} \quad N = 200$$

tCL(avg) is defined as the average low pulse width, as calculated across any consecutive 200 low pulses.

$$tCL(avg) = \left(\sum_{j=1}^N tCL_j \right) / \{N \times tCK(avg)\} \quad N = 200$$

16.3.4 Definition for tERR(nper)

tERR is defined as the cumulative error across n consecutive cycles of n x tCK(avg). tERR is not subject to production test.

17. TIMING PARAMETERS BY SPEED GRADE

[Table 52] Timing Parameters by Speed Bin for DDR4-1600 to DDR4-2666

Speed		DDR4-1600		DDR4-1866		DDR4-2133		DDR4-2400		DDR4-2666		Units	NOTE
Parameter	Symbol	MIN	MAX	MIN	MAX	MIN	MAX	MIN	MAX	MIN	MAX		
Clock Timing													
Minimum Clock Cycle Time (DLL off mode)	tCK(DLL_OFF)	8	20	8	20	8	20	8	20	8	20	ns	
Average Clock Period	tCK(avg)	1.25	<1.5	1.071	<1.25	0.937	<1.071	0.833	<0.937	0.750	<0.833	ns	35,36
Average high pulse width	tCH(avg)	0.48	0.52	0.48	0.52	0.48	0.52	0.48	0.52	0.48	0.52	tCK(avg)	
Average low pulse width	tCL(avg)	0.48	0.52	0.48	0.52	0.48	0.52	0.48	0.52	0.48	0.52	tCK(avg)	
Absolute Clock Period	tCK(abs)	MIN : tCK(avg)min + tJIT(per)min_tot MAX : tCK(avg)max + tJIT(per)max_tot										tCK(avg)	
Absolute clock HIGH pulse width	tCH(abs)	0.45	-	0.45	-	0.45	-	0.45	-	0.45	-	tCK(avg)	23
Absolute clock LOW pulse width	tCL(abs)	0.45	-	0.45	-	0.45	-	0.45	-	0.45	-	tCK(avg)	24
Clock Period Jitter- total	tJIT(per)_tot	-63	63	-54	54	-47	47	-42	42	-38	38	ps	23
Clock Period Jitter- deterministic	tJIT(per)_dj	-31	31	-27	27	-23	23	-21	21	-19	19	ps	26
Clock Period Jitter during DLL locking period	tJIT(per, lck)	-50	50	-43	43	-38	38	-33	33	-30	30	ps	
Cycle to Cycle Period Jitter	tJIT(cc)	-	125	-	107	-	94	-	83	-	75	ps	
Cycle to Cycle Period Jitter during DLL locking period	tJIT(cc, lck)	-	100	-	86	-	75	-	67	-	60	ps	
Duty Cycle Jitter	tJIT(duty)	TBD	TBD	TBD	TBD	TBD	TBD	TBD	TBD	TBD	TBD	ps	
Cumulative error across 2 cycles	tERR(2per)	-92	92	-79	79	-69	69	-61	61	-55	55	ps	
Cumulative error across 3 cycles	tERR(3per)	-109	109	-94	94	-82	82	-73	73	-66	66	ps	
Cumulative error across 4 cycles	tERR(4per)	-121	121	-104	104	-91	91	-81	81	-73	73	ps	
Cumulative error across 5 cycles	tERR(5per)	-131	131	-112	112	-98	98	-87	87	-78	78	ps	
Cumulative error across 6 cycles	tERR(6per)	-139	139	-119	119	-104	104	-92	92	-83	83	ps	
Cumulative error across 7 cycles	tERR(7per)	-145	145	-124	124	-109	109	-97	97	-87	87	ps	
Cumulative error across 8 cycles	tERR(8per)	-151	151	-129	129	-113	113	-101	101	-91	91	ps	
Cumulative error across 9 cycles	tERR(9per)	-156	156	-134	134	-117	117	-104	104	-94	94	ps	
Cumulative error across 10 cycles	tERR(10per)	-160	160	-137	137	-120	120	-107	107	-96	96	ps	
Cumulative error across 11 cycles	tERR(11per)	-164	164	-141	141	-123	123	-110	110	-99	99	ps	
Cumulative error across 12 cycles	tERR(12per)	-168	168	-144	144	-126	126	-112	112	-101	101	ps	
Cumulative error across 13 cycles	tERR(13per)	-172	172	-147	147	-129	129	-114	114	-103	103	ps	
Cumulative error across 14 cycles	tERR(14per)	-175	175	-150	150	-131	131	-116	116	-104	104	ps	
Cumulative error across 15 cycles	tERR(15per)	-178	178	-152	152	-133	133	-118	118	-106	106	ps	
Cumulative error across 16 cycles	tERR(16per)	-180	189	-155	155	-135	135	-120	120	-108	108	ps	
Cumulative error across 17 cycles	tERR(17per)	-183	183	-157	157	-137	137	-122	122	-110	110	ps	
Cumulative error across 18 cycles	tERR(18per)	-185	185	-159	159	-139	139	-124	124	-112	112	ps	
Cumulative error across n = 13, 14 . . . 49, 50 cycles	tERR(nper)	MIN : tERR(nper)min = ((1 + 0.68ln(n)) * tJIT(per)_total min) MAX : tERR(nper)max = ((1 + 0.68ln(n)) * tJIT(per)_total max)										ps	
Command and Address setup time to CK_t, CK_c referenced to Vih(ac) / Vil(ac) levels	tIS(base)	115	-	100	-	80	-	62	-	55	-	ps	
Command and Address setup time to CK_t, CK_c referenced to Vref levels	tIS(Vref)	215	-	200	-	180	-	162	-	145	-	ps	
Command and Address hold time to CK_t, CK_c referenced to Vih(dc) / Vil(dc) levels	tIH(base)	140	-	125	-	105	-	87	-	80	-	ps	
Command and Address hold time to CK_t, CK_c referenced to Vref levels	tIH(Vref)	215	-	200	-	180	-	162	-	145	-	ps	
Control and Address Input pulse width for each input	tIPW	600	-	525	-	460	-	410	-	385	-	ps	
Command and Address Timing													
CAS_n to CAS_n command delay for same bank group	tCCD_L	max(5 nCK, 6.250 ns)	-	max(5 nCK, 5.355 ns)	-	max(5 nCK, 5.355 ns)	-	max(5 nCK, 5 ns)	-	max(5 nCK, 5 ns)	-	nCK	34
CAS_n to CAS_n command delay for different bank group	tCCD_S	4	-	4	-	4	-	4	-	4	-	nCK	34
ACTIVATE to ACTIVATE Command delay to different bank group for 2KB page size	tRRD_S(2K)	Max(4nCK, 6 ns)	-	Max(4nCK, 5.3ns)	-	Max(4nCK, 5.3ns)	-	Max(4nCK, 5.3ns)	-	Max(4nCK, 5.3ns)	-	nCK	34
ACTIVATE to ACTIVATE Command delay to different bank group for 2KB page size	tRRD_S(1K)	Max(4nCK, 5 ns)	-	Max(4nCK, 4.2ns)	-	Max(4nCK, 3.7ns)	-	Max(4nCK, 3.3ns)	-	Max(4nCK, 3 ns)	-	nCK	34
ACTIVATE to ACTIVATE Command delay to different bank group for 1/2KB page size	tRRD_S(1/2K)	Max(4nCK, 5 ns)	-	Max(4nCK, 4.2ns)	-	Max(4nCK, 3.7ns)	-	Max(4nCK, 3.3ns)	-	Max(4nCK, 3 ns)	-	nCK	34
ACTIVATE to ACTIVATE Command delay to same bank group for 2KB page size	tRRD_L(2K)	Max(4nCK, 7.5ns)	-	Max(4nCK, 6.4ns)	-	Max(4nCK, 6.4ns)	-	Max(4nCK, 6.4ns)	-	Max(4nCK, 6.4ns)	-	nCK	34
ACTIVATE to ACTIVATE Command delay to same bank group for 1KB page size	tRRD_L(1K)	Max(4nCK, 6 ns)	-	Max(4nCK, 5.3ns)	-	Max(4nCK, 5.3ns)	-	Max(4nCK, 4.9ns)	-	Max(4nCK, 4.3ns)	-	nCK	34

[Table 52] Timing Parameters by Speed Bin for DDR4-1600 to DDR4-2666

Speed		DDR4-1600		DDR4-1866		DDR4-2133		DDR4-2400		DDR4-2666		Units	NOTE
Parameter	Symbol	MIN	MAX	MIN	MAX	MIN	MAX	MIN	MAX	MIN	MAX		
ACTIVATE to ACTIVATE Command delay to same bank group for 1/2KB page size	tRRD_L(1/2K)	Max(4nCK,6 ns)	-	Max(4nCK,5.3ns)	-	Max(4nCK,5.3ns)	-	Max(4nCK,4.9ns)	-	Max(4nCK,4.9ns)	-	nCK	34
Four activate window for 2KB page size	tFAW_2K	Max(28nCK,35ns)	-	Max(28nCK,30ns)	-	Max(28nCK,30ns)	-	Max(28nCK,30ns)	-	Max(28nCK,30ns)	-	ns	34
Four activate window for 1KB page size	tFAW_1K	Max(20nCK,25ns)	-	Max(20nCK,23ns)	-	Max(20nCK,21ns)	-	Max(20nCK,21ns)	-	Max(20nCK,21ns)	-	ns	34
Four activate window for 1/2KB page size	tFAW_1/2K	Max(16nCK,20ns)	-	Max(16nCK,17ns)	-	Max(16nCK,15ns)	-	Max(16nCK,13ns)	-	Max(16nCK,12ns)	-	ns	34
Delay from start of internal write transaction to internal read command for different bank group	tWTR_S	max(2nCK,2.5ns)	-	max(2nCK,2.5ns)	-	max(2nCK,2.5ns)	-	Max(2nCK,2.5ns)	-	Max(2nCK,2.5ns)	-	ns	1,2,e,34
Delay from start of internal write transaction to internal read command for same bank group	tWTR_L	max(4nCK,7.5ns)	-	max(4nCK,7.5ns)	-	max(4nCK,7.5ns)	-	max(4nCK,7.5ns)	-	max(4nCK,7.5ns)	-		1,34
Internal READ Command to PRE-CHARGE Command delay	tRTP	max(4nCK,7.5ns)	-	max(4nCK,7.5ns)	-	max(4nCK,7.5ns)	-	max(4nCK,7.5ns)	-	max(4nCK,7.5ns)	-		
WRITE recovery time	tWR	15	-	15	-	15	-	15	-	15	-	ns	1
Write recovery time when CRC and DM are enabled	tWR_CRC_DM	tWR+max(4nCK,3.75ns)	-	tWR+max(5nCK,3.75ns)	-	tWR+max(5nCK,3.75ns)	-	tWR+max(5nCK,3.75ns)	-	tWR+max(5nCK,3.75ns)	-	ns	1,28
Delay from start of internal write transaction to internal read command for different bank group with both CRC and DM enabled	tWTR_S_CRC_DM	tWTR_S+max(4nCK,3.75ns)	-	tWTR_S+max(5nCK,3.75ns)	-	tWTR_S+max(5nCK,3.75ns)	-	tWTR_S+max(5nCK,3.75ns)	-	tWTR_S+max(5nCK,3.75ns)	-	ns	2,29,34
Delay from start of internal write transaction to internal read command for same bank group with both CRC and DM enabled	tWTR_L_CRC_DM	tWTR_L+max(4nCK,3.75ns)	-	tWTR_L+max(5nCK,3.75ns)	-	tWTR_L+max(5nCK,3.75ns)	-	tWTR_L+max(5nCK,3.75ns)	-	tWTR_L+max(5nCK,3.75ns)	-	ns	3,30,34
DLL locking time	tDLLK	597	-	597	-	768	-	768	-	1024	-	nCK	
Mode Register Set command cycle time	tMRD	8	-	8	-	8	-	8	-	8	-	nCK	
Mode Register Set command update delay	tMOD	max(24nCK,15ns)	-	max(24nCK,15ns)	-	max(24nCK,15ns)	-	max(24nCK,15ns)	-	max(24nCK,15ns)	-	nCK	50
Multi-Purpose Register Recovery Time	tMPRR	1	-	1	-	1	-	1	-	1	-	nCK	33
Multi Purpose Register Write Recovery Time	tWR_MPR	tMOD (min) + AL + PL	-	tMOD (min) + AL + PL	-	tMOD (min) + AL + PL	-	tMOD (min) + AL + PL	-	tMOD (min) + AL + PL	-		
Auto precharge write recovery + pre-charge time	tDAL(min)	Programmed WR + roundup (tRP / tCK(avg))										nCK	
DQ0 or DQL0 driven to 0 set-up time to first DQS rising edge	tPDA_S	0.5	-	0.5	-	0.5	-	0.5	-	0.5	-	UI	45,47
DQ0 or DQL0 driven to 0 hold time from last DQS falling edge	tPDA_H	0.5	-	0.5	-	0.5	-	0.5	-	0.5	-	UI	46,47
CS_n to Command Address Latency													
CS_n to Command Address Latency	tCAL	max(3 nCK, 3.748 ns)	-	max(3 nCK, 3.748 ns)	-	max(3 nCK, 3.748 ns)	-	max(3 nCK, 3.748 ns)	-	max(3 nCK, 3.748 ns)	-	nCK	
Mode Register Set command cycle time in CAL mode	tMRD_tCAL	tMOD+tCAL	-	tMOD+tCAL	-	tMOD+tCAL	-	tMOD+tCAL	-	tMOD+tCAL	-	nCK	
Mode Register Set update delay in CAL mode	tMOD_tCAL	tMOD+tCAL	-	tMOD+tCAL	-	tMOD+tCAL	-	tMOD+tCAL	-	tMOD+tCAL	-	nCK	
DRAM Data Timing													
DQS_t, DQS_c to DQ skew, per group, per access	tDQSQ	-	0.16	-	0.16	-	0.16	-	0.17	-	0.18	tCK(avg)/2	13,18,39,49
DQ output hold time per group, per access from DQS_t, DQS_c	tQH	0.76	-	0.76	-	0.76	-	0.74	-	0.74	-	tCK(avg)/2	13,17,18,39,49
Data Valid Window per device, per UI: (tQH - tDQSQ) of each UI on a given DRAM	tDVWd	0.63	-	0.63	-	0.64	-	0.64	-	TBD	-	UI	17,18,39,49
Data Valid Window, per pin, per UI: (tQH - tDQSQ) each UI on a pin of a given DRAM	tDVWp	0.66	-	0.66	-	0.69	-	0.72	-	0.72	-	UI	17,18,39,49
DQ low impedance time from CK_t, CK_c	tLZ(DQ)	-450	225	-390	195	-360	180	-330	175	-310	170	ps	39
DQ high impedance time from CK_t, CK_c	tHZ(DQ)	-	225	-	195	-	180	-	175	-	170	ps	39
Data Strobe Timing													
DQS_t, DQS_c differential READ Pre-amble (1 clock preamble)	tRPRE	0.9	NOTE44	0.9	NOTE44	0.9	NOTE44	0.9	NOTE 44	0.9	NOTE 44	tCK	40
DQS_t, DQS_c differential READ Preamble (2 clock preamble)	tRPRE2	NA	NA	NA	NA	NA	NA	1.8	NOTE 44	1.8	NOTE 44	tCK	41
DQS_t, DQS_c differential READ Postamble	tRPST	0.33	NOTE 45	0.33	NOTE 45	0.33	NOTE 45	0.33	NOTE 45	0.33	NOTE 45	tCK	
DQS_t, DQS_c differential output high time	tQSH	0.4	-	0.4	-	0.4	-	0.4	-	0.4	-	tCK	21
DQS_t, DQS_c differential output low time	tQSL	0.4	-	0.4	-	0.4	-	0.4	-	0.4	-	tCK	20

[Table 52] Timing Parameters by Speed Bin for DDR4-1600 to DDR4-2666

Speed		DDR4-1600		DDR4-1866		DDR4-2133		DDR4-2400		DDR4-2666		Units	NOTE
Parameter	Symbol	MIN	MAX	MIN	MAX	MIN	MAX	MIN	MAX	MIN	MAX		
DQS _t , DQS _c differential WRITE Preamble (1 clock preamble)	tWPRE	0.9	-	0.9	-	0.9	-	0.9	-	0.9	-	tCK	42
DQS _t , DQS _c differential WRITE Preamble (2 clock preamble)	tWPRE2	NA	-	NA	-	NA	-	1.8	-	1.8	-	tCK	43
DQS _t , DQS _c differential WRITE Postamble	tWPST	0.33	-	0.33	-	0.33	-	0.33	-	0.33	-	tCK	
DQS _t and DQS _c low-impedance time (Referenced from RL-1)	tLZ(DQS)	-450	225	-390	195	-360	180	-330	175	-310	170	ps	
DQS _t and DQS _c high-impedance time (Referenced from RL+BL/2)	tHZ(DQS)	-	225	-	195	-	180	-	175	-	170	ps	
DQS _t , DQS _c differential input low pulse width	tDQSL	0.46	0.54	0.46	0.54	0.46	0.54	0.46	0.54	0.46	0.54	tCK	
DQS _t , DQS _c differential input high pulse width	tDQSH	0.46	0.54	0.46	0.54	0.46	0.54	0.46	0.54	0.46	0.54	tCK	
DQS _t , DQS _c rising edge to CK _t , CK _c rising edge (1 clock preamble)	tDQSS	-0.27	0.27	-0.27	0.27	-0.27	0.27	-0.27	0.27	-0.27	0.27	tCK	42
DQS _t , DQS _c rising edge to CK _t , CK _c rising edge (2 clock preamble)	tDQSS2	N/A	N/A	N/A	N/A	N/A	N/A	N/A	N/A	N/A	N/A	tCK	43
DQS _t , DQS _c falling edge setup time to CK _t , CK _c rising edge	tDSS	0.18	-	0.18	-	0.18	-	0.18	-	0.18	-	tCK	
DQS _t , DQS _c falling edge hold time from CK _t , CK _c rising edge	tDSH	0.18	-	0.18	-	0.18	-	0.18	-	0.18	-	tCK	
DQS _t , DQS _c rising edge output timing location from rising CK _t , CK _c with DLL On mode	tDQSCK (DLL On)	-225	225	-195	195	-180	180	-175	175	-170	170	ps	37,38,39
DQS _t , DQS _c rising edge output variance window per DRAM	tDQSCKI (DLL On)	-	370	-	330	-	310	-	290	-	270	ps	37,38,39
MPSM Timing													
Command path disable delay upon MPSM entry	tMPED	tMOD(min)+tCP-DED(min)	-	tMOD(min)+tCP-DED(min)	-	tMOD(min)+tCP-DED(min)	-	tMOD(min)+tCP-DED(min)	-	tMOD(min)+tCP-DED(min)	-		
Valid clock requirement after MPSM entry	tCKMPE	tMOD(min)+tCP-DED(min)	-	tMOD(min)+tCP-DED(min)	-	tMOD(min)+tCP-DED(min)	-	tMOD(min)+tCP-DED(min)	-	tMOD(min)+tCP-DED(min)	-		
Valid clock requirement before MPSM exit	tCKMPX	tCKSRX(min)	-	tCKSRX(min)	-	tCKSRX(min)	-	tCKSRX(min)	-	tCKSRX(min)	-		
Exit MPSM to commands not requiring a locked DLL	tXMP	tXS(min)	-	tXS(min)	-	tXS(min)	-	tXS(min)	-	tXS(min)	-		
Exit MPSM to commands requiring a locked DLL	tXMPDLL	tXMP(min)+tXSDLL(min)	-	tXMP(min)+tXSDLL(min)	-	tXMP(min)+tXSDLL(min)	-	tXMP(min)+tXSDLL(min)	-	tXMP(min)+tXSDLL(min)	-		
CS setup time to CKE	tMPX_S	tIS(min)+tIH(min)	-	tIS(min)+tIH(min)	-	tIS(min)+tIH(min)	-	tIS(min)+tIH(min)	-	tIS(min)+tIH(min)	-		
CS _n High hold time to CKE rising edge	tMPX_HH	tXP(min)	-	tXP(min)	-	tXP(min)	-	tXP(min)	-	tXP(min)	-		
CS _n Low hold time to CKE rising edge	tMPX_LH	12	tXMP-10ns	12	tXMP-10ns	12	tXMP-10ns	12	tXMP-10ns	12	tXMP-10ns	ns	51
Calibration Timing													
Power-up and RESET calibration time	tZQinit	1024	-	1024	-	1024	-	1024	-	1024	-	nCK	
Normal operation Full calibration time	tZQoper	512	-	512	-	512	-	512	-	512	-	nCK	
Normal operation Short calibration time	tZQCS	128	-	128	-	128	-	128	-	128	-	nCK	
Reset/Self Refresh Timing													
Exit Reset from CKE HIGH to a valid command	tXPR	max(5nCK, tRFC(min)+10ns)	-	max(5nCK, tRFC(min)+10ns)	-	max(5nCK, tRFC(min)+10ns)	-	max(5nCK, tRFC(min)+10ns)	-	max(5nCK, tRFC(min)+10ns)	-	nCK	
Exit Self Refresh to commands not requiring a locked DLL	tXS	tRFC(min)+10ns	-	tRFC(min)+10ns	-	tRFC(min)+10ns	-	tRFC(min)+10ns	-	tRFC(min)+10ns	-	nCK	
SRX to commands not requiring a locked DLL in Self Refresh ABORT	tX-S_ABORT(min)	tRFC4(min)+10ns	-	tRFC4(min)+10ns	-	tRFC4(min)+10ns	-	tRFC4(min)+10ns	-	tRFC4(min)+10ns	-	nCK	
Exit Self Refresh to ZQCL, ZQCS and MRS (CL, CWL, WR, RTP and Gear Down)	tXS_FAST(min)	tRFC4(min)+10ns	-	tRFC4(min)+10ns	-	tRFC4(min)+10ns	-	tRFC4(min)+10ns	-	tRFC4(min)+10ns	-	nCK	
Exit Self Refresh to commands requiring a locked DLL	tXSDLL	tDLLK(min)	-	tDLLK(min)	-	tDLLK(min)	-	tDLLK(min)	-	tDLLK(min)	-	nCK	
Minimum CKE low width for Self refresh entry to exit timing	tCKESR	tCKE(min)+1nCK	-	tCKE(min)+1nCK	-	tCKE(min)+1nCK	-	tCKE(min)+1nCK	-	tCKE(min)+1nCK	-	nCK	
Minimum CKE low width for Self refresh entry to exit timing with CA Parity enabled	tCKESR_PAR	tCKE(min)+1nCK+PL	-	tCKE(min)+1nCK+PL	-	tCKE(min)+1nCK+PL	-	tCKE(min)+1nCK+PL	-	tCKE(min)+1nCK+PL	-	nCK	
Valid Clock Requirement after Self Refresh Entry (SRE) or Power-Down Entry (PDE)	tCKSRE	max(5nCK, 10ns)	-	max(5nCK, 10ns)	-	max(5nCK, 10ns)	-	max(5nCK, 10ns)	-	max(5nCK, 10ns)	-	nCK	

[Table 52] Timing Parameters by Speed Bin for DDR4-1600 to DDR4-2666

Speed		DDR4-1600		DDR4-1866		DDR4-2133		DDR4-2400		DDR4-2666		Units	NOTE
Parameter	Symbol	MIN	MAX	MIN	MAX	MIN	MAX	MIN	MAX	MIN	MAX		
Valid Clock Requirement after Self Refresh Entry (SRE) or Power-Down when CA Parity is enabled	tCKSRE_PAR	max (5nCK, 10ns) +PL	-	max (5nCK, 10ns) +PL	-	max (5nCK, 10ns) +PL	-	max (5nCK, 10ns) +PL	-	max (5nCK, 10ns) +PL	-	nCK	
Valid Clock Requirement before Self Refresh Exit (SRX) or Power-Down Exit (PDX) or Reset Exit	tCKSRX	max(5nCK, 10ns)	-	max(5nCK, 10ns)	-	max(5nCK, 10ns)	-	max(5nCK, 10ns)	-	max(5nCK, 10ns)	-	nCK	
Power Down Timing													
Exit Power Down with DLL on to any valid command; Exit Precharge Power Down with DLL frozen to commands not requiring a locked DLL	tXP	max (4nCK, 6ns)	-	max (4nCK, 6ns)	-	max (4nCK, 6ns)	-	max (4nCK, 6ns)	-	max (4nCK, 6ns)	-	nCK	
CKE minimum pulse width	tCKE	max (3nCK, 5ns)	-	max (3nCK, 5ns)	-	max (3nCK, 5ns)	-	max (3nCK, 5ns)	-	max (3nCK, 5ns)	-	nCK	31,32
Command pass disable delay	tCPDED	4	-	4	-	4	-	4	-	4	-	nCK	
Power Down Entry to Exit Timing	tPD	tCKE(min)	9*tREFI	tCKE(min)	9*tREFI	tCKE(min)	9*tREFI	tCKE(min)	9*tREFI	tCKE(min)	9*tREFI	nCK	6
Timing of ACT command to Power Down entry	tACTPDEN	1	-	1	-	2	-	2	-	2	-	nCK	7
Timing of PRE or PREA command to Power Down entry	tPRPDEN	1	-	1	-	2	-	2	-	2	-	nCK	7
Timing of RD/RDA command to Power Down entry	tRDPDEN	RL+4+1	-	RL+4+1	-	RL+4+1	-	RL+4+1	-	RL+4+1	-	nCK	
Timing of WR command to Power Down entry (BL80TF, BL8MRS, BC40TF)	tWRPDEN	WL+4+(tWR/tCK(avg))	-	WL+4+(tWR/tCK(avg))	-	WL+4+(tWR/tCK(avg))	-	WL+4+(tWR/tCK(avg))	-	WL+4+(tWR/tCK(avg))	-	nCK	4
Timing of WRA command to Power Down entry (BL80TF, BL8MRS, BC40TF)	tWRAPDEN	WL+4+WR+1	-	WL+4+WR+1	-	WL+4+WR+1	-	WL+4+WR+1	-	WL+4+WR+1	-	nCK	5
Timing of WR command to Power Down entry (BC4MRS)	tWRPBC4DEN	WL+2+(tWR/tCK(avg))	-	WL+2+(tWR/tCK(avg))	-	WL+2+(tWR/tCK(avg))	-	WL+2+(tWR/tCK(avg))	-	WL+2+(tWR/tCK(avg))	-	nCK	4
Timing of WRA command to Power Down entry (BC4MRS)	tWRAPBC4DEN	WL+2+WR+1	-	WL+2+WR+1	-	WL+2+WR+1	-	WL+2+WR+1	-	WL+2+WR+1	-	nCK	5
Timing of REF command to Power Down entry	tREFPDEN	1	-	1	-	2	-	2	-	2	-	nCK	7
Timing of MRS command to Power Down entry	tMRSPDEN	tMOD(min)	-	tMOD(min)	-	tMOD(min)	-	tMOD(min)	-	tMOD(min)	-		
PDA Timing													
Mode Register Set command cycle time in PDA mode	tMRD_PDA	max(16nCK, 10ns)	-	max(16nCK, 10ns)	-	max(16nCK, 10ns)	-	max(16nCK, 10ns)	-	max(16nCK, 10ns)	-	nCK	
Mode Register Set command update delay in PDA mode	tMOD_PDA	tMOD		tMOD		tMOD		tMOD		tMOD			
ODT Timing													
Asynchronous RTT turn-on delay (Power-Down with DLL frozen)	tAONAS	1.0	9.0	1.0	9.0	1.0	9.0	1.0	9.0	1.0	9.0	ns	
Asynchronous RTT turn-off delay (Power-Down with DLL frozen)	tAOFAS	1.0	9.0	1.0	9.0	1.0	9.0	1.0	9.0	1.0	9.0	ns	
RTT dynamic change skew	tADC	0.3	0.7	0.3	0.7	0.3	0.7	0.3	0.7	0.28	0.72	tCK(avg)	
Write Leveling Timing													
First DQS _i /DQS _c rising edge after write leveling mode is programmed	tWLMRD	40	-	40	-	40	-	40	-	40	-	nCK	12
DQS _i /DQS _c delay after write leveling mode is programmed	tWLDQSEN	25	-	25	-	25	-	25	-	25	-	nCK	12
Write leveling setup time from rising CK _i , CK _c crossing to rising DQS _i /DQS _c crossing	tWLS	0.13	-	0.13	-	0.13	-	0.13	-	0.13	-	tCK(avg)	
Write leveling hold time from rising DQS _i /DQS _c crossing to rising CK _i , CK _c crossing	tWLH	0.13	-	0.13	-	0.13	-	0.13	-	0.13	-	tCK(avg)	
Write leveling output delay	tWLO	0	9.5	0	9.5	0	9.5	0	9.5	0	9.5	ns	
Write leveling output error	tWLOE	0	2	0	2	0	2	0	2	0	2	ns	
CA Parity Timing													
Commands not guaranteed to be executed during this time	tPAR_UNKNOWN	-	PL	-	PL	-	PL	-	PL	-	PL		
Delay from errant command to ALERT _n assertion	tPAR_ALERT_ON	-	PL+6ns	-	PL+6ns	-	PL+6ns	-	PL+6ns	-	PL+6ns		
Pulse width of ALERT _n signal when asserted	tPAR_ALERT_PW	48	96	56	112	64	128	72	144	80	160	nCK	
Time from when Alert is asserted till controller must start providing DES commands in Persistent CA parity mode	tPAR_ALERT_RSP	-	43	-	50	-	57	-	64	-	71	nCK	
Parity Latency	PL	4		4		4		5		5		nCK	
CRC Error Reporting													
CRC error to ALERT _n latency	tCRC_ALERT	3	13	3	13	3	13	3	13	3	13	ns	
CRC ALERT _n pulse width	CRC_ALERT_PW	6	10	6	10	6	10	6	10	6	10	nCK	

[Table 52] Timing Parameters by Speed Bin for DDR4-1600 to DDR4-2666

Speed		DDR4-1600		DDR4-1866		DDR4-2133		DDR4-2400		DDR4-2666		Units	NOTE
Parameter	Symbol	MIN	MAX	MIN	MAX	MIN	MAX	MIN	MAX	MIN	MAX		
Geardown timing													
Exit RESET from CKE HIGH to a valid MRS geardown (T2/Reset)	tXPR_GEAR	-	-	-	-	-	-	-	-	tXPR	-		
CKE High Assert to Gear Down Enable time(T2/CKE)	tXS_GEAR	-	-	-	-	-	-	-	-	tXS	-		
MRS command to Sync pulse time(T3)	tSYNC_GEAR	-	-	-	-	-	-	-	-	tMOD + 4tCK	-		27
Sync pulse to First valid command(T4)	tCMD_GEAR	-	-	-	-	-	-	-	-	tMOD	-		27
Geardown setup time	tGEAR_setup	-	-	-	-	-	-	-	-	2	-	nCK	
Geardown hold time	tGEAR_hold	-	-	-	-	-	-	-	-	2	-	nCK	
tREFI													
tRFC1 (min)	2Gb	160	-	160	-	160	-	160	-	160	-	ns	34
	4Gb	260	-	260	-	260	-	260	-	260	-	ns	34
	8Gb	350	-	350	-	350	-	350	-	350	-	ns	34
	16Gb	550	-	550	-	550	-	550	-	550	-	ns	34
tRFC2 (min)	2Gb	110	-	110	-	110	-	110	-	110	-	ns	34
	4Gb	160	-	160	-	160	-	160	-	160	-	ns	34
	8Gb	260	-	260	-	260	-	260	-	260	-	ns	34
	16Gb	350	-	350	-	350	-	350	-	350	-	ns	34
tRFC4 (min)	2Gb	90	-	90	-	90	-	90	-	90	-	ns	34
	4Gb	110	-	110	-	110	-	110	-	110	-	ns	34
	8Gb	160	-	160	-	160	-	160	-	160	-	ns	34
	16Gb	260	-	260	-	260	-	260	-	260	-	ns	34

NOTE :

- 1) Start of internal write transaction is defined as follows :
 For BL8 (Fixed by MRS and on-the-fly) : Rising clock edge 4 clock cycles after WL.
 For BC4 (on-the-fly) : Rising clock edge 4 clock cycles after WL.
 For BC4 (fixed by MRS) : Rising clock edge 2 clock cycles after WL.
- 2) A separate timing parameter will cover the delay from write to read when CRC and DM are simultaneously enabled
- 3) Commands requiring a locked DLL are: READ (and RAP) and synchronous ODT commands.
- 4) tWR is defined in ns, for calculation of tWRPDEN it is necessary to round up tWR/tCK following rounding algorithm defined in "17.1 Rounding Algorithms".
- 5) WR in clock cycles as programmed in MR0.
- 6) tREFI depends on TOPER.
- 7) CKE is allowed to be registered low while operations such as row activation, precharge, autoprecharge or refresh are in progress, but power-down IDD spec will not be applied until finishing those operations.
- 8) For these parameters, the DDR4 SDRAM device supports $t_{nPARAM}[nCK]=RU\{t_{PARAM}[ns]/t_{CK}(avg)[ns]\}$, which is in clock cycles assuming all input clock jitter specifications are satisfied.
- 9) When CRC and DM are both enabled, tWR_CRC_DM is used in place of tWR.
- 10) When CRC and DM are both enabled tWTR_S_CRC_DM is used in place of tWTR_S.
- 11) When CRC and DM are both enabled tWTR_L_CRC_DM is used in place of tWTR_L.
- 12) The max values are system dependent.
- 13) DQ to DQS total timing per group where the total includes the sum of deterministic and random timing terms for a specified BER. BER spec and measurement method are tbd.
- 14) The deterministic component of the total timing. Measurement method tbd.
- 15) DQ to DQ static offset relative to strobe per group. Measurement method tbd.
- 16) This parameter will be characterized and guaranteed by design.
- 17) When the device is operated with the input clock jitter, this parameter needs to be derated by the actual $t_{jit(per)}_{total}$ of the input clock. (output deratings are relative to the SDRAM input clock). Example tbd.
- 18) DRAM DBI mode is off.
- 19) DRAM DBI mode is enabled. Applicable to x8 and x16 DRAM only.
- 20) tQSL describes the instantaneous differential output low pulse width on DQS_t - DQS_c, as measured from on falling edge to the next consecutive rising edge
- 21) tQSH describes the instantaneous differential output high pulse width on DQS_t - DQS_c, as measured from on falling edge to the next consecutive rising edge
- 22) There is no maximum cycle time limit besides the need to satisfy the refresh interval tREFI
- 23) tCH(abs) is the absolute instantaneous clock high pulse width, as measured from one rising edge to the following falling edge
- 24) tCL(abs) is the absolute instantaneous clock low pulse width, as measured from one falling edge to the following rising edge
- 25) Total jitter includes the sum of deterministic and random jitter terms for a specified BER. BER target and measurement method are tbd.
- 26) The deterministic jitter component out of the total jitter. This parameter is characterized and guaranteed by design.
- 27) This parameter has to be even number of clocks
- 28) When CRC and DM are both enabled, tWR_CRC_DM is used in place of tWR.
- 29) When CRC and DM are both enabled tWTR_S_CRC_DM is used in place of tWTR_S.
- 30) When CRC and DM are both enabled tWTR_L_CRC_DM is used in place of tWTR_L.
- 31) After CKE is registered LOW, CKE signal level shall be maintained below VILDC for tCKE specification (Low pulse width).
- 32) After CKE is registered HIGH, CKE signal level shall be maintained above VIHDC for tCKE specification (HIGH pulse width).
- 33) Defined between end of MPR read burst and MRS which reloads MPR or disables MPR function.
- 34) Parameters apply from tCK(avg)min to tCK(avg)max at all standard JEDEC clock period values as stated in the Speed Bin Tables.
- 35) This parameter must keep consistency with Speed-Bin Tables shown in section 10.
- 36) DDR4-1600 AC timing apply if DRAM operates at lower than 1600 MT/s data rate. $UI=t_{CK}(avg).min/2$.
- 37) applied when DRAM is in DLL ON mode.
- 38) Assume no jitter on input clock signals to the DRAM.
- 39) Value is only valid for RONNOM = 34 ohms.
- 40) 1tCK toggle mode with setting MR4:A11 to 0.
- 41) 2tCK toggle mode with setting MR4:A11 to 1, which is valid for DDR4-2400 and 2666 speed grade.
- 42) 1tCK mode with setting MR4:A12 to 0.
- 43) 2tCK mode with setting MR4:A12 to 1, which is valid for DDR4-2400 and 2666 speed grade.
- 44) The maximum read preamble is bounded by tLZ(DQS)min on the left side and tDQSCK(max) on the right side. See Figure "Clock to Data Strobe Relationship" in Operation datasheet. Boundary of DQS Low-Z occur one cycle earlier in 2tCK toggle mode which is illustrated in "Read Preamble" section.
- 45) DQ falling signal middle-point of transferring from High to Low to first rising edge of DQS diff-signal cross-point
- 46) last falling edge of DQS diff-signal cross-point to DQ rising signal middle-point of transferring from Low to High
- 47) VrefDQ value must be set to either its midpoint or Vcent_DQ(midpoint) in order to capture DQ0 or DQL0 low level for entering PDA mode.
- 48) The maximum read postamble is bound by tDQSCK(min) plus tQSH(min) on the left side and tHZ(DQS)max on the right side. See Figure "Clock to Data Strobe Relationship" in Operation datasheet.
- 49) Reference level of DQ output signal is specified with a midpoint as a widest part of Output signal eye which should be approximately $0.7 * VDDQ$ as a center level of the static single-ended output peak-to-peak swing with a driver impedance of 34 ohms and an effective test load of 50 ohms to VTT = VDDQ.
- 50) For MR7 commands, the minimum delay to a subsequent non-MRS command is 5nCK.
- 51) tMPX_LH(max) is defined with respect to actual tXMP in system as opposed to tXMP(min).

17.1 Rounding Algorithms

Software algorithms for calculation of timing parameters are subject to rounding errors from many sources. For example, a system may use a memory clock with a nominal frequency of 933.33... MHz, or a clock period of 1.0714... ns. Similarly, a system with a memory clock frequency of 1066.66... MHz yields mathematically a clock period of 0.9375... ns. In most cases, it is impossible to express all digits after the decimal point exactly, and rounding must be done because the DDR4 SDRAM specification establishes a minimum granularity for timing parameters of 1 ps.

Rules for rounding must be defined to allow optimization of device performance without violating device parameters. These algorithms rely on results that are within correction factors on device testing and specification to avoid losing performance due to rounding errors.

These rules are:

- Clock periods such as tCKAVGmin are defined to 1 ps of accuracy; for example, 0.9375... ns is defined as 937 ps and 1.0714... ns is defined as 1071 ps.
- Using real math, parameters like tAAmin, tRCDmin, etc. which are programmed in systems in numbers of clocks (nCK) but expressed in units of time (in ns) are divided by the clock period (in ns) yielding a unitless ratio, a correction factor of 2.5% is subtracted, then the result is set to the next higher integer number of clocks:

$$nCK = \text{ceiling} [(parameter_in_ns / application_tCK_in_ns) - 0.025]$$

- Alternatively, programmers may prefer to use integer math instead of real math by expressing timing in ps, scaling the desired parameter value by 1000, dividing by the application clock period, adding an inverse correction factor of 97.4%, dividing the result by 1000, then truncating down to the next lower integer value:

$$nCK = \text{truncate} [((parameter_in_ps \times 1000) / (application_tCK_in_ps) + 974) / 1000]$$

- Either algorithm yields identical results

17.2 The DQ input receiver compliance mask for voltage and timing

The DQ input receiver compliance mask for voltage and timing is shown in the figure below. The receiver mask (Rx Mask) defines area the input signal must not encroach in order for the DRAM input receiver to be expected to be able to successfully capture a valid input signal with BER of 1e-16; any input signal encroaching within the Rx Mask is subject to being invalid data. The Rx Mask is the receiver property for each DQ input pin and it is not the valid data-eye.

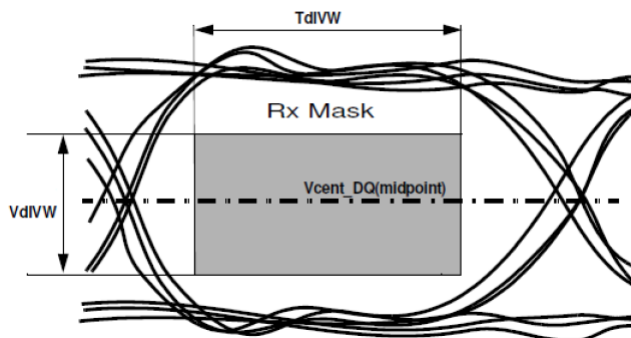

Figure 24. DQ Receiver(Rx) compliance mask

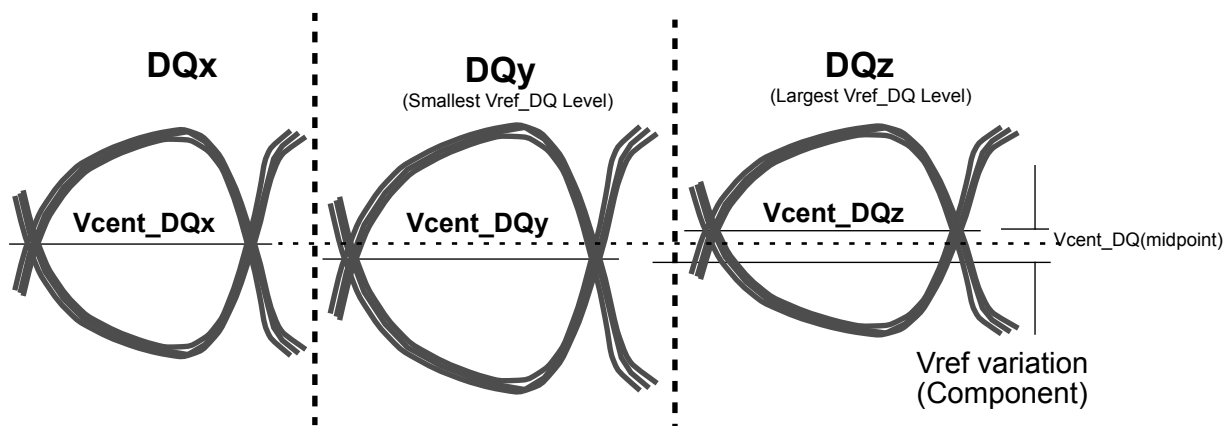
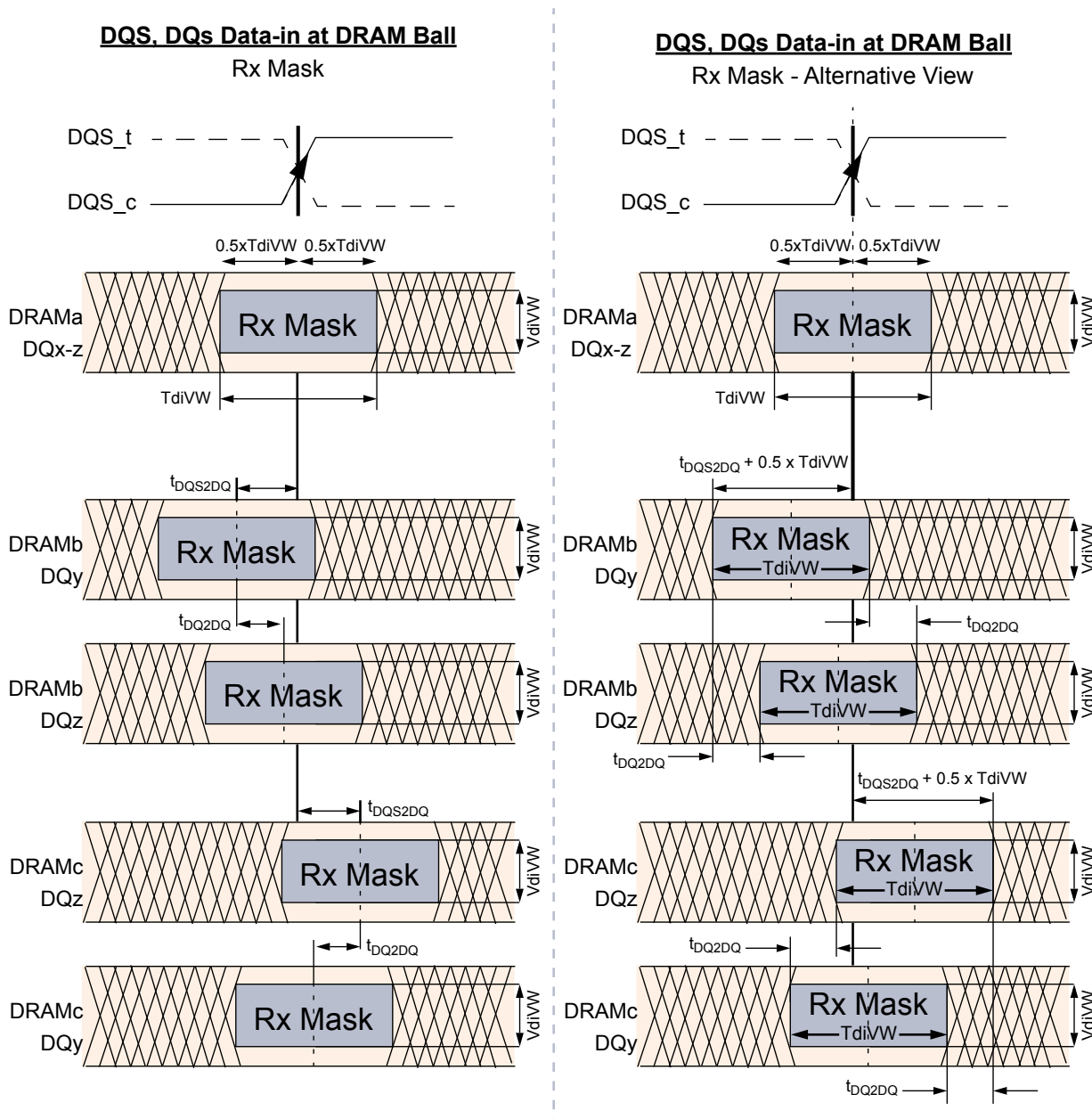

Figure 25. Vcent_DQ Variation to Vcent_DQ(midpoint)

The Vref_DQ voltage is an internal reference voltage level that shall be set to the properly trained setting, which is generally Vcent_DQ(midpoint), in order to have valid Rx Mask values.

Vcent_DQ is defined as the midpoint between the largest Vref_DQ voltage level and the smallest Vref_DQ voltage level across all DQ pins for a given DDR4 DRAM component. Each DQ pin Vref level is defined by the center, i.e. widest opening, of the cumulative data input eye as depicted in Figure 25. This clarifies that any DDR4 DRAM component level variation must be accounted for within the DDR4 DRAM Rx mask. The component level Vref will be set by the system to account for Ron and ODT settings.



NOTE : DQx represents an optimally centered mask.
 DQy represents earliest valid mask.
 DQz represents latest valid mask.

NOTE : DRAMa represents a DRAM without any DQS/DQ skews.
 DRAMb represents a DRAM with early skews (negative t_{DQS2DQ}).
 DRAMc represents a DRAM with delayed skews (positive t_{DQS2DQ}).

NOTE : Figures show skew allowed between DRAM to DRAM and DQ to DQ for a DRAM. Signals assume data centered aligned at DRAM Latch.
 T_{diPW} is not shown; composite data-eyes shown would violate T_{diPW} .
 VCEN_T DQ(midpoint) is not shown but is assumed to be midpoint of V_{diVW} .

Figure 26. DQS to DQ and DQ to DQ Timings at DRAM Balls

All of the timing terms in Figure 26 are measured at the V_{diVW} voltage levels centered around V_{cent_DQ} and are referenced to the DQS_t/DQS_c center aligned to the DQ per pin.

The rising edge slew rates are defined by srr1 and srr2. The slew rate measurement points for a rising edge are shown in Figure 27 below: A low to high transition tr1 is measured from 0.5*VdiVW(max) below Vcent_DQ(midpoint) to the last transition through 0.5*VdiVW(max) above Vcent_DQ(midpoint) while tr2 is measured from the last transition through 0.5*VdiVW(max) above Vcent_DQ(midpoint) to the first transition through the 0.5*VIHL_AC(min) above Vcent_DQ(midpoint).

Rising edge slew rate equations:

$$srr1 = VdiVW(max) / tr1$$

$$srr2 = (VIHL_AC(min) - VdiVW(max)) / (2*tr2)$$

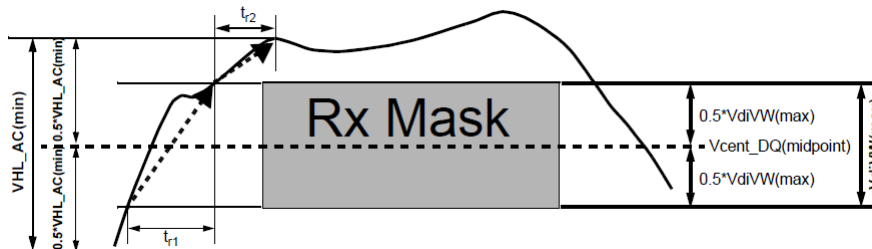

Figure 27. Slew Rate Conditions For Rising Transition

The falling edge slew rates are defined by srf1 and srf2. The slew rate measurement points for a falling edge are shown in Figure 28 below: A high to low transition tf1 is measured from 0.5*VdiVW(max) above Vcent_DQ(midpoint) to the last transition through 0.5*VdiVW(max) below Vcent_DQ(midpoint) while tf2 is measured from the last transition through 0.5*VdiVW(max) below Vcent_DQ(midpoint) to the first transition through the 0.5*VIHL_AC(min) below Vcent_DQ(pin mid).

Falling edge slew rate equations:

$$srf1 = VdiVW(max) / tf1$$

$$srf2 = (VIHL_AC(min) - VdiVW(max)) / (2*tf2)$$

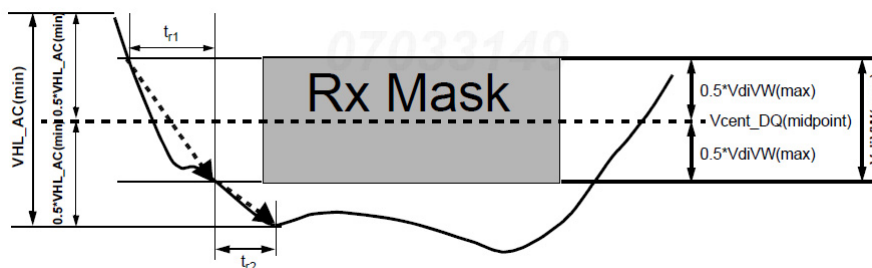

Figure 28. Slew Rate Conditions For Falling Transition

[Table 53] DRAM DQs In Receive Mode;

Symbol	Parameter	1600/1866/2133		2400		2666		Unit	NOTE
		min	max	min	max	min	max		
VdIVW	Rx Mask voltage - pk-pk	-	136	-	130	-	120	mV	1,2,10
TdIVW	Rx timing window	-	0.2	-	0.2	-	0.22	UI*	1,2,10
VIHL_AC	DQ AC input swing pk-pk	186	-	160	-	150	-	mV	3,4,10
TdIPW	DQ input pulse width	0.58	-	0.58	-	0.58	-	UI*	5,10
tDQS2DQ	Rx Mask DQS to DQ offset	-0.17	0.17	-0.17	0.17	-0.19	0.19	UI*	6, 10
tDQ2DQ	Rx Mask DQ to DQ offset	-	TBD	-	TBD	-	0.105	UI*	7
srr1, srf1	Input Slew Rate over VdIVW if tCK > 0.937ns	1.0	9	1.0	9	1.0	9	V/ns	8,10
	Input Slew Rate over VdIVW if 0.937ns > tCK >= 0.625ns	-	-	1.25	9	1.25	9	V/ns	8,10
srr2	Rising Input Slew Rate over 1/2 VIHL_AC	0.2*srr1	9	0.2*srr1	9	0.2*srr1	9	V/ns	9,10
srf2	Falling Input Slew Rate over 1/2 VIHL_AC	0.2*srf1	9	0.2*srf1	9	0.2*srf1	9	V/ns	9,10

* UI=tck(avg)min/2

NOTE :

- 1) Data Rx mask voltage and timing total input valid window where VdIVW is centered around Vcent_DQ(midpoint) after VrefDQ training is completed. The data Rx mask is applied per bit and should include voltage and temperature drift terms. The input buffer design specification is to achieve at least a BER = e-16 when the RxMask is not violated. The BER will be characterized and extrapolated if necessary using a dual dirac method from a higher BER(tbd).
- 2) Defined over the DQ internal Vref range 1.
- 3) See Overshoot and Undershoot Specifications.
- 4) DQ input pulse signal swing into the receiver must meet or exceed VIHL AC(min). VIHL_AC(min) is to be achieved on an UI basis when a rising and falling edge occur in the same UI, i.e. a valid TdiPW.
- 5) DQ minimum input pulse width defined at the Vcent_DQ(midpoint).
- 6) DQS to DQ offset is skew between DQS and DQs within a nibble (x4) or word (x8, x16) at the DDR4 SDRAM balls over process, voltage, and temperature.
- 7) DQ to DQ offset is skew between DQs within a nibble (x4) or word (x8, x16) at the DDR4 SDRAM balls for a given component over process, voltage, and temperature.
- 8) Input slew rate over VdIVW Mask centered at Vcent_DQ(midpoint). Slowest DQ slew rate to fastest DQ slew rate per transition edge must be within 1.7 V/ns of each other.
- 9) Input slew rate between VdIVW Mask edge and VIHL_AC(min) points.
- 10) All Rx Mask specifications must be satisfied for each UI. For example, if the minimum input pulse width is violated when satisfying TdiVW(min), VdiVW(max), and minimum slew rate limits, then either TdiVW(min) or minimum slew rates would have to be increased to the point where the minimum input pulse width would no longer be violated.

17.3 Command, Control, and Address Setup, Hold, and Derating

The total tIS (setup time) and tIH (hold time) required is calculated to account for slew rate variation by adding the data sheet tIS (base) values, the VIL(AC)/VIH(AC) points, and tIH (base) values, the VIL(DC)/VIH(DC) points; to the ΔtIS and ΔtIH derating values, respectively. The base values are derived with single-end signals at 1V/ns and differential clock at 2V/ns. Example: tIS (total setup time) = tIS (base) + ΔtIS .

For a valid transition, the input signal has to remain above/below VIH(AC)/VIL(AC) for the time defined by tVAC.

Although the total setup time for slow slew rates might be negative (for example, a valid input signal will not have reached VIH(AC)/VIL(AC) at the time of the rising clock transition), a valid input signal is still required to complete the transition and to reach VIH(AC)/VIL(AC). For slew rates that fall between the values listed in derating tables, the derating values may be obtained by linear interpolation.

Setup (tIS) nominal slew rate for a rising signal is defined as the slew rate between the last crossing of VIL(DC)max and the first crossing of VIH(AC)min that does not ring back below VIH(DC)min. Setup (tIS) nominal slew rate for a falling signal is defined as the slew rate between the last crossing of VIH(DC)min and the first crossing of VIL(AC)max that does not ring back above VIL(DC)max. Hold (tIH) nominal slew rate for a rising signal is defined as the slew rate between the last crossing of VIL(DC)max and the first crossing of VIH(AC)min that does not ring back below VIH(DC)min. Hold (tIH) nominal slew rate for a falling signal is defined as the slew rate between the last crossing of VIH(DC)min and the first crossing of VIL(AC)min that does not ring back above VIL(DC)max.

[Table 54] Command, Address, Control Setup and Hold Values

DDR4	1600	1866	2133	2400	2666	Unit	Reference
tIS(base, AC100)	115	100	80	62	-	ps	VIH/L(ac)
tIH(base, DC75)	140	125	105	87	-	ps	VIH/L(dc)
tIS(base, AC 90)	-	-	-	-	55	ps	VIH/L(ac)
tIH(base, DC 65)	-	-	-	-	80	ps	VIH/L(dc)
tIS/tIH @ VREF	215	200	180	162	145	ps	

NOTE :

- 1) Base ac/dc referenced for 1V/ns slew rate and 2 V/ns clock slew rate.
- 2) Values listed are referenced only; applicable limits are defined elsewhere.

[Table 55] Command, Address, Control Input Voltage Values

DDR4	1600	1866	2133	2400	2666	Unit	Reference
VIH.CA(AC)min	100	100	100	100	90	mV	VIH/L(ac)
VIH.CA(DC)min	75	75	75	75	65	mV	VIH/L(dc)
VIL.CA(DC)max	-75	-75	-75	-75	-65	mV	VIH/L(dc)
VIL.CA(AC)max	-100	-100	-100	-100	-90	mV	VIH/L(ac)

NOTE :

- 1) Command, Address, Control input levels relative to VREFCA.
- 2) Values listed are referenced only; applicable limits are defined elsewhere.

[Table 56] Derating values DDR4-1600/1866/2133/2400 tIS/tIH - ac/dc based

ΔtIS, ΔtIH derating in [ps] AC/DC based ¹⁾																	
		CK_t, CK_c Differential Slew Rate															
		10V/ns		8V/ns		6V/ns		4V/ns		3.0V/ns		2.0V/ns		1.5V/ns		1V/ns	
		ΔtIS	ΔtIH	ΔtIS	ΔtIH	ΔtIS	ΔtIH	ΔtIS	ΔtIH	ΔtIS	ΔtIH	ΔtIS	ΔtIH	ΔtIS	ΔtIH	ΔtIS	ΔtIH
CMD, ADDR, CNTL Input Slew rate V/ns	7	76	54	76	55	77	56	79	58	82	60	86	64	94	73	111	89
	6	73	53	74	53	75	54	77	56	79	58	83	63	92	71	108	88
	5	70	50	71	51	72	52	74	54	76	56	80	60	88	68	105	85
	4	65	46	66	47	67	48	69	50	71	52	75	56	83	65	100	81
	3	57	40	57	41	58	42	60	44	63	46	67	50	75	58	92	75
	2	40	28	41	28	42	29	44	31	46	33	50	38	58	46	75	63
	1.5	23	15	24	16	25	17	27	19	29	21	33	25	42	33	58	50
	1	-10	-10	-9	-9	-8	-8	-6	-6	-4	-4	0	0	8	8	25	25
	0.9	-17	-14	-16	-14	-15	-13	-13	-10	-11	-8	-7	-4	1	4	18	21
	0.8	-26	-19	-25	-19	-24	-18	-22	-16	-20	-14	-16	-9	-7	-1	9	16
	0.7	-37	-26	-36	-25	-35	-24	-33	-22	-31	-20	-27	-16	-18	-8	-2	9
	0.6	-52	-35	-51	-34	-50	-33	-48	-31	-46	-29	-42	-25	-33	-17	-17	0
	0.5	-73	-48	-72	-47	-71	-46	-69	-44	-67	-42	-63	-38	-54	-29	-38	-13
0.4	-104	-66	-103	-66	-102	-65	-100	-63	-98	-60	-94	-56	-85	-48	-69	-31	

NOTE :
1) VIH/L(ac) = +/-100mV, VIH/L(dc) = +/-75mV; relative to VREFCA.

[Table 57] Derating values DDR4-2666 tIS/tIH - ac/dc based

ΔtIS, ΔtIH derating in [ps] AC/DC based ¹⁾																	
		CK_t, CK_c Differential Slew Rate															
		10V/ns		8V/ns		6V/ns		4V/ns		3.0V/ns		2.0V/ns		1.5V/ns		1V/ns	
		ΔtIS	ΔtIH	ΔtIS	ΔtIH	ΔtIS	ΔtIH	ΔtIS	ΔtIH	ΔtIS	ΔtIH	ΔtIS	ΔtIH	ΔtIS	ΔtIH	ΔtIS	ΔtIH
CMD, ADDR, CNTL Input Slew rate V/ns	7	TBD	TBD	TBD	TBD	TBD	TBD	TBD	TBD	TBD	TBD	TBD	TBD	TBD	TBD	TBD	TBD
	6	TBD	TBD	TBD	TBD	TBD	TBD	TBD	TBD	TBD	TBD	TBD	TBD	TBD	TBD	TBD	TBD
	5	TBD	TBD	TBD	TBD	TBD	TBD	TBD	TBD	TBD	TBD	TBD	TBD	TBD	TBD	TBD	TBD
	4	TBD	TBD	TBD	TBD	TBD	TBD	TBD	TBD	TBD	TBD	TBD	TBD	TBD	TBD	TBD	TBD
	3	TBD	TBD	TBD	TBD	TBD	TBD	TBD	TBD	TBD	TBD	TBD	TBD	TBD	TBD	TBD	TBD
	2	TBD	TBD	TBD	TBD	TBD	TBD	TBD	TBD	TBD	TBD	TBD	TBD	TBD	TBD	TBD	TBD
	1.5	TBD	TBD	TBD	TBD	TBD	TBD	TBD	TBD	TBD	TBD	TBD	TBD	TBD	TBD	TBD	TBD
	1	TBD	TBD	TBD	TBD	TBD	TBD	TBD	TBD	TBD	TBD	TBD	TBD	TBD	TBD	TBD	TBD
	0.9	TBD	TBD	TBD	TBD	TBD	TBD	TBD	TBD	TBD	TBD	TBD	TBD	TBD	TBD	TBD	TBD
	0.8	TBD	TBD	TBD	TBD	TBD	TBD	TBD	TBD	TBD	TBD	TBD	TBD	TBD	TBD	TBD	TBD
	0.7	TBD	TBD	TBD	TBD	TBD	TBD	TBD	TBD	TBD	TBD	TBD	TBD	TBD	TBD	TBD	TBD
	0.6	TBD	TBD	TBD	TBD	TBD	TBD	TBD	TBD	TBD	TBD	TBD	TBD	TBD	TBD	TBD	TBD
	0.5	TBD	TBD	TBD	TBD	TBD	TBD	TBD	TBD	TBD	TBD	TBD	TBD	TBD	TBD	TBD	TBD
0.4	TBD	TBD	TBD	TBD	TBD	TBD	TBD	TBD	TBD	TBD	TBD	TBD	TBD	TBD	TBD	TBD	

NOTE :
1) VIH/L(ac) = +/-tbd mV, VIH/L(dc) = +/- tbd mV; relative to VREFCA

17.4 DDR4 Function Matrix

DDR4 SDRAM has several features supported by ORG and also by Speed. The following Table is the summary of the features.

[Table 58] Function Matrix (By ORG. V:Supported, Blank:Not supported)

Functions	x4	x8	NOTE
Write Leveling	V	V	
Temperature controlled Refresh	V	V	
Low Power Auto Self Refresh	V	V	
Fine Granularity Refresh	V	V	
Multi Purpose Register	V	V	
Data Mask		V	
Data Bus Inversion		V	
TDQS		V	
ZQ calibration	V	V	
DQ Vref Training	V	V	
Per DRAM Addressability	V	V	
Mode Register Readout	V	V	
CAL	V	V	
WRITE CRC	V	V	
CA Parity	V	V	
Control Gear Down Mode	V	V	
Programmable Preamble	V	V	
Maximum Power Down Mode	V	V	
Boundary Scan Mode			
Additive Latency	V	V	
3DS	V	V	

[Table 59] Function Matrix (By Speed. V:Supported, Blank:Not supported)

Functions	DLL Off mode	DLL On mode			NOTE
	equal or slower than 250Mbps	1600/1866/2133 Mbps	2400Mbps	2666Mbps	
Write Leveling	V	V	V	V	
Temperature controlled Refresh	V	V	V	V	
Low Power Auto Self Refresh	V	V	V	V	
Fine Granularity Refresh	V	V	V	V	
Multi Purpose Register	V	V	V	V	
Data Mask	V	V	V	V	
Data Bus Inversion	V	V	V	V	
TDQS		V	V	V	
ZQ calibration	V	V	V	V	
DQ Vref Training	V	V	V	V	
Per DRAM Addressability		V	V	V	
Mode Register Readout	V	V	V	V	
CAL		V	V	V	
WRITE CRC		V	V	V	
CA Parity		V	V	V	
Control Gear Down Mode				V	
Programmable Preamble (= 2tCK)			V	V	
Maximum Power Down Mode		V	V	V	
Boundary Scan Mode	V	V	V	V	
3DS	V	V	V	V	

18. PHYSICAL DIMENSIONS

18.1 1Gx8 based 1Gx72 Module (1 Rank) - M391A1K43BB1

Units : Millimeters

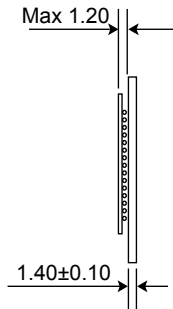
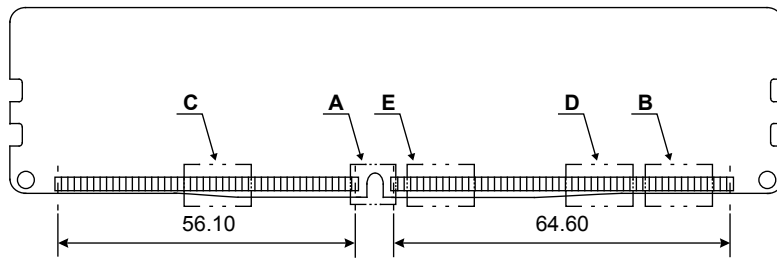
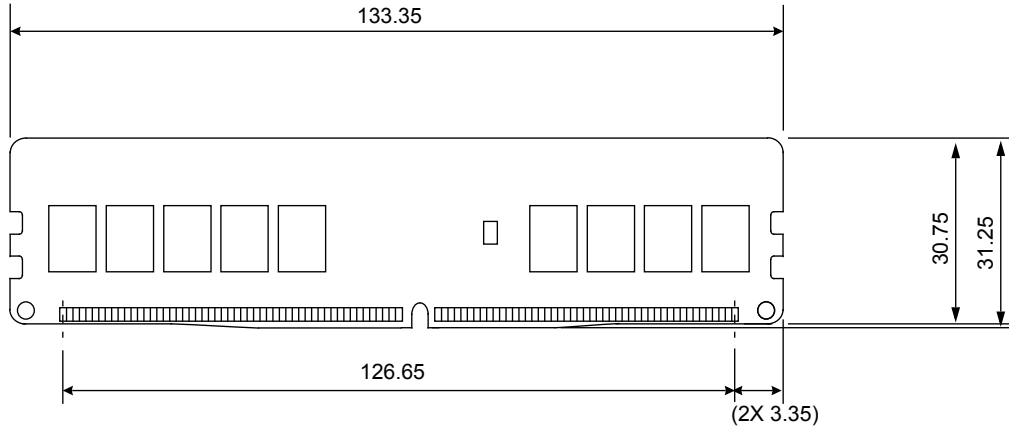

NOTE : Passive devices are in the back side only for M391A1K43BB1

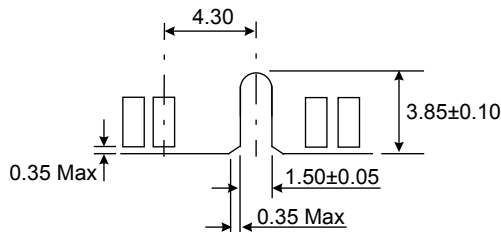

Detail A

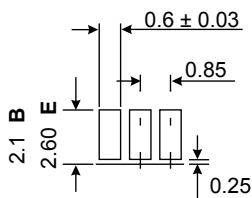

Detail B,E

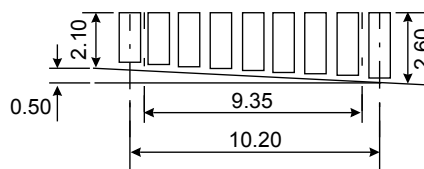

Detail C

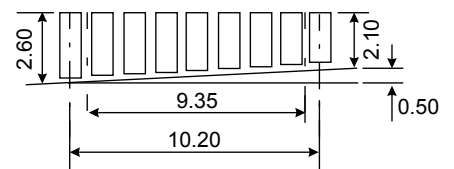

Detail D

The used device is 1G x8 DDR4 SDRAM, FBGA.
 DDR4 SDRAM Part NO : K4A8G085WB-BC**

NOTE :
 1) Tolerances on all dimensions ±0.15 unless otherwise specified.

18.2 1Gx8 based 1Gx72 Module (1 Rank) - M391A1K43BB2

Units : Millimeters

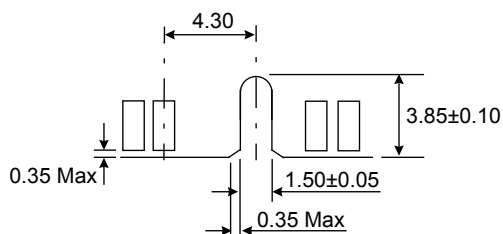
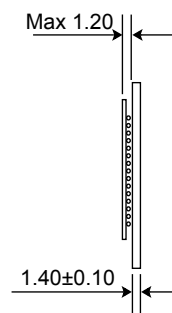
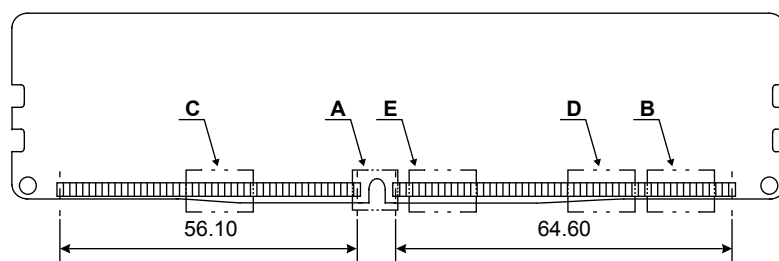
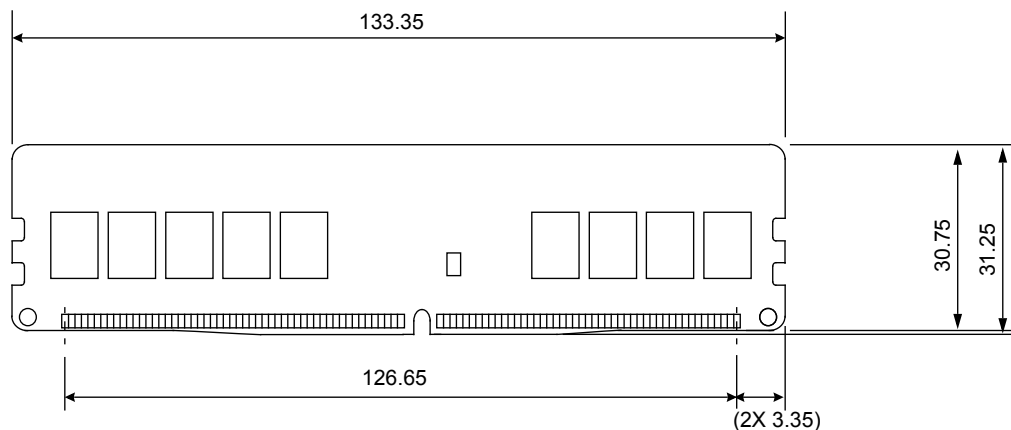

Detail A

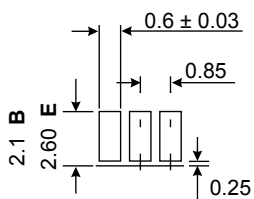

Detail B,E

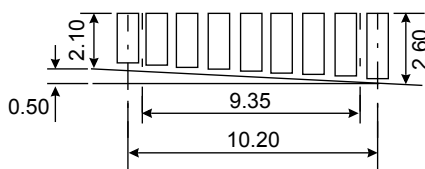

Detail C

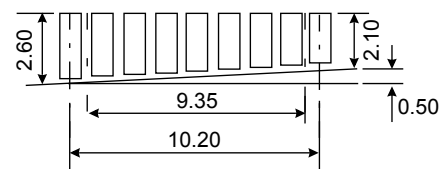

Detail D

The used device is 1G x8 DDR4 SDRAM, FBGA.
 DDR4 SDRAM Part NO : K4A8G085WB-BC**

NOTE :
 1) Tolerances on all dimensions ±0.15 unless otherwise specified.

18.3 1Gx8 based 2Gx72 Module (2 Ranks) - M391A2K43BB1

Units : Millimeters

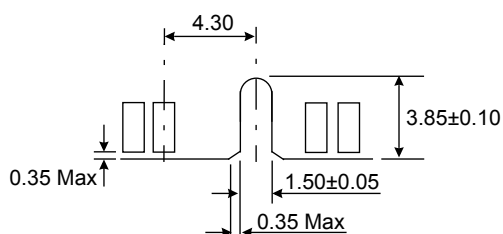
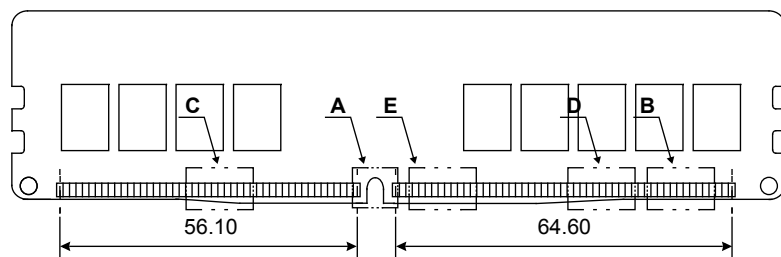
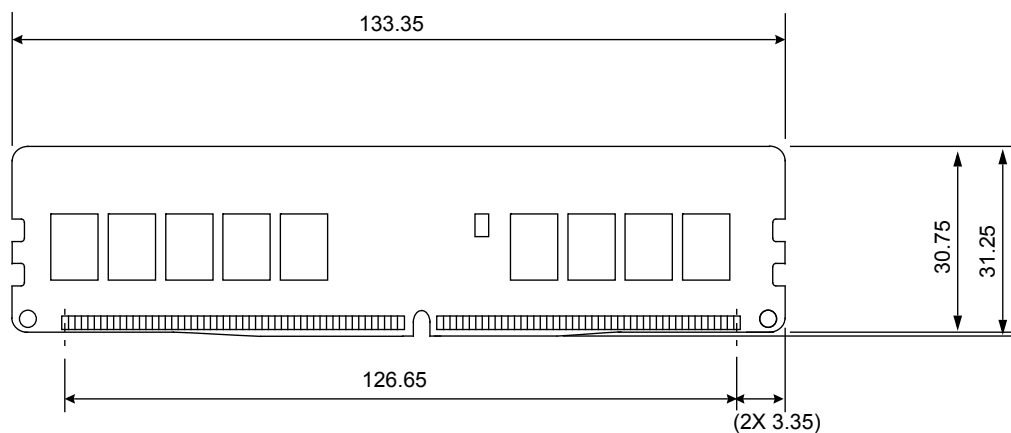

Detail A

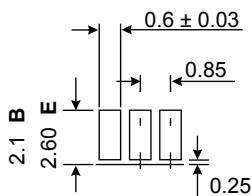
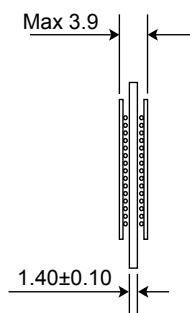

Detail B,E

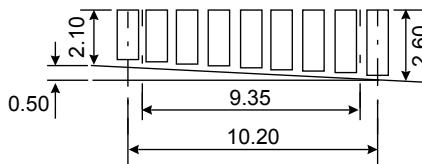

Detail C

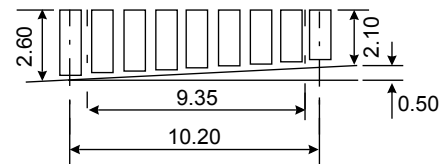

Detail D

The used device is 1G x8 DDR4 SDRAM, FBGA.
 DDR4 SDRAM Part NO : K4A8G085WB-BC**

NOTE :
 1) Tolerances on all dimensions ±0.15 unless otherwise specified.