



**SNR-VP-51**  
**IP Phone User Manual**

## Contents

1. Overview .....	5
1.1. Introduction.....	5
1.2. Features .....	6
1.3. Keypad.....	8
1.4. Icons introduction.....	10
2. Installation .....	11
2.1. Check package contents.....	11
2.2. Connection diagram.....	11
2.3. Installation Steps.....	12
3. Functions.....	13
3.1. Make a call .....	13
3.1.1. Call devices .....	13
3.1.2. Call Methods .....	13
3.2. Answer a call .....	13
3.3. Mute .....	14
3.4. Call Hold/Resume .....	14
3.5. Do Not Disturbed (DND).....	14
3.6. Call Waiting .....	14
3.7. Call Forward.....	15
3.8. Call Transfer.....	15
3.8.1. Blind Transfer .....	15
3.8.2. Consultation Transfer .....	16
3.9. Conference .....	16
3.10. Call Park.....	17
3.11. Pickup .....	17
3.11.1. Specified Pickup .....	17
3.11.2. Group Pickup .....	18
3.12. Speed Dial .....	18
3.13. Auto-redial.....	18
3.14. Hot line .....	18
3.15. Intercom .....	19
3.16. HotDesking .....	19
3.16.1. Set the HotDesking Key.....	20
3.16.2. HotDesking Feature: .....	20
3.17. XML Browser.....	20
3.18. Keypad Lock .....	20
3.19. Hoteling .....	21
3.20. Application.....	22
3.20.1. Text Message .....	22
3.20.2. Voice Message .....	24

4.	Settings .....	26
4.1.	Basic Settings.....	26
4.1.1.	Language.....	26
4.1.2.	Date & Time.....	26
4.1.3.	Backlight .....	27
4.1.4.	Password Setting .....	27
4.2.	Sound Settings.....	27
4.2.1.	Phone Volume .....	27
4.2.2.	Ring Tones.....	27
4.3.	Phone Book .....	28
4.3.1.	Local Phone Book .....	28
4.3.2.	Blacklists .....	29
4.3.3.	Remote Phone Book.....	29
4.4.	History Management.....	29
4.5.	System Customizations .....	30
4.5.1.	Programmable keys.....	30
4.5.2.	SIP Account management.....	30
4.6.	Basic Network Settings.....	31
4.7.	WebServer .....	31
4.8.	Reset to Factory .....	32
4.9.	Reboot .....	32
5.	WEBInterface .....	32
5.1.	Status->Basic.....	33
5.2.	Account->Basic .....	35
5.3.	Account->Advanced.....	37
5.4.	Network->Basic.....	40
5.5.	Network->Advanced .....	40
5.6.	Phone ->Time/Lang.....	43
5.7.	Phone->Preference.....	45
5.8.	Phone->Call Feature .....	46
5.9.	Phone->Voice .....	49
5.10.	Phone->Key/Display .....	51
5.11.	Phone->Ring tones.....	52
5.12.	Phone->Tones.....	53
5.13.	Phone->Dial Plan->Replace Rule.....	54
5.14.	Phone ->Dial Plan->Dial Now .....	55
5.15.	Phone ->Action URL.....	56
5.16.	PhoneBook->Local Phone Book.....	58
5.17.	Phone Book->Remote Phone Book .....	59
5.18.	Phone Book->Call log.....	60
5.19.	Phone Book->LDAP .....	61
5.20.	Phone Book->BroadSoft .....	62
5.21.	Upgrade->Basic .....	63
5.22.	Upgrade->Advanced .....	64

5.23.	Security->Basic .....	66
5.24.	Security->Advanced.....	67
6.	Troubleshooting .....	68
7.	Appendix:TimeZones.....	69

# 1. Overview

## 1.1. Introduction



The SNR-VP-51 is a featured one-line IP phone with full duplex hands-free speakerphone. It can be directly connected to an Internet Telephony Service Provider or to an IP PBX.

Based on the SIP standard, the SNR-VP-51 has been tested to ensure comprehensive interoperability with equipment from VoIP infrastructure leaders enabling service providers to quickly roll-out competitive, feature rich services to their customers.

SNR-VP-51 is very easy to understand, configure, and deploy. The web interface is designed to provide a clean and user-friendly configuration window.

## 1.2. Features

### ➤ Highlights

- HD Voice
- 2.6" 132x64 Graphical LCD with Backlight
- Support 3-way Conference
- Support PoE
- Full Compatible with Asterisk, BroadSoft Platform

### ➤ Phone Features

- 1 Line (support 1 SIP account)
- Support call waiting, call forwarding, call transfer
- Call on hold, mute, auto-answer, redial
- Phonebook (500 groups), Blacklist (100 groups), call logs (100 entries)
- 3-Way Conference
- DND (Do Not Disturb)
- Volume adjustable, ring tones selectable
- 5 Remote Phone Book URL supported
- Call Pickup/Group Call Pickup
- Speed Dial
- Intercom
- Daylight Saving
- Network Packet Capture
- Country Ringtone Signal
- Direct IP call
- Auto Answer
- Hotline
- XML Browser
- Hot Desking
- Keypad Lock
- Action URL/URI
- Multi-Languages: Default: English and Simple Chinese

### ➤ IP-PBX Features

- Dial Plan
- SMS, voicemail, MWI message Notification

- Wideband Codec: G.722
- Narrowband Codec: G723\_53, G723\_63, G726\_32 , PCMA, PCMU , G.729
- VAD, CNG , Echo Cancellor
- Full-Duplex Speakerphone

➤ **Network Features**

- SIP V1(RFC2543), V2(RFC3261)
- Static IP/DHCP for IP configuration
- 3 DTMF modes: In-Band, RFC2833, SIP INFO
- HTTP/HTTPS Web Server for Management
- NTP for Auto Time Setting
- TFTP/FTP/HTTP/HTTPS Protocols
- 802.1Q VLAN

➤ **Administration Features**

- Auto provisioning using FTP/TFTP/HTTP/HTTPS/PnP
- Dial through IP PBX Using Phone Number
- Dial through IP PBX Using URL Address
- Configuration Managements with Web, keypad on the phone, and Auto Provisioning
- SNMP
- TR069

➤ **Security Features**



- Support HTTPS (SSL)
- Support SRTP for Voice Data Encryption
- Support Login for Administration
- SIP Over TLS

## 1.3. Keypad





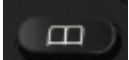

- Keypad, LED, and function key definitions



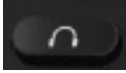

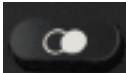
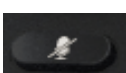

- Keypad Description

Key	Key name	Function Description
	Navigation	Assists you in selecting an item that you want to process under the menu by pressing the Up, Down, Right or Left key. Press the OK key to save.
	Soft keys 1/2/ 3/4	Key combination includes functions such as History/Favorites/Redial/CallReturn/HotDesking/ XML Browser/DND/Menu/MSG/Status/Book/FWD/PickUp/Group PickUp/Intercom/Speed Dial/and so on.
	Home	Back to the Home page
	Book	View Local Phone Book/Blacklist/Remote Phone Book





	Headset	Use the headset to call out or call in
	Forward	Forward the call to the third party
	Redial	View the Missed Calls, Incoming Calls and Dialed Calls.
	Mute	Press this key in calling mode and you can hear the other side, but the other side cannot hear you.
	Volume -/+	Turn down or turn up the volume by pressing the “-“ key or the “+” key.
	Hand-free	Make the phone into hand-free mode.
	Digital keyboard	Inputting the phone number or DTMF.
	Indicator light	Blinking light indicates there is an incoming call.

➤ **Panel descriptions**

Port	Port name	Description
	Power switch	Input: 5V DC 1.2A
	Internet	10/100M Connect it to Network
	PC	10/100M Connect it to PC
	Handset	Port type: RJ-9 connector
	Headset	Port type: RJ-9 connector

## 1.4. Icons introduction

Register success	
Register failure	
Registering	
Deactivated account	
Auto answer	
No disturb	
Always Forward	
Network disconnection	
Ring off	
Headset mode	
New voice message	
New text message	
Missed calls	

## 2. Installation

### 2.1. Check package contents

Please refer to the package list below to check the completeness of package

Name	Quantity
SIP IP Phone unit	1
handset	1
RJ-9 Cable	1
Power Adapter	1
RJ-45 Cable	1
Stand	1
Quick installation guide	1

### 2.2. Connection diagram

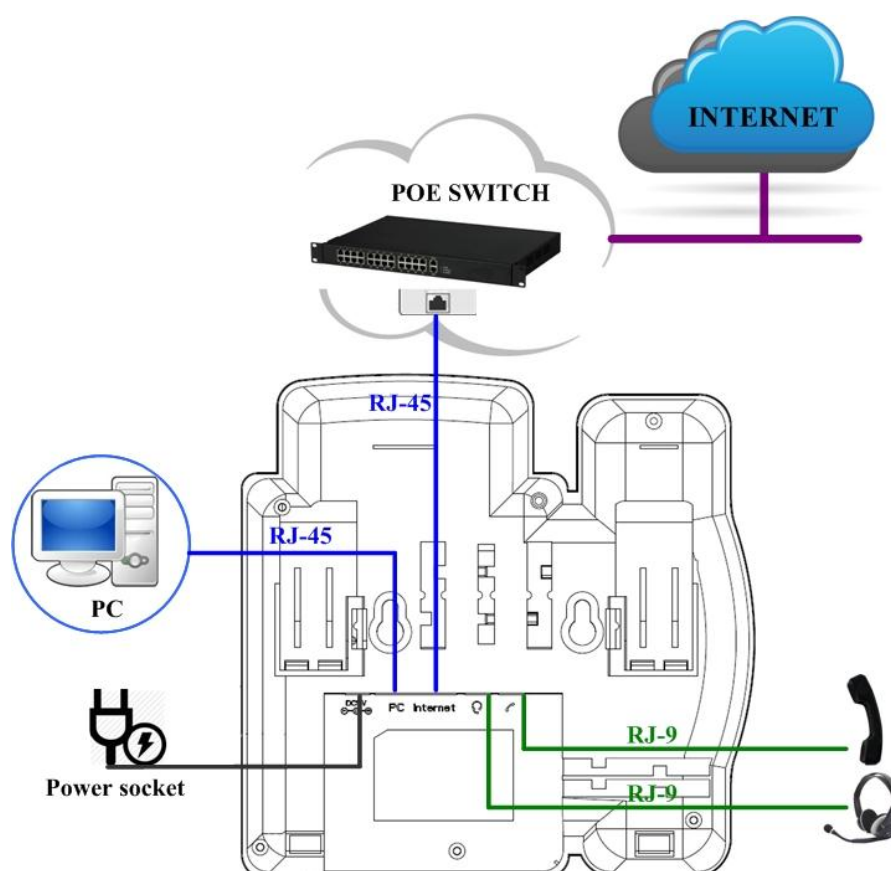

## 2.3. Installation Steps

Step 1 – Connect to the power

Connect the provided power adapter to the Power port and plug the adapter into an available power outlet. The LCD will display “Initializing, Please Wait...”

-----  
Note1: Never use a power adapter other than the one provided with SNR-VP-51

Note2: Only Internet port supports POE.  
-----

Step 2 – Connect to the Internet

Connect one end of the RJ-45 Ethernet cable to the Internet port at the back of the SNR-VP-51 and the other end to wall network jack.

Step 3 – Connect the computer

Connect one end of the RJ-45 Ethernet cable to the PC port at the back of the SNR-VP-51 and the other end to the Ethernet port on your computer.

Step 4 – Configure the device

Launch the web browser on your computer, and enter the IP address of the phone into the address bar. The login screen will appear if the address is correct. Enter the user name and password to log into the web console.



NOTE: Each phone has its own IP address, you can check it by press the OK key on the keyboard when the phone is idle

## 3. Functions

### 3.1. Make a call

#### 3.1.1. Call devices

User can make a phone call via the following methods :

1. Pick up the handset,  icon will be shown on the idle screen.
2. Press the Hand-free key,  icon will be shown on the idle screen.
3. Press the Headset key if the headset is connected to the Headset Port in advance.

The  icon will be shown on the idle screen.

User can also dial the number first, and then choose the method user will use to speak to the other party.

#### 3.1.2. Call Methods

User can press an available line key if there is more than one account, then

1. Dial the number User wants to call.
2. Press History soft key. Use the navigation keys to highlight User choice (press Left/Right key to choose Missed Calls, Incoming Calls and Outgoing Calls).
3. Press the Redial key twice to call the last number called or press Redial key to enter All Calls interface to choose the number to dial out.
4. Press the programmable keys which are set as speed dial key. Then press the Send key or Dial soft key to make the call if necessary.

### 3.2. Answer a call

1. If User is not on another phone call, lift the handset to use, or press the Speaker key/



Answer soft key to answer using the speaker phone, or press the headset key to answer the headset.

2. If User is on another phone call, press the answer soft key to answer new incoming and

hold the current talking. During the conversation, User can alternate between Headset, Handset and Hand-free by pressing the corresponding keys.

Note: The  will flash during the Incoming interface

### **3.3. Mute**

You can press the Mute key  to make the user NOT be heard by the other party, but User can hear the other party. Icon  will be shown on the LCD, and press the Mute key again to recover.

### **3.4. Call Hold/Resume**

1. Press the Hold button or Hold soft key to put User active call on hold.
2. If there is only one call on hold, press the hold soft key to retrieve the call.
3. If there is more than one call on hold, press the line button, and the Up/Down button to highlight the call, and then press the Resume button to retrieve the call.

### **3.5. Do Not Disturbed (DND)**

If you enable DND mode, the phone will reject to answer all calls automatically and play busy tone, the UI will present missed calls at the same time.

### **3.6. Call Waiting**

To configure Call Waiting via Phone interface:

1. Press Menu -->Features-->Call Waiting-->Enter ;
2. Use the Left or Right key to activate or deactivate call waiting.
3. Then press the Save key to save the changes.

## 3.7. Call Forward

You can set the static forward to transfer all the incoming calls to specified number; Also you can use dynamic forward to transfer all the incoming calls forward to the number inputted when the phone is ringing.

Forward: Enable call forward feature, Options as follows :

- Always forward: All the incoming calls will be transferred unconditionally to specified number.
- Busy Forward: The incoming calls will be transferred to specified number when the phone is busy.
- No answer Forward: The incoming calls will be transferred to the specified number when the ring tone is time out without answer.

To configure Call Forward via Phone interface:

1. Press Menu -->Features-->Call Forward-->Enter, or just press FWD key to enter Call Forward interface;
2. There are 3 options: Always, Busy, and No Answer.
3. If User chooses one of them, enter the phone number User wants to forward to receiving party. Press Save to save the changes.

## 3.8. Call Transfer

You can use the following two ways to transfer talking to the other party :

- Blind Transfer: Transfer talking directly to the other party without any negotiation.
- Consultation Transfer: Transfer talking to the other person involved after the other person involved answer the incoming and with consultation.

### 3.8.1. Blind Transfer

1. Press the Trans soft key during the talking;
2. Enter the Trans number interface, and then Input the number you will transfer to;

3. Press the FWD key or the Trans soft key to transfer the hold talking to the number you want to transfer to;

4. Return to the Idle automatically ;

Note: The UI will display Hold status interface when the number you want to transfer to is not existed.

### **3.8.2. Consultation Transfer**

1. Press the Trans soft key to enter the number you want to transfer to during the talking; Input the number you want to transfer to ;

2. Press the OK key on the phone keyboard or the Dial key to make a call ;

3. Press the Trans soft key to finish transfer after the other person involved answer the incoming and with consultation; You can finish transfer via putting down the handset or press the Cancel soft key to cancel transfer if you currently use handset to make or answer a call.

## **3.9. Conference**

You can use the Local conference feature to hold a 3-way conference by pressing the Conference soft key to invite the current talking line and the line on hold to attend the conference.

The Local conference feature of IP phone SNR-VP-51 can invite two parties at most to attend conference. The conference type of IP phone SNR-VP-51 is Local conference with default.

1. Create talking with first party;

2. Press the New soft key to create a new talking;

3. Press the Back soft key of dial interface to hold talking with first party.

4. Input the number of second party and press the OK key on the phone keyboard or the Dial key or the Send soft key to make a call; When the second party answer your call, inquire whether they want to attend conference ;

5. Press the Conference soft key to start 3-way conference.

6. Press the Split soft key to split to two lines standalone talking, then this two parties talking are under Hold status:



7. Press the Resume soft key to resume the current talking:

8. Press the Cancel soft key or the  key to cancel the conference talking and return to Idle :

## 3.10.Call Park

You can use Call Park feature to park the current talking, and then resume the Parking talking in another phone (For example, in another phone of another office or conference). Press the Call Park key to park the current talking during the talking. If success, you will hear voice announce or see the reserved extension number on the phone LCD. Dial the reserved extension number in another phone to resume the Parking talking.

Note: Not all servers can support Call Park feature.

To configure Call Park via Phone interface:

PATH: Press Menu-->Features-->Call Park-->Press Left or Right key or Switch soft key to enable Call Park--> Press the Down key to set Target number-->Press the Down key to set Account-->Press the Save soft key to save;

## 3.11.Pickup

You can use pickup to answer other users' incoming call. The IP phone SNR-VP-51 supports specified pickup and group pickup.

Note: Press the group pickup only to answer line 1 incoming call if there are many lines incoming calls in group.

### 3.11.1. Specified Pickup

Specified pickup can answer specified user's incoming calls

1. Set specified pickup key via phone interface,

PATH: Press Menu-->Features-->Programmable keys-->Soft Keys-->PickUp-->Press Down key to set label/Value--> Save soft key;

2. Use specified pickup feature

When the user of specified pickup number is off or busy, you can press the pickup key to answer incoming call.

### **3.11.2. Group Pickup**

Group pickup can answer group's user incoming calls. Group pickup needs to set group members.

1. Set group pickup via phone interface

PATH: Press Menu-->Features-->Programmable keys-->Soft Keys-->Group Pickup -->Press Down key to set label/Value/Account--> Save soft key;

2. Use group pickup feature

When anyone in group receives an incoming call, you can press the group pickup key to answer.

### **3.12.Speed Dial**

You can use the Speed Dial feature to dial the specified contact speedily

PATH: Press Menu-->Features-->Programmable keys-->Soft Keys-->Speed Dial -->Press Down key to set label/Value/Account--> Save soft key;

### **3.13.Auto-redial**

When hang-up by the other party, call failure during the calling, the phone will enter the auto-redial screen, Press OK for redial now or wait for the timeout to cancel Auto-redial.

To configure Auto Redial via Phone interface:

1. Press Menu -->Features-->Auto Redial-->Enter, ;
2. Use the Left or Right key to activate or deactivate Auto Redial.
3. Use the Up or Down key to configure Interval and Times;
4. Then press the Save key to save the changes.

### **3.14.Hot line**

The Hot line refers to the number you often dial. You can set hot lines in the phone, the phone will dial the hot line number automatically when you pick up the handset, press the hand-free or the account key. Also you can set the timeout of dialing the hot line number, and then the phone will dial the hot line number automatically after the timeout.

To configure Hot line via Phone interface:

1. Press Menu -->Features-->Hot line-->Enter
2. Use the Left or Right key to activate or deactivate Hot line.
3. Use the Up or Down key to configure Number and Timeout;
4. Then press the Save key to save the changes.

### 3.15.Intercom

To configure Intercom via Phone interface:

PATH: Press Menu-->Features-->Programmable keys-->Soft Keys-->Intercom--> Press Down key to set label/Value/Account--> Save soft key;

1. Press the Intercom key when the phone is available. The phone will connect the extension number of remote user automatically .
2. Press the Intercom key or the Back soft key to end the intercom.
3. Answer the intercom incoming calling
4. In default situation, the IP phone SNR-VP-51 will answer the intercom incoming calling automatically and make a noise. You can set the phone to enable silent mode when picking up the intercom call so that the other will not hear you .

The features of intercom :

Intercom Feature	Note
Allow Intercom	Enable or disable Auto-receive intercom
Intercom Mute	Enable or disable Mute mode after receiving intercom incoming

### 3.16.HotDesking

In some working place, the people are always walking around. HotDesking feature will make the staffs login his account on any computer in the company. In some public places, the working people is not fixed, anyone can use HotDesking for logging his account, and setting the phones to the familiar mode. Such as the remote function of the computer.

### **3.16.1.Set the HotDesking Key**

To configure Intercom via Phone interface:

PATH: Press Menu-->Features-->Programmable keys-->Soft Keys-->HotDesking--> Press Down key to set label--> Save soft key;

### **3.16.2.HotDesking Feature :**

1. After setting the HotDesking on Soft-key, back to the idle screen:
2. Pressing the HotDesking, and enter the HotDesking screen:
3. If you press clear on the screen, the phone will begin to clear the information stored on the phone :
4. After clear the setting, the phone will enter the account setting screen :
5. After entering the account information, back to the home screen, and begin to use the new account.

## **3.17.XML Browser**

XML Browser allows the users to develop and deploy custom services. Users need to pre-configure a custom service functions on the server, such as news, weather report, stock information. The user receives and displays the service information on the IP phone from the server, and all service information are transmitted in XML object.

To configure XML Browser via Phone interface:

PATH: Press Menu-->Features-->Programmable keys-->Soft Keys/Function keys-->XML Browser--> Press Down key to set Label/Value--> Save soft key;

## **3.18.Keypad Lock**

You can lock the keypad of your phone temporarily when you are not using it. This feature helps to protect your phone from unauthorized use.

Keypad Lock can be set to ON or OFF, how long to enable this function during the phone is idle

and you can choose to lock the function keys or all keys. And this function can only be configured through the web UI, please refer to the web interface for the details.

- Function Keys: The function keys are locked. You cannot use the SOFT KEYS, NAVIGATION KEYS, FUNCTION KEYS until unlocked.
- All Keys: All keys are locked.

### 3.19.Hoteling

Hoteling function enables the customer to login the own sip account on the Host ip phone, after login to the phone, the customer can use his own guest account on the host ip phone.

Note: Hoteling is supported by Broadsoft platform, Please consult your administrator further information.

#### Application :

##### 1、 Remote Work

- 1.1. User goes to the branch office, his own extension number is 4723 in head office;
- 1.2. User uses the remote work function, find a idle host ip phone;
- 1.3. User can login the extension number 4723 on this host ip phone, to call in and out using his own extension number.

##### 2、 Work on different time division

- 2.1. Users A and B work on different time division at a same table with a same host ip phone, their extension numbers are 4722 and 4723.
- 2.2. A logs the extension number 4722 in the morning, logout after leave.
- 2.3. B logs the extension number 4723 in the evening, using the number 4723 to call in and out, logout after leave.



The host ip phone number is 2404984721

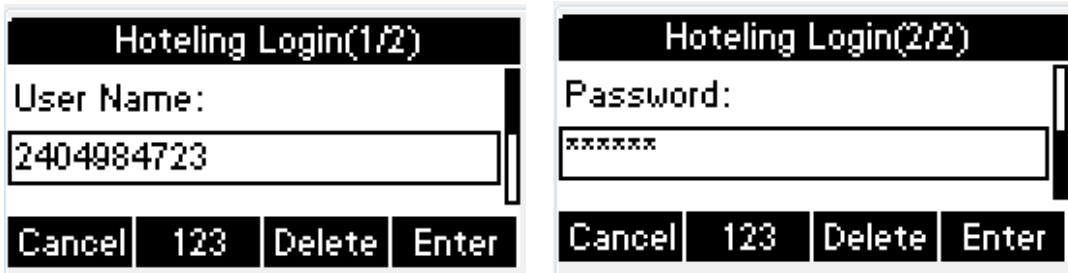

Press GuestIn softkey to login the extension number 4723 and password

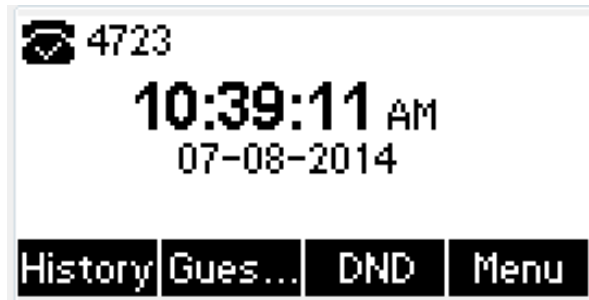

The extension number 4723 is ready for use

## 3.20.Application

### 3.20.1. Text Message

The IP phone SNR-VP-51 can send and answer text message. The phone will make a “Du” sound and present “N piece of new message” on the LCD( For example: 1 new message), and a twinkling message icon will appear.

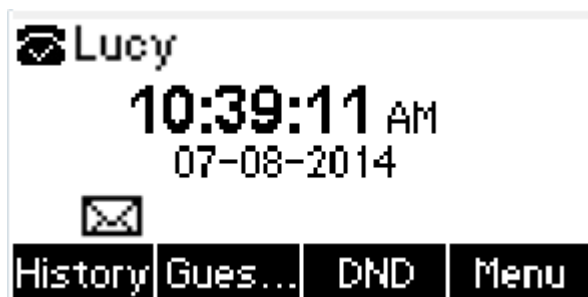

Note: Not all servers support message feature.

### Read Text Message

1. Access Menu->Message->Text Message-> In box
2. Press the OK key on the phone keyboard or the Enter soft key to enter the Text Message interface, Press the OK key on the phone keyboard or the Enter soft key to enter the in-box

interface.

3. Select the message you will read and Press the OK key on the phone keyboard or the Enter soft key to read.

## Send Text Message

1. In the Idle, press the Menu soft key
2. In the mail menu interface, press the Down key on the phone keyboard to select Message, press the OK key on the phone keyboard or the Enter soft key to enter Message interface. :
3. In the Text Message interface, select “New Message”; Press the OK key on the phone keyboard or the Enter soft key to enter new message and edit it, press the “abc” soft key to switch the input methods :
4. Press the OK key on the phone keyboard or the Send soft key to send message;
5. Press the Left or Right key on the phone keyboard or the Switch soft key to switch to the relevant addresser. :

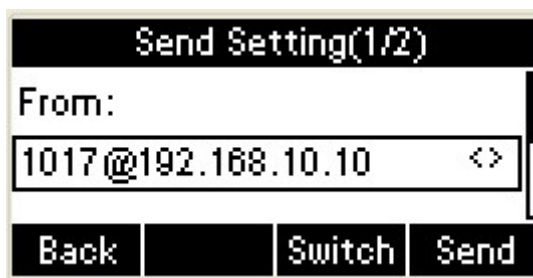

6. Input the number of addresser :

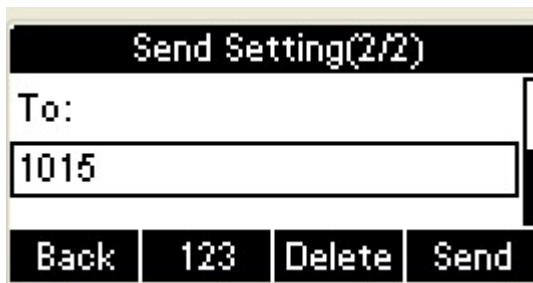

7. Press the Send soft key to send message.

## Delete Text Message

1. In the Idle, press the Menu soft key
2. Press the main menu interface, Press the Down key on the phone keyboard to select message, Press the OK key on the phone keyboard or the Enter soft key to enter the Message interface :
3. In the Text Message interface, press the Down key on the phone keyboard to select in-box :
4. Press the OK key on the phone keyboard or the Enter soft key to enter the in-box interface :
5. Select the message you want to delete and press the Delete soft key :

6. Delete all the text messages in the in-box. Press the Delete soft key and select “Delete All”, press the OK soft key then all the messages in the in-box will be deleted:

### 3.20.2.Voice Message

The IP phone SNR-VP-51 can send or answer voice message. The phone will make a “Du Du” sound, the LED light of message flashes green, and the LCD presents “New Voice Message” on the LCD with a twinkling voice message icon.

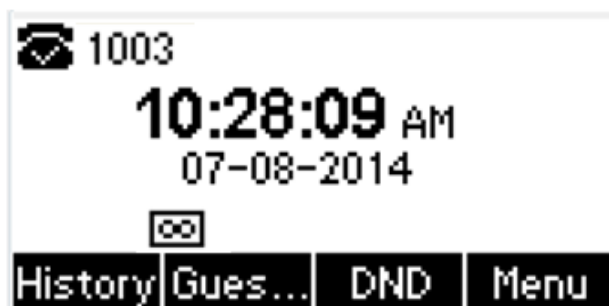

Note: Not all servers support voice message.

#### Voice Message

You can leave a message when the user who you call is busy or unavailable. Leave a message according to the voice prompt of server, and then hang up after leaving the message.

Set Visit account number of voice message via phone interface.

1. In the Idle, press the Menu soft key :
2. In the Idle, press the Down key on the phone keyboard to select message, press the OK key on the phone keyboard or the Enter soft key to enter the Message interface.
3. In the Message interface, press the Down key on the phone keyboard to select the voice message, press the OK key on the phone keyboard or the Enter soft key to enter the Voice Message interface.
4. Select the Voice Message Setting :
5. Press the OK key on the phone keyboard or the Enter soft key to set account 1, input the Visit account number of voice message ( For example: \*97), press 123 soft key to switch the input methods:



6. Press the OK key on the phone keyboard or the Save soft key to save and return to message interface.



### Check voice message

1. Press the Message key or the Connect soft key to call the Visit account number of voice message.

2. Check voice message according to voice prompt.

- Set the Visit account number of voice message first before check voice message.

The LED light of Message will darken after all the voice messages checked.

3. Check voice message via phone interface

- Access Menu-> Message->Voice Message-> New Message. The LCD displays new messages and old messages of every account.

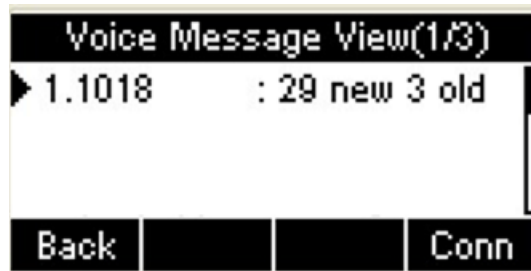

- 2. Select the account you will check and press the Connect soft key to check voice message



# 4. Settings

## 4.1. Basic Settings

### 4.1.1. Language

You can change the language through below method:

Press Menu -> Settings -> Basic Setting -> Language

### 4.1.2. Date & Time

1. The IP phone displays Time and Date in Idle status. You can set the Time and Date obtain from SNTP server automatically or you can set the time and date manually.

2. Set SNTP via phone interface: Access Menu -> Settings -> Basic Setting -> Date & Time -> SNTP Setting.

3. To set the date & time format via the phone interface, access Menu -> Settings -> Basic Setting -> Date & Time -> Format Setting:

- Access the Time Format in Format Setting interface, then press the Left or Right key on the phone keyboard, or the Switch soft key to select the time format (12Hour or 24Hour).
- In the Date & Time Format interface, press the Up or Down key on the phone keyboard to access the Date Format. Press the Left or Right key on the phone keyboard or the Switch soft key to select the date format to process setting.
- The phone supports four Date formats. The selected date format will appear in the Idle. For example, if the time was "2013-09-13", the date formats in the menu and the corresponding formats displayed in the Idle as follows:

Date Format	e.g.(2013-09-13)
YYYY-MM-DD	2013-09-13
YYYY/MM/DD	2013/09/13
DD-MM-YYYY	13-09-2013
DD/MM/YYYY	13/09/2013

### **4.1.3. Backlight**

Set the screen backlight level and duration of backlight

Press Menu -> Settings -> Basic Setting ->Backlight

### **4.1.4. Password Setting**

This function is to set into the advanced Settings password

Press Menu -> Settings -> Advanced Setting ->Password Setting

A dialog box "Enter Password:" appears, enter the password: admin (default), then press the OK key on the phone keyboard, input the currently password, the new password, then confirm new password to modify the current password.

## **4.2. Sound Settings**

### **4.2.1. Phone Volume**

1. The Volume key can be used to adjust the volume of handset, hand-free or headset during a call. Also, the key can be used to adjust the ring tones volume in the Idle mode.

2. Adjust the volume via the phone interface; access Menu -> Settings -> Basic Setting -> Phone Volume. In the Volume Setting interface, access the Handset Volume, Hand-free Volume or Headset Volume interface, then press the "+" or "-" soft key, or Left or Right key to adjust the volume. Press the Save soft key to save the operation or press the Back soft key to cancel operation.

### **4.2.2. Ring Tones**

1. The Ring Tone refers to incoming ring tone, which reminds the user that new call is coming with the phone. The IP phone SNR-VP-51 supports phone ring tone to distinguish the incomings from other near phones' ring tone; At the same time, the IP phone SNR-VP-51 also support setting specific incoming ring tone for contacts.

2. To set the ring tone via the phone interface, access Menu -> Settings -> Basic Setting ->

Ring Tones.

## **4.3. Phone Book**

### **4.3.1. Local Phone Book**

The Local Phone Book is used for storing the contacts names and number. The SNR-VP-51 can store up to 500 entries contacts. You can add, edit, delete, search, or call any contact from the Local Phone Book.

#### **4.3.1.1.1.Add contacts manually :**

Add contacts manually from the Local phone book via Phone interface:  
Press Phone book -> Local phone book -> Add to Contacts.

Select the relevant group ( For example: contacts) and Press the OK key on the phone keyboard or the Enter soft key in the UI to enter All Contacts :

1. Press the Add soft key to enter the Add Contact interface :
2. Input name in the relevant area :
3. Press the Down key on the phone keyboard to input the office number in the relevant area :
4. Press the Down key on the phone keyboard to input mobile number in the relevant area :
5. Press the Down key on the phone keyboard to input other number in the relevant area :
6. Press the Down key on the phone keyboard to enter Account selection; Press the Left or Right key on the phone keyboard or the Switch soft key to select the relevant account, if Auto selected, the phone will select the current available account automatically when the contact called from Local phone book.

#### **4.3.1.1.2.ADD contact from All Calls History :**

Add contact from All Calls History in the phone interface:

1. Press the History soft key;
2. Press the Up or Down key on the phone keyboard to select the contact you want to add;
3. Press the Option soft key to add to contacts.

### 4.3.1.1.3. Search Contacts

1. Press the Book soft key in the Idle interface to enter the Phone Book menu :
2. Select the Local Phone Book, Press the OK key on the phone keyboard or the Enter soft key to enter the Local Phone Book :
3. Press the Search soft key to search contacts :
4. Input keywords such as name, any character of number or whole phone number, press the Search soft key or the OK key to enter the Search Contacts interface.

### 4.3.2. Blacklists

100 Blacklists contacts are available with SNR-VP-51 IP phone. You can add, edit, delete, search or call contact. The phone will reject to answer automatically within the blacklists contacts' incoming call.

PATH: Press Phone book -> Blacklist -> Add.

### 4.3.3. Remote Phone Book

1. Access the remote phone book, add the contacts to the local phone book from the remote phone book or make calls from the remote phone book. 5 URLs of remote phone book are available to set.
2. Set the remote phone book via web interface :
3. Access Book-> Remote Phone Book.
4. Input URL of phone book.
5. Input the phone book name.
6. Click the Submit soft key to submit.
7. Access the remote phone book via phone interface :
8. Access Book->Remote phone book.
9. Select the relevant Remote Group and press the Enter soft key. The phone will load the remote group information, and the LCD will display the contacts of this remote group.
10. Press the  key or the Back soft key to unlink.
11. Press the Book soft key to enter the Phone Book Menu :

## 4.4. History Management

The History management of IP phone SNR-VP-51 contains dialed calls, received calls, missed calls and forwarded calls and support 100 logs storage at most. You can check the history,

make calls from the calls history and delete the calls history .

1. Press the History key, the LCD will display all the recent calls ;
2. Press the Left or Right key on the phone keyboard to switch the lists of All Calls, Dialed Calls, Received Calls, Missed Calls and Forwarded Calls ;
3. Press the Up or Down key on the phone keyboard to select the log ;
- Press the Option soft key and select the detail. The LCD will display the detailed information of this log; Press the Dial soft key, to make a call from the History;
- Press the Option soft key to add to contacts(Move to Blacklists ) from the History;
- Press the Delete soft key to delete calls log from the History;
- Press the Option soft key to select “Delete all” to delete all the calls log from the History

## **4.5. System Customizations**

### **4.5.1. Programmable keys**

1. Press the Menu soft key in the Idle interface, access Menu->Features-> Programmable keys ;
2. Select the programmable key you will set and press the Enter soft key ;
3. Select key style in the type area ;
4. Input suitable value in the label area;
5. (Optional) Select the relevant account in the account ID area ;
6. (Optional) Input suitable value in Value blank ;
7. Press the Save soft key to save or the Cancel soft key to cancel.

### **4.5.2. SIP Account management**

#### **4.5.2.1. Register an Account**

Register an account via phone interface :

1. Press the Menu soft key to enter setting interface to select Advanced setting, input password(password: admin) to enter the Account setting ;
2. Press Enter key to enter the account activation status area ;
3. Input the label, display name, register name, account, password and SIP separately ;
4. Press the Save soft key to save, or the Back soft key to cancel ;

#### **4.5.2.2. Disable an Account**

1. Access Menu->Settings->Advanced setting->Account (password: admin).
2. Press Enter key to enter the account activation status area.
3. Select “Disable” in the account active status area.
4. Press the Save soft key to save or the Back soft key to cancel.

## 4.6. Basic Network Settings

Through the Basic Network setting, you can set the IP Phones to get the IP address by three ways : DHCP, static IP and PPPoE.

PATH: Menu -> Settings -> Advanced Setting -> Network

### 4.6.1.DHCP Mode

1. In the Network Settings interface, Press the OK key on the phone keyboard or the Enter soft key to enter LAN Port :
2. In the LAN Port interface, press the Up or Down key on the phone keyboard to select DHCP (default is DHCP).
3. Press the Enter on the soft key or the OK key on the phone keyboard to enter the DHCP switch interface, it will auto return to last interface after seconds.

### 4.6.2.Static IP Mode

4. In the LAN Port interface, press the Up or Down key on the phone keyboard to select Static IP, then Press the OK key on the phone keyboard or the Enter soft key to enter Static IP Setting interface and input IP address.
5. Press the Down key on the phone keyboard to enter the Subnet Mask of Static IP Setting and input the subnet mask.
6. Input the IP address, Subnet mask, Gateway, DNS 1 and DNS 2 in the corresponding area, press the OK key on the phone keyboard or the Save soft key to save.

### 4.6.3.PPPoE Mode

1. In the LAN Port interface, press the Up or Down key on the phone keyboard to select PPPoE, then press the OK key on the phone keyboard or the Enter soft key to enter PPPoE Setting interface.
2. Press the Up or Down key on the phone keyboard to enter User Name and Password:
3. In according areas input User Name, Password;

## 4.7. WebServer

In the Advanced Setting interface, press the Up or Down key on the phone keyboard to select “WebServer,” press OK key on the phone keyboard or the Enter soft key to access the disable/enable WebServer settings.

## 4.8. Reset to Factory

In the Advanced Setting interface, press the Up or Down key on the phone keyboard to select “Reset to factory”, Press the OK key on the phone keyboard or the Enter soft key to access the reset to factory interface:

## 4.9. Reboot

This is a function to set the phone reboot.

1. In the Advanced Setting interface, press the Up or Down key on the phone keyboard to select Reboot;
2. Press the OK key or the Enter soft key to on the phone keyboard to enter the reboot warning interface.

# 5. WEB Interface

Web user interface (we will used Web UI for short in the following context) which is used for user or administration to check or change the IP SIP phone’s settings.

- Press the OK key on the phone keyboard to check the Phone’s IP address.

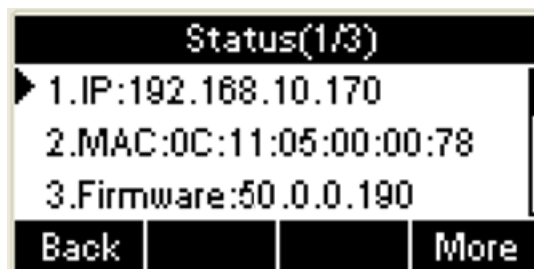

- Type the IP address on IE: <http://192.168.10.170> input default User Name and Password: admin/admin to login the web interface.



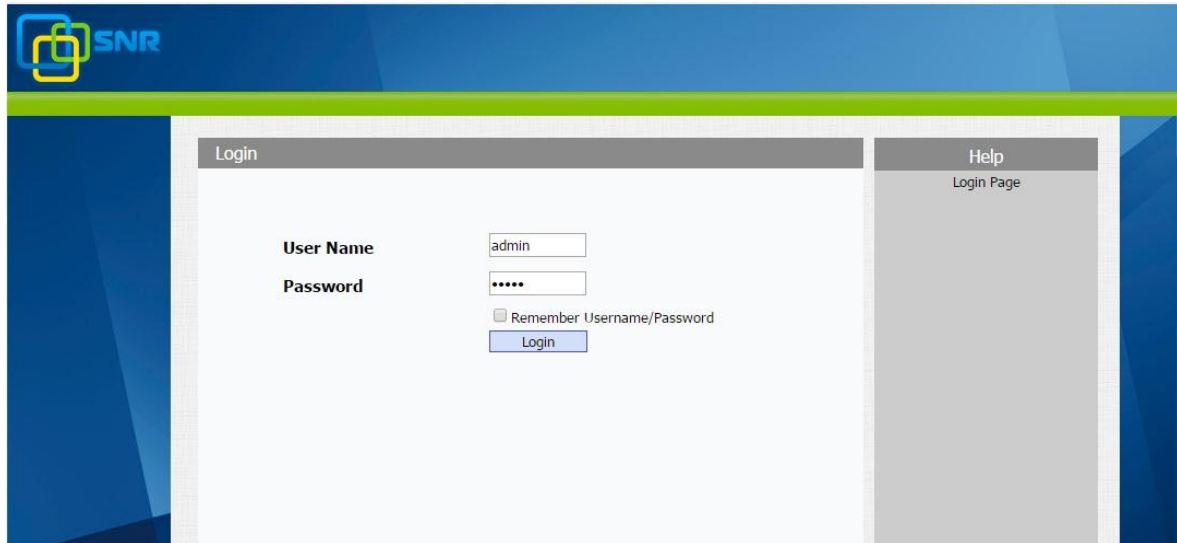

## 5.1. Status->Basic

1. First you need to open a browser (for example IE)
2. Input the IP address in the browser's address bar and then press the Enter key
3. If successfully connected to IP phone, it will prompt a login page. In this page, please input the username and password accordingly. By default, username and password are as below:

User Name: **admin**

Password: **admin**

4. After successfully log in, it will automatically locate to **Status->Basic** Page as shown below:

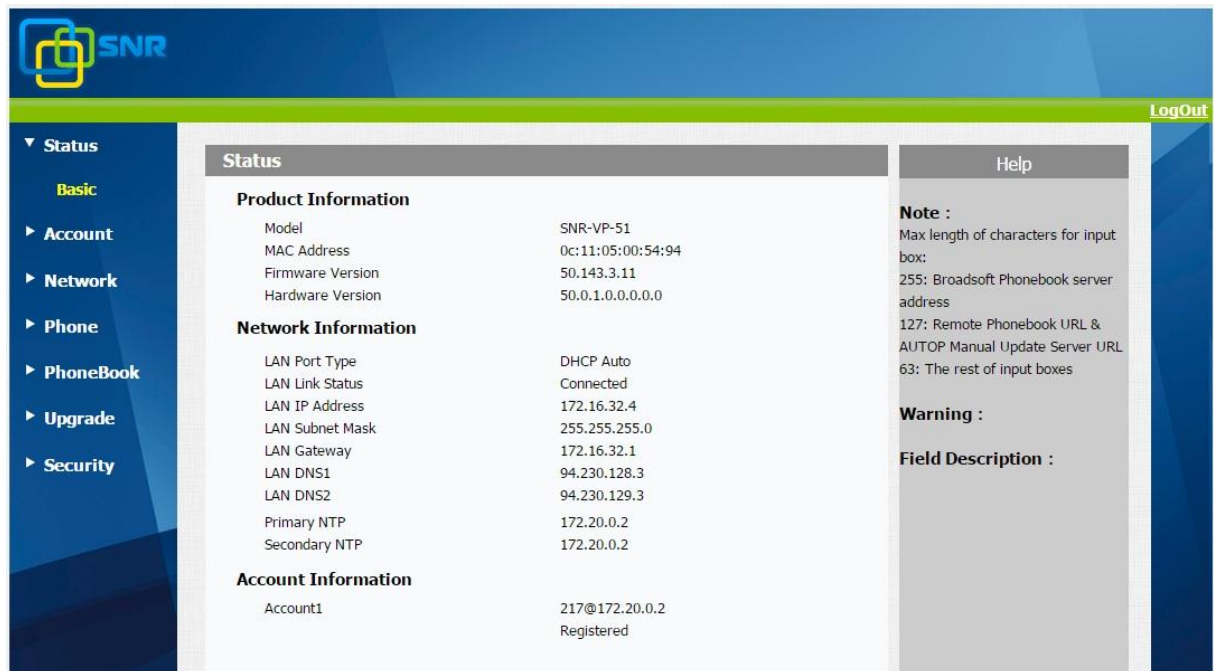

Sections	Description
<b>Product Information</b>	To display the device's information such as Model name, MAC address (IP device's physical address), Firmware version and Hardware firmware.
<b>Network Information</b>	To display the device's Networking status(LAN Port),such as Port Type(which could be DHCP/Static/PPPoE), Link Status, IP Address, Subnet Mask, Gateway, Primary DNS server, Secondary DNS server, and Primary NTP server and Secondary NTP server(NTP server is used to synchronize time from INTERNET automatically).
<b>Account Information</b>	To display device's Account information and Registration status (account username, registered server's address, and Register result).

**Status->Basic** page is used to display some basic information for IP Phone. Please refer to corresponding page for any further information.

## 5.2. Account->Basic

Path: Web UI -> Account->Basic

**Account-Basic**

**SIP Account**

Status: Registered  
 Account Active: Enabled  
 Display Label: test  
 Display Name: 17  
 Register Name: 17  
 User Name: 17  
 Password: .....

**SIP Server 1**

Server IP: 172.20.0.2 Port: 5060  
 Registration Period: 1800 (30~65535s)

**SIP Server 2**

Server IP: Port: 5060  
 Registration Period: 1800 (30~65535s)

**Outbound Proxy Server**

Enable Outbound: Disabled  
 Server IP: Port: 5060  
 Backup Server IP: Port: 5060

**Transport Type**

Transport Type: UDP

**NAT**

NAT: Disabled  
 Stun Server Address: Port: 3478

**Help**

**Note :**  
 Max length of characters for input box:  
 255: Broadsoft Phonebook server address  
 127: Remote Phonebook URL & AUTOP Manual Update Server URL  
 63: The rest of input boxes

**Warning :**

**Field Description :**

**Submit Shortcut**  
 Submit Cancel

Submit Cancel

Sections	Description
<b>SIP Account</b>	To display and configure the specific Account settings. <ul style="list-style-type: none"> <li>● Status: To display register result.</li> <li>● Display Label: Label is displayed on the phone's LCD screen.</li> <li>● Display Name: Name is sent to the other call party for displaying.</li> <li>● Register Name: Allocated by SIP server provider, used for authentication.</li> <li>● User Name: Allocated by your SIP server provide, used for authentication.</li> <li>● Password: Used for authorization.</li> </ul>
<b>SIP Server 1</b>	To display and configure Primary SIP server settings. <ul style="list-style-type: none"> <li>● Server IP: SIP server address, it could be an URL or IP address.</li> </ul>

	<ul style="list-style-type: none"> <li>● Registration Period: The registration will expire after Registration period. The IP phone will re-register automatically within registration period.</li> </ul>
<b>SIP Server 2</b>	<p>To display and configure Secondary SIP server settings. This is for redundancy, if registering to Primary SIP server fails, the IP phone will go to Secondary SIP server for registering.</p> <p><b>Note:</b> Secondary SIP server is used for redundancy; it can be left blank if there is not redundancy SIP server in user's environment.</p>
<b>Outbound Proxy Server</b>	<p>To display and configure Outbound Proxy server settings. An outbound proxy server is used to receive all initiating request messages and route them to the designated SIP server.</p> <p><b>Note:</b> If configured, all SIP request messages from the IP phone will be sent to the outbound proxy server forcefully.</p>
<b>Transport Type</b>	<p>To display and configure Transport type for SIP message</p> <ul style="list-style-type: none"> <li>● UDP: UDP is an unreliable but very efficient transport layer protocol</li> <li>● TCP: Reliable but less-efficient transport layer protocol</li> <li>● TLS: Secured and Reliable transport layer protocol</li> <li>● DNS-SRV: A DNS RR for specifying the location of services.</li> </ul>
<b>NAT</b>	<p>To display and configure NAT (Net Address Translator) settings.</p> <ul style="list-style-type: none"> <li>● STUN: Short for Simple Traversal of UDP over NATS, a solution to solve NAT issues.</li> </ul> <p><b>Note:</b> By default, NAT is disabled.</p>

## 5.3. Account->Advanced

Path: Web UI->Account->Advanced

**Account-Advanced**

**Codecs**

Disabled Codescs	Enabled Codescs
G723_53 G723_63 G726-32	PCMU PCMA G729 G722

**Subscribe**

MWI Subscribe: Disabled

MWI Subscribe Period: 1800 (1800~65535s)

Voice Mail Number:

**DTMF**

Type: RFC2833

How To Notify DTMF: Disabled

DTMF Payload: 101 (96~127)

**Call**

Max Local SIP Port: 5062 (1024~65535)

Min Local SIP Port: 5062 (1024~65535)

Caller ID Header: FROM

Auto Answer: Disabled

Ringtones: Default

Provisional Response ACK: Disabled

User=Phone: Disabled

PTime: 20

Anonymous Call: Disabled

Anonymous Call Rejection: Disabled

Is escape non Ascii character: Enabled

Missed Call Log: Enabled

**Music Server Address**

Active: Disabled

Music Server Address:

**Session Timer**

Active: Disabled

Session Expire: 1800 (90~7200s)

Session Refresher: UAC

**Broadsoft**

AOC: Disabled

**Encryption**

**Help**

**Note :**  
Max length of characters for input box:  
255: Broadsoft Phonebook server address  
127: Remote Phonebook URL & AUTOP Manual Update Server URL  
63: The rest of input boxes

**Warning :**

**Field Description :**

**Submit Shortcut**  
Submit Cancel

Sections	Description
<b>SIP Account</b>	To display current Account settings or to select which account to display.
<b>Codecs</b>	To display and configure available/unavailable codecs list. Codec means coder-decoder which is used to transfer analog signal to digital signal or vice versa. Familiar codecs are G723_53, G723_63, G726_32, PCMA, PCMU, G.729, G722.
<b>Subscribe</b>	To display and configure MWI, subscription settings. <ul style="list-style-type: none"> <li>● MWI: Message Waiting Indicator which is used to indicate whether there is unread new voice messages.</li> </ul>
<b>DTMF</b>	To display and configure DTMF settings. <ul style="list-style-type: none"> <li>● Type: Support Inband, Info, RFC2833 or their combination.</li> <li>● How To Notify DTMF: Only available when DTMF Type is Info.</li> <li>● DTMF Payload: To configure payload type for DTMF.</li> </ul> <p><b>Note:</b> By default, DTMF type is RFC2833 which is the standard. Type Inband uses inband frequency to indicate DTMF tone which is most used to be compatible to traditional telephone server. Type Info use SIP Info message to indicate DTMF message.</p>
<b>Call</b>	To display and configure call-related features. <ul style="list-style-type: none"> <li>● Max Local SIP Port: To configure maximum local sip port for designated account.</li> <li>● Min Local SIP Port: To configure minimum local sip port for designated account.</li> <li>● Caller ID Header: To configure which Caller ID format to fetch for displaying on Phone UI.</li> <li>● Auto Answer: If enabled, IP phone will be auto-answered when there is an incoming call for designated account.</li> <li>● Ringtones: Choose the ringtone for each account.</li> <li>● Provisioning Response ACK: 100% reliability for all provisional message, this means it will send ACK every time the IP phone receive a provisional SIP message from SIP server.</li> <li>● User=phone: If enabled, IP phone will send user=phone within SIP message.</li> <li>● PTime: Interval time between two consecutive RTP packets.</li> <li>● Anonymous Call: If enabled, all outgoing call for the designated account will be anonymous number.</li> <li>● Anonymous Call Rejection: If enabled, all incoming anonymous call for the designated account will be</li> </ul>

	<p>rejected</p> <ul style="list-style-type: none"> <li>● Is escape non Ascii character: To transfer the symbol to Ascii character.</li> <li>● Missed Call Log: To display the miss call log.</li> <li>● Prevent SIP Hacking: Enable or disable to prevent SIP from hacking</li> </ul>
<b>Music Server Address</b>	<p>To display or configure third-party MOH (music-on-hold) server.</p> <ul style="list-style-type: none"> <li>● Active: To enable or disable this MOH server, If enabled, the IP phone will play MOH from configured server.</li> <li>● Music Server Address: To configure MOH server address.</li> </ul>
<b>Session Timer</b>	<p>To display or configure session timer settings.</p> <ul style="list-style-type: none"> <li>● Active: To enable or disable this feature, If enable, the ongoing call will be disconnected automatically once the session expired unless it's been refreshed by UAC or UAS.</li> <li>● Session Expire: Configure session expire time.</li> <li>● Session Refresher: To configure who should be response for refreshing a session.</li> </ul> <p><b>Note:</b> UAC means User Agent Client, here stands for IP phone. UAS means User Agent Server, here stands for SIP server.</p>
<b>Broadsoft</b>	<p>To display or configure Broadsoft AOC feature.</p> <ul style="list-style-type: none"> <li>● AOC:A feature used to be accounting on Broadsoft platform.</li> </ul>
<b>Encryption</b>	<p>To enable or disabled SRTP feature.</p> <ul style="list-style-type: none"> <li>● Voice Encryption (SRTP):If enabled, all audio signal(technically speaking it's RTP streams) will be encrypted for more security.</li> </ul>
<b>NAT</b>	<p>To display NAT-related settings.</p> <ul style="list-style-type: none"> <li>● UDP keepalive message: If enabled, IP phone will send UDP keepalive message periodically to router to keep NAT port alive.</li> <li>● UDP Alive Msg Interval: Keepalive message interval.</li> <li>● Rport: Remote Port, if enabled, it will add Remote Port into outgoing SIP message for designated account.</li> </ul>
<b>Conference</b>	<p>To select Local or network conference</p> <ul style="list-style-type: none"> <li>● Type: To select desired conference type</li> <li>● Conference URI: If network conference is selected, a network conference URI is needed to be input.</li> </ul>
<b>User Agent</b>	<p>One can customize User Agent field in the SIP message; If user agent is set to specific value, user could see the information from SIP message. If user agent is not set by default, user could see the company name, model number and firmware version from SIP message.</p>

## 5.4. Network->Basic

Path: Web UI->Network->Basic

The screenshot shows the 'Network-Advanced' configuration page in the SNR Web UI. The left sidebar lists navigation options: Status, Account, Network (Basic, Advanced), Phone, PhoneBook, Upgrade, and Security. The main content area is divided into several sections:

- Local RTP:** Max RTP Port (12000), Min RTP Port (11800).
- SNMP:** Active (Disabled), Port (empty), Trusted IP (empty).
- VLAN:** LAN Port (Active: Enabled, VID: 100, Priority: 0), PC Port (Active: Disabled, VID: 1, Priority: 0).
- QoS:** SIP QoS (40), Voice QoS (40).
- TR069:** Active (Disabled), Version (1.0), ACS (URL, User Name, Password), Periodic Inform (Active: Disabled, Periodic Interval: 1800), CPE (URL, User Name, Password).

The right sidebar contains a 'Help' section with a 'Note' (Max length of characters for input box: 255; Broadsoft Phonebook server address: 127; Remote Phonebook URL & AUTOP Manual Update Server URL: 63; The rest of input boxes) and a 'Warning' section. Below the warning is a 'Field Description' section and a 'Submit Shortcut' section with 'Submit' and 'Cancel' buttons.

Copyright © 2014 NAG Telecom. All right reserved.

Sections	Description
<b>LAN Port</b>	<p>To display and configure LAN Port settings.</p> <ul style="list-style-type: none"> <li>● DHCP: If selected, IP phone will get IP address, Subnet Mask, Default Gateway and DNS server address from DHCP server automatically.</li> <li>● Static IP: If selected, you have to set IP address, Subnet Mask, Default Gateway and DNS server manually.</li> <li>● PPPoE: Use PPPoE username/password to connect to PPPoE server.</li> </ul>

## 5.5. Network->Advanced

Path: Web UI->Network->Advanced



**Network-Advanced**

**Local RTP**  
 Max RTP Port: 12000 (1024~65535)  
 Min RTP Port: 11800 (1024~65535)

**SNMP**  
 Active: Disabled  
 Port: (0~65535)  
 Trusted IP:

**VLAN**  
 LAN Port: Active: Enabled, VID: 100 (1~4094), Priority: 0  
 PC Port: Active: Disabled, VID: 1 (1~4094), Priority: 0

**QoS**  
 SIP QoS: 40 (0~63)  
 Voice QoS: 40 (0~63)

**TR069**  
 Active: Disabled, Version: 1.0  
 ACS: URL, User Name, Password  
 Periodic Inform: Active: Disabled, Periodic Interval: 1800 (3~3600s)  
 CPE: URL, User Name, Password

Submit Cancel

**Help**  
**Note :**  
 Max length of characters for input box:  
 255: Broadsoft Phonebook server address  
 127: Remote Phonebook URL & AUTOP Manual Update Server URL  
 63: The rest of input boxes  
**Warning :**  
**Field Description :**  
**Submit Shortcut**  
 Submit Cancel

Copyright © 2014 NAG Telecom. All right reserved.

Sections	Description
<b>Local RTP</b>	To display and configure Local RTP settings. <ul style="list-style-type: none"> <li>● Max RTP Port: Determine the maximum port that RTP stream can use.</li> <li>● Min RTP Port: Determine the minimum port that RTP stream can use.</li> </ul>
<b>SNMP</b>	To display and configure SNMP settings. <ul style="list-style-type: none"> <li>● Active: To enable or disable SNMP feature.</li> <li>● Port: To configure SNMP server's port.</li> <li>● Trusted IP: To configure allowed SNMP server address, it could be an IP address or any valid URL domain name.</li> </ul> <p><b>Note:</b> SNMP(Simple Network Management Protocols) is Internet-standard protocol for managing devices on IP networks.</p>
<b>VLAN</b>	To display and configure VLAN settings. <ul style="list-style-type: none"> <li>● LAN Port/PC Port: You can configure VLAN setting for both ports respectively.</li> <li>● Active: To enable or disable VLAN feature for designated port.</li> </ul>

	<ul style="list-style-type: none"> <li>● Vid:To configure VLAN id for designated port.</li> <li>● Priority:To select VLAN priority for designated port.</li> </ul> <p><b>Note:</b> Please consult your administator for specific VLAN settings in your networking environment.</p>
<b>QoS</b>	<p>To display and configure QoS settings.</p> <ul style="list-style-type: none"> <li>● SIP QoS:To configure QoS value for all SIP message.</li> </ul> <p>Voice QoS:To configure QoS value for all audio stream(RTP streams).</p>
<b>TR069</b>	<p>To display and configure TR069 settings.</p> <ul style="list-style-type: none"> <li>● Active: To enable or disable TR069 feature.</li> <li>● Version: To select supported TR069 version (version 1.0 or 1.1).</li> <li>● ACS/CPE: ACS is short for Auto configuration servers as server side, CPE is short for Customer-premise equipment as client side devices.</li> <li>● URL: To configure URL address for ACS or CPE.</li> <li>● User name: To configure username for ACS or CPE.</li> <li>● Password: To configure Password for ACS or CPE.</li> <li>● Periodic Inform: To enable periodically inform.</li> <li>● Periodic Interval: To configure interval for periodic inform.</li> </ul> <p><b>Note:</b> TR-069(Technical Report 069) is a technical specification entitled CPE WAN Management Protocol (CWMP).It defines an application layer protocol for remote management of end-user devices.</p>

## 5.6. Phone ->Time/Lang

Path: Web UI->Phone->Time/Lang

**Time/Lang**

**Web Language**  
Type: English

**LCD Language**  
Type: Русский

**Format Setting**  
Time Format: 24Hour  
Date Format: DD-MM-YYYY  
Display Mode: Day

**Type**  
 Manual  
Date: Year Mon Day  
Time: Hour Min Sec  
 Auto

**NTP**  
Time Zone: +5 Russia(Chelyabinsk)  
Primary Server: 172.20.0.2  
Secondary Server: 172.20.0.2  
Update Interval: 3600 (>= 3600s)

**Daylight Saving Time**  
Active: Disabled  
Offset: 60 (-300~300Minutes)  
 By Date  
Start Time: 1 Mon 1 Day 0 Hour  
End Time: 12 Mon 31 Day 23 Hour  
 By Week  
Start Month: Jan  
Start Week Of Month: First In Month  
Start Day Of Week: Monday  
Start Hour: 0 (0~23)  
End Month: Dec  
End Week Of Month: Fourth In Month  
End Day Of Week: Sunday  
End Hour: 23 (0~23)

**Help**

**Note :**  
Max length of characters for input box:  
255: Broadsoft Phonebook server address  
127: Remote Phonebook URL & AUTOP Manual Update Server URL  
63: The rest of input boxes

**Warning :**

**Field Description :**

**Submit Shortcut**  
Submit Cancel

Submit Cancel

Sections	Description
<b>Web Language</b>	To choose the web language.
<b>LCD Language</b>	To choose the phone language.
<b>Format Setting</b>	To configure time display settings. <ul style="list-style-type: none"> <li>● Time Format: Determine what format to display on Phone UI(12 hour/24 hour).</li> <li>● Date Format: Determine what format to display on Phone UI for Date.</li> <li>● Display Mode: Determine what mode to display Time &amp; Date on Phone UI.</li> </ul>
<b>Type</b>	To select how to configure time, it could be set by manually or get from INTERNET automatically via NTP server. <ul style="list-style-type: none"> <li>● Manual: To set Time and Date manually.</li> <li>● Auto: To get Time via NTP server.</li> </ul> <p><b>Note:</b> If you set time to be Manually, it only take effect till next reboot, after reboot, the phone will switch to Auto mode automatically, because there is no way for IP phone to record time during power off.</p>
<b>NTP</b>	To configure NTP server related settings. <ul style="list-style-type: none"> <li>● Time Zone: To select local Time Zone for NTP server.</li> <li>● Primary Server: To configure primary NTP server address.</li> <li>● Secondary Server: To configure secondary NTP server address, it takes effect if primary NTP server is unreachable.</li> <li>● Update interval: To configure interval between two consecutive NTP requests.</li> </ul> <p><b>Note:</b> NTP, Network Time Protocol is used to automatically synchronize local time with INTERNET time, since NTP server only response GMT time, so that you need to specify the Time Zone for IP phone to decide the local time.</p>
<b>Daylight Saving Time</b>	To display or configure DST settings. <p><b>Note:</b> Here DST, is short for Daylight saving time, which stands for the time in the summer days when sun rises early will be adjusted forward to save daylight. The DST will take effects during the period that set by user. (all the settings for DST are all self-explanatory, please consult with your administrator for local DST details).</p>

## 5.7. Phone->Preference

Path: Web UI->Phone->Preference

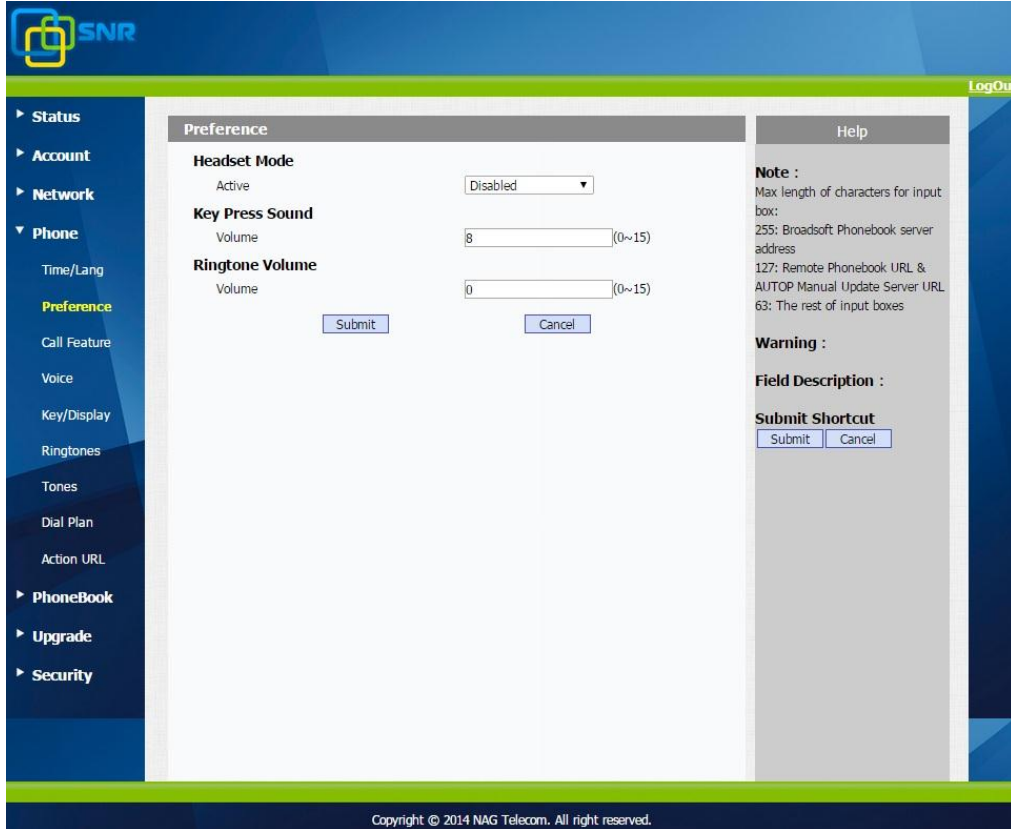

The screenshot displays the 'Preference' configuration page in the SNR web UI. The left sidebar lists various system settings, with 'Preference' highlighted under the 'Phone' category. The main content area is divided into three sections: 'Headset Mode' (Active: Disabled), 'Key Press Sound' (Volume: 8), and 'Ringtone Volume' (Volume: 0). Each section has a 'Submit' and 'Cancel' button. A 'Help' sidebar on the right provides additional information, including a 'Note' on input box lengths, a 'Warning', and a 'Submit Shortcut'.

Sections	Description
<b>Headset Mode</b>	To enable or disable Headset Mode. <ul style="list-style-type: none"> <li>● Active: If enabled, the default audio track will be headset mode, if audio track is changed during a call, it will be back to headset mode after you hang up the call.</li> </ul>
<b>Key Press Sound</b>	To configure the sound volume for key press. <ul style="list-style-type: none"> <li>● Volume: The valid volume range is from 0~15, by default it's 8.</li> </ul>
<b>Ringtone Volume</b>	To configure the sound volume for ringtone. <ul style="list-style-type: none"> <li>● Volume: The valid volume range is from 0~15, by default it's 8.</li> </ul>

## 5.8. Phone->Call Feature

Path: Web UI->Phone->Call Feature

The screenshot shows the 'Call Feature' configuration page in the SNR web UI. The page is divided into several sections, each with its own set of configuration options:

- Mode:** Feature Key Sync (Disabled), Mode (Phone selected, Custom unselected).
- Forward Transfer:** Account (All Account), Always Forward (Disabled), Target Number, On Code, Off Code, Busy Forward (Disabled), Target Number, On Code, Off Code, No Answer Forward (Disabled), No Answer Ring Time (30), Target Number, On Code, Off Code.
- DND:** Account (All Account), DND (Disabled), Return Code When DND (486(Busy Here)), DND On Code, DND Off Code.
- Call Waiting:** Call Waiting Enable (Enabled), Call Waiting Tone (Enabled).
- Auto Redial:** Auto Redial (Disabled), Auto Redial Interval (10, 1~300s), Auto Redial Times (3, 1~100).
- Call Park:** Active (Disabled), Target.
- Intercom:** Active (Enabled), Telephone Mute (Disabled).

The right sidebar contains a 'Help' section with a 'Note' about character limits and a 'Warning' about field descriptions. At the bottom right, there are 'Submit' and 'Cancel' buttons.

Sections	Description
<b>Mode</b>	To enable or disable feature key sync. <ul style="list-style-type: none"> <li>● Feature Key Sync: To enable or disable feature key sync.</li> <li>● Mode: Select the desired mode.</li> </ul>
<b>Forward Transfer</b>	To display and configure Forward setting. <b>Note:</b> There are three types of forward: Always Forward, Busy Forward and No answer Forward. <ul style="list-style-type: none"> <li>● Always Forward: Any incoming call will be forwarded in any situation.</li> </ul>

	<ul style="list-style-type: none"> <li>● Busy Forward: An incoming call will be forwarded if IP phone is busy.</li> <li>● No answer Forward: An incoming call will be forwarded if it's no answer after a specific time.</li> </ul>
<b>Call Waiting</b>	<p>To enable or disable Call Waiting.</p> <ul style="list-style-type: none"> <li>● Call Waiting Enable: If enabled, it allows IP phones to receive a new incoming call when there is already an active call.</li> <li>● Call Waiting Tone: If enabled, it allows IP phones to play the call waiting tone to the waiting callee.</li> </ul>
<b>Auto Redial</b>	<p>Auto redial allows IP phones to redial an unsuccessful call for designated times within designated interval.</p> <ul style="list-style-type: none"> <li>● Auto Redial: To enable or disable auto redial feature.</li> <li>● Auto Redial Interval: Determine the interval between two consecutive attempts.</li> <li>● Auto Redial Times: Determine how many times to redial.</li> </ul>
<b>DND</b>	<ul style="list-style-type: none"> <li>● DND(Do Not Disturb) allows IP phones to ignore any incoming calls.</li> <li>● Return Code when DND: Determine what response code should be sent back to server when there is an incoming call if DND on.</li> <li>● DND On Code: The Code used to turn on DND on server's side, if configured, IP phone will send a SIP message to server to turn on DND on server side if you press DND when DND is off.</li> <li>● DND Off Code: The Code used to turn off DND on server's side, if configured, IP phone will send a SIP message to server to turn off DND on server side if you press DND when DND is on.</li> </ul>
<b>Call Park</b>	<p>Call park allows users to park a call to a special extension and then retrieve it via any other phone within the same system.</p> <ul style="list-style-type: none"> <li>● Active: To enable or disable call park feature.</li> <li>● Account: To determine which account to take effect.</li> <li>● Target: To configure a designated target extension.</li> </ul> <p><b>Note:</b> Please consult with your telephony system administrator for special extension on your system.</p>
<b>Intercom</b>	<p>Intercom allow user to establish a call directly with the callee.</p> <ul style="list-style-type: none"> <li>● Active: To enable or disable Intercom feature.</li> <li>● Intercom Mute: If enabled, once the call established, the callee will be muted.</li> </ul>
<b>Hot Line</b>	<p>Hot Line allow user to call out the defined number automatically without dialing any number.</p> <ul style="list-style-type: none"> <li>● Active: To enable or disable Hot Line feature.</li> <li>● Number: the number you want to dial out automatically.</li> </ul>

	<ul style="list-style-type: none"> <li>● Delay Time: the delay time before calling out.</li> </ul>
<b>Remote Control</b>	<p>Remote Control allows specific host to interact with IP phone by sending HTTP or HTTPS requests. The specific action could be answering an incoming call, hang up an ongoing call and so on.</p> <ul style="list-style-type: none"> <li>● Allowed Access IP List: To configure the allowed host address.</li> </ul> <p><b>Note:</b> For now, IP phone can only support IP address, IP address list and IP address pattern as allowed hosts</p>
<b>Keypad Lock</b>	<p>Keypad Lock allows to lock the keypad of your phone temporarily when you are not using it. This feature helps to protect your phone from unauthorized use.</p> <ul style="list-style-type: none"> <li>● Keypad Lock Type: To lock the phone with function keys or all keys;</li> <li>● Keypad Unlock PIN: To lock the phone with a password.</li> <li>● Keypad Lock Timeout: the idle interval to lock the phone.</li> </ul>
<b>Key As Send</b>	<p>Key As Send allows you to disable send key or assign pound key as send key.</p>
<b>Others</b>	<ul style="list-style-type: none"> <li>● Return Code When Refuse: Allows user to assign specific code as return code to SIP server when an incoming call is rejected.</li> <li>● Auto Answer Delay: To configure delay time before an incoming call is automatically answered.</li> <li>● Early DTMF: To enable or disable early DTMF</li> </ul>



## 5.9. Phone->Voice

Path: Web UI->Phone->Voice

The screenshot shows the SNR Web UI interface for the 'Voice' configuration page. The left sidebar contains navigation options: Status, Account, Network, Phone (with sub-options: Time/Lang, Preference, Call Feature, Voice, Key/Display, Ringtones, Tones, Dial Plan, Action URL), PhoneBook, Upgrade, and Security. The main content area is titled 'Voice' and contains three sections:

- Echo Cancellor:** Echo Cancellor (Enabled), VAD (Disabled), CNG (Enabled).
- Jitter Buffer:** Jitter Type (Fixed), Min Delay (0, 0~1000ms), Nominal Delay (120, 0~1000ms), Max Delay (300, 0~1000ms).
- Mic Volume:** Handset Volume (8, 1~15), Headset Volume (8, 1~15), Hand Free Volume (8, 1~15).

Buttons for 'Submit' and 'Cancel' are located at the bottom of the configuration area. On the right, a 'Help' section contains a 'Note' about input box character limits, a 'Warning' section, and a 'Submit Shortcut' with 'Submit' and 'Cancel' buttons. The footer of the page reads 'Copyright © 2014 NAG Telecom. All right reserved.'

Sections	Description
<b>Echo Cancellor</b>	<p>Echo Cancellor: To remove acoustic echo from a voice Communication in order to improve the voice quality.</p> <ul style="list-style-type: none"> <li>● VAD (Voice Activity Detection): Allow IP phone to detect the presence or absence of human speech during a call. When detecting period of “silence”, VAD replaces that silence efficiently with special packets that indicate silence is occurring. It can facilitate speech processing, and deactivate some processes during non-speech section of an audio session. It can avoid unnecessary coding or transmission of silence packets in VoIP applications, saving on computation and network bandwidth.</li> <li>● CNG (Comfort Noise Generation):allow IP phone to generate comfortable background noise for voice communications during periods of silence in a conversation. It is a part of the silence suppression or VAD handling for VoIP technology. CNG, in conjunction with VAD algorithms, quickly responds when periods of silence occur and inserts artificial noise until voice activity resumes. The insertion of artificial noise gives</li> </ul>

	<p>the illusion of a constant transmission stream, so that background sound is consistent throughout the call and the listener does not think the line has released.</p>
<b>Jitter Buffer</b>	<p>Jitter buffer is a shared data area where voice packets can be collected, stored, and sent to the voice processor in even intervals. Jitter is a term indicating variations in packet arrival time, which can occur because of network congestion, timing drift or route changes. The jitter buffer, located at the receiving end of the voice connection, intentionally delays the arriving packets so that the end user experiences a clear connection with very little sound distortion.</p> <p>IP phones support two types of jitter buffers: fixed and adaptive.</p> <p>Fixed: Add the fixed delay to voice packets. You can configure the delay time for the static jitter buffer on IP phones.</p> <p>Adaptive: Capable of adapting the changes in the network's delay. The range of the delay time for the dynamic jitter buffer added to packets can be also configured on IP phones.</p>
<b>Mic Volume</b>	<p>To configure Microphone volume for headset, handset and speaker mode.</p>

## 5.10.Phone->Key/Display

Path: Web UI->Phone->Key/Display

**Key/Display**

**Soft Key**

Key	Type	Label	Value
Soft Key 1	History		
Soft Key 2	Book		
Soft Key 3	DND		
Soft Key 4	Menu		

**Function Key**

Key	Type	Value
OK	Status	
Cancel	N/A	
Forward	Fwd	
Book	Book	
RD	Redial	
Mute	N/A	

**Others**

Backlight Intensity: 4

Backlight Time: 20

Submit Cancel

**Help**

**Note :**  
Max length of characters for input box:  
255: Broadsoft Phonebook server address  
127: Remote Phonebook URL & AUTOP Manual Update Server URL  
63: The rest of input boxes

**Warning :**

**Field Description :**

**Submit Shortcut**  
Submit Cancel

Copyright © 2014 NAG Telecom. All right reserved.

Sections	Description
<b>Soft Key</b>	Allows user to assign specific feature to the designated soft keys. For softkey, the available features list: DND, Menu, MSG, Status, Book, Fwd, Pickup, Group, Pickup, Intercom, Speed Dial, History, Favorites, Redial, CallReturn, HotDesking.
<b>Function Key</b>	Allows user to assign specific feature to the designated function keys. For function keys, the available features list: N/A, DND, Menu, MSG, Status, Book, Fwd, Pickup, Group Pickup, Intercom, Speed Dial, History, Favorites, Redial, CallReturn, HotDesking, XML Browser.
<b>Others</b>	<ul style="list-style-type: none"> <li>● Backlight Intensity: To adjust the backlight intensity of Phone UI.</li> <li>● Backlight Time: To adjust backlight on timer, once expired the backlight of Phone UI will go off.</li> </ul>

## 5.11.Phone->Ring tones

Path: Web UI->Phone->Ringtones

The screenshot shows the SNR web interface for configuring ringtones. The main content area is titled "Ringtones" and is divided into two sections: "All Ringtones" and "Distinctive Ringers".

**All Ringtones**

Upload(Max Total Size: 100K)

Uploaded Ringtones

System Ringtones

**Distinctive Ringers**

Index	Keyword	Ringtone
0		Ring1.wav
1		Ring1.wav
2		Ring1.wav
3		Ring1.wav
4		Ring1.wav
5		Ring1.wav
6		Ring1.wav
7		Ring1.wav
8		Ring1.wav
9		Ring1.wav
10		Ring1.wav
11		Ring1.wav

**Help**

**Note :**  
 Max length of characters for input box:  
 255: Broadsoft Phonebook server address  
 127: Remote Phonebook URL & AUTOP Manual Update Server URL  
 63: The rest of input boxes

**Warning :**

**Field Description :**

**Submit Shortcut**

Copyright © 2014 NAG Telecom. All right reserved.

Sections	Description
<b>All Ringtones</b>	Allow user to upload and view ringtone files or delete uploaded ringtone files.
<b>Distinctive Ringers</b>	Distinctive ringers allow different incoming calls to trigger distinctive ringtones. The IP phone will check "Alert-Info" header inside the incoming "invite" SIP message. And strip out the URL or keyword inside the "Alert-Info" header, from the specific URL or keyword to match or download designated ringtones to play.

## 5.12.Phone->Tones

Path: Web UI->Phone->Tones

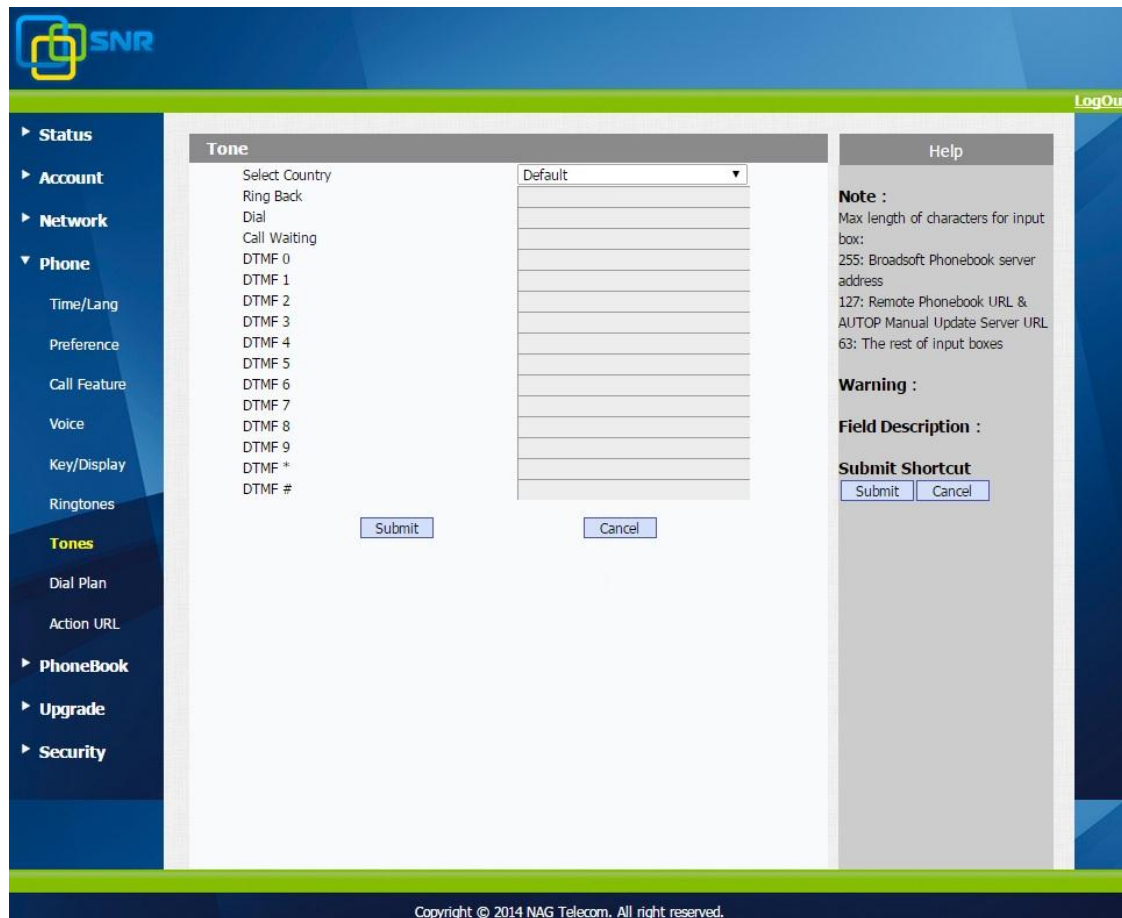

Sections	Description
Tone	<p>Allows user to select a specialized tone sets (classified by countries) or to customize own tones.</p> <p><b>Note:</b> Available country tones sets are: China, Spain, Luxembourg, Sweden, Taiwan, Belgium, Denmark, Finland, Germany, Netherlands, Norway, Portugal.</p>

## 5.13.Phone->Dial Plan->Replace Rule

Path: Web UI->Phone->Dial Plan->Replace Rule

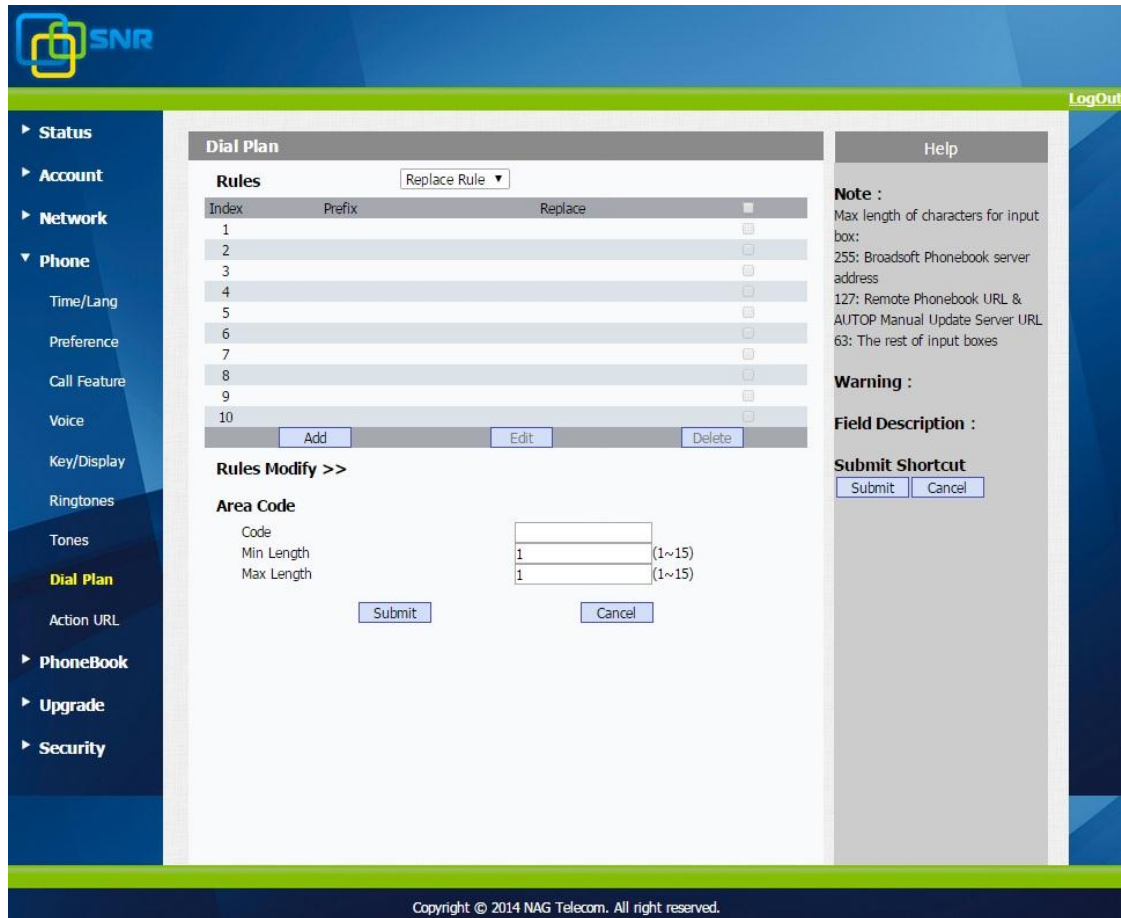

Sections	Description
<b>Rules</b>	Allow user to select Replace rule or Dial-now to display or edit.
<b>Rules Modify</b>	Allow user to modify selected rules information, for replace rule, you can modify related account, prefix and replace.
<b>Area Code</b>	Area codes are also known as NPAs (Numbering Plan Areas). They usually indicate different geographical areas within one country. If entered numbers match the predefined area code rule, the IP phone will automatically prefix outgoing number with area code. <b>Note:</b> There is only one area code rule supported.

## 5.14.Phone ->Dial Plan->Dial Now

**Path:** Web UI->Phone->Dial Plan->Dial Now

Sections	Description
<b>Rules</b>	Allow user to select Replace rule or Dial-now to display or edit.
<b>Dial Now Delay</b>	Allow user configure dial now delay time for dial now. It means user can configure the IP phone to dial out the phone number automatically after the designated delay time if it match any dial now rule.
<b>Rules Modify</b>	Allow user to modify selected rules information, for dial-now rule, user can modify related account, Dial now Rule itself.
<b>Area Code</b>	Area codes are also known as NPAs (Numbering Plan Areas). They usually indicate different geographical areas within one country. If entered numbers match the predefined area code rule, the IP phone will automatically prefix outgoing number with area code. <b>Note:</b> There is only one area code rule supported.

## 5.15.Phone ->Action URL

Path: Web UI->Phone->Action URL

The screenshot shows the SNR web interface for configuring Action URLs. The left sidebar lists various settings categories, with 'Action URL' highlighted. The main panel displays a list of call events on the left and a corresponding list of input boxes on the right. The first input box is set to 'Disabled'. A 'Help' section on the right provides a note about character limits and field descriptions, along with 'Submit' and 'Cancel' buttons.

Sections	Description
<b>Action URL</b>	<p>To display and configure Action URL settings.</p> <p>Setup Completed: When the IP phone completes startup.</p> <ul style="list-style-type: none"> <li>● Registered: When the IP phone successfully registers an account.</li> <li>● Unregistered: When the IP phone logs off the registered account.</li> <li>● Register Failed: When the IP phone fails to register an account.</li> <li>● Off Hook: When the IP phone is off hook.</li> <li>● On Hook: When the IP phone is on hook.</li> <li>● Incoming Call: When the IP phone receives an incoming call.</li> <li>● Outgoing Call: When the IP phone places a call.</li> <li>● Established: When the IP phone establishes a call.</li> <li>● Terminated: When the IP phone terminates a call.</li> <li>● Open DND: When the IP phone enables the DND mode.</li> </ul>



	<ul style="list-style-type: none"> <li>● Close DND: When the IP phone disables the DND mode.</li> <li>● Open Always Forward: When the IP phone enables the always forward.</li> <li>● Close Always Forward: When the IP phone disables the always forward.</li> <li>● Open Busy Forward: When the IP phone enables the busy forward.</li> <li>● Close Busy Forward: When the IP phone disables the busy forward.</li> <li>● Open No Answer Forward: When the IP phone enables the no answer forward.</li> <li>● Close No Answer Forward: When the IP phone disables the no answer forward.</li> <li>● Transfer Call: When the IP phone transfers a call.</li> <li>● Blind Transfer: When the IP phone blind transfers a call.</li> <li>● Attended Transfer: When the IP phone performs the semi-attended/attended transfer.</li> <li>● Hold: When the IP phone places a call on hold.</li> <li>● UnHold: When the IP phone retrieves a hold call.</li> <li>● Mute: When the IP phone mutes a call.</li> <li>● UnMute: When the IP phone un-mutes a call.</li> <li>● Missed Call: When the IP phone misses a call.</li> <li>● IP Changed: When the IP address of the IP phone changes.</li> <li>● FWD Incoming Call: When the IP phone forwards an incoming call.</li> <li>● Reject Incoming Call: When the IP phone rejects an incoming call.</li> <li>● Answer New Call: When the IP phone answers a new call.</li> <li>● Transfer Finished: When the IP phone completes to transfer a call.</li> <li>● Transfer Failed: When the IP phone fails to transfer a call.</li> <li>● Idle To Busy: When the state of the IP phone changes from idle to busy.</li> <li>● Busy To Idle: When the state of phone changes from busy to idle.</li> </ul>
--	---

## 5.16.PhoneBook->Local Phone Book

Path: Web UI->PhoneBook->Local Book

Sections	Description
<b>Contact</b>	To display and select local contact type. <ul style="list-style-type: none"> <li>● All Contacts: To display or edit all local contacts.</li> <li>● Favorites: To display or edit favorites contacts.</li> <li>● Black List: To display black list contacts.</li> </ul>
<b>Search</b>	To search designated contacts from local phonebook.
<b>Dial</b>	To dial out a call or hang up an ongoing call from Web UI. <b>Note:</b> For this feature, you need to have the remote control privilege to control IP phone via Web UI. Please refer to section “Remote Control” in the Web UI->Phone->Call Feature

	page.
<b>Group</b>	To display or edit Group contacts.
<b>Group Setting</b>	To display or change Group name, related ringtone or description.
<b>Import/Export</b>	To import or export the contact or blacklist file.

## 5.17.Phone Book->Remote Phone Book

**Path:** Web UI->PhoneBook->Remote Book

The screenshot shows the SNR Web UI interface. On the left is a navigation sidebar with categories: Status, Account, Network, Phone, PhoneBook (with sub-items: Local Book, Remote Book, Call Log, LDAP, Broadsoft), Upgrade, and Security. The main content area is titled 'Remote Book' and contains a table with columns 'Index', 'Local Book URL', and 'Local Book Name'. The table has 5 rows. Below the table are 'Submit' and 'Cancel' buttons. To the right of the table is a 'Help' section containing a 'Note' about character limits (255 for URL, 127 for Name, 63 for other fields), a 'Warning' section, and a 'Field Description' section with 'Submit Shortcut' buttons.

Sections	Description
<b>Remote Book</b>	<p>To display and configure Remote Book settings.</p> <p>Index: To select desired Remote Book item to display and configure.</p> <p>Local Book URL: To configure remote book server address</p> <p>Local Book Name: To configure display remote book name on Phone UI</p> <p>Search Remote Phonebook Name: To enable or disable search remote phonebook name</p> <p>Search Flash Interval: To set interval (Range from 120s to 2592000s)</p>

## 5.18.Phone Book->Call log

Path: Web UI->PhoneBook ->Call Log

**Call Log**

Call History All Hand Up

Index	Type	Date	Time	Local Identity	Name	Number
1	Received	2014-12-18	10:21:48	17@172.20.0.2	Evgeniu Pankov	<a href="#">167@172.20.0.2</a>
2	Missed	2014-12-18	09:10:35	17@172.20.0.2	Litvinov Alexandr	<a href="#">155@172.20.0.2</a>
3	Received	2014-12-17	17:23:15	17@172.20.0.2	Anastasia Gulyaeva	<a href="#">302@172.20.0.2</a>
4	Missed	2014-12-17	17:15:22	17@172.20.0.2	Leonid Korolev	<a href="#">117@172.20.0.2</a>
5	Received	2014-12-17	17:11:16	17@172.20.0.2	Litvinov Alexandr	<a href="#">155@172.20.0.2</a>
6	Received	2014-12-17	17:09:12	17@172.20.0.2	Litvinov Alexandr	<a href="#">155@172.20.0.2</a>
7	Received	2014-12-17	16:51:46	17@172.20.0.2	Jdanova Galina	<a href="#">145@172.20.0.2</a>
8	Missed	2014-12-17	15:29:15	17@172.20.0.2	Evgeniya K	<a href="#">118@172.20.0.2</a>
9	Received	2014-12-17	15:29:06	17@172.20.0.2	Viktor Tyupa	<a href="#">130@172.20.0.2</a>
10	Received	2014-12-17	14:34:55	17@172.20.0.2	Viktor Tyupa	<a href="#">130@172.20.0.2</a>
11	Received	2014-12-17	14:18:31	17@172.20.0.2	Viktor Tyupa	<a href="#">130@172.20.0.2</a>
12	Received	2014-12-17	14:08:06	17@172.20.0.2	Viktor Tyupa	<a href="#">130@172.20.0.2</a>
13	Received	2014-12-17	13:32:34	17@172.20.0.2	Tenikov Vladimir	<a href="#">148@172.20.0.2</a>
14	Missed	2014-12-17	11:44:07	17@172.20.0.2	Sergey Novikov	<a href="#">206@172.20.0.2</a>
15	Received	2014-12-17	11:24:35	17@172.20.0.2	Tenikov Vladimir	<a href="#">148@172.20.0.2</a>

Page 1 Prev Next Delete Delete All

**Help**

**Note :**  
 Max length of characters for input box:  
 255: Broadsoft Phonebook server address  
 127: Remote Phonebook URL & AUTOP Manual Update Server URL  
 63: The rest of input boxes

**Warning :**

**Field Description :**

Sections	Description
<b>Call History</b>	<p>To display call history records.</p> <p>Available call history type are All calls, Dialed calls, Received calls, Missed calls, Forwarded calls.</p> <p>HangUp: To click to hang up ongoing call on the IP phone.</p> <p><b>Note:</b> For "HangUp" feature, you need to have the remote control privilege to control IP phone via Web UI. Please refer to section "Remote Control" in the Web UI-&gt;Phone-&gt;Call Feature page.</p>

## 5.19.Phone Book->LDAP

Path: Web UI->PhoneBook->LDAP

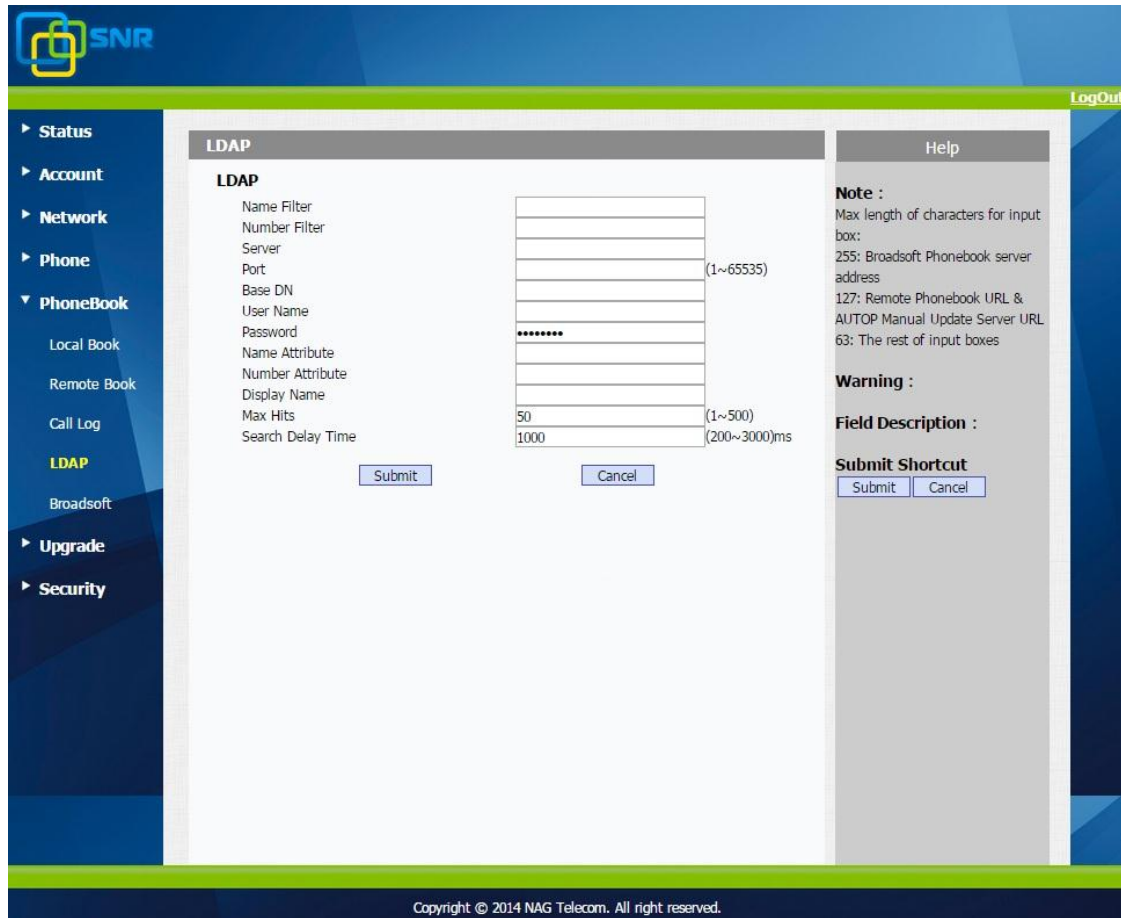

**LDAP**

Name Filter  
 Number Filter  
 Server  
 Port (1~65535)  
 Base DN  
 User Name  
 Password  
 Name Attribute  
 Number Attribute  
 Display Name  
 Max Hits (1~500)  
 Search Delay Time (200~3000)ms

Submit Cancel

**Help**

**Note :**  
 Max length of characters for input box:  
 255: Broadsoft Phonebook server address  
 127: Remote Phonebook URL & AUTOP Manual Update Server URL  
 63: The rest of input boxes

**Warning :**

**Field Description :**

**Submit Shortcut**  
 Submit Cancel

Copyright © 2014 NAG Telecom. All right reserved.

Sections	Description
LDAP	<p>To display and configure LDAP phonebook settings.</p> <ul style="list-style-type: none"> <li>● Name Filter: The settings used to tell LDAP server what name attributes to search.</li> <li>● Number Filter: The settings used to tell LDAP server what number attributes to search.</li> <li>● Server: To configure LDAP server's address.</li> <li>● Port: To configure LDAP server's port.</li> <li>● Base DN: To configure searching base DN on LDAP server.</li> <li>● User Name: To configure user name for accessing LDAP server.</li> <li>● Password: To configure password for accessing LDAP server.</li> <li>● Name Attribute: To configure which name attributes should be feedback from LDAP server.</li> </ul>

	<ul style="list-style-type: none"> <li>● Number Attribute: To configure which number attributes should be feedback from LDAP server.</li> <li>● Display Name: To configure display name on Phone UI when there is any searching result from LDAP server.</li> <li>● Max Hits: To configure the maximum size of result response from LDAP server.</li> <li>● Search Delay Time: To configure delay time before initiate LDAP searching request after you input a value from Phone UI.</li> </ul>
--	---

## 5.20.Phone Book->BroadSoft

Path: Web UI->PhoneBook->Broadsoft

The screenshot displays the 'Broadsoft PhoneBook' configuration interface. The form includes the following fields and controls:

- PhoneBook Item:** A dropdown menu currently showing 'Item1'.
- Display Name:** A text input field.
- Server Address:** A text input field.
- Server Port:** A text input field with a hint '(1~65535)'.
- User Name:** A text input field.
- Password:** A text input field with masked characters (dots).

Below the form are 'Submit' and 'Cancel' buttons. To the right, the 'Help' section provides the following information:

- Note:** Max length of characters for input box: 255; Broadsoft Phonebook server address 127; Remote Phonebook URL & AUTOP Manual Update Server URL 63; The rest of input boxes.
- Warning:** (No specific text is visible).
- Field Description:** (No specific text is visible).
- Submit Shortcut:** Includes 'Submit' and 'Cancel' buttons.

The footer of the page reads: Copyright © 2014 NAG Telecom. All right reserved.

Sections	Description
<b>Broadsoft PhoneBook</b>	<p>To display and configure Broadsoft PhoneBook settings.</p> <ul style="list-style-type: none"> <li>● PhoneBook Item: To select specific item to configure.</li> <li>● Display Name: The name displayed at IP phone's LCD screen when accessed via Phone UI.</li> <li>● Server Address: Broadsoft PhoneBook server's address.</li> <li>● Server Port: Broadsoft PhoneBook server's port.</li> </ul>

	<ul style="list-style-type: none"> <li>● User Name: Username used to access Broadsoft PhoneBook server.</li> <li>● Password: Password used to access Broadsoft PhoneBook server.</li> </ul> <p><b>Note:</b> IP phone supports at most 5 Broadsoft PhoneBook items.</p> <p>For Broadsoft Phone Book's server address, port, username and password, you need to consult your Broadsoft service provider for further information.</p>
--	--

## 5.21.Upgrade->Basic

**Path:** Web UI->Upgrade->Basic

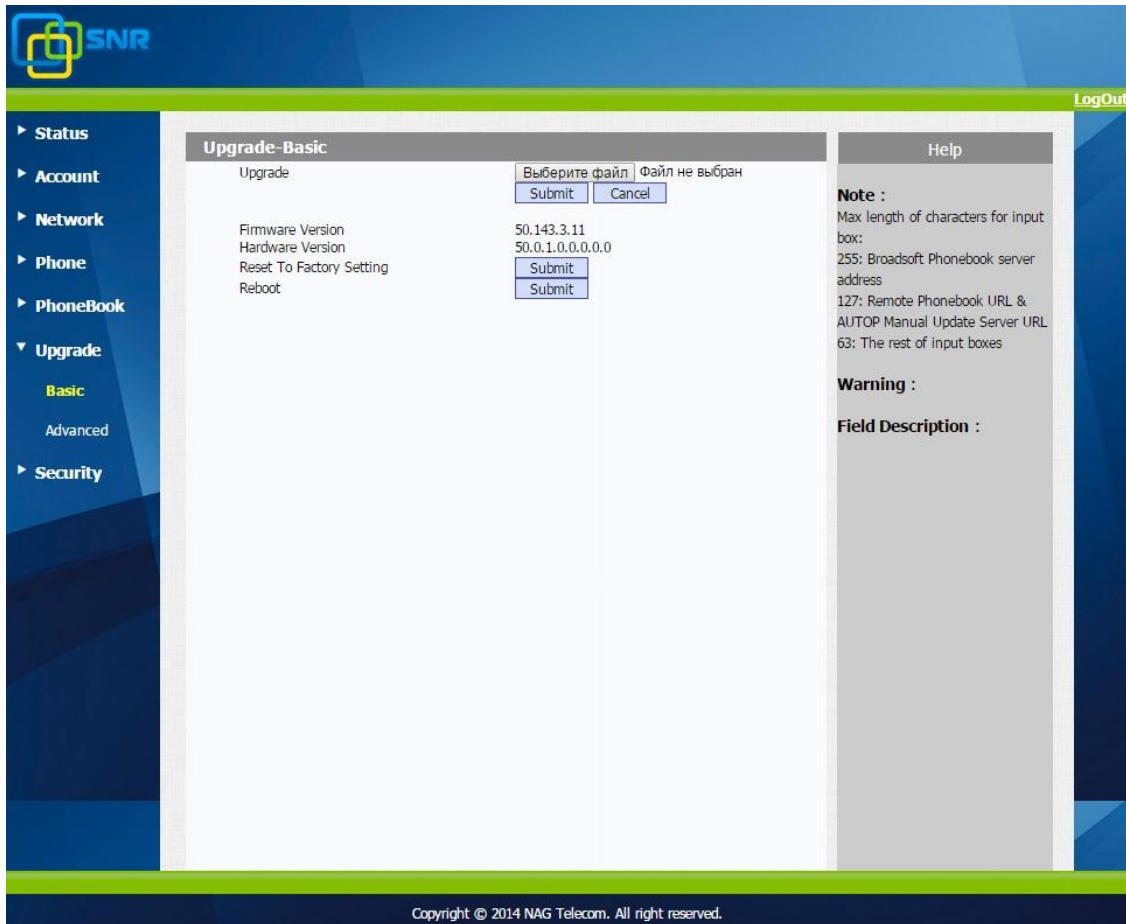

Sections	Description
<b>Upgrade</b>	To select upgrading rom file from local or a remote server automatically. Note: Please make sure it's right file format for right model
<b>Firmware version</b>	To display firmware version, firmware version starts with MODEL name.



	For example, VP50 firmware version should be like 50.xxx.xxx.xxx.
<b>Hardware Version</b>	To display Hardware version.
<b>Reset to Factory Setting</b>	To enable you to reset IP phone's setting to factory settings.
<b>Reboot</b>	To reboot IP phone remotely from Web UI.

## 5.22.Upgrade->Advanced

Path:Web UI->Upgrade->Advanced

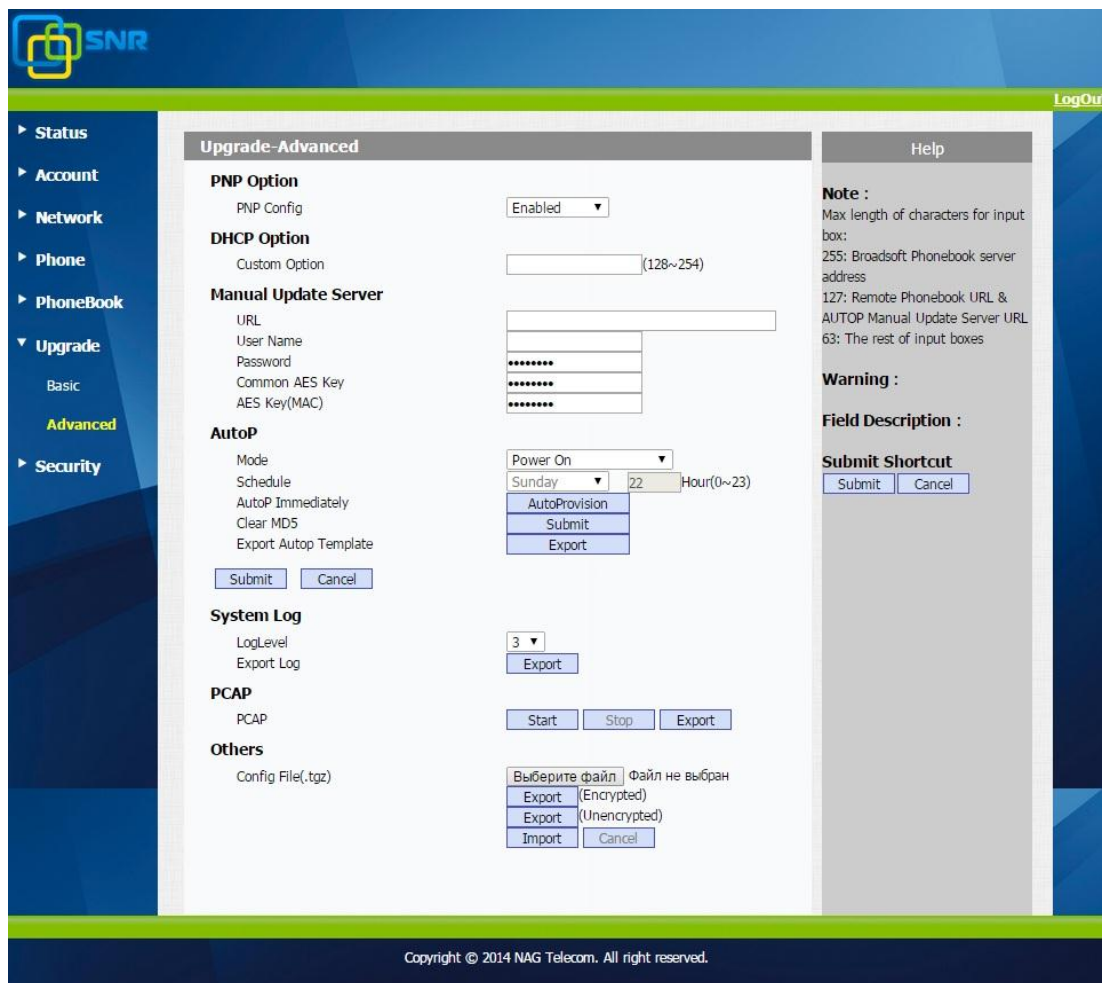

Sections	Description
<b>PNP Option</b>	To display and configure PNP setting for Auto Provisioning. <ul style="list-style-type: none"> <li>● PNP: Plug and Play, Once PNP is enabled, the phone will send SIP subscription message to PNP server automatically to get Auto Provisioning server's address. By default, this SIP message is sent to multicast address 224.0.1.75(PNP server address by standard).</li> </ul>
<b>DHCP Option</b>	To display and configure custom DHCP option.



	<ul style="list-style-type: none"> <li>● DHCP option: If configured, IP Phone will use designated DHCP option to get Auto Provisioning server's address via DHCP.</li> </ul> <p>This setting require DHCP server to support corresponding option.</p>
<b>Manual Update Server</b>	<p>To display and configure manual update server's settings.</p> <ul style="list-style-type: none"> <li>● URL: Auto provisioning server address.</li> <li>● User name: Configure if server needs an username to access, otherwise left blank.</li> <li>● Password: Configure if server needs a password to access, otherwise left blank.</li> <li>● Common AES Key: Used for IP phone to decipher common Auto Provisioning configuration file(for VP-51, this configuration file is 0000000000053.conf).</li> <li>● AES Key(MAC):Used for IP phone to decipher MAC-oriented auto portioning configuration file(for example, file name could be 0c1105888888.conf if IP phone's MAC address is 0c1105888888).</li> </ul> <p><b>Note:</b> AES is one of many encryption, it should be configure only configure filed is ciphered with AES, otherwise left blank.</p>
<b>AutoP</b>	<p>To display and configure Auto Provisioning mode settings.</p> <p>This Auto Provisioning mode is actually self-explanatory.</p> <p>For example, mode "Power on" means IP phone will go to do Provisioning every time it powers on.</p> <p>Remote system log: To enable or disable remote system log.</p> <p>Remote system server: Input remote system server address here if Remote system log is enabled.</p>
<b>System Log</b>	<p>To display syslog level and export syslog file.</p> <ul style="list-style-type: none"> <li>● Syslog level: From level 0~7.The higher level means the more specific syslog is saved to a temporary file. By default, it's level 3.</li> <li>● Export Log: Click to export temporary syslog file to local PC.</li> <li>● Remote System Log: To enable or disable Remote System Log.</li> <li>● Remote System Server: To input the syslog server address.</li> </ul>
<b>PCAP</b>	<p>To start, stop packets capturing or to export captured Packet file.</p> <ul style="list-style-type: none"> <li>● Start: To start capturing all the packets file sent or received from IP phone.</li> <li>● Stop: To stop capturing packets.</li> </ul> <p><b>Note:</b> IP phone will save captured packets file to a temporary file, this file maximum size is 1M (megabytes), and will top</p>

	capturing once reaching this maximum size.
<b>Others</b>	To display or configure others features from this page. Confile file: To export or import configure file for IP phone.

## 5.23.Security->Basic

**Path:** Web UI->Security->Basic

The screenshot shows the SNR Web UI interface. The main content area is titled "Security-Basic" and contains a "Web Password Modify" form. The form has the following fields: "User Name" (with the value "admin"), "Current Password", "New Password", and "Confirm Password". There are "Submit" and "Cancel" buttons below the form. To the right of the form is a "Help" sidebar containing a "Note" section with character limits (255, 127, 63), a "Warning" section, and a "Field Description" section. Below the field description is a "Submit Shortcut" section with "Submit" and "Cancel" buttons. The left sidebar shows a navigation menu with "Security" expanded to "Basic". The footer of the page reads "Copyright © 2014 NAG Telecom. All right reserved."

Sections	Description
<b>Web Password Modify</b>	To modify user's password. <ul style="list-style-type: none"> <li>● Current Password: The current password you used.</li> <li>● New Password: Input new password you intend to use.</li> <li>● Confirm Password: Repeat the new password.</li> </ul> <p><b>Note:</b> For now, IP phone can only support user admin.</p>

## 5.24.Security->Advanced

Path: Web UI->Security->Advanced

The screenshot displays the 'Advanced' configuration page for Security. It features a sidebar with navigation options: Status, Account, Network, Phone, PhoneBook, Upgrade, and Security (Basic, Advanced). The main content area is divided into four sections:

- Web Server Certificate:** A table with columns: Index, Issue To, Issuer, Expire Time, and Delete. Row 1: Index 1, Issue To Ringslink, Issuer Ringslink, Expire Time Sun Jun 27 07:14:32 2037, Delete button.
- Web Server Certificate Upload:** A form with a file selection button (Выберите файл), a status indicator (Файл не выбран), and Submit/Cancel buttons.
- Client Certificate:** A table with columns: Index, Issue To, Issuer, Expire Time, and a delete icon. Rows 1 through 10 are shown.
- Client Certificate Upload:** A form with an Index dropdown (set to Auto), a file selection button (Выберите файл), a status indicator (Файл не выбран), and Submit/Cancel buttons.

The right sidebar contains a 'Help' section with a 'Note' (Max length of characters for input box: 255: Broadsoft Phonebook server address, 127: Remote Phonebook URL & AUTOP Manual Update Server URL, 63: The rest of input boxes) and a 'Warning' section with a 'Field Description'.

Copyright © 2014 NAG Telecom. All right reserved.

Sections	Description
<b>Web Server Certificate</b>	To display or delete Certificate which is used when IP phone is connected from any incoming HTTPs request. <b>Note:</b> The default certificate could not be deleted.
<b>Web Server Certificate Upload</b>	To upload a certificate file which will be used as server certificate.
<b>Client Certificate</b>	To display or delete Certificates which is used when IP phone is connecting to any HTTPs server.
<b>Client Certificate Upload</b>	To upload certificate files, this is used as client certificate. <ul style="list-style-type: none"> <li>● Only Accept trusted Certificates: If this option is enabled, only trusted certificates will be accepted.</li> </ul>

# 6. Troubleshooting

## **Issue 1 : The LCD does not light up**

- Check the AC power adapter. Make sure it is the one provided in your package.
- Check the power outlet. Make sure that the power that outlet you are plugging your device into is working. Try to plug a different device into the socket to make sure it has power.

## **Issue 2 : No signal tone heard from the handset**

- Check the connection cord between the handset and the phone. Make sure it is connected properly.

## **Issue 3 : Cannot access the web interface**

- Check the connection between the PC port of the device and the network port of the computer. Make sure it is fine.
- Check whether the IP address of the device is correct.
- If it is LAN, please make sure there is no IP address collision with other devices on the network.

## **Issue 4 : Cannot call out**

- Please see the network connection status of device, if it is exception, and then check the connection of network.
- If the network connection is normal, please check whether the device has registered successfully.
- If the network connection and the registered are both normal, please confirm whether the dial rule is correct, or please communicate with the service operator.

## 7. Appendix : Time Zones

Time Zone	Time Zone Name
-11:00	Samoa
-10:00	United States-Hawaii-Aleutian
-10:00	United States-Alaska-Aleutian
-09:00	United States-Alaska Time
-08:00	Canada(Vancouver, Whitehorse)
-08:00	Mexico(Tijuana, Mexicali)
-08:00	United States-Pacific Time
-07:00	Canada(Edmonton, Calgary)
-07:00	Mexico(Mazatlan, Chihuahua)
-07:00	United States-Mountain Time
-07:00	United States-MST no DST
-06:00	Canada-Manitoba(Winnipeg)
-06:00	Chile(Easter Islands)
-06:00	Mexico(Mexico City, Acapulco)
-06:00	United States-Central Time
-05:00	Bahamas(Nassau)
-05:00	Canada(Montreal, Ottawa, Quebec)
-05:00	Cuba(Havana)
-05:00	United States-Eastern Time
-04:30	Venezuela(Caracas)
-04:00	Canada(Halifax, Saint John)
-04:00	Chile(Santiago)
-04:00	Paraguay(Asuncion)
-04:00	United Kingdom-Bermuda(Bermuda)
-04:00	United Kingdom(Falkland Islands)
-04:00	Trinidad&Tobago
-04:00	Curacao
-03:30	Canada-New Foundland(St.Johns)

<b>Time Zone</b>	<b>Time Zone Name</b>
-03:00	Denmark-Greenland(Nuuk)
-03:00	Argentina(Buenos Aires)
-03:00	Brazil(no DST)
-03:00	Brazil(DST)
-02:00	Brazil(no DST)
-01:00	Portugal(Azores)
0	GMT
0	Greenland
0	Denmark-Faroe Islands(Torshavn)
0	Ireland(Dublin)
0	Portugal(Lisboa, Porto, Funchal)
0	Spain-Canary Islands(Las Palmas)
0	United Kingdom(London)
0	Morocco
+01:00	Albania(Tirane)
+01:00	Austria(Vienna)
+01:00	Belgium(Brussels)
+01:00	Caicos
+01:00	Chatam
+01:00	Croatia(Zagreb)
+01:00	Czech Republic(Prague)
+01:00	Denmark(Kopenhagen)
+01:00	France(Paris)
+01:00	Germany(Berlin)
+01:00	Hungary(Budapest)
+01:00	Italy(Rome)
+01:00	Luxembourg(Luxembourg)
+01:00	Macedonia(Skopje)
+01:00	Netherlands(Amsterdam)
+01:00	Namibia(Windhoek)
+02:00	Estonia(Tallinn)

<b>Time Zone</b>	<b>Time Zone Name</b>
+02:00	Finland(Helsinki)
+02:00	Gaza Strip(Gaza)
+02:00	Greece(Athens)
+02:00	Israel(Tel Aviv)
+02:00	Jordan(Amman)
+02:00	Latvia(Riga)
+02:00	Lebanon(Beirut)
+02:00	Moldova(Kishinev)
+02:00	Russia(Kaliningrad)
+02:00	Romania(Bucharest)
+02:00	Syria(Damascus)
+02:00	Turkey(Ankara)
+02:00	Ukraine(Kyiv, Odessa)
+03:00	East Africa Time
+03:00	Iraq(Baghdad)
+03:00	Russia(Moscow)
+03:30	Iran(Teheran)
+04:00	Armenia(Yerevan)
+04:00	Azerbaijan(Baku)
+04:00	Georgia(Tbilisi)
+04:00	Kazakhstan(Aktau)
+04:00	Russia(Samara)
+05:00	Kazakhstan(Aqtobe)
+05:00	Kyrgyzstan(Bishkek)
+05:00	Pakistan(Islamabad)
+05:00	Russia(Chelyabinsk)
+05:30	India(Calcutta)
+06:00	Kazakhstan(Astana, Almaty)
+06:00	Russia(Novosibirsk, Omsk)
+07:00	Russia(Krasnoyarsk)
+07:00	Thailand(Bangkok)

<b>Time Zone</b>	<b>Time Zone Name</b>
+08:00	China(Beijing)
+08:00	Singapore(Singapore)
+08:00	Australia(Perth)
+09:00	Korea(Seoul)
+09:00	Japan(Tokyo)
+09:30	Australia(Adelaide)
+09:30	Australia(Darwin)
+10:00	Australia(Sydney, Melbourne, Canberra)
+10:00	Australia(Brisbane)
+10:00	Australia(Hobart)
+10:00	Russia(Vladivostok)
+10:30	Australia(Lord Howe Islands)
+11:00	New Caledonia(Noumea)
+12:00	New Zealand(Wellington, Auckland)
+12:45	New Zealand(Chatham Islands)
+13:00	Tonga(Nukualofa)