

NetAgent

UPS SNMP Agent

User's Manual

User Guide for NetAgent

Version 7.0

Copyright Information

Copyright © 2000-2017, Mega System Technologies, Inc.

All rights reserved.

Reproduction without permission is prohibited.

Technical Support and Contact Information

Mega System Technologies, Inc.

Tel: +886-2-87922060

Fax: +886-2-87922066

Web: www.megatec.com.tw

E-mail: service@megatec.com.tw

Contents

Chapter 1. Introduction	1
1.1 Features	1
1.2 Applications.....	2
Chapter 2. NetAgent Series	4
2.1 NetAgent Mini	4
2.1.1 NetAgent Mini Outlook	5
2.1.2 NetAgent Mini LED Indication	6
2.2 NetAgent II Models	7
2.2.1 NetAgent II Outlook	7
2.2.2 NetAgent II Led Indication.....	10
2.3 NetAgent Mini 9/ NetAgent 9	11
2.3.1 NetAgent Mini 9 Outlook	12
2.3.2 NetAgent Mini 9 LED Indication	14
2.4 NetAgent 9 Series.....	16
2.4.1 NetAgent 9 Outlook	16
2.4.2 NetAgent 9 LED Indication.....	20
2.5 NetAgent Mini 9 / NetAgent 9 Package Accessories	21
Chapter 3. NetAgent Installation	22
3.1 Hardware Installation	22
Internal NetAgent	22
External NetAgent Mini.....	23
External NetAgent II / 9.....	24
3.2 Software Installation	25
Chapter 4. NetAgent Setting	26
4.1 Introduction	26
4.2 NetAgent Login Procedure.....	27
4.3 NetAgent Installation and Setting.....	29
4.4 NetAgent Setting	38
4.4.1 Web Interface.....	38
4.4.2 NetAgent Option Directory Structure	40
4.4.3 NetAgent Setting Options	41
Information > System Status	41
Information > Basic Information.....	43
Information > Current Status	44
Information > Remote Control	45

Information > Meter/Chart	46
Information > SMS Modem Status.....	48
Information > NetSwitch Status.....	49
Information > NetFeeler (NetFeeler II).....	50
Configuration > UPS Configuration	51
Configuration > UPS On/Off Schedule	54
Configuration > Network.....	58
Configuration > Wireless	66
Configuration > SNMP.....	68
Configuration > Email.....	75
Configuration > SMS	80
Configuration > Web/Telnet	83
Configuration > System Time	88
Configuration > SMS Modem.....	90
Configuration > NetSwitch.....	95
Configuration > NetFeeler	100
Configuration > MODBUS	103
Configuration > Language	106
Log Information > Event Log	107
Log Information > SMS Log	108
Log Information > Data Log	109
Log Information > Battery Test Log	111
Help > Search NetAgent	113
Help > Serial Port Debug.....	114
Help > Help	116
Help > About.....	117
Chapter 5. Telnet/ SSH	120
Chapter 6. ClientMate	122
Chapter 7. SNMP View.....	130
Chapter 8. iMConfig.....	138
Chapter 9. SMS Server Software	142
Chapter 10. Appendix.....	148

Chapter 1. Introduction

1.1 Features

NetAgent is the SNMP (Simple Network Management Protocol) card for monitoring UPS. Not only could remote control the UPS and get the current status of it, the NetAgent that has 3 ports or USB ports could also provide other functions, ex. connect to compatible modem to send SMS notification, or our NetFeeler II and its additional sensors for ambient temperature, humidity and water status. This product is for “Contact Closure” and “RS232” interface UPS. The communication protocol includes the Contact Closure, RS232[MegaTec], Phoenixtec], SEC 2400, SEC 9600, Megatec Three Phase, ..etc. NetAgent provides a simple and easy installation procedure. CD provides along with NetAgent offers several software to allow the user to configure IP address; central monitoring and multi shutdown on different operating systems. Other advance configurations could be accomplished in the Web browser.

Features:

- ❶ Provide SNMP MIB to monitor & control UPS
- ❷ Auto-sense 10M /100M Fast Ethernet (*10M/100M/1000M is available for specific model*)
- ❸ Manage and configure via Telnet, Web Browser or NMS
- ❹ Support TCP/IP, UDP, SNMP, Telnet, SNTP, PPP, HTTP, HTTPS, SMTP, Modbus Protocol
- ❺ Support SSL/TLS, SSH Encryption
- ❻ Providing easy setup and upgrade tools via our Netility software
- ❼ Send SNMP TRAP ; E-mail and SMS for events notification.
- ❽ Auto email daily UPS history report
- ❾ Perform graceful shutdown with our ClientMate software
- ❿ Add-on optional NetFeeler II for temperature, humidity, water, smoke and door sensor

1.2 Applications

■ NetAgent allows UPS to be monitor on network

When the UPS connects with NetAgent, the system manager could check each and every UPS condition by a computer with Browser installed. The manager could monitor and control the UPS by simply input the IP address of the NetAgent which connects to the UPS. When there is a power abnormal condition happens, the NetAgent could also send the trap information to the system manager to take proper action.

■ NetAgent Provides Shutdown Utilities

When a computer install our shutdown software in the network that connects to the NetAgent, when UPS is in AC failure condition or Battery Low condition, the software would close all the files of the operating system and shutdown gracefully. This could avoid system corrupt when a power disconnection happened.

■ NetAgent II for Surrounding Monitoring

3 Ports NetAgent or NetAgent with USB ports could connect to optional sensor-NetFeeler II to get the surrounding temperature/humidity/smoke/fire signals. These information could also be revealed on the NetAgent Web page. When there is an abnormal condition happened, it could also be sent as a trap to the system manager.

When we need the NetAgent?

- ❶ When we need to remote monitoring and controls the UPS conditions. For example, the system manager could use the Internet to control all the UPS conditions all over the country. When the shutdown utility is installed, the shutdown utility could close all the files and shutdown the system when a power abnormal condition happened.
- ❷ When we need to monitor surrounding conditions of the server room, warehouse, office, etc. For example, the system manager could know the temperature, humidity, smoke and water condition by our NetFeeler II which connects with NetAgent. User may read the data via NetAgent webpage.

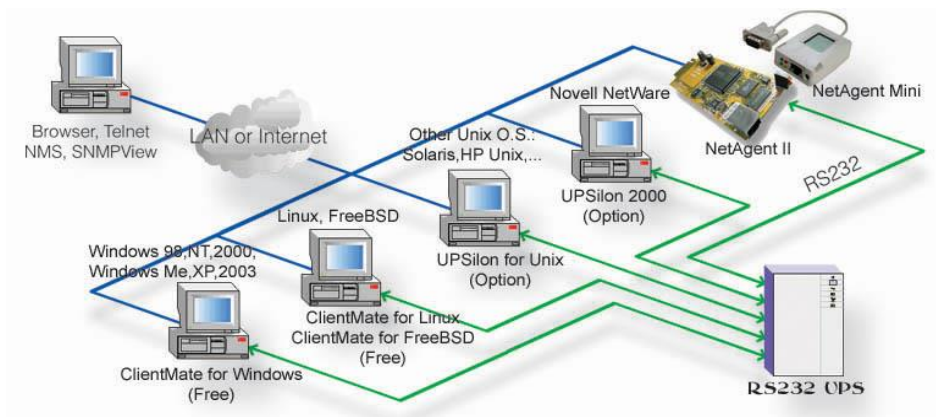

Fig.1 Network connection diagram of NetAgent and shutdown software

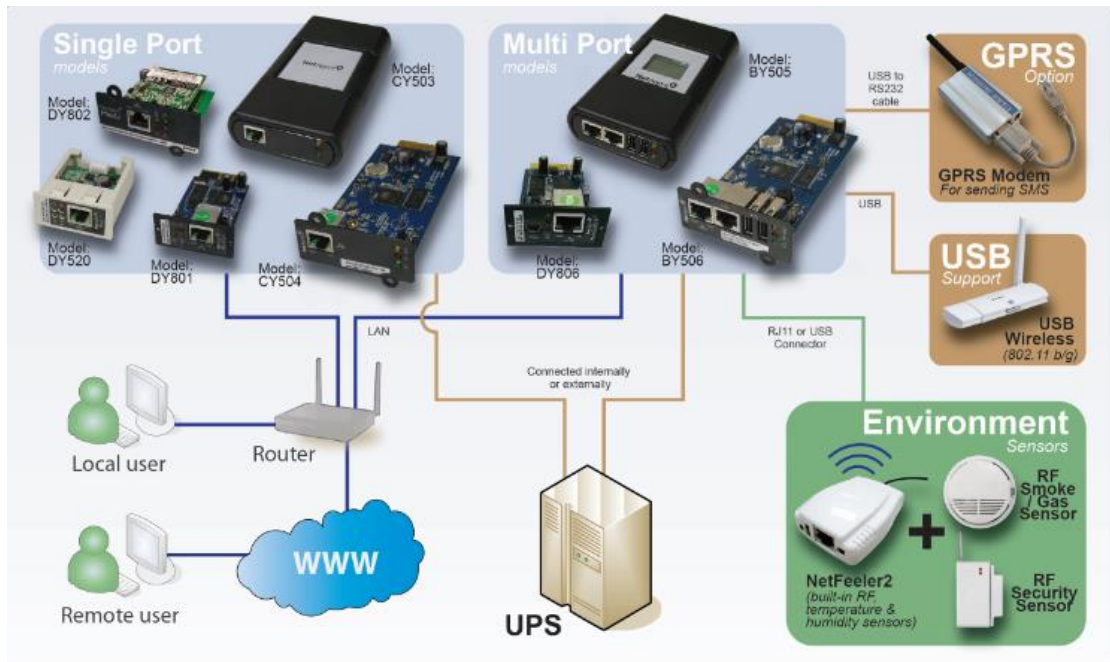









Fig.2 NetAgent 9 connection diagram with NetFeeler

Chapter 2. NetAgent Series

2.1 NetAgent Mini

NetAgent Mini Model									
Model Name	Package Contents	Internal	External	RJ45 Port	RS232 Port	ENV Port	USB Port	Single Phase	Three Phase
DP520 DT520	1. NetAgent Mini SNMP Card 2. NetAgent Utility CD 3. Quick Installation Guide (Optional)	V		V				V	V
DP801 DT801	1. NetAgent Mini SNMP Card 2. NetAgent Utility CD 3. Quick Installation Guide (Optional)	V		V				V	V
DP802 DT802	1. NetAgent Mini SNMP Card 2. NetAgent Utility CD 3. Quick Installation Guide (Optional)	V		V				V	V
DP522 DT522	1. NetAgent Mini SNMP Card 2. NetAgent Utility CD 3. Quick Installation Guide (Optional) 4. Adaptor		V	V				V	V
DP523 DT523 (Dry Contact Only)	1. NetAgent Mini SNMP Card 2. NetAgent Utility CD 3. Quick Installation Guide (Optional) 4. Adaptor		V	V				V	V
DP532 DT532	1. NetAgent Mini SNMP Card 2. NetAgent Utility CD 3. Quick Installation Guide (Optional) 4. Adaptor		V	V				V	V
DP630	1. USB NetAgent Mini SNMP Card 2. NetAgent Utility CD 3. Quick Installation Guide (Optional) 4. Adaptor		V	V				V	V



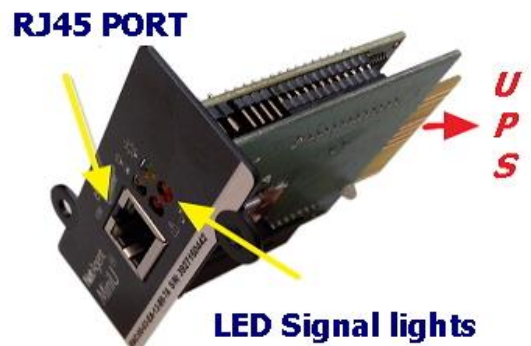
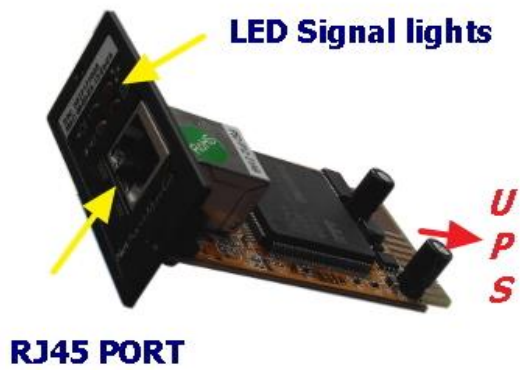

2.1.1 NetAgent Mini Outlook

DP/DT520	DP/DT522	DP/DT523	DP/DT532
			
DP/DT801	DP/DT802	DP630	
			

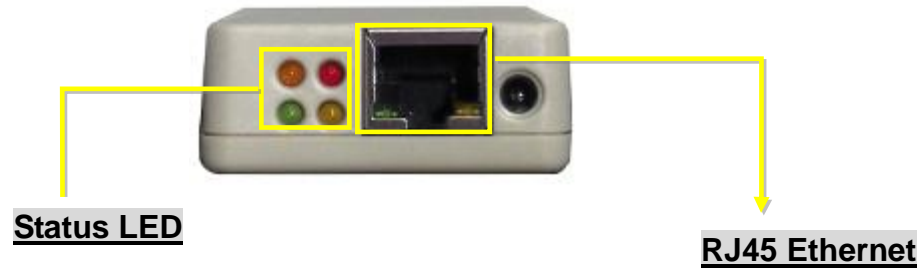

2.1.2 NetAgent Mini LED Indication



Amber  Communication Flashing Transferring data with UPS		Red  Connection Status with UPS <table border="1"> <tr> <td>Flashing</td> <td>Off</td> </tr> <tr> <td>Lost connection</td> <td>Connecting with UPS</td> </tr> </table>		Flashing	Off	Lost connection	Connecting with UPS				
Flashing	Off										
Lost connection	Connecting with UPS										
Green  Power Status <table border="1"> <tr> <td>On</td> <td>Off</td> </tr> <tr> <td>Normal</td> <td>No Power</td> </tr> </table>		On	Off	Normal	No Power	Yellow  NetAgent Mini Status <table border="1"> <tr> <td>On</td> <td>Off</td> </tr> <tr> <td>Operating</td> <td>Stop working</td> </tr> </table>		On	Off	Operating	Stop working
On	Off										
Normal	No Power										
On	Off										
Operating	Stop working										

Green <table border="1"> <tr> <td>On</td> <td>Flashing</td> </tr> <tr> <td>100 Mbps</td> <td>Sending/Receiving Data</td> </tr> </table>		On	Flashing	100 Mbps	Sending/Receiving Data	Yellow <table border="1"> <tr> <td>On</td> <td>Flashing</td> </tr> <tr> <td>10 Mbps</td> <td>Sending/Receiving Data</td> </tr> </table>		On	Flashing	10 Mbps	Sending/Receiving Data
On	Flashing										
100 Mbps	Sending/Receiving Data										
On	Flashing										
10 Mbps	Sending/Receiving Data										





NOTE : When writing firmware, red and yellow led alternating flashing, DO NOT remove any power

2.2 NetAgent II Models

NetAgent II Model									
Model Name	Package Content	Internal	External	RJ45	RS232	ENV	USB	Single Phase	Three Phase
CP503 CT503	1. NetAgent SNMP Card 2. NetAgent Utility CD 3. Quick Installation Guide (Optional) 4. M2501 Cable(For Dry Contact UPS) 5. M2502 or M2505 Cable(For RS232 UPS) 6. Adaptor		V	V				V	V
CP504 CT504	1. NetAgent SNMP Card 2. NetAgent Utility CD 3. Quick Installation Guide (Optional)	V		V				V	V
BT505	1. NetAgent SNMP Card 2. NetAgent Utility CD 3. Quick Installation Guide (Optional) 4. M2501 Cable(For Dry Contact UPS) 5. M2502 or M2505 Cable(For RS232 UPS) 6. M2506 Cable (For Modem) 7. Adaptor		V	V	V	V		V	V
BT506	1. NetAgent SNMP Card 2. NetAgent utility CD 3. Quick Installation Guide (Optional) 4. M2506 Cable (For Modem) 5. Adaptor	V		V	V	V		V	V

NOTE : Model CP/CT are discontinued.

2.2.1 NetAgent II Outlook

CP/CT 503	CP/CT 504
	
BT505	BT506
	

◆ One Port NetAgent II

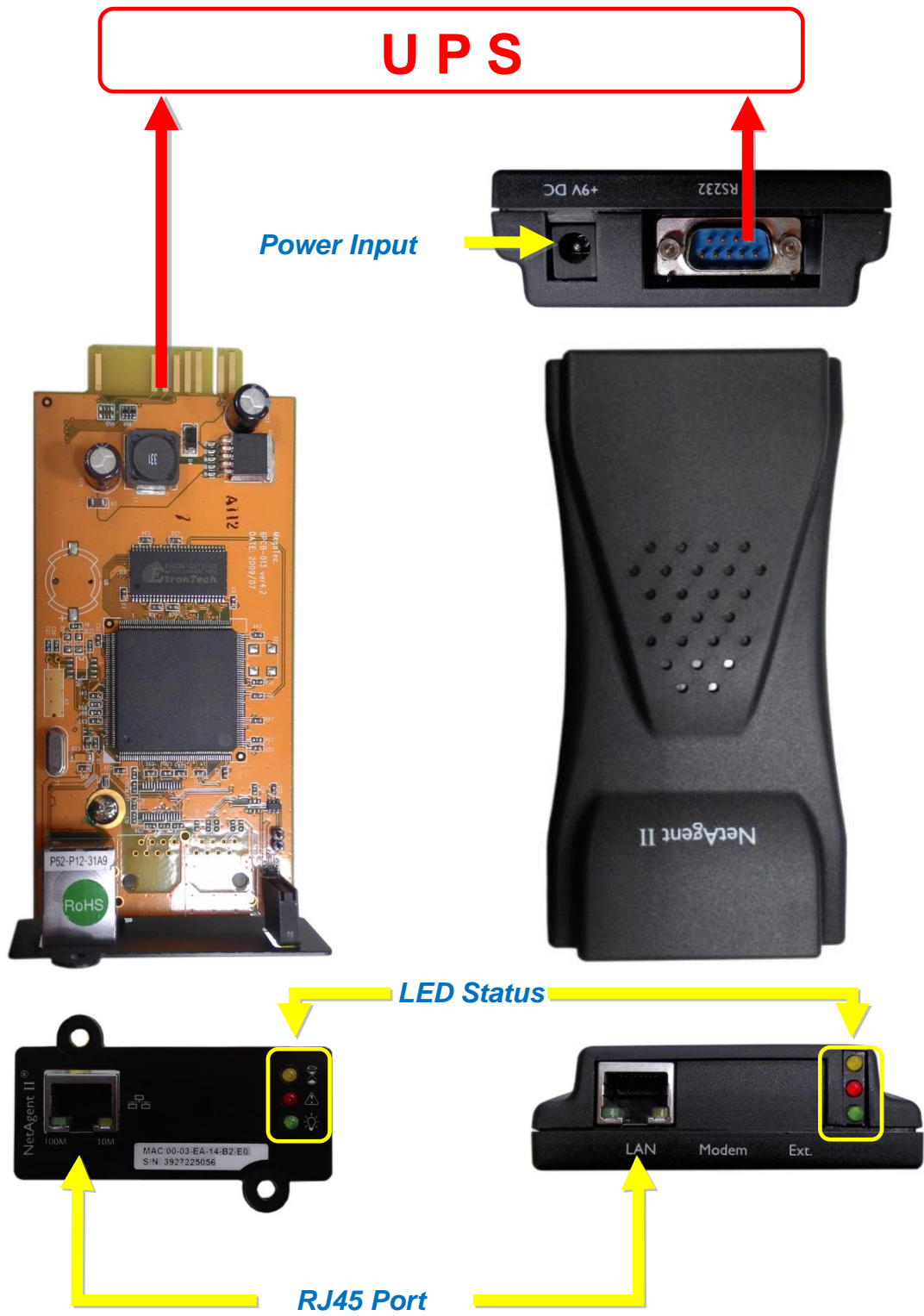

◆ Three Ports NetAgent II

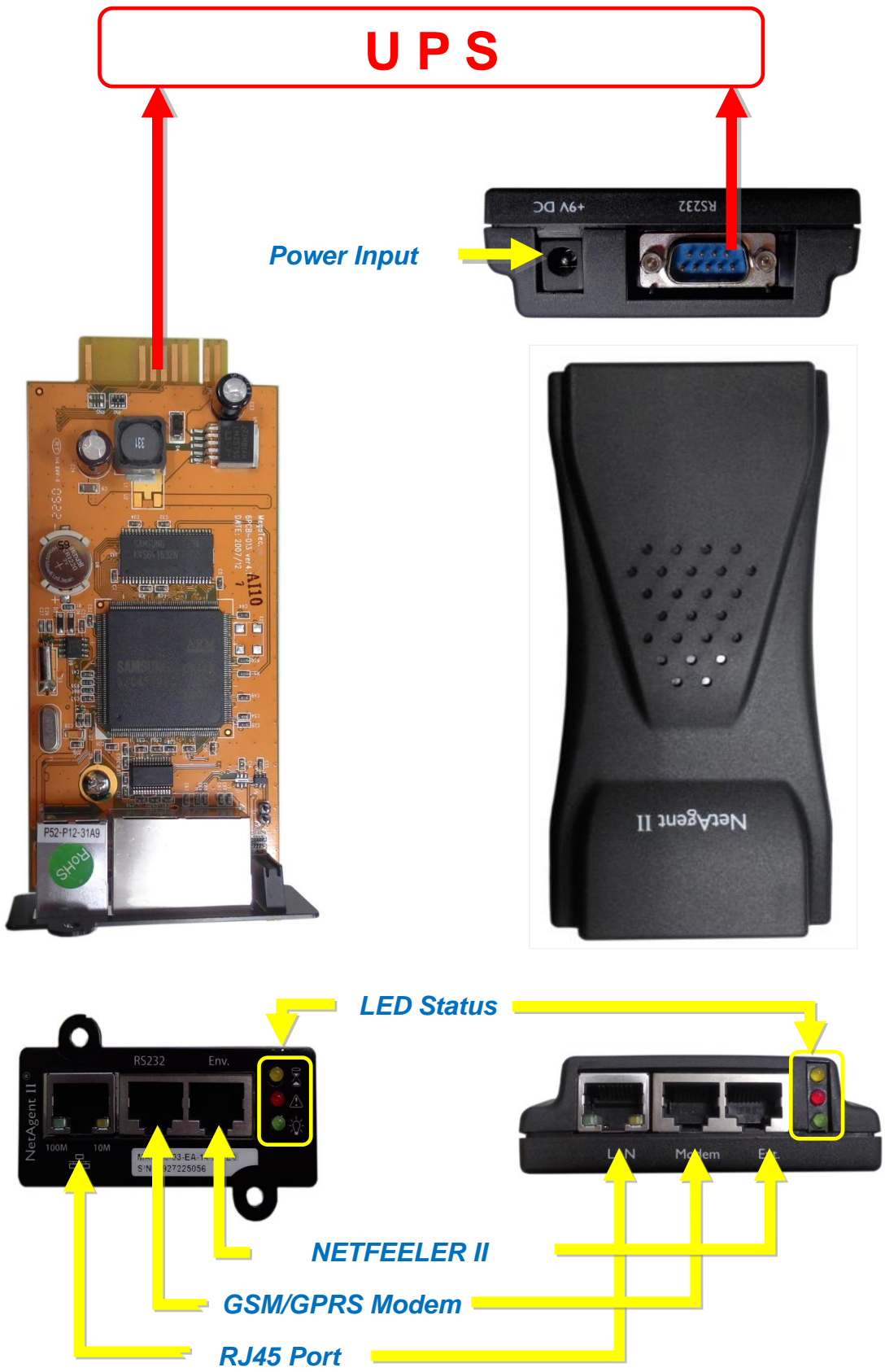

2.2.2 NetAgent II Led Indication

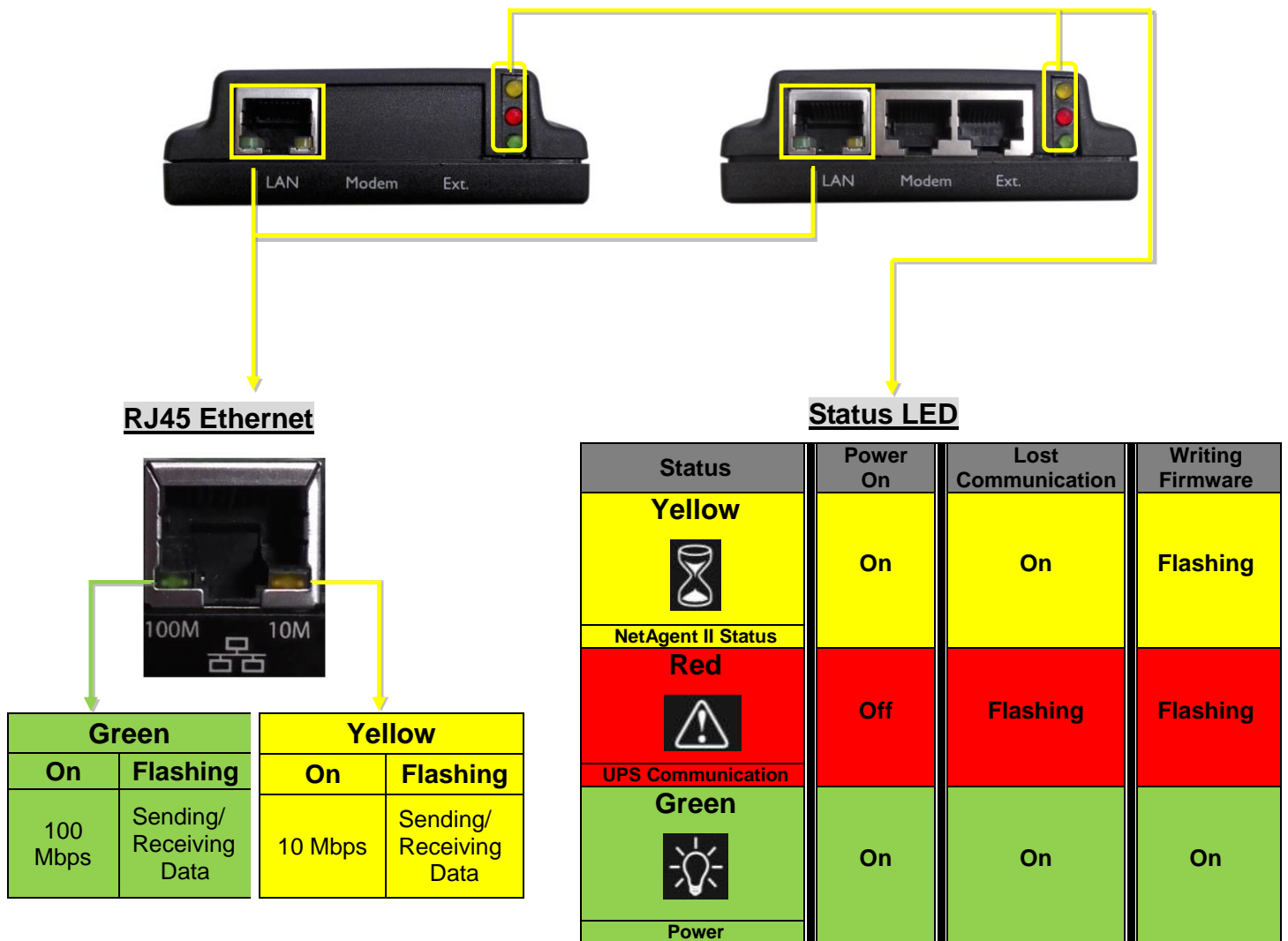

NOTE : When writing firmware, red and yellow led alternating flashing, DO NOT remove any power



2.3 NetAgent Mini 9/ NetAgent 9

NetAgent Mini 9 Models

NetAgent Mini 9 Model									
Model Name	Package Contents	Internal	External	RJ45	RS232	ENV	USB	Single Phase	Three Phase
DX520 DY520	1. NetAgent Mini 9 SNMP Card 2. NetAgent Utility CD 3. Quick Installation Guide (Optional)	V		V				V	V
DX801 DY801	1. NetAgent Mini 9 SNMP Card 2. NetAgent Utility CD 3. Quick Installation Guide (Optional)	V		V				V	V
DX802 DY802	1. NetAgent Mini 9 SNMP Card 2. NetAgent Utility CD 3. Quick Installation Guide (Optional)	V		V				V	V
DX806 DY806	1. NetAgent Mini 9 SNMP Card 2. NetAgent Utility CD 3. Quick Installation Guide (Optional) 4. M2509 Cable (USB)	V		V			V	V	V
DY807	1. NetAgent Mini 9 SNMP Card 2. NetAgent Utility CD 3. Quick Installation Guide (Optional)	V		V			V	V	V
DX522 DY522	1. NetAgent Mini 9 SNMP Card 2. NetAgent Utility CD 3. Quick Installation Guide (Optional) 4. Adaptor		V	V				V	V
DX523 DY523 (Dry Contact Only)	1. NetAgent Mini 9 SNMP Card 2. NetAgent Utility CD 3. Quick Installation Guide (Optional) 4. Adaptor		V	V				V	V
DX532 DY532	1. NetAgent Mini 9 SNMP Card 2. NetAgent Utility CD 3. Quick Installation Guide (Optional) 4. Adaptor		V	V				V	V
DX630 DY630	1. USB NetAgent Mini 9 SNMP Card 2. NetAgent Utility CD 3. Quick Installation Guide (Optional) 4. Adaptor		V	V				V	V

2.3.1 NetAgent Mini 9 Outlook

NetAgent Mini 9 Series			
DX/DY 520	DX/DY 522	DX/DY 523	DX/DY 532
			
DX/DY 801	DX/DY 802	DX/DY 806	DY 807
			
DX/DY 630			
			

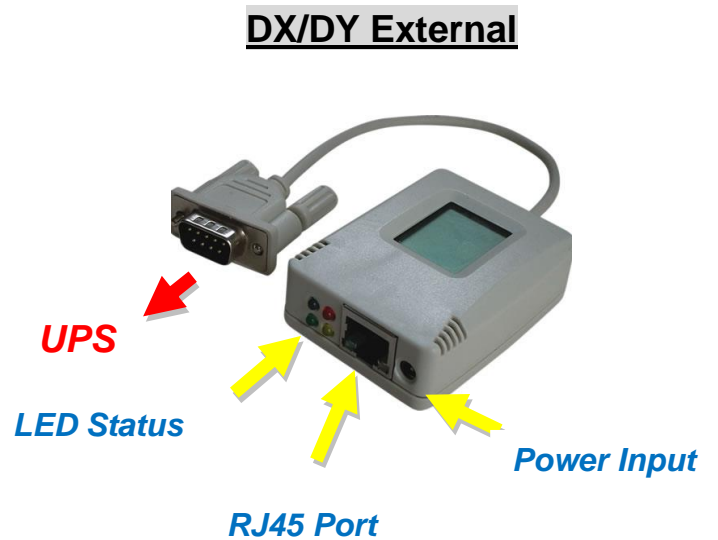
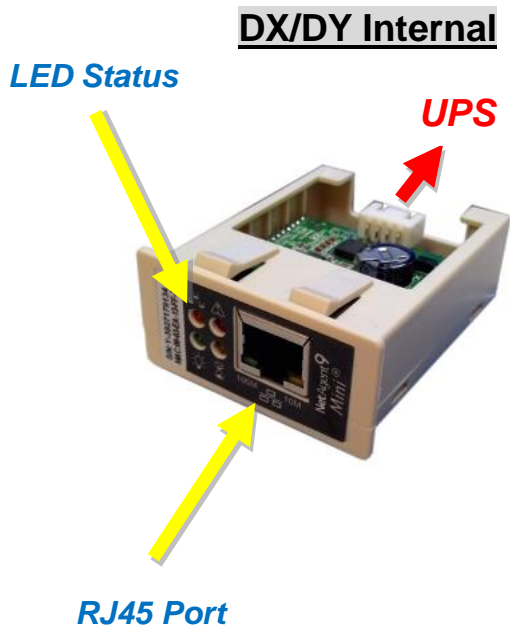

DX/DY 801

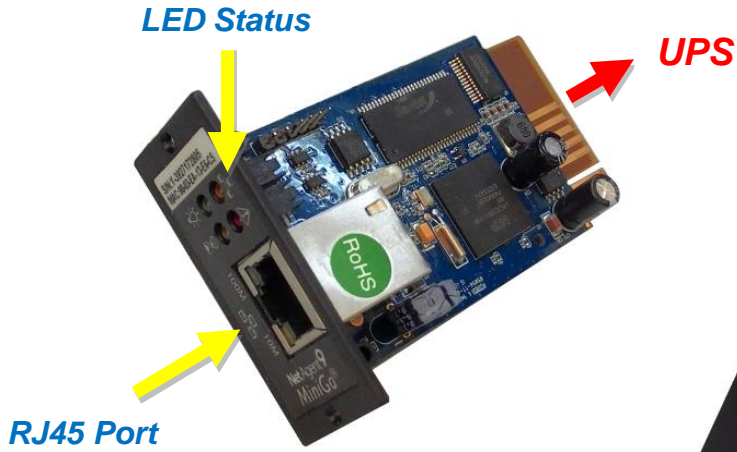

DX/DY 802

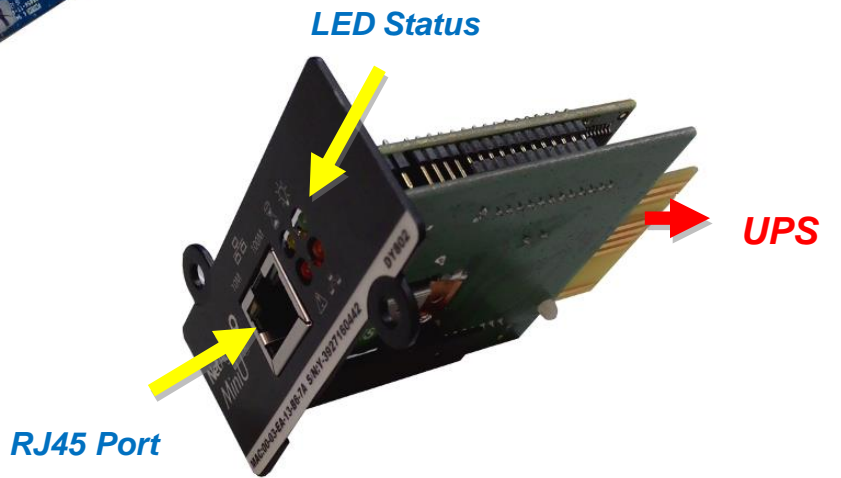

DX/DY 806

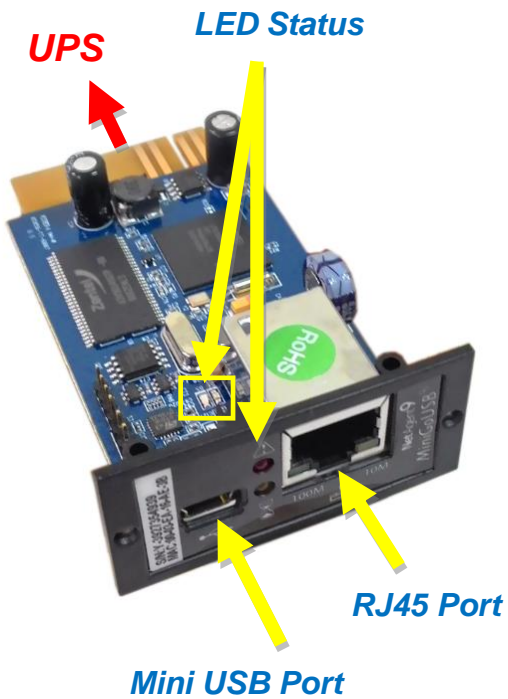



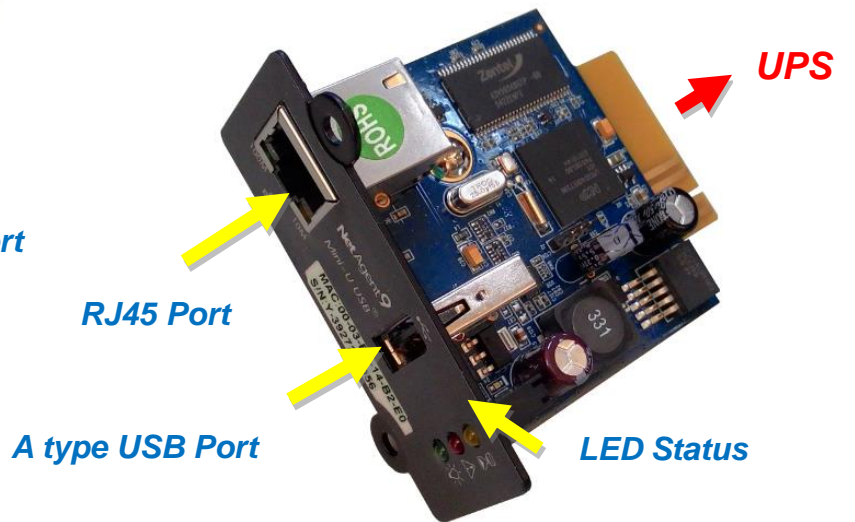

DY 807



2.3.2 NetAgent Mini 9 LED Indication



Amber  Communication Flashing Transferring data with UPS		Red  Connection Status with UPS <table border="1"> <tr> <th>Flashing</th> <th>Off</th> </tr> <tr> <td>Lost connection</td> <td>Connecting with UPS</td> </tr> </table>		Flashing	Off	Lost connection	Connecting with UPS				
Flashing	Off										
Lost connection	Connecting with UPS										
Green  Power Status <table border="1"> <tr> <th>On</th> <th>Off</th> </tr> <tr> <td>Normal</td> <td>No Power</td> </tr> </table>		On	Off	Normal	No Power	Yellow  NetAgent Mini Status <table border="1"> <tr> <th>On</th> <th>Off</th> </tr> <tr> <td>Operating</td> <td>Stop working</td> </tr> </table>		On	Off	Operating	Stop working
On	Off										
Normal	No Power										
On	Off										
Operating	Stop working										

Green <table border="1"> <tr> <th>On</th> <th>Flashing</th> </tr> <tr> <td>100 Mbps</td> <td>Sending/Receiving Data</td> </tr> </table>		On	Flashing	100 Mbps	Sending/Receiving Data	Yellow <table border="1"> <tr> <th>On</th> <th>Flashing</th> </tr> <tr> <td>10 Mbps</td> <td>Sending/Receiving Data</td> </tr> </table>		On	Flashing	10 Mbps	Sending/Receiving Data
On	Flashing										
100 Mbps	Sending/Receiving Data										
On	Flashing										
10 Mbps	Sending/Receiving Data										

NOTE : When writing firmware, red led alternating flashing, DO NOT remove any power





DX/DY 520 Internal





DX/DY 801



DX/DY 802



D5		D4	
Green		Blue	
			
Power		Communication	
On	Off	Flashing	
Normal	No Power	Sending/Receiving Data	

Red	
	
UPS connection	
Flashing	Off
Lost connection	Connecting with UPS
Yellow	
	
NetAgent Mini 9 Status	
On	Off
Operating	Stop Working



D4	
Blue	
	
Communication Status	
Flashing	
Sending/Receiving Data	



Status	Power On	Lost Communication	Writing Firmware
Yellow 	On	On	Off
NetAgent Mini 9 Status			
Red 	Off	Flashing	Flashing
UPS Communication			
Green 	On	On	On
Power			

2.4 NetAgent 9 Series

NetAgent 9 Model									
Model Name	Package Contents	Internal	External	RJ45	RS232	ENV	USB	Single Phase	Three Phase
CX/CY 503	1. NetAgent 9 SNMP Card 2. NetAgent Utility CD 3. Quick Installation Guide (Optional) 4. M2501 Cable(For Dry Contact UPS) 5. M2502or M2505 Cable(For RS232 UPS) 6. Adaptor		V	V				V	V
CX/CY 504	1. NetAgent 9 SNMP Card 2. NetAgent Utility CD 3. Quick Installation Guide (Optional)	V		V				V	V
BX/BY 505	1. NetAgent 9 SNMP Card 2. NetAgent Utility CD 3. Quick Installation Guide (Optional) 4. M2501 Cable(For Dry Contact UPS) 5. M2502 or M2505 Cable(For RS232 UPS) 6. M2506 Cable (For ModBus on RS485) 7. RS485 Converter board 8. Adaptor		V	V		V	V	V	V
BX/BY 506	1. NetAgent 9 SNMP Card 2. NetAgent Utility CD 3. Quick Installation Guide (Optional) 4. M2506 Cable (For ModBus on RS485) 5. RS485 Converter board	V		V		V	V	V	V

2.4.1 NetAgent 9 Outlook

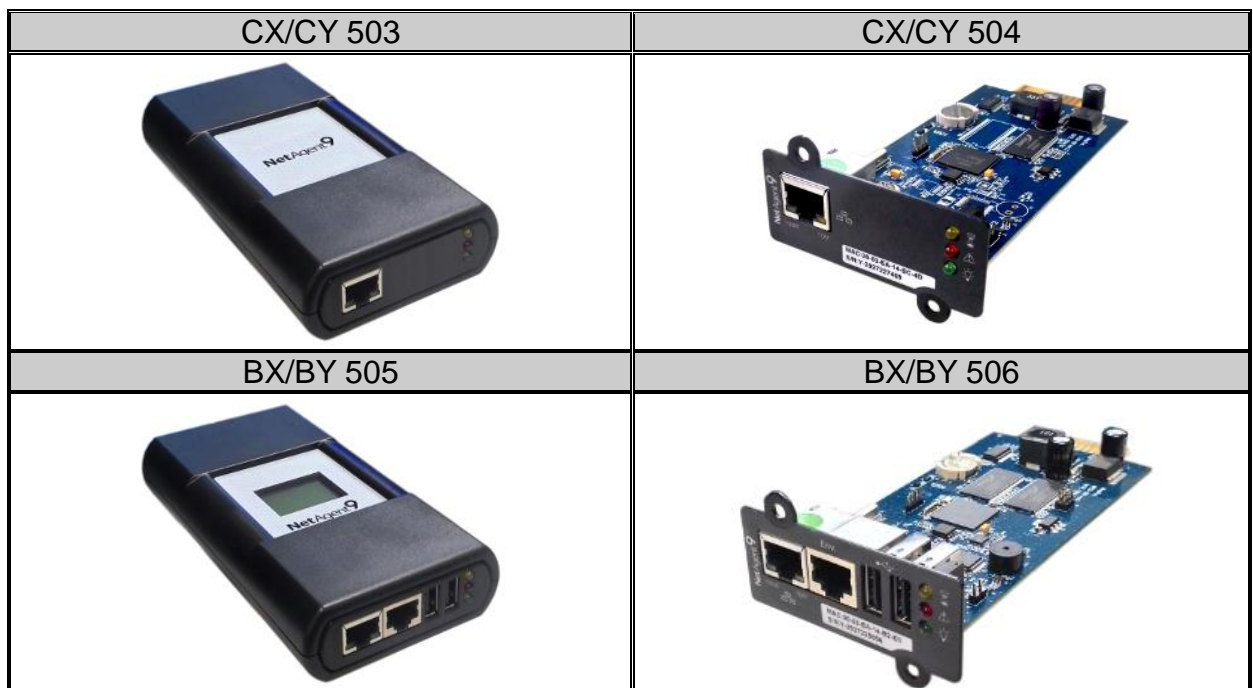

◆ One Port NetAgent 9

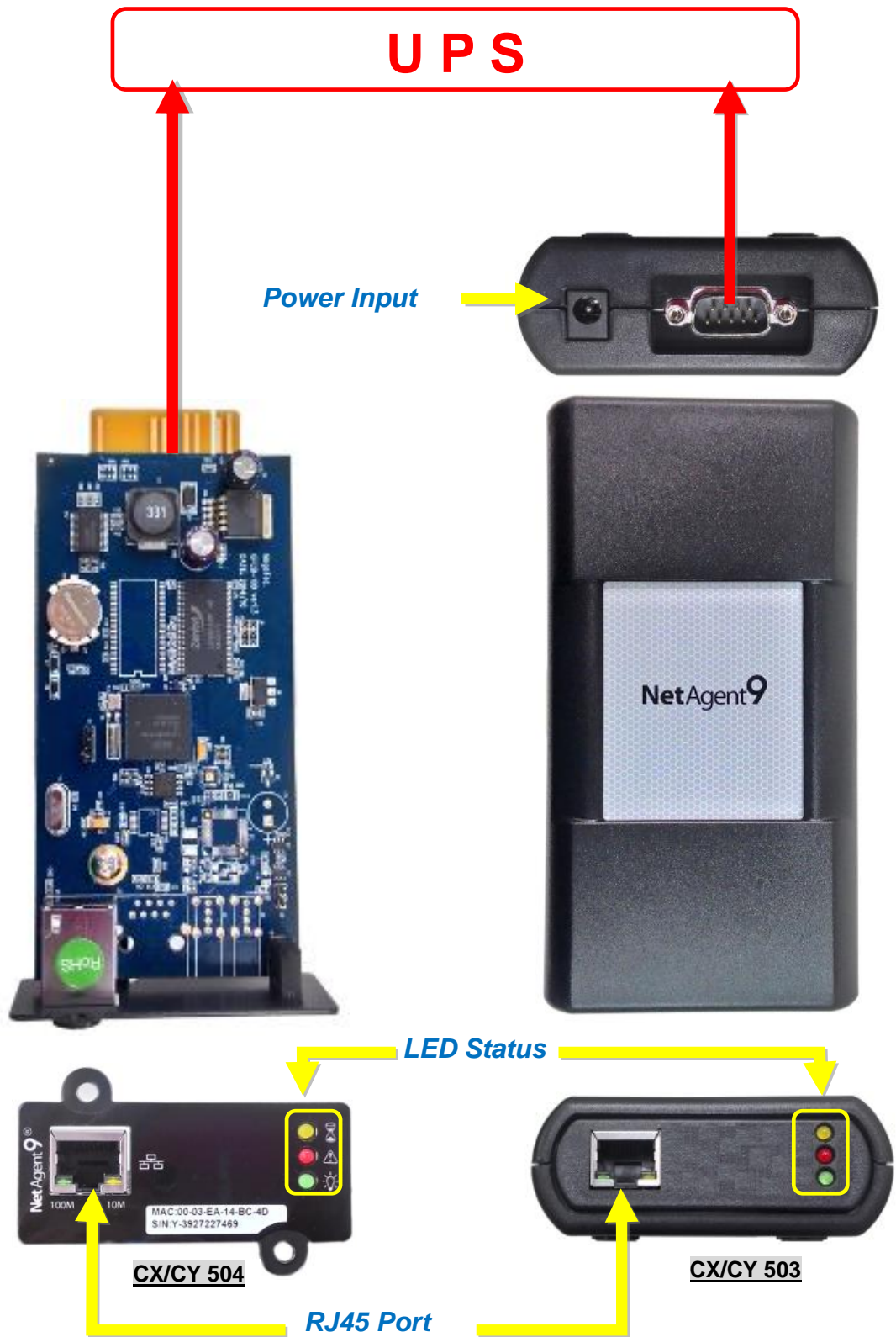

◆ NetAgent 9 W/USB Ports

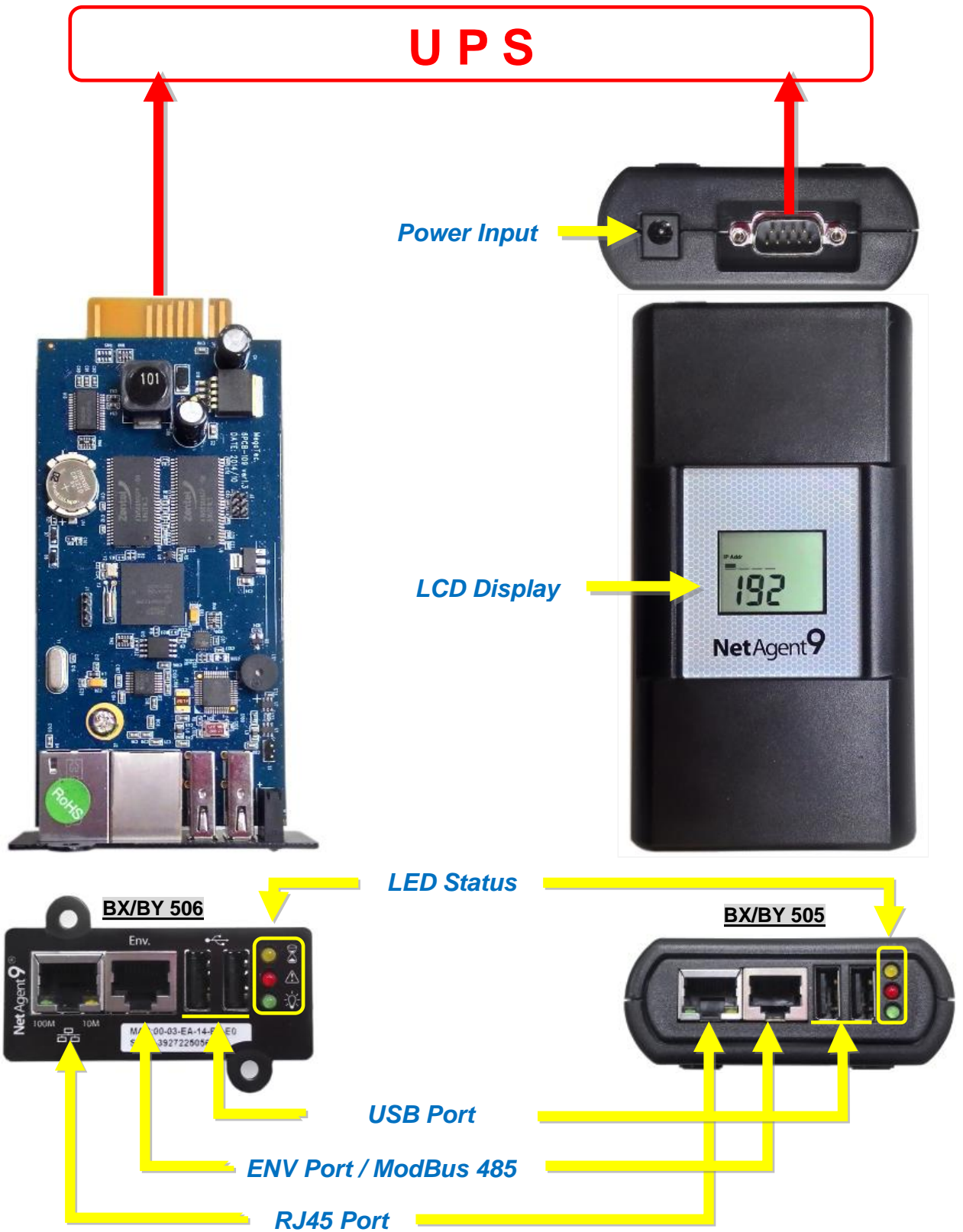

◆ NetAgent 9 USB Port Add-On

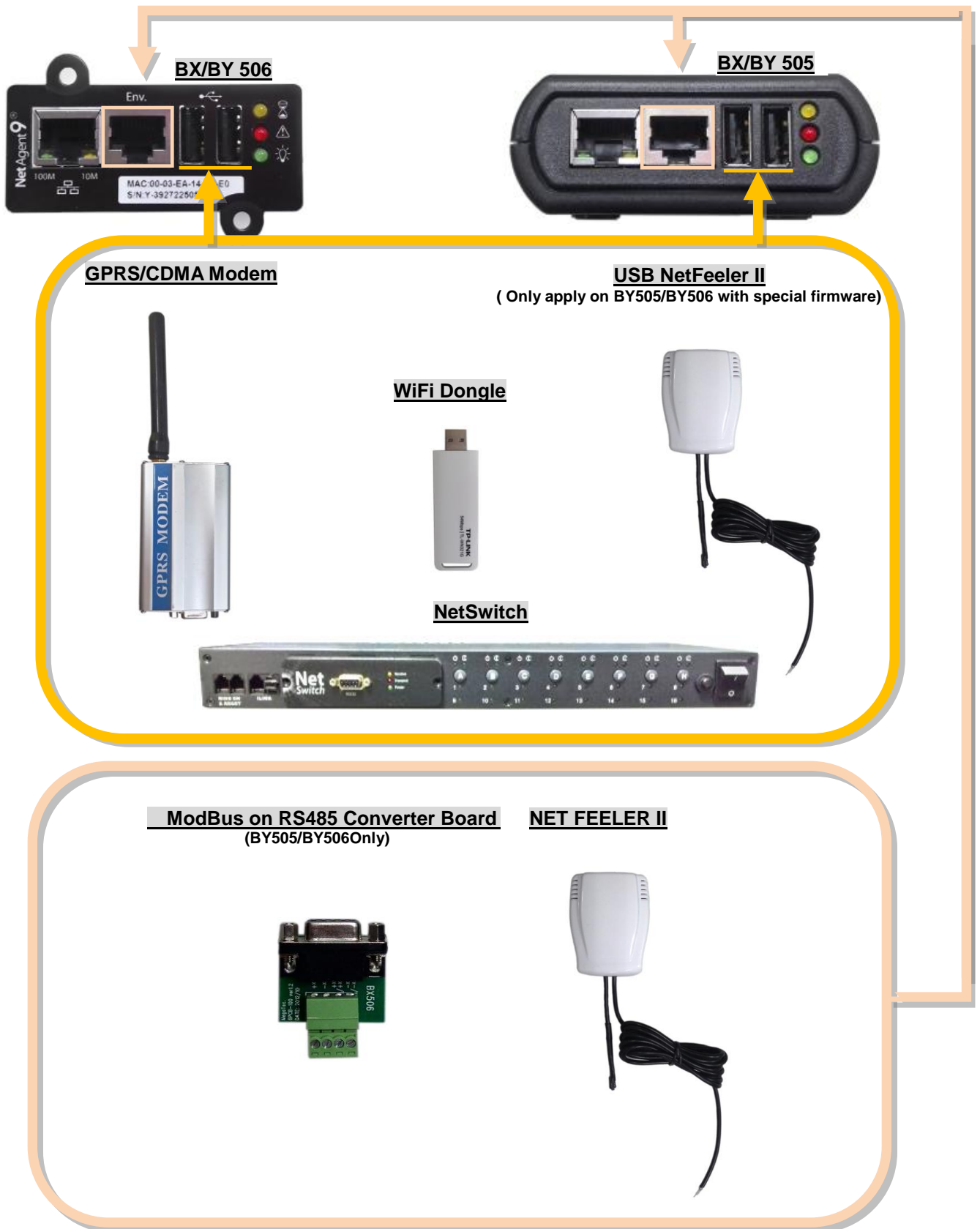

2.4.2 NetAgent 9 LED Indication

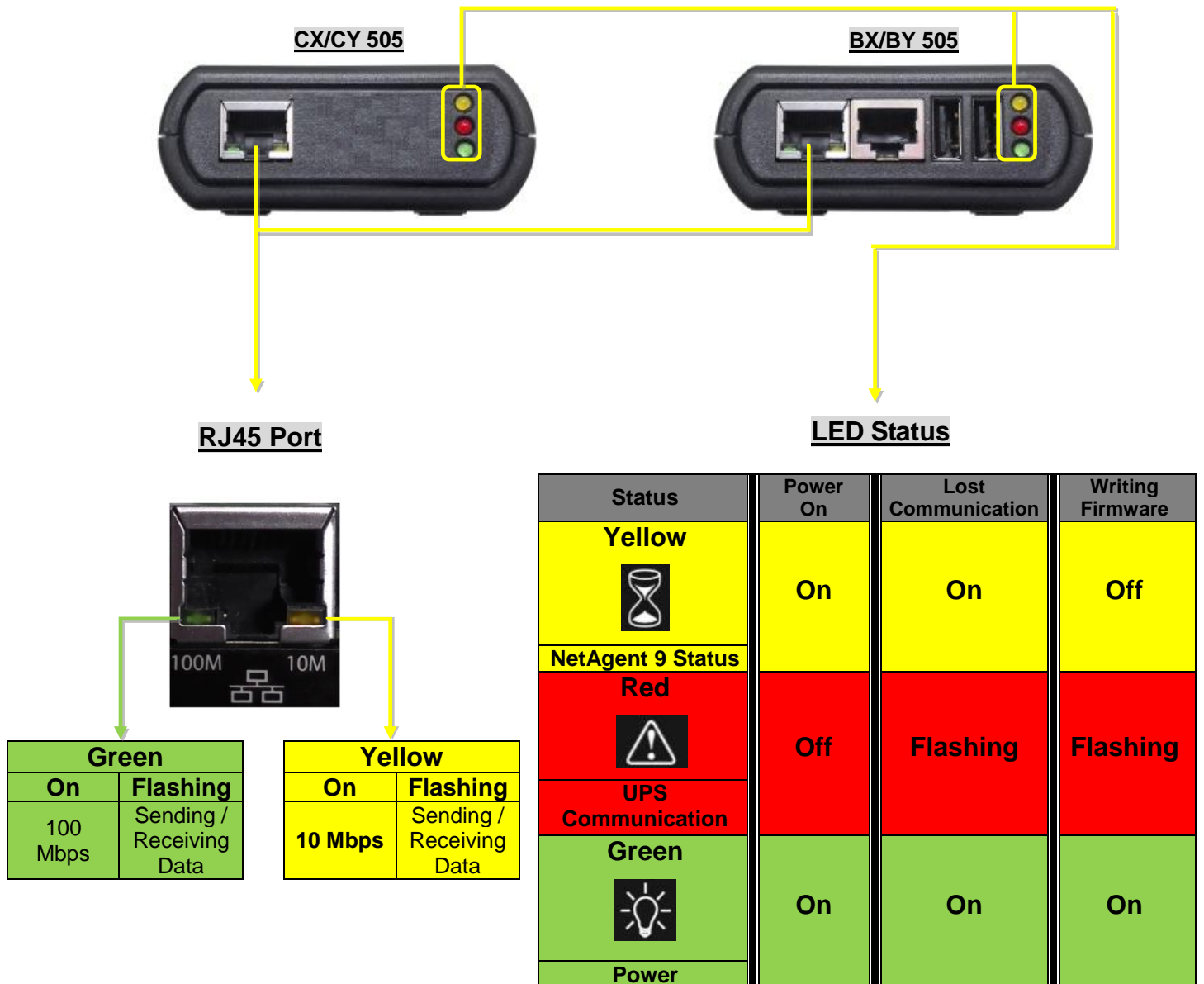

NOTE : When writing firmware, red led alternating flashing, DO NOT remove any power



2.5 NetAgent Mini 9 / NetAgent 9 Package Accessories

(1) Utility CD

CD Contents :



- **Netility** - NetAgent Software too – IP configuration / Firmware Upgrade
- **ClientMate** - Shutdown Software
- **SMS Server** - SMS Notification Software (with compatible Modem)
- **SNMPView** - NMS Software/ Multi Monitoring
- **Time Server** - Time Server Software
- **iMConfig** - Multi Configuration Software

(2) Quick Installation Guide (Optional)



(3) Adaptor



5.3V

For NetAgent Mini Series



9V

For NetAgent 9 Series

(4) ModBus On RS485 Coverter Board



(5) Cables

- **M2501** – For connection between NetAgent and dry contact UPS



- **M2502** – For connection between NetAgent and RS232 pin 6,7,9 UPS



- **M2505** – For connection between NetAgent and RS232 pin 2,3,5 UPS



- **M2506** – For connection between NetAgent and GPRS / CDMA modem



Chapter 3. NetAgent Installation

3.1 Hardware Installation

■ Internal NetAgent

☀ **NOTE : Turn Off UPS Power before installation**

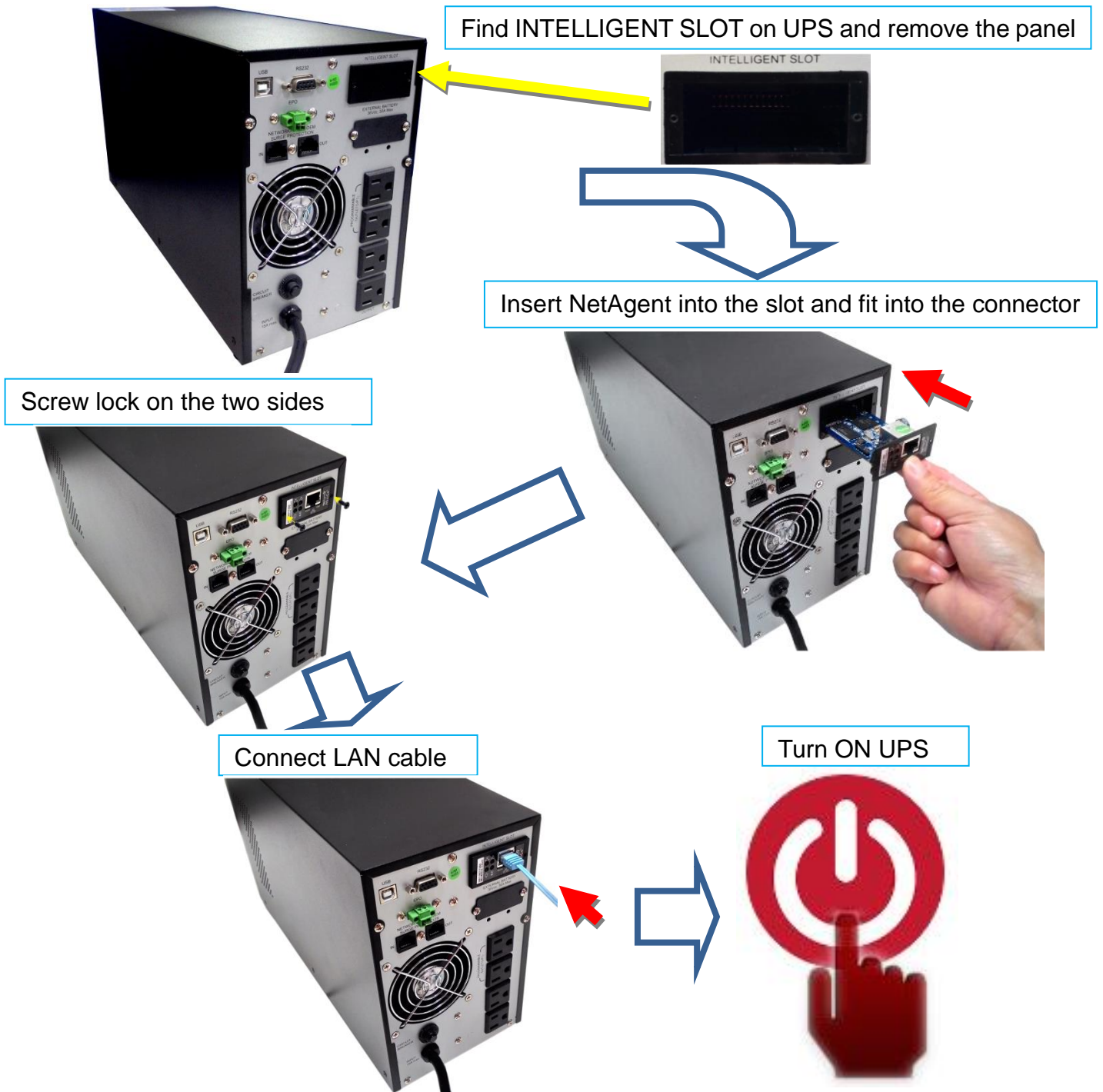

■ External NetAgent Mini

☀ **Turn Off UPS Power before installation**



Find RS232 port on UPS



Attach and screw NetAgent's RS232 connector on it

Connect LAN cable



Connect NetAgent Mini 5.3V adaptor



Turn ON UPS



■ External NetAgent II / 9

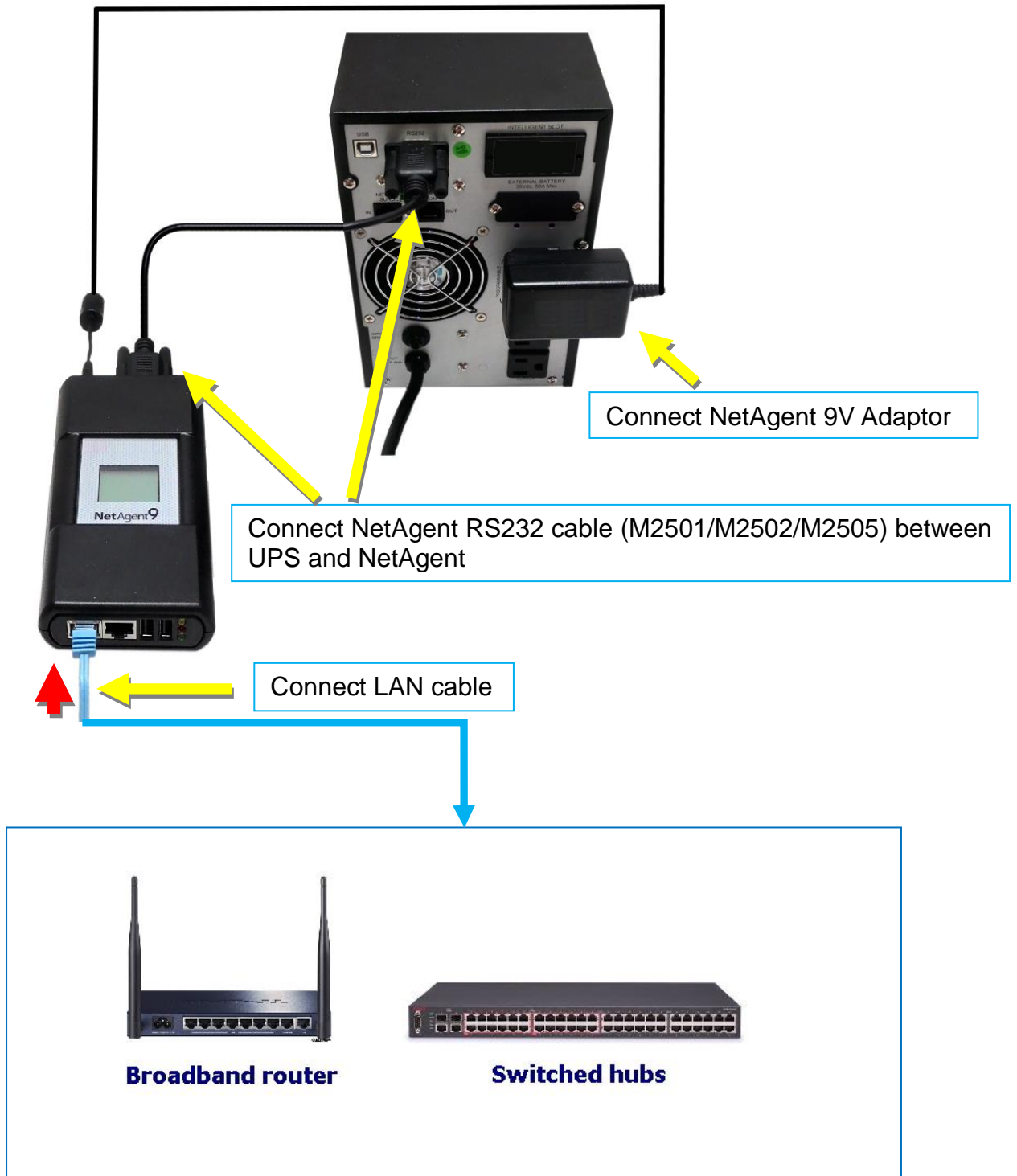

3.2 Software Installation

NetAgent Utility CD offers several management and shutdown software. Insert CD into CD-ROM and software can be select under **【Program Installation】**

Netility: Configure and Search NetAgent. Refer to 4.3

ClientMate: Shutdown OS Software. Refer to Chapter 6

SMS Server: SMS notification Softwar. Refer to Chapter 9

SNMPView : Multi monitoring Software. Refer to Chapter 7

Time Server: Time server software

iMConfig: Muti-configuration Software. Refer to Chapter 8

If the PC does not executes CD program automatically, please select from File Managment

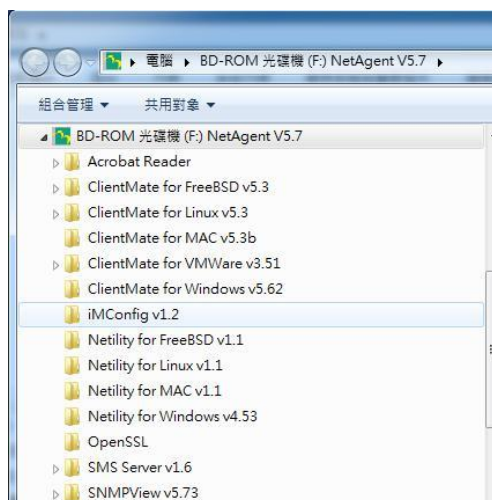

Chapter 4. NetAgent Setting

4.1 Introduction

NetAgent can be login via web or HyperTerminal with protocol and encryption of HTTP/HTTPS/SSH/Telnet. Enter the IP address of NetAgent to configure and monitor the UPS status.

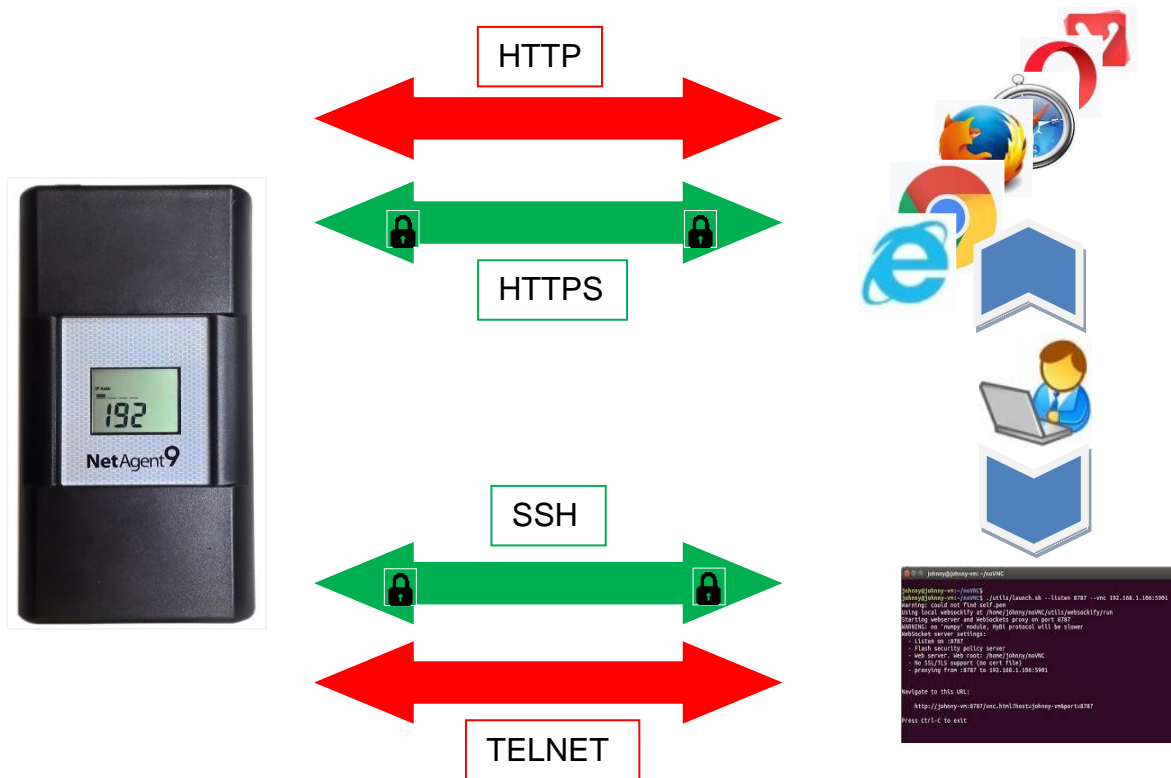

4.2 NetAgent Login Procedure

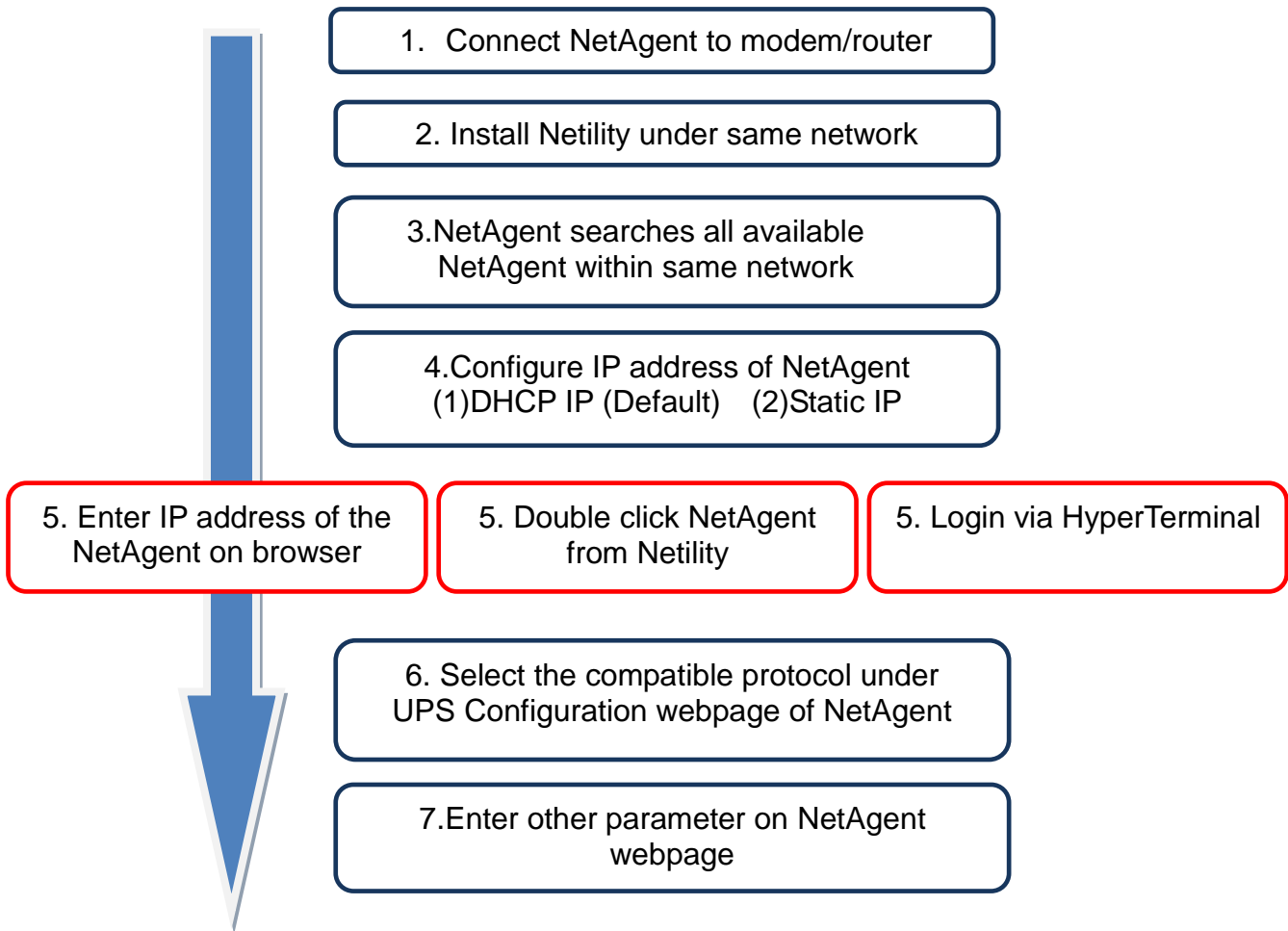

NOTE 1 : Each NetAgent has its unique serial number / MAC address and Password. This is available on the label of each unit. This helps to identify the card information on Netility



NOTE 2 : NetAgent with LCD display may obtain the IP info from it.

Example of LCD display format as below

IP address 192.168.0.70

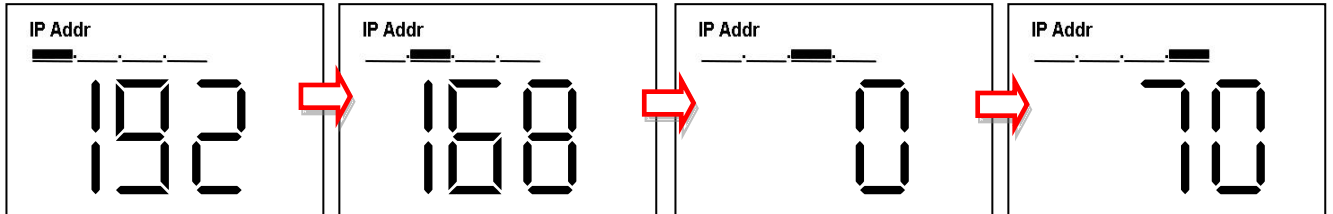

Subnet Mask: 255.255.255.0

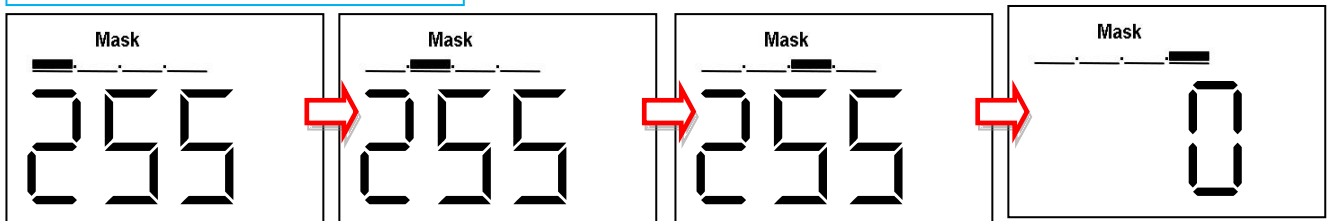

Gateway:192.168.0.1

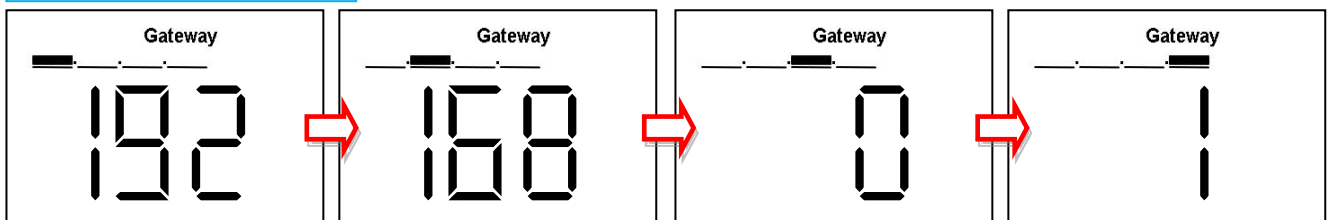

When NetAgent IP is known, enter such IP address on the browser to login. If non-LCD NetAgent model, install Netility software to find and configure its IP address.

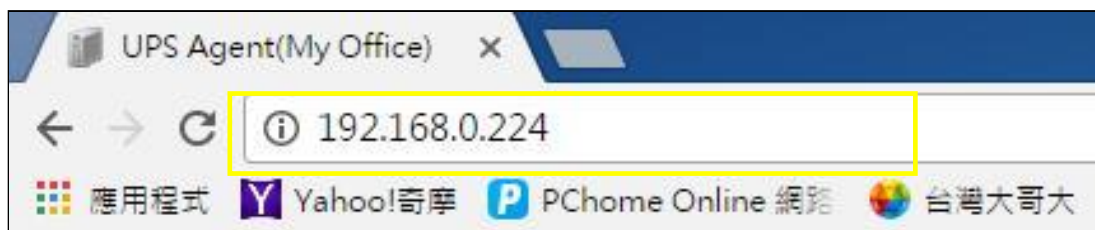

4.3 Netility Installation and Setting

■ Netility Installation

Netility is tool software that helps the user to search all the available NetAgent within network as well as to configure IP address and firmware upgrade. Mount the NetAgent Utility CD on CD-ROM and click on Program Installation>Netility>Windows v4.53



Netility installation directory

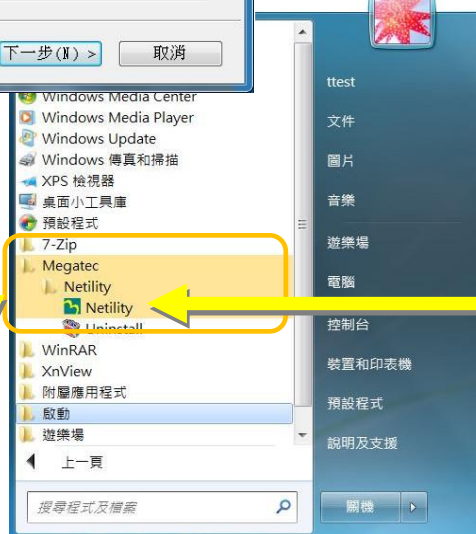

Netility Software

Under All Programs/ Megatec File Directory

■ Netility Operation and Setting

Netility main pages divided into 2 sections:

1. Online NetAgent List
2. Function Selection

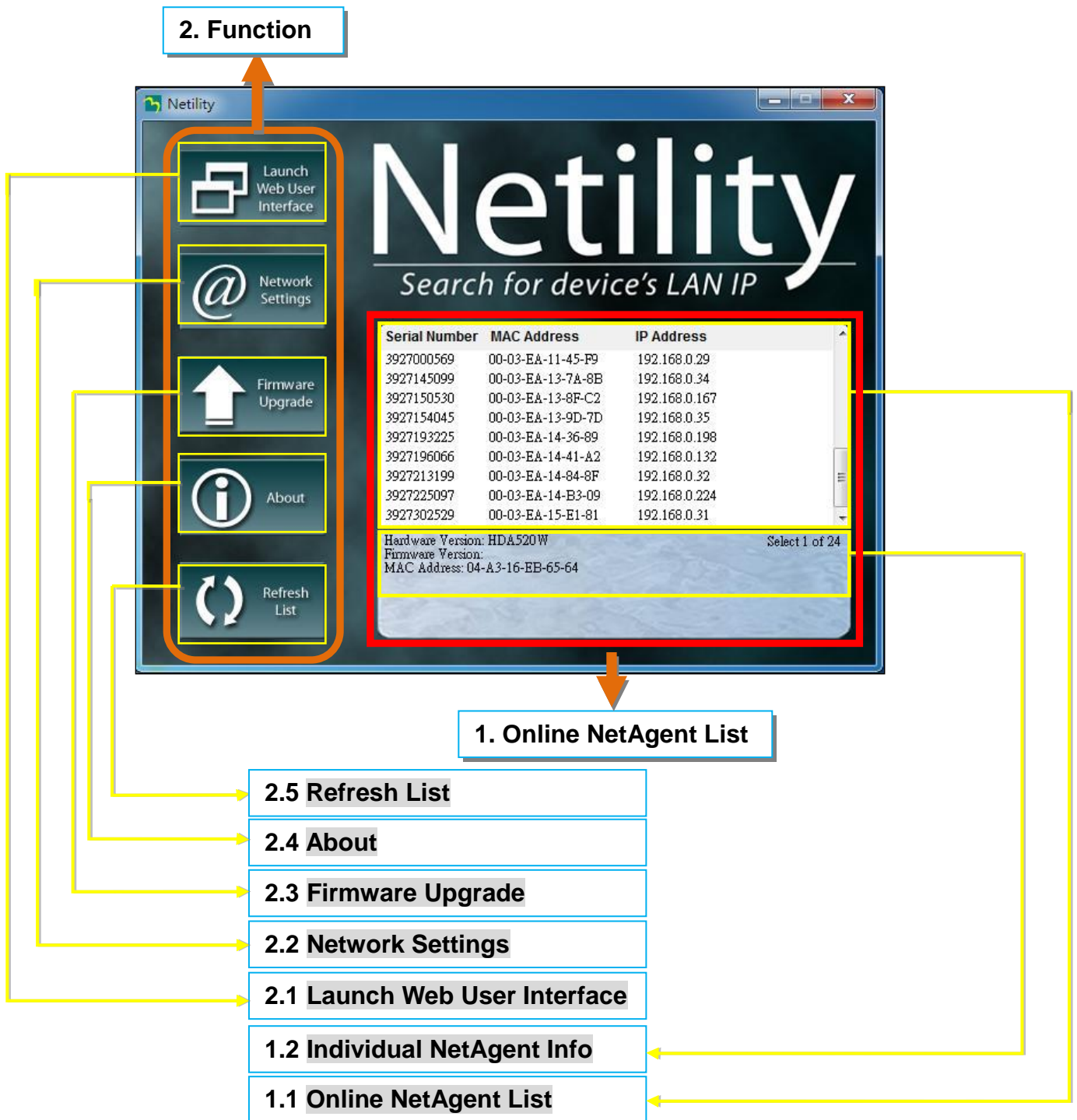

1.1 Online NetAgent List

When open up Netility , it automatically searches all the available online NetAgent within the network with its serial number, IP address, MAC address. Double click on the specific NetAgent with valid IP address, it will direct to the NetAgent's webpage. (List refreshes automatically every 2 minutes)

The top screenshot shows the Netility interface with a table of devices. The row with IP address 192.168.0.224 is highlighted in red. A blue arrow points from this row to the bottom screenshot.

Serial Number	MAC Address	IP Address
3927000569	00-03-EA-11-45-F9	192.168.0.29
3927145099	00-03-EA-13-7A-8B	192.168.0.34
3927150530	00-03-EA-13-8F-C2	192.168.0.167
3927154045	00-03-EA-13-9D-7D	192.168.0.35
3927193225	00-03-EA-14-36-89	192.168.0.198
3927196066	00-03-EA-14-41-A2	192.168.0.132
3927213199	00-03-EA-14-84-8F	192.168.0.32
3927225097	00-03-EA-14-B3-09	192.168.0.224
3927302529	00-03-EA-15-E1-81	192.168.0.31

Hardware Version: HDA520W Select 1 of 24

The bottom screenshot shows the same interface with the row for IP address 192.168.0.224 selected and highlighted in blue. A yellow arrow points to this row with a callout box that says "Double click to login to the webpage".

Serial Number	MAC Address	IP Address
3927000569	00-03-EA-11-45-F9	192.168.0.29
3927145099	00-03-EA-13-7A-8B	192.168.0.34
3927150530	00-03-EA-13-8F-C2	192.168.0.167
3927154045	00-03-EA-13-9D-7D	192.168.0.35
3927193225	00-03-EA-14-36-89	192.168.0.198
3927196066	00-03-EA-14-41-A2	192.168.0.132
3927213199	00-03-EA-14-84-8F	192.168.0.32
3927225097	00-03-EA-14-B3-09	192.168.0.224
3927302529	00-03-EA-15-E1-81	192.168.0.31

Hardware Version: HBY506
Firmware Version: 3.5.BY506
MAC Address: 00-03-EA-14-B3-09 Select 1 of 23

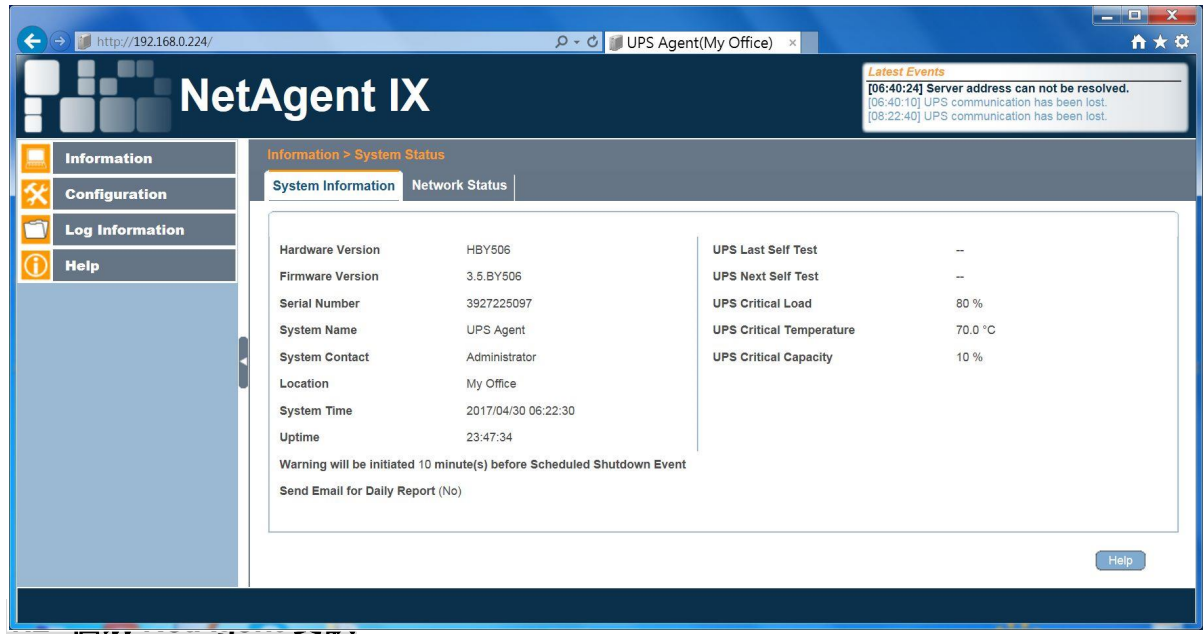

1.2 Individual NetAgent Info

Click on specific NetAgent, the bottom column shows its hardware, firmware version and MAC address. It also shows the total NetAgent number that found by Netility and selected

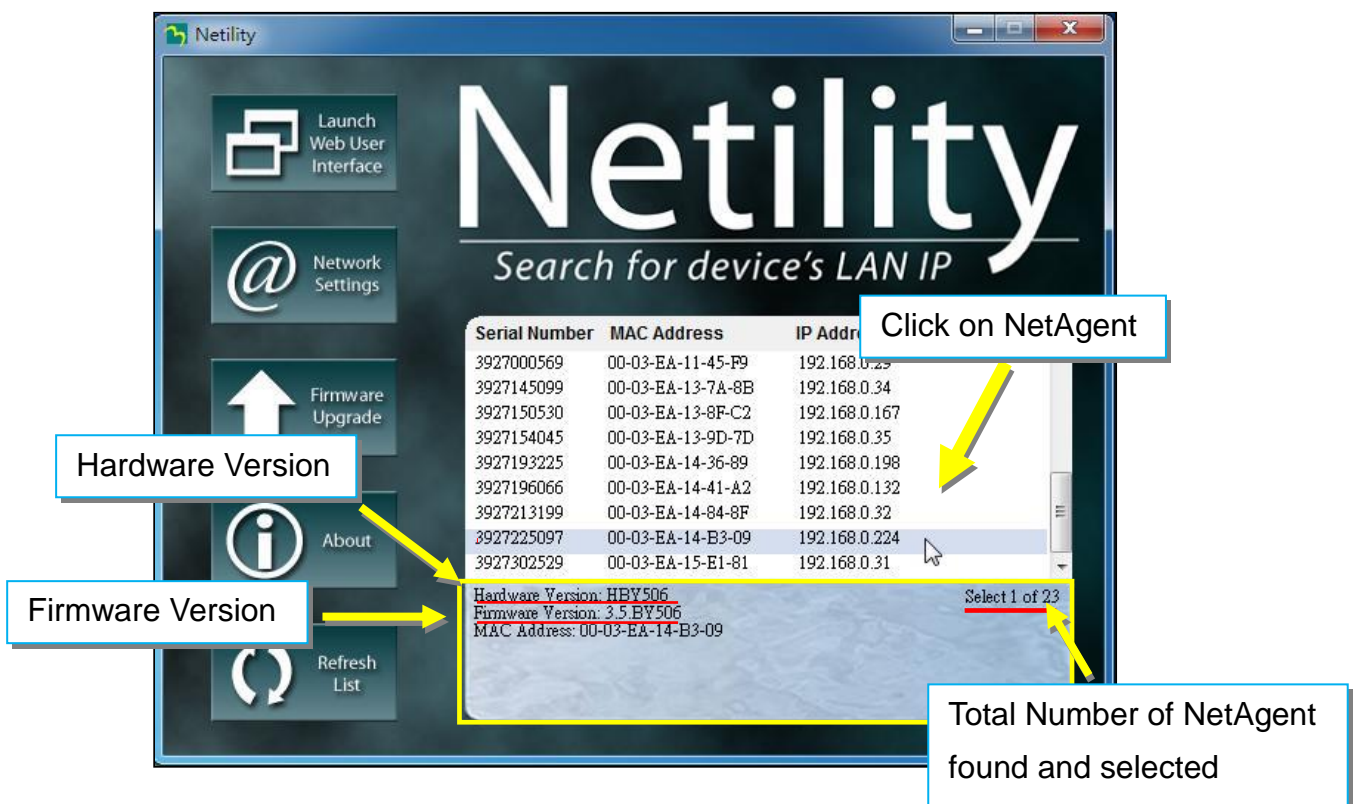

2.1 Launch Web User Interface

Select specific NetAgent from the list and click on Launch Web User Interface to login to the NetAgent's webpage

2. Click on Launch Web User Interface

1. Click on NetAgent

Serial Number	MAC Address	IP Address
3927000569	00-03-EA-11-45-F9	192.168.0.29
3927145099	00-03-EA-13-7A-8B	192.168.0.34
3927150530	00-03-EA-13-8F-C2	192.168.0.167
3927154045	00-03-EA-13-9D-7D	192.168.0.35
3927193225	00-03-EA-14-36-89	192.168.0.198
3927196066	00-03-EA-14-41-A2	192.168.0.132
3927213199	00-03-EA-14-84-8F	192.168.0.32
3927225097	00-03-EA-14-B3-09	192.168.0.224
3927302529	00-03-EA-15-E1-81	192.168.0.31

Hardware Version: HBY506
Firmware Version: 3.5.BY506
MAC Address: 00-03-EA-14-B3-09

Select 1 of 23



Login to the webpage of such NetAgent

NetAgent IX

Information > System Status

System Information	Network Status
Hardware Version: HBY506	UPS Last Self Test: --
Firmware Version: 3.5.BY506	UPS Next Self Test: --
Serial Number: 3927225097	UPS Critical Load: 80 %
System Name: UPS Agent	UPS Critical Temperature: 70.0 °C
System Contact: Administrator	UPS Critical Capacity: 10 %
Location: My Office	
System Time: 2017/04/30 07:08:10	
Uptime: 1 day(s) 00:33:15	

Warning will be initiated 10 minute(s) before Scheduled Shutdown Event

Send Email for Daily Report (No)

Help

2.2 Network Settings

- When connecting the NetAgent for the first time, ensure IP address and other network setting are correctly entered in order to login to the NetAgent's webpage via browser or HyperTerminal
- When select to obtain IP address by DHCP or BOOTP, IP address and other network parameter will be assign by the network
- NetAgent offers 4 network protocols - HTTP / HTTPS / TELNET / SSH for management with security consideration. If any change on port number, the it require to enter the full IP address with port number in order to login
For example : HTTP port number change to 81
The full address to be enter on browser should be "http://X.X.X.X:81"
(X.X.X.X is the IP address of the NetAgent)
For Example : Telnet port number change to 24
The full address to be enter on HyperTerminal should be "http://X.X.X.X 24" (X.X.X.X is the IP address of the NetAgent)
- When password of the NetAgent is enabled, it is necessary to enter the correct password before making any configuration change and firmware upgrade

The image shows a screenshot of the Netility web interface with several callouts and annotations. The main interface has a sidebar with buttons for 'Launch Web User Interface', 'Network Settings', 'Firmware Upgrade', and 'About'. A table of device information is displayed, and a 'Configure' dialog box is open for IP address configuration.

1. Click on specific NetAgent

2. Click on Network Settings

Serial Number	MAC Address	IP Address
3926444847	00-03-EA-08-CB-2F	192.168.1.107
3927177694	00-03-EA-13-F9-DE	192.168.1.105
3927225097	00-03-EA-14-B3-09	169.254.70.73

Select to assign IP by DHCP

Columns requires to be entered for Static IP address

Configure dialog box (IP Address tab):

- Obtain IP address by DHCP
- Obtain IP address by BOOTP
- Use following Static IP address

Static IP Address fields:

- IP Address: 192 . 168 . 1 . 110
- Subnet Mask: 255 . 255 . 255 . 0
- Gateway: 192 . 168 . 1 . 1

Buttons: 確定 (OK), 取消 (Cancel)

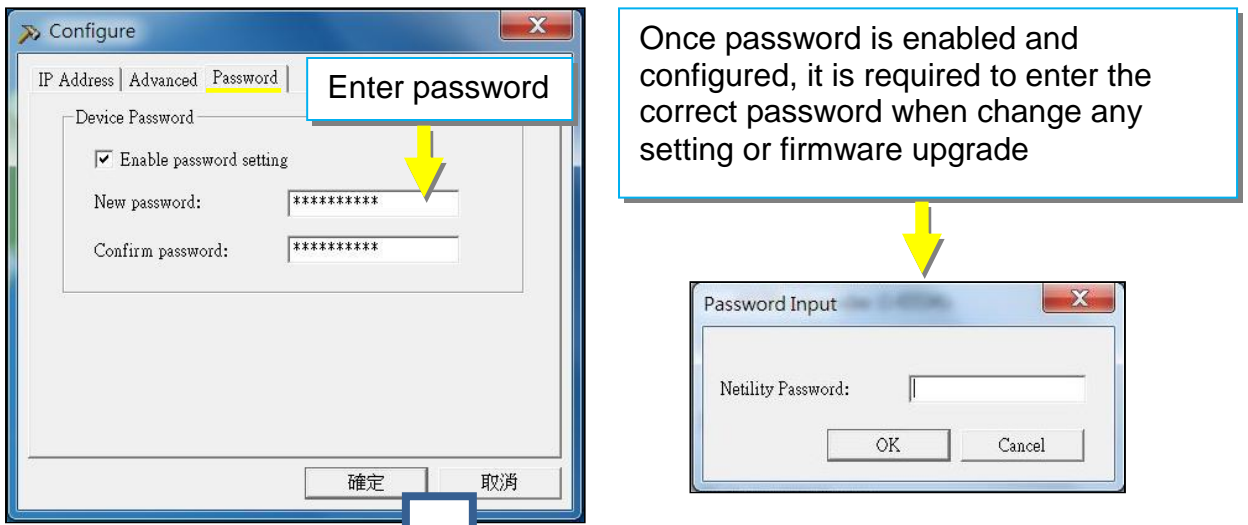
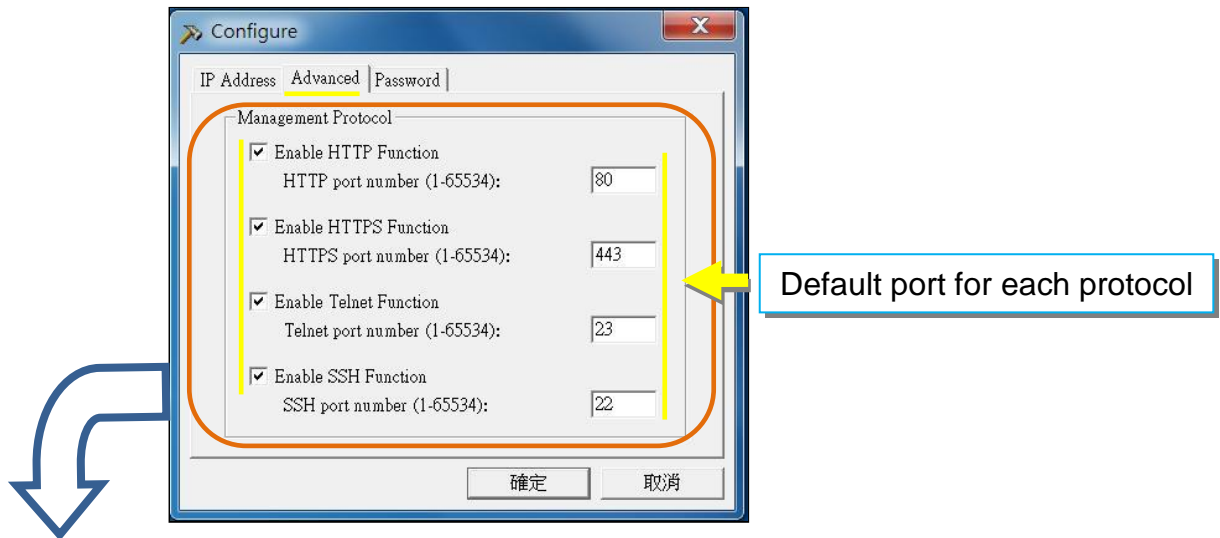

2.3 Firmware Upgrade

- This is to upgrade or re-load the firmware to the NetAgent unit. Firmware version is available on the official website. Ensure to check the NetAgent model, hardware version for the correct firmware version (.bin)
- Ways to select NetAgent for firmware upgrading
 - (1) Click on specific NetAgent from the Netility list
 - (2) Press and hold on CTRL key then select multi NetAgent unit from the list=>This is to upgrade multi units at once
 - (3) Click on the first NetAgent from the list, then press and hold on SHIFT key as well as click on the last unit of the NetAgent =>This is if all NetAgent from the list are same model

⚠ WARNING : Please makes sure the multi NetAgent selected are same model

- If any failure during firmware upgrading, please upgrade again until it is successfully done
- While upgrading, red and yellow LED would alternating flashing, or red led flashing. DO NOT remove any power or cable to the NetAgent. Once firmware is successfully upgraded, NetAgent would reboot automatically.

Upgrade Single NetAgent

Selection of Multi-NetAgent

Upgrade consecutive NetAgent

1. Select .bin file

2. Click on Download

3. Upgrade message

4. Cancel to exit

Serial Number	MAC Address	IP Address
3927000569	00-03-EA-11-45-F9	192.168.0.29
3927145099	00-03-EA-13-7A-8B	192.168.0.34
3927150530	00-03-EA-13-8F-C2	192.168.0.167
3927154045	00-03-EA-13-9D-7D	192.168.0.35
3927193225	00-03-EA-14-36-89	192.168.0.198
3927196066	00-03-EA-14-41-A2	192.168.0.132
3927213199	00-03-EA-14-84-8F	192.168.0.32
3927225097	00-03-EA-14-B3-09	192.168.1.110
3927302529	00-03-EA-15-E1-81	192.168.0.31

Serial Number	MAC Address	IP Address
384529183	04-A3-16-EB-73-1F	192.168.0.218
3925868676	00-03-EA-00-00-84	192.168.0.250
3925868682	00-03-EA-00-00-8A	192.168.0.106
3925868686	00-03-EA-00-00-8E	192.168.0.107
3925868916	00-03-EA-00-01-74	192.168.0.28
3925980505	00-03-EA-01-B5-59	192.168.0.115
3925989976	00-03-EA-01-DA-58	192.168.0.112
3925989885	00-03-EA-01-FD-25	192.168.0.212
3925989885	00-03-EA-03-72-12	192.168.0.175

Serial Number	MAC Address	IP Address
384529183	04-A3-16-EB-73-1F	192.168.0.218
3925868676	00-03-EA-00-00-84	192.168.0.250
3925868682	00-03-EA-00-00-8A	192.168.0.106
3925868686	00-03-EA-00-00-8E	192.168.0.107
3925868916	00-03-EA-00-01-74	192.168.0.28
3925980505	00-03-EA-01-B5-59	192.168.0.115
3925989976	00-03-EA-01-DA-58	192.168.0.112
3925989885	00-03-EA-01-FD-25	192.168.0.212
3925989885	00-03-EA-03-72-12	192.168.0.175

Device	Download Status
3927225097	Download Successfully

2.4 About

Here shows the current Netility version



2.5 Refresh List

The list on Netility would refresh every 2 minutes automatically, however, manual refresh is also possible by clicking Refresh List



4.4 NetAgent Setting

4.4.1 Web Interface

NetAgent 9 Mini & NetAgent 9

The screenshot shows the NetAgent IX web interface. The browser address bar displays <http://192.168.0.224/> and the page title is "UPS Agent(My Office)". The interface features a navigation menu on the left with options: Information, Configuration, Log Information, and Help. The main content area is titled "Information > System Status" and contains two tabs: "System Information" and "Network Status".

System Information

Hardware Version	HBY506	UPS Last Self Test	--
Firmware Version	3.5.BY506	UPS Next Self Test	--
Serial Number	3927225097	UPS Critical Load	80 %
System Name	UPS Agent	UPS Critical Temperature	70.0 °C
System Contact	Administrator	UPS Critical Capacity	10 %
Location	My Office		
System Time	2017/04/30 06:22:30		
Uptime	23:47:34		

Warning will be initiated 10 minute(s) before Scheduled Shutdown Event
Send Email for Daily Report (No)

Network Status

MAC Address	00:03:EA:02:9F:E3	Primary DNS Server	192.168.0.1
Connection Type	100Mbps Full-Duplex	Secondary DNS Server	
IP Address	192.168.0.106	Time Server	time.nist.gov
Subnet Mask	255.255.255.0	PPPoE IP	
Gateway	192.168.0.1		
Email Server			

Latest Events

- [06:40:24] Server address can not be resolved.
- [06:40:10] UPS communication has been lost.
- [08:22:40] UPS communication has been lost.

Help

NetAgent Mini & NetAgent II

The screenshot shows the NetAgent web interface. The browser address bar displays <http://192.168.0.106/> and the page title is "BP506(TTEST)". The interface features a navigation menu on the left with options: Information, Configuration, Log Information, and Help. The main content area is titled "System Information" and contains two tabs: "System Information" and "Network Status".

System Information

Hardware Version	HBP506	UPS Last Self Test	--
Firmware Version	2.48.BP506.EAST	UPS Next Self Test	--
Serial Number	3926040547	UPS Critical Load	80 %
System Name	BP506	UPS Critical Temperature	70.0 °C
System Contact	Administrator	UPS Critical Capacity	10 %
Location	TTEST		
System Time	2017/04/30 06:36:18		
Uptime	00:42:19		

Warning will be initiated 10 minute(s) before Scheduled Shutdown Event
Send Email for Daily Report (No)

Network Status

MAC Address	00:03:EA:02:9F:E3	Primary DNS Server	192.168.0.1
Connection Type	100Mbps Full-Duplex	Secondary DNS Server	
IP Address	192.168.0.106	Time Server	time.nist.gov
Subnet Mask	255.255.255.0	PPPoE IP	
Gateway	192.168.0.1		
Email Server			

Help

■ Web Interface Display



4.4.2 NetAgent Option Directory Structure

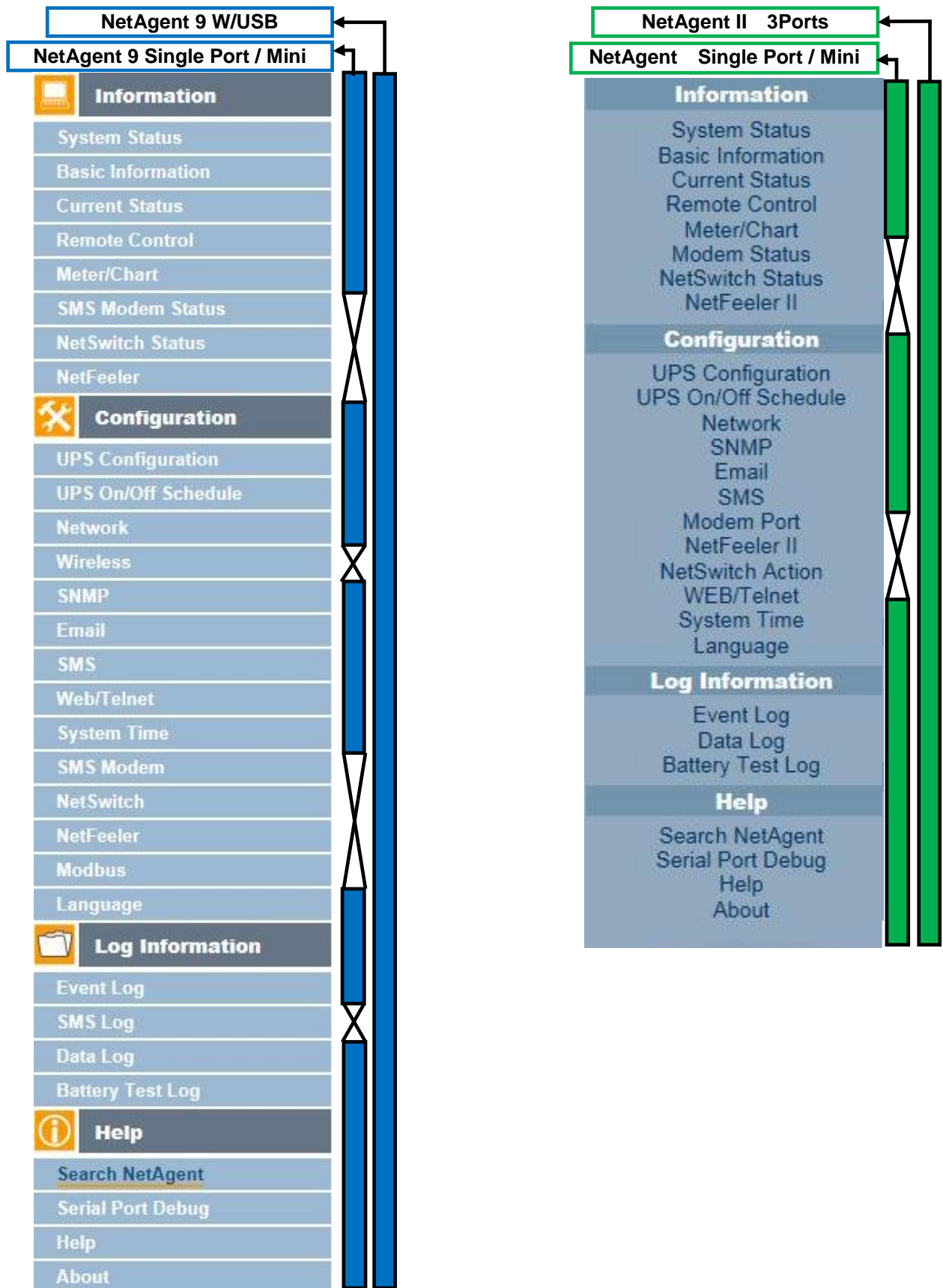

4.4.3 NetAgent Setting Options

- Information > System Status
- **System Information**

Here shows all the basic information of the NetAgent such as hardware / firmware version; Serial Number; Uptime...etc.

NetAgent 9 Mini & NetAgent 9

The screenshot shows the NetAgent IX web interface in a browser window. The address bar shows 'http://192.168.0.224/'. The page title is 'NetAgent IX'. A 'Latest Events' box in the top right corner contains the following text:

```
[06:40:24] Server address can not be resolved.
[06:40:10] UPS communication has been lost.
[08:22:40] UPS communication has been lost.
```

The main content area is titled 'Information > System Status' and has two tabs: 'System Information' (selected) and 'Network Status'. The 'System Information' tab displays the following data:

Hardware Version	HBY506	UPS Last Self Test	--
Firmware Version	3.5.BY506	UPS Next Self Test	--
Serial Number	3927225097	UPS Critical Load	80 %
System Name	UPS Agent	UPS Critical Temperature	70.0 °C
System Contact	Administrator	UPS Critical Capacity	10 %
Location	My Office		
System Time	2017/04/30 07:08:10		
Uptime	1 day(s) 00:33:15		

Below the table, there is a warning message: 'Warning will be initiated 10 minute(s) before Scheduled Shutdown Event' and a checkbox for 'Send Email for Daily Report (No)'. A 'Help' button is located at the bottom right of the main content area.

NetAgent Mini & NetAgent II

The screenshot shows the NetAgent web interface. The page title is 'NetAgent' and the sub-page title is 'System Status'. The left sidebar contains a navigation menu with the following items:

- Information
 - System Status
 - Basic Information
 - Current Status
 - Remote Control
 - Meter/Chart
 - Modem Status
 - NetSwitch Status
 - NetFeeler II
- Configuration
- Log Information
- Help

The main content area displays 'System Information' and 'Network Status' tables. The 'System Information' table is highlighted with a yellow border and contains the following data:

Hardware Version	HBP506	UPS Last Self Test	--
Firmware Version	2.48.BP506.EAST	UPS Next Self Test	--
Serial Number	3926040547	UPS Critical Load	80 %
System Name	UPS Agent	UPS Critical Temperature	70.0 °C
System Contact	Administrator	UPS Critical Capacity	10 %
Location	My Office		
System Time	2017/05/01 13:20:14		
Uptime	00:03:37		

Below the table, there is a warning message: 'Warning will be initiated 10 minute(s) before Scheduled Shutdown Event' and a checkbox for 'Send Email for Daily Report (No)'. The 'Network Status' table contains the following data:

MAC Address	00:03:EA:02:9F:E3	Primary DNS Server	192.168.0.1
Connection Type	100Mbps Full-Duplex	Secondary DNS Server	
IP Address	192.168.0.106	Time Server	time.nist.gov
Subnet Mask	255.255.255.0	PPPoE IP	
Gateway	192.168.0.1		
Email Server			

A 'Help' button is located at the bottom right of the main content area.

- **Network Status**

This page shows the network information of the NetAgent. With NetAgent9 series which supports IPv6 could work with compatible network appliance.

NetAgent 9 Mini & NetAgent 9

The screenshot shows the 'System Status' page for NetAgent 9. The left sidebar contains navigation options: Information (System Status, Basic Information, Current Status, Remote Control, Meter/Chart, SMS Modem Status, NetSwitch Status, NetFeeler), Configuration, Log Information, and Help. The main content area is titled 'Information > System Status' and has two tabs: 'System Information' and 'Network Status'. The 'Network Status' tab is active, displaying four panels: Ethernet, General, IPv4, and IPv6.

Ethernet		General	
MAC Address	00:03:EA:14:B3:09	Email Server	
Connection Type	100Mbps Full-Duplex	Time Server	time.nist.gov
		PPPoE IP	
		PPPoE IPv6	

IPv4		IPv6	
IP Address	192.168.0.224	IP Address	
Subnet Mask	255.255.255.0	LinkLocal Address	fe80::203:eaff:fe14:b309/64
Gateway	192.168.0.2	6to4 Address	
Primary DNS Server	192.168.0.2	Gateway	
Secondary DNS Server		Primary DNS Server	
		Secondary DNS Server	

A 'Help' button is located at the bottom right of the page.

NetAgent Mini & NetAgent II

The screenshot shows the 'System Status' page for NetAgent Mini & NetAgent II. The left sidebar contains navigation options: Information (System Status, Basic Information, Current Status, Remote Control, Meter/Chart, Modem Status, NetFeeler II), Configuration, Log Information, and Help. The main content area is titled 'NetAgent System Status' and has two tabs: 'System Information' and 'Network Status'. The 'Network Status' tab is active and highlighted with a yellow border, displaying network configuration details.

System Information			
Hardware Version	HBP506	UPS Last Self Test	--
Firmware Version	2.48.BP506.EAST	UPS Next Self Test	--
Serial Number	3926040547	UPS Critical Load	80 %
System Name	UPS Agent	UPS Critical Temperature	70.0 °C
System Contact	Administrator	UPS Critical Capacity	10 %
Location	My Office		
System Time	2017/05/01 13:20:14		
Uptime	00:03:37		

Warning will be initiated 10 minute(s) before Scheduled Shutdown Event
Send Email for Daily Report (No)

Network Status			
MAC Address	00:03:EA:02:9F:E3	Primary DNS Server	192.168.0.1
Connection Type	100Mbps Full-Duplex	Secondary DNS Server	
IP Address	192.168.0.106	Time Server	time.nist.gov
Subnet Mask	255.255.255.0	PPPoE IP	
Gateway	192.168.0.1		
Email Server			

A 'Help' button is located at the bottom right of the page.

■ **Information > Basic Information**

This page shows UPS information/Battery Information/Rating Information. The data is obtained from the reply of UPS or the settings from [UPS Configuration] webpage

NetAgent 9 Mini & NetAgent 9

Information > Basic Information

UPS Information	
UPS Manufacturer	Megatec_UPS
UPS Firmware Version	20170001
UPS Model	BEST_UPS

Battery Information	
Date of last battery replacement	2016/01/01
Number of Batteries	2
Battery Charge Voltage	2.267 V

Rating Information	
Voltage Rating	220.0 V
Frequency Rating	50.0 Hz
Battery Voltage Rating	24.01 V

[Help](#)

NetAgent Mini & NetAgent II

NetAgent Basic Information

UPS Information	
UPS Manufacturer	Megatec_UPS
UPS Firmware Version	20170001
UPS Model	BEST_UPS

Battery Information	
Date of last battery replacement	2006/01/01
Number of Batteries	2
Battery Charge Voltage	2.267V

Rating Information	
Voltage Rating	220.0V
Frequency Rating	50.0Hz
Battery Voltage Rating	24.01V

[Help](#)

■ **Information > Current Status**

This page shows current UPS Input / Output and Battery Status. Status refresh time can be configured. When abnormal condition occurs, it shows in red.

NetAgent 9 Mini & NetAgent 9

The screenshot shows the 'Information > Current Status' page. On the left is a navigation menu with categories: Information (System Status, Basic Information, Current Status, Remote Control, Meter/Chart, SMS Modem Status, NetSwitch Status, NetFeeler), Configuration, Log Information, and Help. The main content area has tabs for 'Input Status', 'Output Status', and 'Battery Status'. Under 'Input Status', there is a table:

AC Status	Normal	
Input Line Voltage	220.1 V	
Input Max. Line Voltage	220.1 V	
Input Min. Line Voltage	220.1 V	
Input Frequency	50.0 Hz	

Below the table, 'UPS Status' is shown as 'UPS Normal'. A dropdown menu for 'Refresh status every' is open, showing options: 2 seconds, 5 seconds, 10 seconds (selected), 30 seconds, and 1 minute. A 'Help' button is visible. A yellow box highlights the 'Refresh status every' dropdown, and a yellow arrow points to it from the dropdown menu.

NetAgent Mini & NetAgent II

The screenshot shows the 'NetAgent' interface with the 'Current Status' page. The left navigation menu includes: Information (System Status, Basic Information, Current Status, Remote Control, Meter/Chart, Modem Status, NetFeeler II), Configuration, Log Information, and Help. At the top right, it says 'Current Status'. Below the navigation, there is a 'Refresh status every' dropdown set to '10 seconds'. The main content area displays the following status information:

UPS Status: UPS Normal

Input Status

AC Status	On Battery
Input Line Voltage	220.1 V
Input Max. Line Voltage	220.1 V
Input Min. Line Voltage	220.1 V
Input Frequency	50.0 Hz

Output Status

Output Voltage	220.1 V
Output Status	On Battery
UPS load	30 %

Battery Status

Temperature	30.1 °C (86.1 °F)
Battery Status	Battery Low
Battery Capacity	100 %
Battery Voltage	325.2 V
Time on Battery	00:02:14
Estimated Battery Remaining Time	1 day(s) 09:20:00
UPS Last Self Test	--
UPS Next Self Test	--

A 'Help' button is located at the bottom right.

Information > Remote Control

Here, user can perform several test to the UPS remotely. Once the option is selected, please click on Apply in order to execute it.

NetAgent 9 Mini & NetAgent 9

The screenshot displays the 'Information > Remote Control' interface for NetAgent 9. On the left is a navigation menu with categories: Information (System Status, Basic Information, Current Status, Remote Control, Meter/Chart, SMS Modem Status, NetSwitch Status, NetFeeler), Configuration, Log Information, and Help. The main content area is titled 'Information > Remote Control' and contains two sections: 'UPS Testing' and 'Miscellaneous'. The 'UPS Testing' section has radio buttons for '10-Second Test' (selected), 'Deep Battery Test for 10 minute(s)', 'Test until battery capacity below 10 %', 'Test Until Battery Low', and 'Cancel Test'. The 'Miscellaneous' section has radio buttons for 'Turn off UPS when AC power Fails', 'Put UPS in Sleep mode for 60 minute(s)', 'Wake up UPS', 'Reboot UPS', and 'UPS Buzzer On/Off'. At the bottom, a 'Select and Apply' callout box with a yellow arrow points to the 'Apply' button, which is highlighted with a yellow border. Other buttons 'Reset' and 'Help' are also visible.

NetAgent Mini & NetAgent II

The screenshot displays the 'Remote Control' interface for NetAgent Mini & NetAgent II. The top left shows the 'NetAgent' logo and the top right shows 'Remote Control'. On the left is a navigation menu with categories: Information (System Status, Basic Information, Current Status, Remote Control, Meter/Chart, Modem Status, NetFeeler II), Configuration, Log Information, and Help. The main content area contains two sections: 'UPS Testing' and 'Miscellaneous'. The 'UPS Testing' section has radio buttons for '10-Second Test' (selected), 'Deep Battery Test for 10 minute(s)', 'Test until battery capacity below 10 %', 'Test Until Battery Low', and 'Cancel Test'. The 'Miscellaneous' section has radio buttons for 'Turn off UPS when AC power Fails', 'Put UPS in Sleep mode for 60 minute(s)', 'Wake up UPS', 'Reboot UPS', and 'UPS Buzzer On/Off'. At the bottom, a 'Select and Apply' callout box with a yellow arrow points to the 'Apply' button, which is highlighted with a yellow border. Other buttons 'Reset' and 'Help' are also visible.

■ **Information > Meter/Chart**

This is to show UPS Input, Output, Temperature, Frequency..etc in graphic or chart. Java is required.



NetAgent 9 Mini & NetAgent 9

	Time-1	Value-1
Input Volt(V)	18:56:21	220.1
Output Volt(V)	18:56:21	220.1
Temperature...	18:56:21	30.1
Frequency(Hz)	18:56:21	50.0
Load(%)	18:56:21	30.0
Capacity(%)	18:56:21	100.0

NetAgent Mini & NetAgent II

NetAgent
Meter/Chart

Information

System Status
Basic Information
Current Status
Remote Control
Meter/Chart
Modem Status
NetFeeler II

Configuration

Log Information

Help

Single-Phase UPS Data Code Table

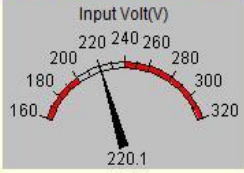
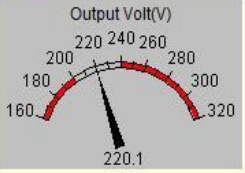
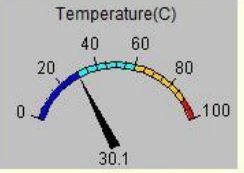
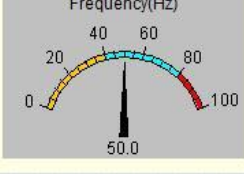
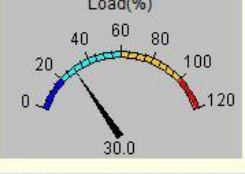
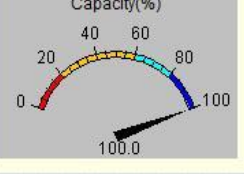
 <p>Input Volt(V) 220.1</p>	 <p>Output Volt(V) 220.1</p>	 <p>Temperature(C) 30.1</p>
 <p>Frequency(Hz) 50.0</p>	 <p>Load(%) 30.0</p>	 <p>Capacity(%) 100.0</p>

Single-Phase UPS Data Graphics

Input Volt(V)
 Output Volt(V)
 Temperature(C)

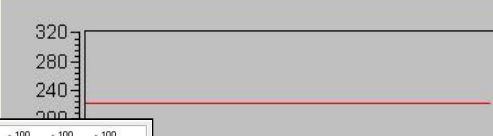

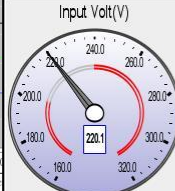

Input Volt(V)
220.1



Output Volt(V)
220.1



Temperature(C)
30.1

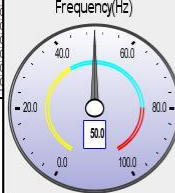

Frequency(Hz)
50.0

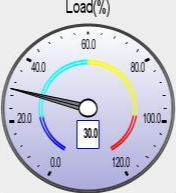

Load(%)
30.0

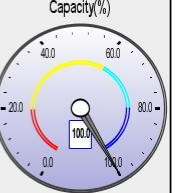

Capacity(%)
100.0

	Time-1	Value-1	T
Input Volt(V)	18:56:21	0	08.3
Output Volt(V)	18:56:21	0	08.3
Temperature	18:56:21	0	08.3
Frequency(Hz)	18:56:21	0	08.3
Load(%)	18:56:21	0	08.3
Capacity(%)	18:56:21	0	08.3

■ **Information > SMS Modem Status**

This page shows the Modem status when GPRS modem is connecting with NetAgent 9 or NetAgent II (3 Ports)

NetAgent 9

Information > SMS Modem Status

Modem Information	
Modem Manufacturer	SIEMENS
Modem Model	MC55
Modem Firmware Version	REVISION 04.00

GSM Modem Current Status	
Service Provider	TWN GSM 1800
Central number of SMS service	886935874443
Signal Strength	54%
SIM card PIN is correct or not	SIM card PIN correct or no PIN configured

[Help](#)

NetAgent II 3 Ports

NetAgent Modem Status

Modem Information	
Modem Manufacturer	SIEMENS
Modem Model	MC55
Modem Firmware Version	REVISION 04.00

GSM Modem Current Status	
Service Provider	TWN GSM 1800
Central number of SMS service	886935874443
Signal Strength	38%
SIM card PIN is correct or not	SIM card PIN correct or no PIN configured

[Help](#)

■ **Information > NetSwitch Status**

If NetAgent connects with our NetSwitch to control outlet remotely, this page shows the status of each outlet and each outlet can be turn On/Off manually

NetAgent 9

Select NetSwitch ID

Control Outlet

NetAgent II 3 Ports

■ **Information > NetFeeler (NetFeeler II)**

This page shows the environmental status when NetFeeler/ NetFeeler II and its accessories are connected with NetAent.

NetAgent 9 3PORTS

The screenshot shows the NetAgent 9 3PORTS interface. On the left is a navigation menu with categories: Information (System Status, Basic Information, Current Status, Remote Control, Meter/Chart, SMS Modem Status, NetSwitch Status, NetFeeler), Configuration, Log Information, and Help. The main content area is titled 'Information > NetFeeler' and displays the 'NetFeeler Status' table. Below the table are 'Reset Alarm' and 'Help' buttons, and a 'Refresh status every' dropdown menu set to 5 seconds.

NetFeeler Status			
Environmental Temperature	29.1 °C (84.3 °F)	Security1 Status	Normal
Environmental Humidity	54 %	Security2 Status	Normal
Water Status	Alarm	Security3 Status	Normal
Gas Status	Normal	Security4 Status	Normal
Smoke Status	Normal	Security5 Status	Normal
		Security6 Status	Normal
		Security7 Status	Normal

NetAgent II 3 Ports

The screenshot shows the NetAgent II 3 Ports interface. The top header includes 'NetAgent' on the left and 'NetFeeler II' on the right. The left navigation menu includes: Information (System Status, Basic Information, Current Status, Remote Control, Meter/Chart, Modem Status, NetFeeler II), Configuration, Log Information, and Help. The main content area is titled 'NetFeeler II' and displays the 'NetFeeler II Status' table. Above the table is a 'Refresh status every' dropdown menu set to 10 seconds. Below the table are 'Reset Alarm' and 'Help' buttons.

NetFeeler II Status	
Environmental Temperature	27.3 °C (81.1 °F)
Environmental Humidity	58 %
Water Status	Alarm
Gas Status	Normal
Smoke Status	Normal
Security1 Status	Normal
Security2 Status	Normal
Security3 Status	Normal
Security4 Status	Normal
Security5 Status	Normal
Security6 Status	Normal
Security7 Status	Normal

■ **Configuration > UPS Configuration**

- UPS Properties (Please refer to your UPS specification)

UPS Communication Type:

In order to let NetAgent and UPS to establish the communication, select the compatible protocol which your UPS supported from the list. Wrong protocol selected would cause no communication at all. (Megatec is default protocol)

Number of Batteries :

Enter the number of battery that the UPS has.

Battery Full Charge Voltage (V) :

Enter the number of the full charged voltage per battery cell. (2.267 is default, this is recommended not to be change)

Battery Exhausted Charge Voltage(V) :

Enter the number of exhausted voltage per battery cell. (1.667 is default, this is recommended not to be change)

Date of Last Battery replacement(mm/dd/yyyy) :

Enter the date of last battery replacement for record

NetAgent 9 Mini & NetAgent 9

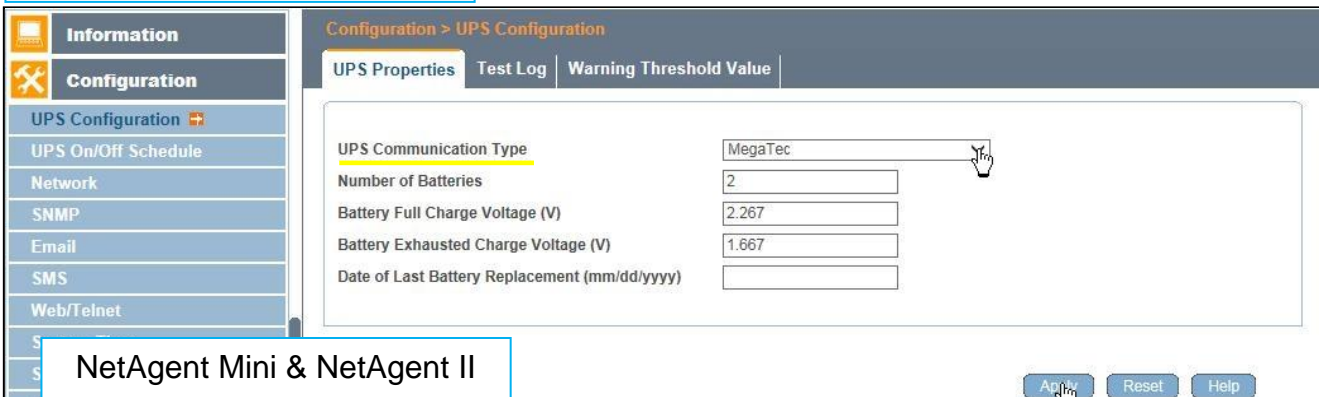

NetAgent Mini & NetAgent II

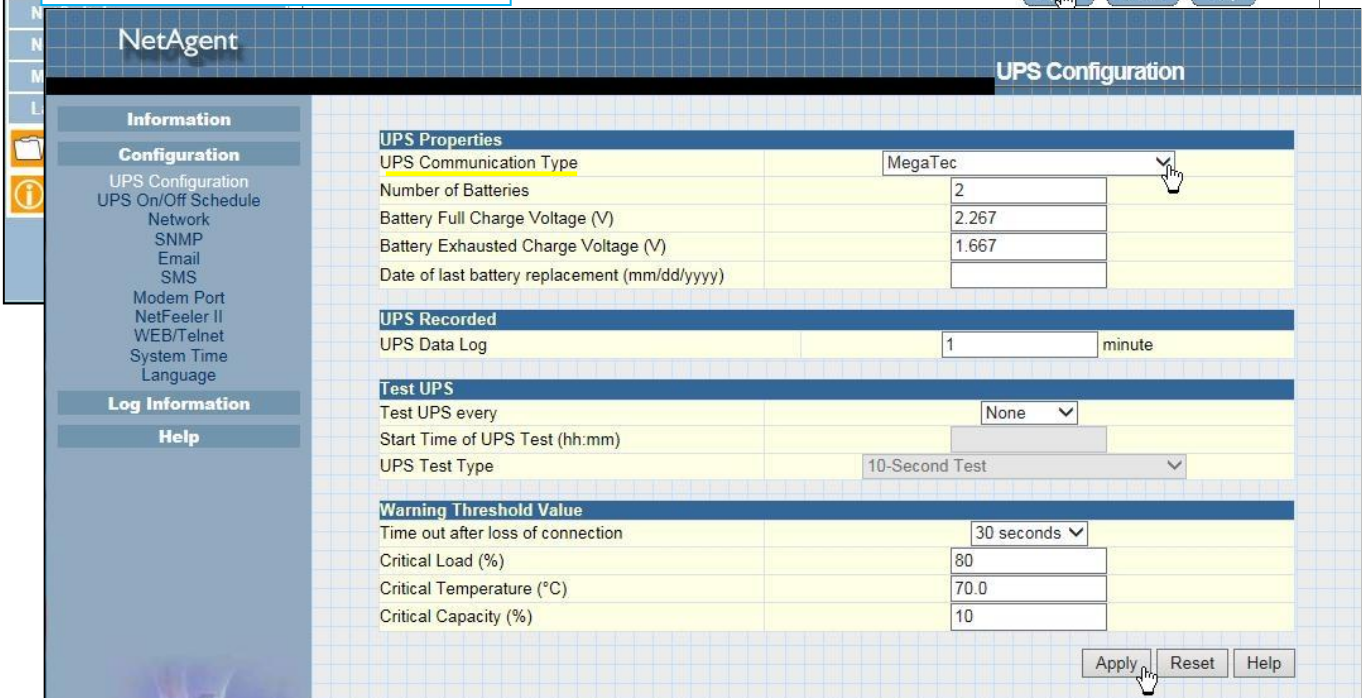

- Test Log

Test UPS Every :

Week /2 Weeks/ Month / Quarter UPS can be selected

Start Time of UPS Test (hh:mm) :

To enter the time to begin the test

UPS Test Type :

Test option can be select from the drop down list

UPS Data Log :

To enter the time interval to refreshing data

NetAgent 9 Mini & NetAgent 9

NetAgent Mini & NetAgent II

- Warning Threshold Values

Time out after loss of connection :

Send warning alarm when NetAgent and UPS lost connection at this configured time

Critical Load(%) :

When loading reaches at this % configured, NetAgent will send warning alarm

UPS Temperature (°C) :

When UPS temperature reaches at this degree configured, NetAgent will send warning alarm

Critical Capacity (%) :

When UPS battery capacity reaches at this % configured, NetAgent will send warning alarm

NetAgent 9 Mini & NetAgent 9

The screenshot shows the 'Warning Threshold Value' configuration page for NetAgent 9 Mini & NetAgent 9. The page is titled 'Configuration > UPS Configuration' and has three tabs: 'UPS Properties', 'Test Log', and 'Warning Threshold Value'. The 'Warning Threshold Value' tab is active, displaying the following settings:

Time out after loss of connection	30 seconds
Critical Load (%)	80
Critical Temperature (°C)	70.0
Critical Capacity (%)	10

At the bottom right of the configuration area, there are three buttons: 'Apply', 'Reset', and 'Help'. A mouse cursor is pointing at the 'Apply' button.

NetAgent Mini & NetAgent II

The screenshot shows the 'UPS Configuration' page for NetAgent Mini & NetAgent II. The page is titled 'NetAgent' and 'UPS Configuration'. The left sidebar contains a navigation menu with the following items:

- Information
- Configuration
 - UPS Configuration
 - UPS On/Off Schedule
 - Network
 - SNMP
 - Email
 - SMS
 - Modem Port
 - NetFeeler II
 - WEB/Telnet
 - System Time
 - Language
- Log Information
- Help

The main content area is divided into several sections:

- UPS Properties:**
 - UPS Communication Type: MegaTec
 - Number of Batteries: 2
 - Battery Full Charge Voltage (V): 2.267
 - Battery Exhausted Charge Voltage (V): 1.667
 - Date of last battery replacement (mm/dd/yyyy):
- UPS Recorded:**
 - UPS Data Log: 1 minute
- Test UPS:**
 - Test UPS every: None
 - Start Time of UPS Test (hh:mm):
 - UPS Test Type: 10-Second Test
- Warning Threshold Value (highlighted in yellow):**
 - Time out after loss of connection: 30 seconds
 - Critical Load (%): 80
 - Critical Temperature (°C): 70.0
 - Critical Capacity (%): 10

At the bottom right of the configuration area, there are three buttons: 'Apply', 'Reset', and 'Help'. A mouse cursor is pointing at the 'Apply' button.

■ Configuration > UPS On/Off Schedule

● UPS Action

When selected event happens at configured time range, UPS will be shut down

NetAgent 9 Mini & NetAgent 9

1. Time Range 2. Event 3. Time to turn off UPS 4. Add new event

Configuration > UPS On/Off Schedule

UPS Action Weekly Schedule Date Schedule Wake On Lan

During 00:00 - 23:59 if UPS Load Overrun occur, then turn off UPS after 0 minutes. Add

No.	During Time Interval(HH:MM)	Event	Delay Time (Min)	
1	00:00 - 23:59	UPS Load Overrun	10	[Delete]
2	00:00 - 23:59	AC Power Failed	8	[Delete]
3	00:00 - 23:59	UPS Battery Low	15	[Delete]
4	00:00 - 23:59	UPS Temperature Overrun	3	[Delete]

Event schedule list

Apply Reset Help

NetAgent Mini & NetAgent II

NetAgent

UPS On/Off Schedule

UPS Action

During 00:00 - 23:59 if UPS Load Overrun occur, then turn off UPS after 0 minutes. Add

No.	During Time Interval(HH:MM)	Event	Delay Time (Min)	
1	00:00 - 23:59	UPS Load Overrun	10	[Delete]
2	00:00 - 23:59	AC Power Failed	8	[Delete]
3	00:00 - 23:59	UPS Battery Low	15	[Delete]
4	00:00 - 23:59	UPS Temperature Overrun	3	[Delete]

Event schedule list

Apply Reset Help

- Weekly Schedule

This section is to set the time to turn on/off the UPS each day in the week.

NetAgent 9 Mini & NetAgent 9

Configuration > UPS On/Off Schedule

UPS Action | **Weekly Schedule** | Date Schedule | Wake On Lan

	Turn On (hh:mm)	Turn Off (hh:mm)
Sunday	05:00	23:59
Monday	00:00	23:59
Tuesday	00:00	23:59
Wednesday	00:00	23:59
Thursday	00:00	23:59
Friday	00:00	23:59
Saturday	00:00	23:59

Warning will be initiated before Scheduled Shutdown Event

Apply Reset Help

NetAgent Mini & NetAgent II

NetAgent

UPS On/Off Schedule

Weekly Schedule

	Turn On (hh:mm)	Turn Off (hh:mm)
Sunday	05:00	23:59
Monday	00:00	23:59
Tuesday	00:00	23:59
Wednesday	00:00	23:59
Thursday	00:00	23:59
Friday	00:00	23:59
Saturday	00:00	23:59

Date Schedule

Date (yyyy/mm/dd)	Turn On (hh:mm)	Turn Off (hh:mm)

Warning will be initiated before Scheduled Shutdown Event

Apply Reset Help

- Date Schedule

This section is to set the time to turn on/off the UPS on particular days. (e.g, holidays.) The settings here override the settings in **Weekly Schedule**.

Warning will be initiated before Schedule shutdown event

NetAgent will send a warning message before a scheduled shutdown. This section sets the delay time period after the message is sent and before the scheduled shutdown is started.

NetAgent 9 Mini & NetAgent 9

The screenshot shows the configuration page for 'Date Schedule' in NetAgent 9. The left sidebar contains navigation menus for Information, Configuration, Log Information, and Help. The main content area is titled 'Configuration > UPS On/Off Schedule' and has tabs for 'UPS Action', 'Weekly Schedule', 'Date Schedule', and 'Wake On Lan'. The 'Date Schedule' tab is active, displaying a table with columns for 'Date (yyyy/mm/dd)', 'Turn On (hh:mm)', and 'Turn Off (hh:mm)'. Below the table, there is a dropdown menu for 'Warning will be initiated' set to '10 minutes' before the 'Scheduled Shutdown Event'. At the bottom right, there are 'Apply', 'Reset', and 'Help' buttons.

Date (yyyy/mm/dd)	Turn On (hh:mm)	Turn Off (hh:mm)
2017/05/06	05:00	23:00
2017/08/08	08:00	23:59
2017/09/12	09:00	17:00
2017/10/20	19:00	23:59
2017/10/22	04:00	18:00
2017/11/01	00:00	06:00
2017/12/31	00:00	07:00

Warning will be initiated before Scheduled Shutdown Event

Apply Reset Help

NetAgent Mini & NetAgent II

The screenshot shows the configuration page for 'Date Schedule' in NetAgent Mini & NetAgent II. The left sidebar contains navigation menus for Information, Configuration, Log Information, and Help. The main content area is titled 'NetAgent UPS On/Off Schedule' and has a 'Date Schedule' tab. The 'Date Schedule' tab is active, displaying a table with columns for 'Date (yyyy/mm/dd)', 'Turn On (hh:mm)', and 'Turn Off (hh:mm)'. Below the table, there is a dropdown menu for 'Warning will be initiated' set to '10 minutes' before the 'Scheduled Shutdown Event'. At the bottom right, there are 'Apply', 'Reset', and 'Help' buttons.

Date (yyyy/mm/dd)	Turn On (hh:mm)	Turn Off (hh:mm)
2017/05/06	05:00	23:00
2017/08/08	08:00	23:59
2017/09/12	09:00	17:00
2017/10/20	19:00	23:59
2017/10/22	04:00	18:00
2017/11/01	00:00	06:00
2017/12/31	00:00	07:00

Warning will be initiated before Scheduled Shutdown Event

Apply Reset Help

- Wake On Lan

This section is to wake the PC within the network when AC recovery, or, when battery capacity reaches at configured %. (Make sure the PC has such function supported and configure as "Enabled" under BIOS.) Enter the IP address of that PC and system would search its IP accordingly.

NetAgent 9 Mini & NetAgent 9

1. IP Address of the PC

3. MAC address will be automatically searched

4. 【Test】

2. Click 【Apply.】

Condition to wake UPS

Host	IP	MAC	Test
Host1	192.168.1.5	00:18:F3:91:A3:C4	Test
Host2	192.168.1.4	00:03:EA:08:2D:EF	Test
Host3	IP:	MAC:	Test
Host4	IP:	MAC:	Test
Host5	IP:	MAC:	Test
Host6	IP:	MAC:	Test
Host7	IP:	MAC:	Test
Host8	IP:	MAC:	Test

Miscellaneous

Wake up remote host after power restore

Wait until battery capacity reaches to 30 %

Apply. Reset Help

NetAgent Mini & NetAgent II

NetAgent

UPS On/Off Schedule

Warning will be initiated 10 minutes before Scheduled Shutdown Event

Wake On Lan

Miscellaneous

Date (yyyy/mm/dd)	Turn On (hh:mm)	Turn Off (hh:mm)
2017/05/06	05:00	23:00
2017/08/08	08:00	23:59
2017/09/12	09:00	17:00
2017/10/20	19:00	23:59
2017/10/22	04:00	18:00
2017/11/01	00:00	06:00
2017/12/31	00:00	07:00

Warning will be initiated 10 minutes before Scheduled Shutdown Event

Host	IP	MAC	Test
Host1	192.168.1.5	00:18:F3:91:A3:C4	Test
Host2	192.168.1.3	00:03:EA:14:B3:09	Test
Host3	IP:	MAC:	Test
Host4	IP:	MAC:	Test
Host5	IP:	MAC:	Test
Host6	IP:	MAC:	Test
Host7	IP:	MAC:	Test
Host8	IP:	MAC:	Test

Miscellaneous

Wake up remote host after power restore

Wait until battery capacity reaches to 30 %

Apply. Reset Help

■ Configuration > Network

This page is to set NetAgent Network settings.

● IPv4

NetAgent and DNS IP address can be obtain by drop down list with option of Manually , Using DHCP, or Bootp. If the IP address and DNS has been configured on Netility, then info will automatically show here

NetAgent 9 Mini & NetAgent 9

The screenshot shows the 'Configuration > Network' page for NetAgent 9 Mini & NetAgent 9. The 'IPv4' tab is selected. The 'IP Address' section shows fields for IP Address (192.168.1.100), Subnet Mask (255.255.255.0), and Gateway (192.168.1.1). The 'Obtain an IP address' dropdown is set to 'Manually', with a yellow arrow pointing to a callout box that says 'Manually Using DHCP Using Bootp'. The 'DNS Server IP' section shows fields for Primary DNS Server IP (168.95.1.1) and Secondary DNS Server IP (8.8.8.8). The 'Obtain DNS Server IP' dropdown is set to 'Manually', with a yellow arrow pointing to a callout box that says 'Manually Automatically'. At the bottom right, there are 'Apply', 'Reset', and 'Help' buttons, with 'Apply' highlighted by a yellow box.

NetAgent Mini & NetAgent II

The screenshot shows the 'Configuration > Network' page for NetAgent Mini & NetAgent II. The 'IPv4' tab is selected. The 'IP Address' section shows fields for IP Address (192.168.1.100), Subnet Mask (255.255.255.0), and Gateway (192.168.1.1). The 'Obtain an IP address*' dropdown is set to 'Manually', with a yellow arrow pointing to a callout box that says 'Manually Using DHCP Using Bootp'. The 'DNS Server IP' section shows fields for Primary DNS Server IP (192.168.1.100) and Secondary DNS Server IP (8.8.8.8). Below this, the 'Ethernet' section shows 'Connection Type*' set to 'Auto Sense' and 'Stop UPS communication when Ethernet disconnected' set to 'No'. A yellow box highlights the IP Address and DNS Server IP sections.

- IPv6

All NetAgent 9 series supports IPv6. IP address can be obtain from the drop down list with option of (Automatic/ Stateless DHCPV6/ DHCPV6/ Manual)

☀ Once click on Apply, NetAgent will reboot

NetAgent 9 Mini & NetAgent 9

Configuration > Network

IPv4 IPv6 Ethernet Dynamic DNS PPPoE

IP Address

IP Address [2001:b011:200b:14f4:49ad:ddeb:7f2]

IPv6 Prefix 64

Gateway [fe80::16d6:4dff:fe33:e962]

Obtain an address * Automatic

Router Discovery Autorespond Yes

Maximum Number of IPv6 Prefix 8

Multicast Address [FF1E::1] : 5000

DNS Server IP

Primary DNS Server 2001:b000:168::1

Secondary DNS Server 2001:b000:168::1

*: System will reboot when these items have been Applied.

Apply Reset Help

Information > System Status

System Information Network Status

Ethernet

MAC Address 00:03:EA:14:B3:09

Connection Type 100Mbps Full-Duplex

General

Email Server

Time Server time.nist.gov

PPPoE IP

PPPoE IPv6

IPv4

IP Address 192.168.1.100

Subnet Mask 255.255.255.0

Gateway 192.168.1.1

Primary DNS Server 168.95.1.1

Secondary DNS Server 8.8.8.8

IPv6

IP Address 2001:b011:200b:14f4:203:eaff:fe14:b309/64
2001:b011:200b:14f4:49ad:ddeb:7f2e:6b5a/64

LinkLocal Address fe80::203:eaff:fe14:b309/64

Gateway fe80::16d6:4dff:fe33:e962

Primary DNS Server

Secondary DNS Server

Help

NetAgent IX

Information > Current Status

Input Status Output Status Battery Status

AC Status Normal

Latest Events

[05:25:37] Internal diagnostic self-test passed.

[05:25:13] Internal diagnostic self-test failed.

[05:24:28] Utility power has been restored.

- Ethernet

Connection Type

This section is to set communication speed between NetAgent and Network.

☛ Once click on Apply, NetAgent will reboot

Stop UPS communication when Ethernet disconnected

This section is to set if to stop UPS communication when NetAgent disconnects with Ethernet

NetAgent 9 Mini & NetAgent 9

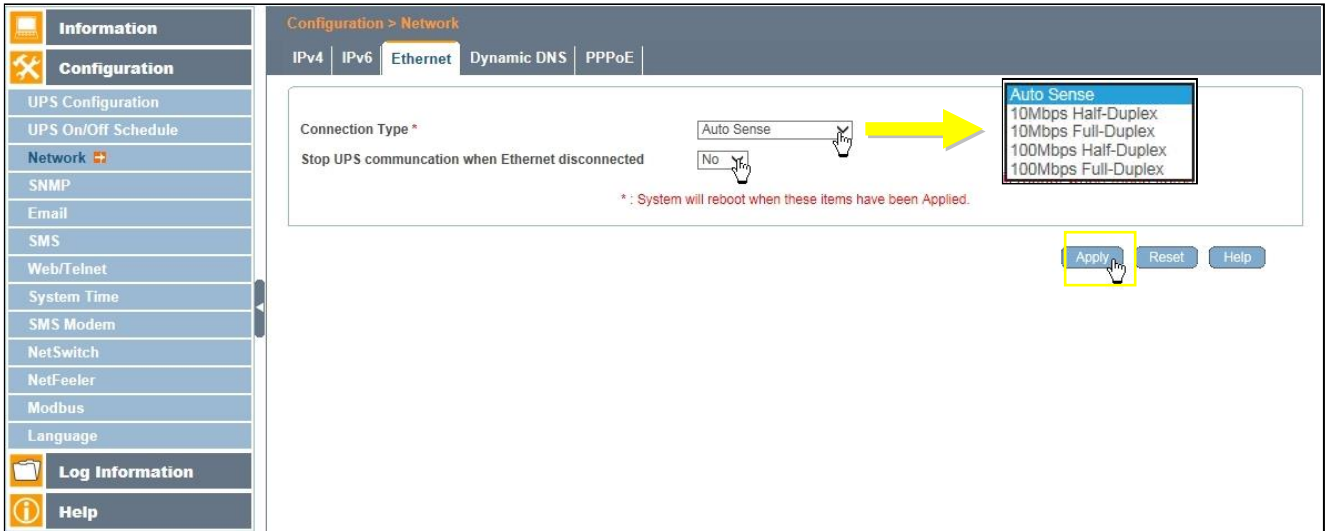

NetAgent Mini & NetAgent II

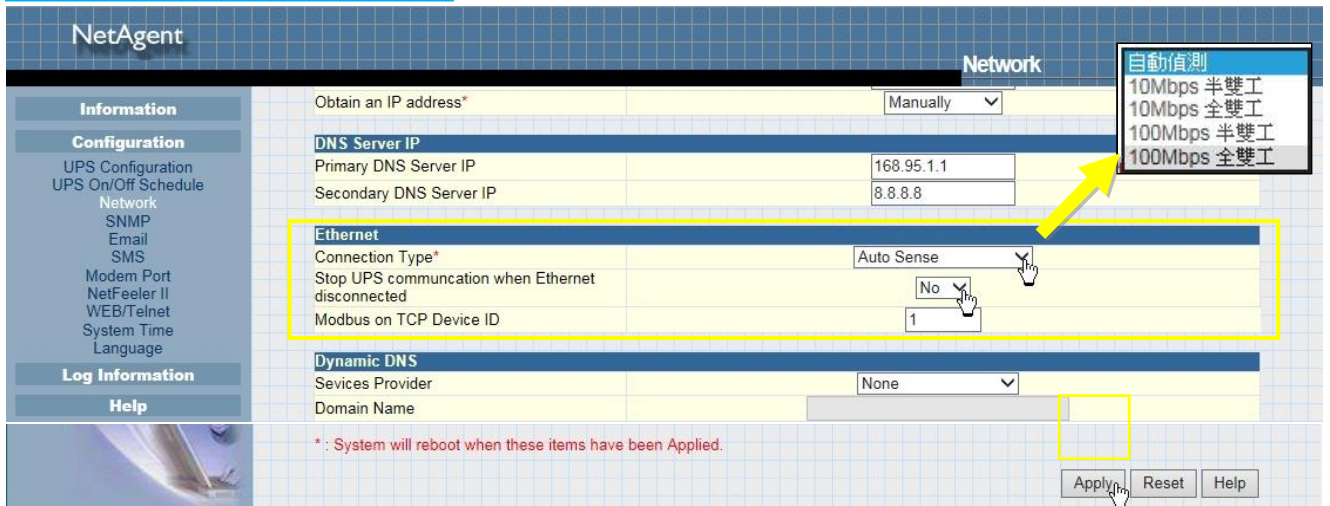

- Dynamic DNS

This is a free service that allows the user to alias a dynamic IP address to a static hostname. Ensure account/password has been registered from the DNS service provider

Service Provider

Dynamic DNS providers can be select from the list

Domain Name

This is the Domain Name you have created from the above selected DDNS provider

Login Name

This is the Login / Account name that you have created with the selected DDNS provider.

Login Password:

Enter the Password you have assigned to your DDNS Account.

Use external STUN server to get Public IP to register

Choose **Yes** to ensure that NetAgent uses the WAN / Public IP to update the selected DDNS server

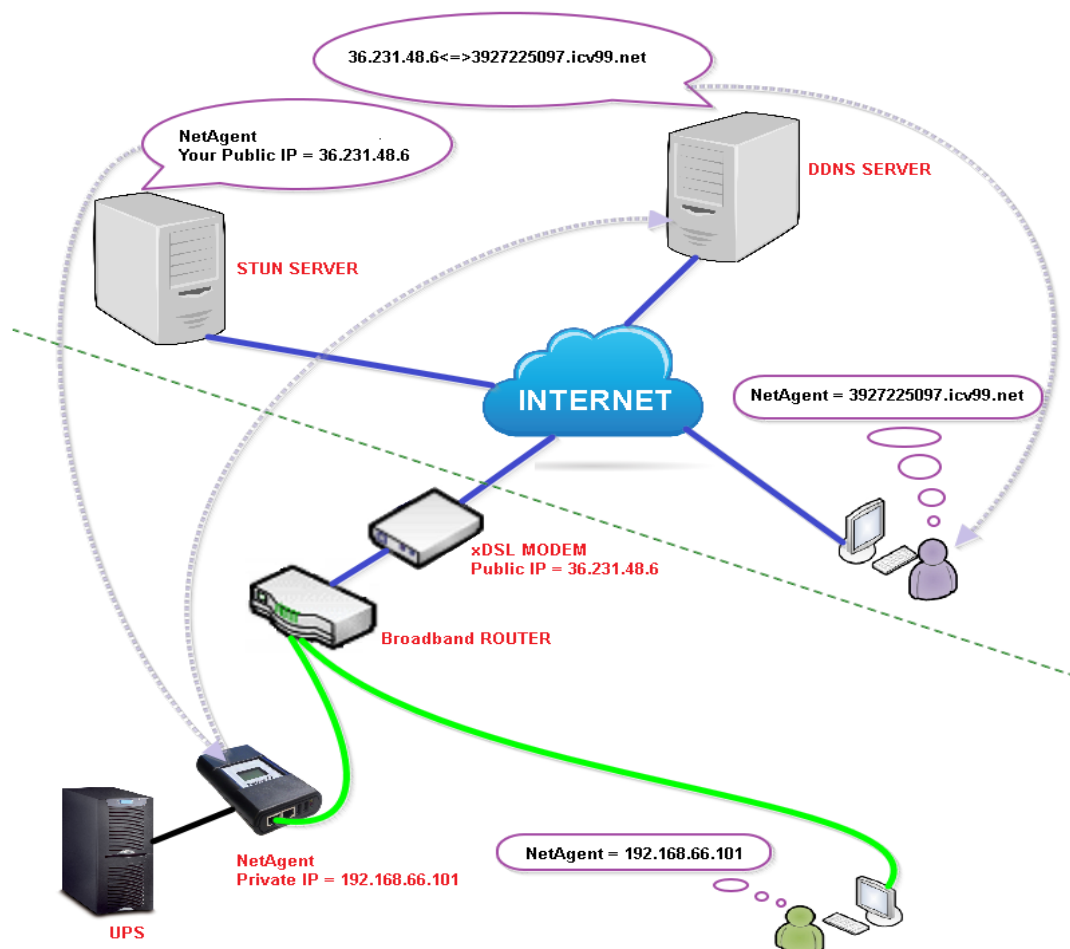

If to use icv99.net as Service Provide which host by Megatec, instruction asb elow:

1. Ensure NetAgent is able to connect to Internet. Select icv99.net from the drop down list of the Service Provider. The Domain Name and Login Name will automatically be fill-in with serial number of the device. Enter the password of the NetAgent which is printed on the NetAgent label, then click Apply.

NetAgent 9 Mini & NetAgent 9

4.Registration complete

1.Select icv99.net

2. Enter password

3. Click Apply

Service Provider: icv99.net
 Domain Name: 3927225097.icv99.net
 Login Name: 3927225097
 Login Password: [REDACTED]

Use external STUN server to get Public IP to register: No
 Primary STUN Server IP: 211.167.53
 Secondary STUN Server IP: [REDACTED]

Dynamic DNS dropdown options: None, 3322.org, dhs.org, DynDNS(Dynamic), DynDNS(Custom), myddns.com, zive.org, freedns.org, icv99.net

NetAgent 9 Label: S/N: Y-3927225097 Model: BY50E, MAC: 00-03-EA-14-B2-E0, Password: 24931D03

NetAgent Mini & NetAgent II

1.Select icv99.net

2.Enter Password

3. Click Apply

Dynamic DNS dropdown options: None, 3322.org, dhs.org, DynDNS(Dynamic), DynDNS(Custom), myddns.com, zive.org, icv99.net

Dynamic DNS fields: Services Provider: icv99.net, Domain Name: 3926404591.icv99.net, Login Name: 3926404591, Login Password: [REDACTED]

Use external STUN server to get Public IP to register: Yes
 Primary STUN Server IP: 211.21.67.53
 Secondary STUN Server IP: [REDACTED]

NetAgent II Label: S/N: T-3926404591 Model: BT506, MAC: 00-03-EA-08-2D-EF, Password: 2BB1ED12

- If using router, please login to router and direct IP and port number under virtual server for port forwarding. Kindly refer to router's manual

Router Configuration

VIRTUAL SERVER

The Virtual Server option allows you to define a single public port on your router for redirection to an internal LAN IP Address and Private LAN port if required. This feature is useful for hosting online services such as FTP or Web Servers.

Save Settings Don't Save Settings

24 -- VIRTUAL SERVERS LIST

Name	Application Name	Public Port	Protocol	Schedule
<input checked="" type="checkbox"/> BY506	<< Application Name	80	TCP	Always
IP Address	<< Computer Name	Private Port		Inbound Filter
192.168.66.101		80	6	Allow All

- After 20 minutes, NetAgent should be login with its DDNS Domain name

NetAgent 9 Mini & NetAgent 9

NetAgent IX

Information > Current Status

Input Status Output Status Battery Status

AC Status	Normal
Input Line Voltage	220.1 V
Input Max. Line Voltage	220.1 V
Input Min. Line Voltage	220.1 V
Input Frequency	50.0 Hz

NetAgent Mini & NetAgent II

Current Status

Refresh status every 10 seconds

UPS Status: UPS Normal

Input Status

AC Status	Normal
Input Line Voltage	220.1 V
Input Max. Line Voltage	220.1 V
Input Min. Line Voltage	220.1 V
Input Frequency	50.0 Hz

Output Status

Output Voltage	220.1 V
Output Status	Online
UPS load	10 %

Battery Status

Temperature	30.1 °C (86.1 °F)
Battery Status	Battery Normal
Battery Capacity	100 %
Battery Voltage	325.2 V
Time on Battery	00:00:00
Estimated Battery Remaining Time	00:00:00
UPS Last Self Test	--
UPS Next Self Test	--

4. To change domain name or password, please go to www.icv99.net

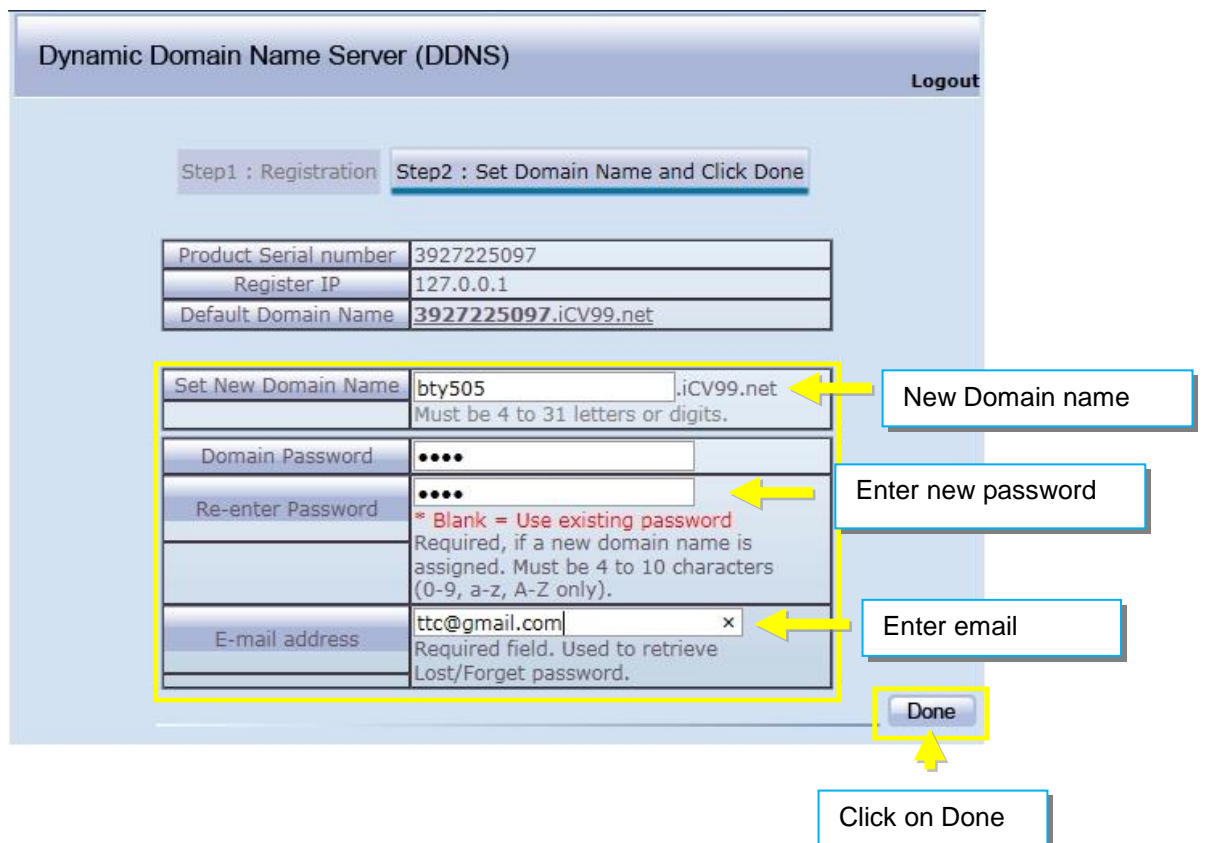

- PPPoE

Use this option to allow NetAgent to connect to the Internet directly using your xDSL modem by PPPoE. Enter the Login name and password to enable the connection. Once set-up, NetAgent will connect directly to the Internet, any abnormal connection failure would also cause to re-dial

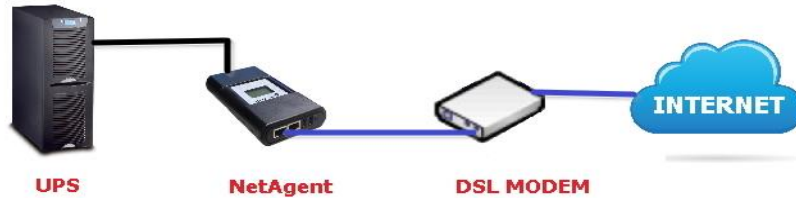

NetAgent 9 Mini & NetAgent 9

Select Connect Always

When Connection should be made: Connect always

Login Name: 87742936@hinet.net

Login Password:

Buttons: Apply, Reset, Help

Annotations: Enter Login Name, Enter Password

NetAgent Mini & NetAgent II

Network Configuration

Obtain an IP address*: Using DHCP

DNS Server IP: Primary 192.168.66.1

Ethernet: Connection Type: Auto Sense

Dynamic DNS: Services Provider: icv99.net

PPPoE: When Connection should be made: Connect always

Login Name: 87742936@hinet.net

Login Password:

Buttons: Apply, Reset, Help

Annotations: Select Connect Always, Disabled Connect always, Enter Login Name, Enter Password

■ **Configuration > Wireless**

This is to configure Wireless network with USB wireless dongle. This feature only apply to NetAgent 9 model of BX and BY series. (USB wireless dongle is optional)
 NetAgent 9 BX/BY models supports wireless encryption of Open system; Shared Key; WEP(64 /128 bit) / WPA / WPA2(TKIP/AES)

- Connect the compatible USB wireless dongle to BX/BY NetAgent



- Click on **【 Scan 】** to search for all the available AP. Select the AP, then enter its SSID, Authentication, WPA Encryption, WPA Key , then click on Apply

NetAgent 9 Mini & NetAgent 9

SSID	MAC Address	Network Security	Auth(Enc)	Signal(%)
<input type="radio"/> Megatec_Radius1	00:90:cc:f4:98:98	Secure Network	WPA(2) (AES)	
<input type="radio"/> DASAN_GONT	00:d0:cb:ef:06:22	Secure Network	WPA2-PSK (AES)	
<input checked="" type="radio"/> T1_WiFi	14:d6:4d:33:e9:62	Secure Network	WPA2-PSK (TKIP)	

SSID	<input type="text" value="T1_WiFi"/>
Authentication	<input type="text" value="WPA2-PSK"/>
WPA Encryption	<input type="text" value="TKIP"/>
WPA Key (8 to 64 characters)	<input type="text" value="....."/>

1. Scan → 2. Select AP → 3. Select Authentication → 4. Select WPA → 5. Enter WPA Key → 6. Apply

Configuration > Wireless

AP Setting | IPv4 | IPv6

SSID	MAC Address	Network Security	Auth(Enc)	Signal(%)
<input type="radio"/> Megatec_Radius1	00:90:cc:f4:98:98	Secure Network	WPA(2) (AES)	
<input type="radio"/> DASAN_GONT	00:d0:cb:ef:06:22	Secure Network	WPA2-PSK (AES)	
<input checked="" type="radio"/> T1_WiFi	14:d6:4d:33:e9:62	Secure Network(Connected)	WPA2-PSK (TKIP)	

Scan Select

7. Connected

SSID: T1_WiFi

Authentication: WPA2-PSK

WPA Encryption: TKIP

WPA Key (8 to 64 characters):

Apply Reset Help

Connection Information can be check from **【Information】 > 【System Status】 > 【Wireless Status】**

Information > System Status

System Information | Network Status | **Wireless Status**

Ethernet		General	
MAC Address	54:E6:FC:90:17:EC	Primary DNS Server	192.168.66.1
		Secondary DNS Server	

IPv4		IPv6	
IP Address	192.168.66.103	IP Address	
Subnet Mask	255.255.255.0	LinkLocal Address	fe80::56e6:fcff:fe90:17ec/64
Gateway	192.168.66.1	Gateway	

Help

■ Configuration > SNMP

This page is to set NetAgent SNMP settings so it can be used by a NMS (Network Management System). (e.g: SNMPView, it can be available on the NetAgent Utility CD.)

SNMP version supported by NetAgent type

	SNMP V1	SNMP V2	SNMP V3
NetAgent 9 & Mini	✓	✓	✓
NetAgent II & Mini	✓	✓	

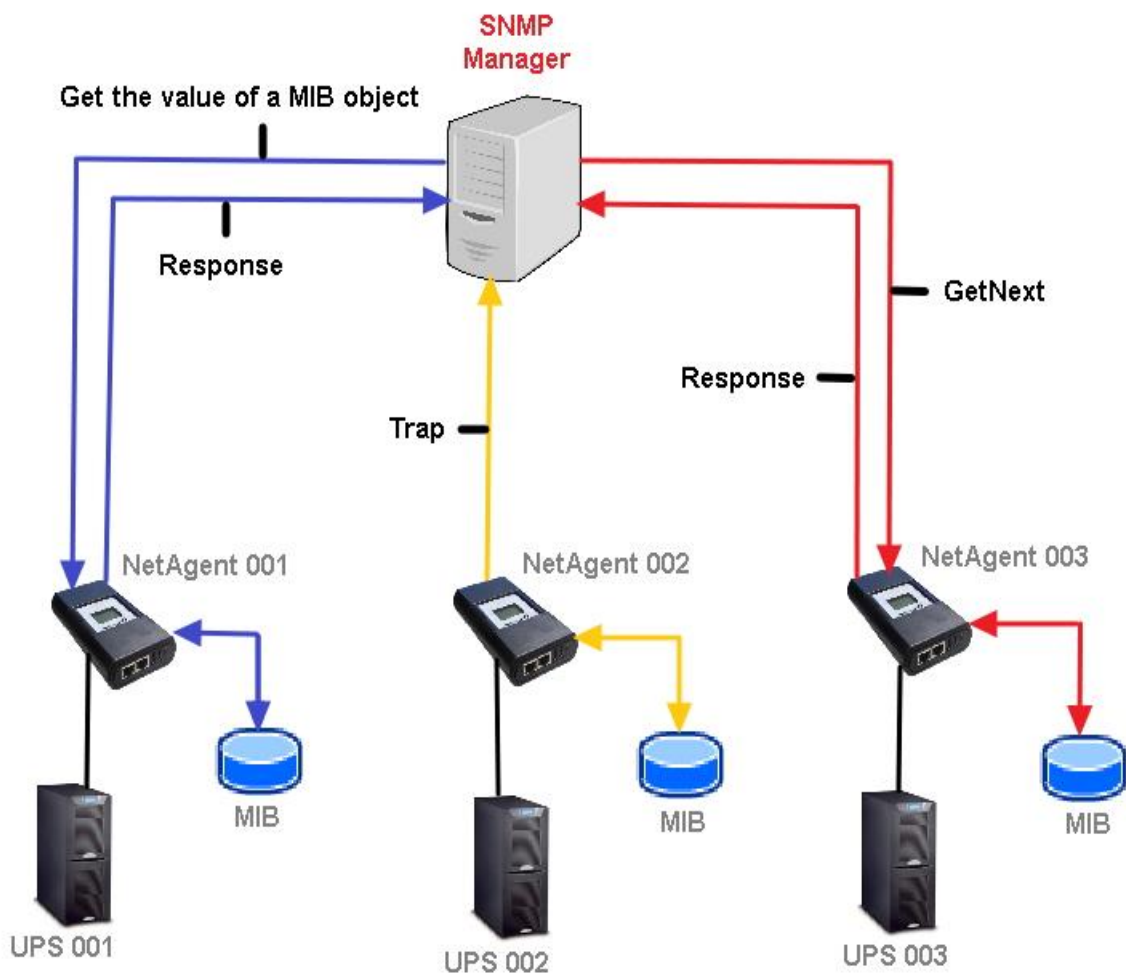

- General

MIB System

System Name

This section is to give a name to the NetAgent.

System Contact

This section is to give a name to the administrator.

System Location

This section is to set NetAgent location.

SNMP UDP Port

NetAgent SNMP Port :

The port that NetAgent receive and send SNMP command. (Default is 161)

Trap Receive Port :

The port to receive trap. (Default is 162)

SNMPv3 Engine ID

SNMPv3 Engine ID Format Type :

When using SNMPv3, NetAgent requires to have its Engine ID for identification to generates authentication and encryption key . Format type can be select from the drop down list with option of MAC Address / IPv4 / IPv6 / Manual

✳Once click on Apply, NetAgent will reboot

SNMPv3 Engine ID Text :

SNMPv3 Engine ID content

NetAgent 9 Mini & NetAgent 9

The screenshot displays the configuration page for NetAgent 9, specifically the SNMP settings. The interface is divided into a left sidebar and a main content area. The sidebar contains various configuration categories, with 'Configuration' selected. The main content area shows the 'SNMP' configuration page, which is further divided into tabs: 'General', 'Access Control', 'Trap Notification', and 'Device Connected'. The 'General' tab is active, showing the following settings:

- MIB System:**
 - System Name: UPS Agent
 - System Contact: Administrator
 - System Location: My Office
- SNMP UDP Port:**
 - NetAgent SNMP Port: 161
 - Trap Receive Port: 162
- SNMPv3 Engine ID:**
 - SNMPv3 Engine ID Format Type*: MAC Address (selected from a dropdown menu)
 - SNMPv3 Engine ID Text: 80003461030003ea14b309

At the bottom of the page, there is a red warning message: '* : System will reboot when these items have been Applied.' Below this message are three buttons: 'Apply', 'Reset', and 'Help'.

NetAgent Mini & NetAgent II

MIB System

System Name	System Contact	System Location
UPS Agent	Administrator	My Office

Access Control

Manager IP Address	Community	Permission	Description
..*.*	public	Read/Write	
..*.*	public	No Access	
..*.*	public	No Access	
..*.*	public	No Access	
..*.*	public	No Access	
..*.*	public	No Access	
..*.*	public	No Access	

SNMP UDP Port

NetAgent SNMP Port*	Trap Receive Port*
161	162

*: System will reboot when this item has been Applied.

● Access Control

Manager IP Address :

This is to set the IP address that the administrator can manage NetAgent from. It is valid for up to 8 IP addresses. To manage NetAgent from any IP address, enter *.*.*.* into **Manager IP address**.

Version:

This is to select between SNMPv1& SNMPv2 or SNMPv3 (SNMPv3 only applies to NetAgent 9 series) When select All and V3, user name, password, authentication and privacy are required

Community :

This section is to set a Community name for NMS. The community name has to be as the same as the setting in NMS. (Default is public)

Permission :

This is to set authorities of administrators. Options are Read, Read/Write, and No Access.

Description :

This is to make note for administrator's reference

NetAgent 9 Mini & NetAgent 9

SNMP Version all(v3) Settings

User Name	USER2658
Authentication Protocol	MD5
Authentication Password	*****
Privacy Protocol	DES
Privacy Password	*****

Access Control

Manager IP Address	Version	Community	Permission	Description
192.168.66.2	V1 & V2C	public	Read/Write	
192.168.66.88	V3	public	Read/Write	
192.168.66.86	V1 & V2C	public	Read/Write	
192.168.66.105	V1 & V2C	public	Read/Write	
192.168.66.128	V1 & V2C	public	Read/Write	
192.168.66.147	V1 & V2C	public	Read/Write	
192.168.66.211	V1 & V2C	public	Read/Write	6F
..*.*	All	public	Read	

..*.* means any IP

At least 8 characters

NetAgent Mini & NetAgent II

The screenshot shows the NetAgent SNMP configuration page. The 'Access Control' table is highlighted with a yellow border. The table has the following data:

Manager IP Address	Community	Permission	Description
192.168.66.2	public	Read/Write	2F
192.168.66.88	public	Read/Write	
192.168.66.86	public	Read/Write	
192.168.66.105	public	Read/Write	
192.168.66.128	public	Read/Write	6F
192.168.66.147	public	Read/Write	
192.168.66.211	public	Read/Write	
****	public	Read	

The 'Apply' button is highlighted with a yellow border.

- Trap Notification

Trap Notification

Destination IP Address :

To set receivers IP address for receiving traps sent by NetAgent. It is valid for up to 8 IP Addresses.

Accept :

Select the trap type of its SNMP version or Inform from drop down list. When SNMPv3 trap or SNMPv3 Inform is selected, username/password and authentication information are required.

Community :

Trap receiver and NetAgent must be same community. (Default is public)

Trap Type :

Select from PPC MIB or RFC1628 MIB (Default is PPC)

✳MIB file is available in the CD provided with NetAgent

Severity :

This section is to set Trap level for each receiver. There are three levels as below

- Information: To receive all traps.
- Warning: To receive only “warning” and “severe” traps.
- Severe: To receive only “severe” traps.
(Please refer to NMS manual for Trap levels.)

Description :

This is to make note for administrator’s reference

Events :

This is to select events for NetAgent to send traps. Click on Select to show the full Events List. Click on Test to send test trap to ensure all setting is correct

Send Power Restore and Adaptor Restore Traps for X time(s) in X second(s) Interval.

This is to set number of trap to send in preset second when power restore on NetAgent. This is to check if the communication between trap receiver and NetAgent remains well or not after power recovers

SNMP Inform Request

This is to set the number of times that the NetAgent can request a response from the sending Inform host with a preset value . (Default is 3 times and an interval of 5 seconds)

NetAgent 9 Mini & NetAgent 9

Configuration > SNMP

General | Access Control | **Trap Notification** | Device Connected

Destination IP	Accept	Community	Trap Type	Severity	Description	Events
192.168.66.12	SNMPv3 Trap	public	PPC	Information	8F IDC	Select Test
192.168.66.28	SNMPv1 Trap	public	PPC RFC1628	Information	8F IDC	Select Test
192.168.66.45	SNMPv2 Trap	public	PPC	Warning	7F IDC	Select Test
192.168.66.67	SNMPv2 Inform	public	PPC	Severe	8F IDC	Select Test
192.168.66.70	SNMPv2 Trap	public	PPC	Warning	9F IDC	Select Test
192.168.66.101	SNMPv2 Inform	public	PPC	Severe	10F IDC	Select Test
192.168.66.211	SNMPv4 Trap	public	PPC	Warning	11F IDC	Select Test
192.168.66.234	SNMPv3 Inform	public	PPC	Information	12F IDC	Select Test

Send Power Restore and Adapter Restore Traps for 2 time(s) in 5 second(s) interval.

SNMP Inform Request

Number of Retries: 3
Timeout (sec): 5

Apply Reset Help

SNMPv3 Trap Settings

User Name: admin1028

Authentication Protocol: MD5

Authentication Password:

Privacy Protocol: DES

Privacy Password:

None MD5 SHA

Apply Reset

Select Event

UPS Events | NetFeeler II

Schedule Shutdown Event	YES	NO
UPS Failure	<input checked="" type="radio"/>	<input type="radio"/>
UPS entering Test mode	<input checked="" type="radio"/>	<input type="radio"/>
UPS entering Sleeping mode	<input checked="" type="radio"/>	<input type="radio"/>
UPS entering Boost mode	<input checked="" type="radio"/>	<input type="radio"/>
UPS Load Overrun	<input checked="" type="radio"/>	<input type="radio"/>
UPS Communication Loss	<input checked="" type="radio"/>	<input type="radio"/>
Turn Off UPS	<input checked="" type="radio"/>	<input type="radio"/>
AC Power Failed	<input checked="" type="radio"/>	<input type="radio"/>
UPS Battery Low	<input checked="" type="radio"/>	<input type="radio"/>
UPS Temperature Overrun	<input checked="" type="radio"/>	<input type="radio"/>
UPS Capacity Underrun	<input checked="" type="radio"/>	<input type="radio"/>
UPS entering Bypass mode	<input checked="" type="radio"/>	<input type="radio"/>

Select All Clear All Apply

NetAgent Mini & NetAgent II

SNMP

192.168.66.211 public Read/Write Read

**** public

Trap Notification						
Destination IP Address	Community	Trap Type	Severity	Accept	Description	Events
192.168.66.12	public	PPC	Information	SNMPv1 Trap	5F IDC	Select Test
192.168.66.28	public	RFC1628	Warning	SNMPv2 Trap	6F IDC	Select Test
192.168.66.45	public	PPC	Severe	SNMPv2 Inform	7F IDC	Select Test
192.168.66.67	public	PPC	Information	SNMPv1 Trap	8 IDC	Select Test
192.168.66.70	public	PPC	Warning	SNMPv2 Trap	9 IDC	Select Test
192.168.66.33	public	PPC	Severe	SNMPv2 Inform	10 IDC	Select Test
192.168.66.90	public	PPC	Information	SNMPv2 Trap	11 IDC	Select Test
192.168.66.17	public	PPC	Information	SNMPv2 Inform	12 IDC	Select Test

Send Power Restore and Adapter Restore Traps for 2 time(s) in 5 second(s) interval.

SNMP Inform Request

Number of Retries: 3 Timeout (sec): 5

Device Connected

Device	Rating (%)	Connected
	0	NO
	0	NO
	0	NO
	0	NO

SNMP UDP Port

NetAgent SNMP Port* Trap Receive Port*

* : System will reboot when this item has been Applied.

Apply Reset Help

UPS Events	Yes	No
Schedule Shutdown Event	<input checked="" type="radio"/>	<input type="radio"/>
UPS Failure	<input checked="" type="radio"/>	<input type="radio"/>
UPS entering Test mode	<input checked="" type="radio"/>	<input type="radio"/>
UPS entering Sleeping mode	<input checked="" type="radio"/>	<input type="radio"/>
UPS entering Boost mode	<input checked="" type="radio"/>	<input type="radio"/>
UPS Load Overrun	<input checked="" type="radio"/>	<input type="radio"/>
UPS Communication Lost	<input checked="" type="radio"/>	<input type="radio"/>
Turn Off UPS	<input checked="" type="radio"/>	<input type="radio"/>
AC Power Failed	<input checked="" type="radio"/>	<input type="radio"/>
UPS Battery Low	<input checked="" type="radio"/>	<input type="radio"/>
UPS Temperature Overrun	<input checked="" type="radio"/>	<input type="radio"/>
UPS Capacity Underrun	<input checked="" type="radio"/>	<input type="radio"/>
UPS entering Bypass mode	<input checked="" type="radio"/>	<input type="radio"/>
NetFeeler II	Yes	No
Smoke Alarm	<input checked="" type="radio"/>	<input type="radio"/>
Water Alarm	<input checked="" type="radio"/>	<input type="radio"/>
Gas Alarm	<input checked="" type="radio"/>	<input type="radio"/>
Security Alarm	<input checked="" type="radio"/>	<input type="radio"/>
Environmental Temperature Overrun	<input checked="" type="radio"/>	<input type="radio"/>
Environmental Temperature Underrun	<input checked="" type="radio"/>	<input type="radio"/>
Environmental Humidity Overrun	<input checked="" type="radio"/>	<input type="radio"/>
Environmental Humidity Underrun	<input checked="" type="radio"/>	<input type="radio"/>

Select All Clear All Apply

- Device Connected

This section is to set the usage power and connection status of other devices which connects to the same UPS as NetAgent uses.

NetAgent 9 Mini & NetAgent 9

The screenshot shows the 'Configuration > SNMP' page with the 'Device Connected' tab selected. A table lists four devices with their respective power ratings and connection status.

	Device	Rating (%)	Connected
1	EPSON PRINTER	25	YES
2	ACER LCD	15	YES
3	ASUS i5 PC	20	YES
4	HP i5 PC	20	YES

Buttons: Apply, Reset, Help

NetAgent Mini & NetAgent II

The screenshot shows the 'SNMP' configuration page. It includes a table of SNMP traps, a 'Device Connected' table, and 'SNMP Inform Request' settings.

Destination IP Address	Community	Trap Type	Severity	Trap Type	Description	Event
192.168.66.12	public	PPC	Information	SNMPv1 Trap	5F IDC	Select Test
192.168.66.28	public	RFC1628	Warning	SNMPv2 Trap	6F IDC	Select Test
192.168.66.45	public	PPC	Severe	SNMPv2 Inform	7F IDC	Select Test
192.168.66.67	public	PPC	Information	SNMPv1 Trap	8 IDC	Select Test
192.168.66.70	public	PPC	Warning	SNMPv2 Trap	9 IDC	Select Test
192.168.66.33	public	PPC	Severe	SNMPv2 Inform	10 IDC	Select Test
192.168.66.90	public	PPC	Information	SNMPv2 Trap	11 IDC	Select Test
192.168.66.17	public	PPC	Information	SNMPv2 Inform	12 IDC	Select Test

Send Power Restore and Adapter Restore Traps for 2 time(s) in 5 second(s) interval.

SNMP Inform Request

Number of Retries	Timeout (sec)
3	5

Device Connected

Device	Rating (%)	Connected
EPSON PRINTER	25	YES
ACER LCD	15	YES
ASUS i5 PC	20	YES
HP i5 PC	20	YES

SNMP UDP Port

NetAgent SNMP Port*	Trap Receive Port*
161	162

* : System will reboot when this item has been Applied.

Buttons: Apply, Reset, Help

■ **Configuration > Email**

To send email notification when event occurs or data log

● **Email Setting**

Email Server:

Enter the address of email server

Email Port:

Email Port that use for sending email

Enable SSL on Email Transmission:

Select SSL type for email transmission

Type of encryption that NetAgent model supports

	SSL	TLS	STARTTLS
NetAgent 9 & Mini	✓	✓	✓
NetAgent II DT/CT/BT	✓		

Sender's Email Address :

To enter the email address that for sending email

Email Server Requires Authentication :

If such email server requires authentication or not

Account name :

If authentication is required, enter its account name

Password :

If authentication is required, enter its password

Sending Test Mail :

Enter email address to check all configuration is correct or not to receiving mail

NetAgent 9 Mini & NetAgent 9

Configuration > Email

Email Setting | Email for Event Log | Email for Daily Report

Email Server: smtp.gmail.com

Email Port: 465

Enable SSL on Email Transmission: SSL/TLS

Sender's Email Address: ttc@gmail.com

Email Server Requires Authentication: YES

Account Name: ttc

Password: [REDACTED]

Sending test mail: [REDACTED]

Apply | Reset | Help

Configuration > Email

Email Setting | Email for Event Log | Email for Daily Report

Email Server: smtp.gmail.com

Email Port: 465

Enable SSL on Email Transmission: SSL/TLS

Sender's Email Address: ttc@gmail.com

Email Server Requires Authentication: YES

Account Name: ttc

Password: [REDACTED]

Sending test mail: ttc2@gmail.com

Apply | Reset | Help

NetAgent IX

Latest Events

[08:19:06] Mail has been sent

Configuration > Email

Email Setting | Email for Event Log | Email for Daily Report

Email Server: smtp.gmail.com

Email Port: 465

Enable SSL on Email Transmission: SSL/TLS

Sender's Email Address: ttc@gmail.com

Email Server Requires Authentication: YES

Account Name: ttc

Password: [REDACTED]

Sending test mail: [REDACTED]

Apply | Reset | Help

Test Email Received

UPS Agent(192.168.66.106): This is a test email

ttc@gmail.com <ttc@gmail.com>

寄給我

If you received this test mail, it means that your mail settings are correct.

NetAgent Mini & NetAgent II

1. Enter Mail Server

The screenshot shows the NetAgent configuration interface for email settings. A yellow box highlights the 'Email Setting' section. Annotations include: '1. Enter Mail Server' pointing to the 'Email Server' field (msa.hinet.net); '3. Test Mail' pointing to the 'Test Mail' button; and '2. Click on Apply' pointing to the 'Apply' button at the bottom right. The 'Enable SSL on Email Transmission' dropdown is set to 'None' and is also highlighted with a callout box.

Email Setting	
Email Server	msa.hinet.net
Email Port	25
Enable SSL on Email Transmission	None
Sender's Email Address	ttc@msa.hinet.net
Email Server Requires Authentication	YES
Account Name	ttc
Password	*****
Recipient's Email Address	ttc2@gmail.com

Buttons: Apply, Reset, Help

Test Email Received



- Email for Event Log (To receive email notification)

To set email addresses to receive warning email sent by NetAgent when selected event occurs. It is valid for up to 8 Email addresses.

NetAgent 9 Mini & NetAgent 9

Configuration > Email

Email Setting | **Email for Event Log** | Email for Daily Report

Send Email When Event Occurs: YES

Account1	afra@gmail.com.tw	Select
Account2	dawn@yahoo.com.tw	Select
Account3	eli@zoho.com	Select
Account4	hugo@gmail.com	Select
Account5	toby@gmail.com	Select
Account6	novia@supa.com	Select
Account7	ira@gmail.com	Select
Account8	elma.lee@msa.hinet.net	Select

Buttons: Apply, Reset, Help

Select Event (UPS Events)

Event	YES	NO
Schedule Shutdown Event	<input checked="" type="radio"/>	<input type="radio"/>
UPS Failure	<input checked="" type="radio"/>	<input type="radio"/>
UPS entering Test mode	<input checked="" type="radio"/>	<input type="radio"/>
UPS entering Sleeping mode	<input checked="" type="radio"/>	<input type="radio"/>
UPS entering Boost mode	<input checked="" type="radio"/>	<input type="radio"/>
UPS Load Overrun	<input checked="" type="radio"/>	<input type="radio"/>
UPS Communication Lost	<input checked="" type="radio"/>	<input type="radio"/>
Turn Off UPS	<input checked="" type="radio"/>	<input type="radio"/>
AC Power Failed	<input checked="" type="radio"/>	<input type="radio"/>
UPS Battery Low	<input checked="" type="radio"/>	<input type="radio"/>
UPS Temperature Overrun	<input checked="" type="radio"/>	<input type="radio"/>
UPS Capacity Underrun	<input checked="" type="radio"/>	<input type="radio"/>
UPS entering Bypass mode	<input checked="" type="radio"/>	<input type="radio"/>

Buttons: Select All, Clear All, Apply

Select Event (NetFeeler II)

Event	Yes	No
Smoke Alarm	<input checked="" type="radio"/>	<input type="radio"/>
Water Alarm	<input checked="" type="radio"/>	<input type="radio"/>
Gas Alarm	<input checked="" type="radio"/>	<input type="radio"/>
Security Alarm	<input checked="" type="radio"/>	<input type="radio"/>
Environmental Temperature Overrun	<input checked="" type="radio"/>	<input type="radio"/>
Environmental Temperature Underrun	<input checked="" type="radio"/>	<input type="radio"/>
Environmental Humidity Overrun	<input checked="" type="radio"/>	<input type="radio"/>
Environmental Humidity Underrun	<input checked="" type="radio"/>	<input type="radio"/>

Buttons: Select All, Clear All, Apply

NetAgent Mini & NetAgent II

NetAgent

Sender's Email Address: tt@msa.hinet.net

Email Server Requires Authentication: YES

Account Name: ttc

Password: *****

Recipient's Email Address: [] Test Mail

Recipient's Email Address (for Event Log)

Account	Email Address	Events
Account1	afra@gmail.com.tw	Select
Account2	dawn@yahoo.com.tw	Select
Account3	eli@zoho.com	Select
Account4	hugo@gmail.com	Select
Account5	toby@gmail.com	Select
Account6	novia@supa.com	Select
Account7	ira@gmail.com	Select
Account8	elma.lee@msa.hinet.net	Select

Buttons: 套用, 清除, 幫助

- Email for Daily Report (To receive daily report)

This section is to set Email Addresses to receive NetAgent's Daily Report at preset time. It is valid for up to 4 Email addresses. Daily report with content of event and data log.

With NetAgent series, option is available if to send email when event or data log overflows to 500 logs

NetAgent 9 Mini & NetAgent 9

The screenshot shows the 'Configuration > Email' page with the 'Email for Daily Report' tab selected. The left sidebar contains navigation options: Information, Configuration (with sub-items: UPS Configuration, UPS On/Off Schedule, Network, SNMP, Email, SMS, Web/Telnet, System Time, SMS Modem, NetSwitch, NetFeeler, Modbus, Language), Log Information, and Help.

The main configuration area includes the following fields:

- Account1:
- Account2:
- Account3:
- Account4:
- Send Email for Daily Report (hh:mm): YES at 23:59

Buttons for 'Apply', 'Reset', and 'Help' are located at the bottom right of the configuration area.

NetAgent Mini & NetAgent II

The screenshot shows the 'NetAgent' configuration page for 'Email'. The left sidebar contains navigation options: Information, Configuration (with sub-items: UPS Configuration, UPS On/Off Schedule, Network, SNMP, Email, SMS, Modem Port, NetFeeler II, WEB/Telnet, System Time, Language), Log Information, and Help.

The main configuration area includes the following fields and tables:

- Sender's Email Address:
- Email Server Requires Authentication: YES
- Account Name:
- Password:
- Recipient's Email Address:
- Test Mail button
- Recipient's Email Address (for Event Log) table:

Account	Address	Events
Account1	<input type="text" value="afra@gmail.com.tw"/>	Select
Account2	<input type="text" value="dawn@yahoo.com.tw"/>	Select
Account3	<input type="text" value="eli@zoho.com"/>	Select
Account4	<input type="text" value="hugo@gmail.com"/>	Select
Account5	<input type="text" value="toby@gmail.com"/>	Select
Account6	<input type="text" value="novia@supa.com"/>	Select
Account7	<input type="text" value="ira@gmail.com"/>	Select
Account8	<input type="text" value="elma.lee@msa.hinet.net"/>	Select
- Send Email When Event Occurs: YES
- Recipient's Email Address (for Daily Report) table:

Account1	<input type="text" value="afra@gmail.com.tw"/>
Account2	<input type="text" value="dawn@yahoo.com.tw"/>
Account3	<input type="text" value="novia@supa.com"/>
Account4	<input type="text" value="elma.lee@msa.hinet.net"/>
- Send Email for Daily Report (hh:mm): YES at 23:59
- Send Email when Event Log overflows (500 records): YES
- Send Email when Data Log overflows (500 records): YES

Buttons for 'Apply', 'Reset', and 'Help' are located at the bottom right of the configuration area.

■ Configuration > SMS

When UPS events occurs, it allows Short Message Signals (“SMS”) to be sent and received using a GSM/GPRS/CDMA Modem. Operation information are as below for single and three ports of NetAgent.

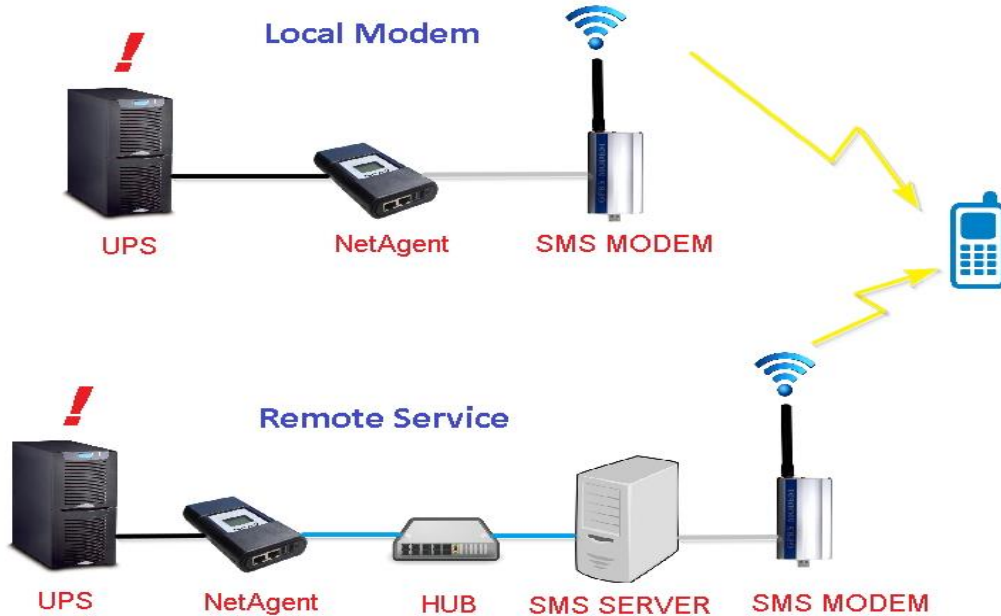

● SMS Setting :

Send SMS When Event Occurs:

- Disable : No SMS Service
- Use Local Modem : When GSM modem is connected to NetAgent directly
(Refer to SMS Modem section for its installation)
- Use Remote Service : When GSM modem connects to PC with SMS Server software installed
(Refer to SMS Server section for SMS Server Software installation)

SMS Server :

If select to use Remote Service to send SMS, then enter the IP address of the SMS Server. (The PC that installed SMS Server Software)

SMS Port :

If select to use Remote Service to send SMS, enter the port number that SMS Server uses for sending SMS. (Port 80 is default)

Account Name :

If select to use Remote Service to send SMS, enter SMS Server’s account name if required

Password :

If select to use Remote Service to send SMS, enter SMS Server’s password if required

Sending test SMS :

When modem and configuration are ready, enter a mobile number to receive testing SMS

NetAgent 9 Mini & NetAgent 9

Local Modem

Configuration > SMS

SMS Setting Mobile for Event Log

Disable Use Local Modem Use Remote Service

Send SMS When Event Occurs Use Local Modem

SMS Server

SMS Port 80

Account Name

Password

Sending test SMS 0955956637 Test SMS

1. Select Local Modem

2. Click Apply

3. Enter Mobile Number

4. Send Test SMS

Apply Reset Help

Remote Service

Configuration > SMS

SMS Setting Mobile for Event Log

Disable Use Local Modem Use Remote Service

Send SMS When Event Occurs Use Remote Service

SMS Server 192.168.66.101

SMS Port 80

Account Name ttc

Password

Sending test SMS 0955956637 Test SMS

1. Select Remote Service

2. Click Apply

3. Enter Mobile Number

4. Send Test SMS

Apply Reset Help

NetAgent Mini & NetAgent II

Local Modem

NetAgent

SMS

Information

Configuration

UPS Configuration

UPS On/Off Schedule

Network

SNMP

Email

SMS

Modem Port

NetFeeler II

WEB/Telnet

System Time

Language

Log Information

Help

SMS Settings

Send SMS When Event Occurs Use Local Modem

SMS Server

SMS Server Port 80

Account Name

Password

Sending test SMS 0955956637 Test SMS

Receiver cellular number(for Event Log)

Events

Remote Service

NetAgent

SMS

Information

Configuration

UPS Configuration

UPS On/Off Schedule

Network

SNMP

Email

SMS

Modem Port

NetFeeler II

WEB/Telnet

System Time

Language

Log Information

Help

SMS Settings

Send SMS When Event Occurs Use Remote Service

SMS Server 192.168.66.101

SMS Server Port 80

Account Name ttc

Password

Sending test SMS 0955956637 Test SMS

Receiver cellular number(for Event Log)			Events
Cellular Phone number 1			Select
Cellular Phone number 2			Select
Cellular Phone number 3			Select

- Mobile for Event Log

To set the recipient's mobile number for SMS notification when event or NetFeeler event occurs. A total of 8 mobile numbers can be assign.

NetAgent 9 Mini and NetAgent 9

The screenshot shows the NetAgent 9 configuration interface. The left sidebar contains navigation options: Information, Configuration, Log Information, and Help. The main area is titled 'Configuration > SMS' and 'SMS Setting Mobile for Event Log'. It features a list of 8 cellular phone numbers, each with a 'Select' button. Below this is a 'Select Event' dialog box with two tabs: 'UPS Events' and 'NetFeeler II'. The 'UPS Events' tab is active, showing a list of events with 'YES' and 'NO' radio buttons. A yellow box highlights the 'Select Event' dialog and the 'Apply' button in the main configuration area.

Cellular Phone number	Number	Select
Cellular Phone number1	0987924136	Select
Cellular Phone number2	0922725208	Select
Cellular Phone number3	0916461726	Select
Cellular Phone number4	0933988688	Select
Cellular Phone number5	0912334579	Select
Cellular Phone number6	0987300988	Select
Cellular Phone number7	0955670091	Select
Cellular Phone number8	0917577633	Select

Event	YES	NO
Schedule Shutdown Event	<input type="radio"/>	<input type="radio"/>
UPS Failure	<input checked="" type="radio"/>	<input type="radio"/>
UPS entering Test mode	<input checked="" type="radio"/>	<input type="radio"/>
UPS entering Sleeping mode	<input checked="" type="radio"/>	<input type="radio"/>
UPS entering Boost mode	<input checked="" type="radio"/>	<input type="radio"/>
UPS Load Overrun	<input checked="" type="radio"/>	<input type="radio"/>
UPS Communication Lost	<input checked="" type="radio"/>	<input type="radio"/>
Turn Off UPS	<input checked="" type="radio"/>	<input type="radio"/>
AC Power Failed	<input checked="" type="radio"/>	<input type="radio"/>
UPS Battery Low	<input checked="" type="radio"/>	<input type="radio"/>
UPS Temperature Overrun	<input checked="" type="radio"/>	<input type="radio"/>
UPS Capacity Underrun	<input checked="" type="radio"/>	<input type="radio"/>
UPS entering Bypass mode	<input checked="" type="radio"/>	<input type="radio"/>

NetAgent II and NetAgent Mini

The screenshot shows the NetAgent II configuration interface. The left sidebar contains navigation options: Information, Configuration, Log Information, and Help. The main area is titled 'SMS Settings' and includes fields for 'Send SMS When Event Occurs', 'SMS Server', 'SMS Server Port', 'Account Name', 'Password', and 'Sending test SMS'. Below this is a 'Receiver cellular number(for Event Log)' table with 8 rows, each with a 'Select' button. A yellow box highlights the 'Receiver cellular number' table and the 'Apply' button in the main configuration area.

Receiver cellular number(for Event Log)	Number	Select
Cellular Phone number 1	0987924136	Select
Cellular Phone number 2	0922725208	Select
Cellular Phone number 3	0916461726	Select
Cellular Phone number 4	0933988688	Select
Cellular Phone number 5	0912334579	Select
Cellular Phone number 6	0987300988	Select
Cellular Phone number 7	0955670091	Select
Cellular Phone number 8	0917577633	Select

■ Configuration > Web/Telnet

To set permission for each user account for Web and Telnet access. It is valid for up to 8 users.

● User account

User Name :

To set password for NetAgent Web and Telnet access.

Password :

To set password for NetAgent Web and Telnet access.

Permission :

To set No Access / Read/ Read&Write)

☀ Permission Rule : At least one user account must be Read/Write

☀ Permission Rule : User name with Read and Write cannot be blank

IP Filter :

Only specific IP address could login to NetAgent

☀ *.*.*.* means any IP address

Auto Logoff after Idle for minute (s). (0 is disabled)

NetAgent webpage will be logoff automatically if it idle for the preset value.

NetAgent 9 Mini & NetAgent 9

The screenshot displays the NetAgent 9 configuration interface. The left sidebar shows the navigation menu with 'Web/Telnet' selected. The main area is titled 'Configuration > Web / Telnet' and contains a 'User Account' tab. A table lists user accounts with their respective permissions and IP filters. A yellow box highlights the table and the 'Auto LogOff after idle for 3 minute(s) (0: Disable)' setting. A yellow arrow points from the 'Permission' column to a callout box showing 'No Access', 'Read', and 'Read/Write' options. Another yellow arrow points from the 'Auto LogOff' setting to a Windows Security dialog box that prompts for user name and password, warning that the connection is not secure.

User Name	Password	Permission	IP Filter
tony	Read/Write	****
rex	Read/Write	***
novia		Read	****
elma		Read/Write	****
toby	Read	192.168.66.86
ira	Read/Write	192.168.66.108
cynthia	Read/Write	192.168.66.33
		No Access	****

Auto LogOff after idle for minute(s) (0: Disable)

Windows Security

The server 192.168.66.103 is asking for your user name and password. The server reports that it is from 0:b.41e23d47.

Warning: Your user name and password will be sent using basic authentication on a connection that isn't secure.

User name:

Password:

Remember my credentials

⚠ Caps Lock is on

OK Cancel

NetAgent Mini & NetAgent II

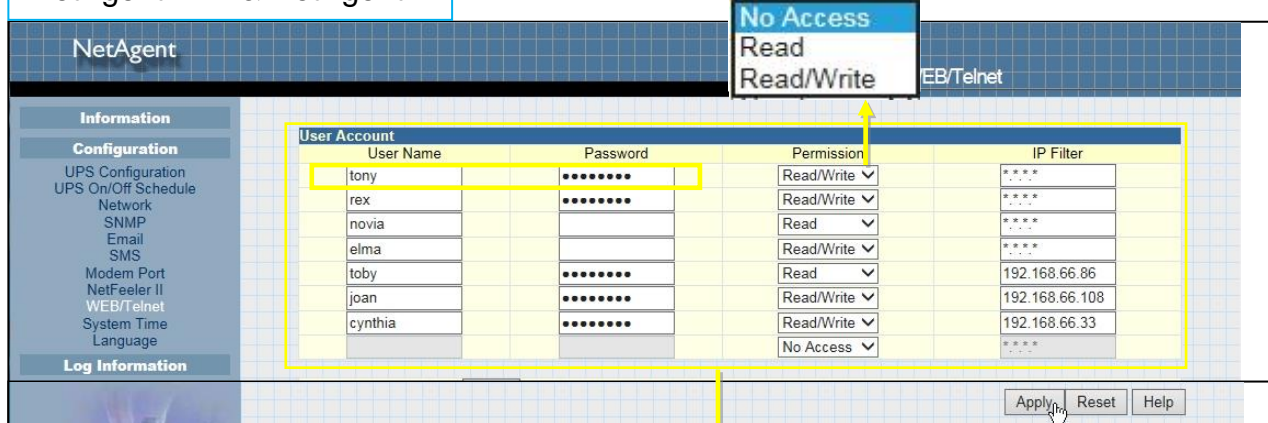

- SSL Information

NetAgent supports HTTPS protocol and varies SSL encryptions version for network connection. User may upload its Public Key and Certification for authentication

Table of SSL versions that NetAgent supports

	SSL v2	SSL v3	TLS v1.0	TLS v1.1	TLS v1.2
NetAgent9 & Mini	✓	✓	✓	✓	✓
NetAgent DT/CT/BT		✓			

HTTPS Protocols

Select the encryption version

- SSL v2
- SSL v3
- SSL v1.0
- SSL v1.1
- SSL v1.2

☛ Once click on Apply, NetAgent will reboot

SSL Information

This is to upload the SSL certificate. When both public key and certificate are uploaded to NetAgent web server, the communication will be encrypted by SSL

(To communicate via Https, make sure to enable Https port 443.)To create its own public key and certification, please refer to OpenSSL software in the CD

NetAgent 9 Mini & NetAgent 9

Configuration > Web / Telnet

User Account **SSL Information** RADIUS Server Settings

Select Encryption Version

HTTPS Protocol

- SSL v2
- SSL v3
- TLS v1.0
- TLS v1.1
- TLS v1.2

Apply * Reset

* : System will reboot when 'Apply' has been pressed.

1.Upload Public Key

SSL Information

SSL Public Key	G:\netagent9_key	瀏覽...	Upload and Replace
Public Key Length	1024 bits		
SSL Certificate	G:\netagent9_cert	瀏覽...	Upload and Replace
Issued To	NetAgent		
Issued By	NetAgent		
Valid From	2016-11-09		
Valid Until	2018-11-09		

2. Upload Certification

NetAgent Mini & NetAgent II

NetAgent

WEB/Telnet

Information

Configuration

- UPS Configuration
- UPS On/Off Schedule
- Network
- SNMP
- Email
- SMS
- Modem Port
- NetFeeler II
- WEB/Telnet
- System Time
- Language

Log Information

Help

Auto LogOff after idle for 3 minute(s) (0: Disable)

RADIUS Server Settings

Enable RADIUS in Web/Telnet login	NO
RADIUS Server Address	
Authentication Port	1812
Shared Key	
Connection TimeOut	5 second(s)
Connection Retry	3

Apply Reset Help

SSL Public Key Information

SSL Public Key	G:\NetAgentII_key	瀏覽...	Upload and Replace
Public Key Length	1024 bits		

SSL Certificate Information

SSL Certificate	G:\NetAgentII_cert	瀏覽...	Upload and Replace
Issued To	NetAgent		
Issued By	NetAgent		
Valid From	2014-04-24		
Valid Until	2016-04-23		

* : This upload function could not be used in HTTPS mode.

Internet Explorer

https://192.168.66.133

此網站的安全性憑證有問題。

此網站出示的安全性憑證並非由信任的憑證授權單位所發行。
此網站出示的安全性憑證是為其他網站的位址所發行的。

安全性憑證問題可能表示其他人可能正在嘗試欺騙您，或是攔截您傳送到該伺服器的任何資料。

我們建議您關閉此網頁，而且不要繼續瀏覽此網站。

- 按這裡關閉此網頁。
- 繼續瀏覽此網站 (不建議)。
- 其他資訊

When connect via HTTPS with its own generated public key and certification, browser may show error, please ignore and continue.

- RADIUS Server Setting

If RADIUS server authentication is required for the network, NetAgent could be added by entering following parameter.



Enable RADIUS in Web/Telnet Login:

To select if to enable RADIUS

RADIUS Server Address :

To enter the IP address of the RADIUS Server

Authentication Port :

RADIUS port number (Default is 812)

Shared Key :

Enter the Shared Key between RADIUS Server and client

Connection Timeout :

Set the number of seconds to suspend the login time after the RADIUS server is rejected

Connection Retry :

Sets the number of connections to the RADIUS server again

NetAgent 9 Mini & NetAgent 9

Configuration Item	Value
Enable RADIUS in Web/Telnet login	<input checked="" type="checkbox"/> YES
RADIUS Server Address	192.168.66.5
Authentication Port	1812
Shared Key
Connection TimeOut	5 second(s)
Connection Retry	3

NetAgent Mini & NetAgent II

NetAgent WEB/Telnet

Information

Configuration

- UPS Configuration
- UPS On/Off Schedule
- Network
- SNMP
- Email
- SMS
- Modem Port
- NetFeeler II
- WEB/Telnet
- System Time
- Language

Log Information

Help

Auto LogOff after idle for minute(s) (0: Disable)

RADIUS Server Settings

Enable RADIUS in Web/Telnet login	<input checked="" type="checkbox"/> YES
RADIUS Server Address	<input type="text" value="192.168.66.5"/>
Authentication Port	<input type="text" value="1812"/>
Shared Key	<input type="text" value="••••••••"/>
Connection TimeOut	<input type="text" value="5"/> second(s)
Connection Retry	<input type="text" value="3"/>

SSL Public Key Information

■ Configuration > System Time

This page is to set NetAgent's system time. NetAgent could synchronize with external or internal Time Server.

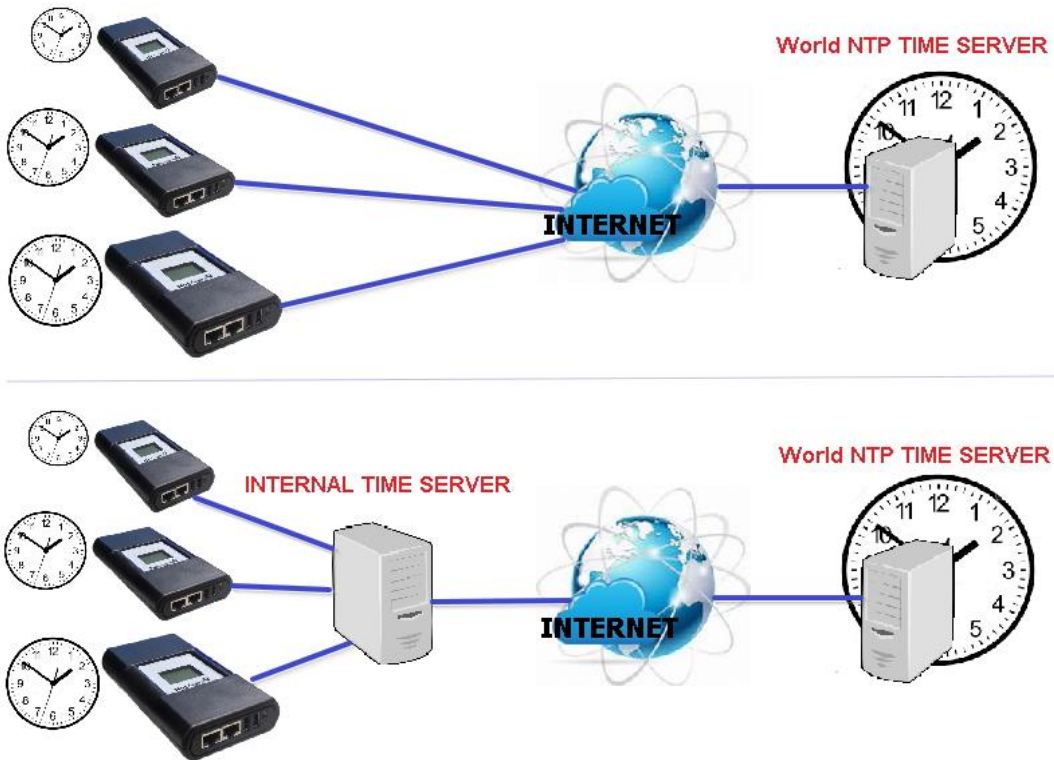

System Time

Time Between Automatic Updates :

To set an interval for time synchronization.

Time Server :

Time server can be select from the drop down list , or add other time server manually.

Time Zone(Relative to GMT) :

To select its GMT time zone

Using Daylight Saving Time :

Select whether to use the daylight saving time system to adjust the clock for 1 hour in advanced

System Time(yyyy/mm/dd hh:mm:ss) :

To display the current system time/date of NetAgent. Or click on Adjust Now to adjust to the correct time/date automatically

Restart

Auto Restart System for Every (0 is disabled):

NetAgent to restart automatically at preset hour or minute

Manual Restart System After 30 seconds :

Once click on Apply, NetAgent would restart after 30 seconds

NetAgent 9 Mini & NetAgent 9

1. Select Time Server

2. Adjust Now

Add Time Server

NetAgent 9 Mini & NetAgent 9

1. Select Time Server

2. Adjust Time

Add Time Server

■ Configuration > SMS Modem

□ Modem Setup Procedure

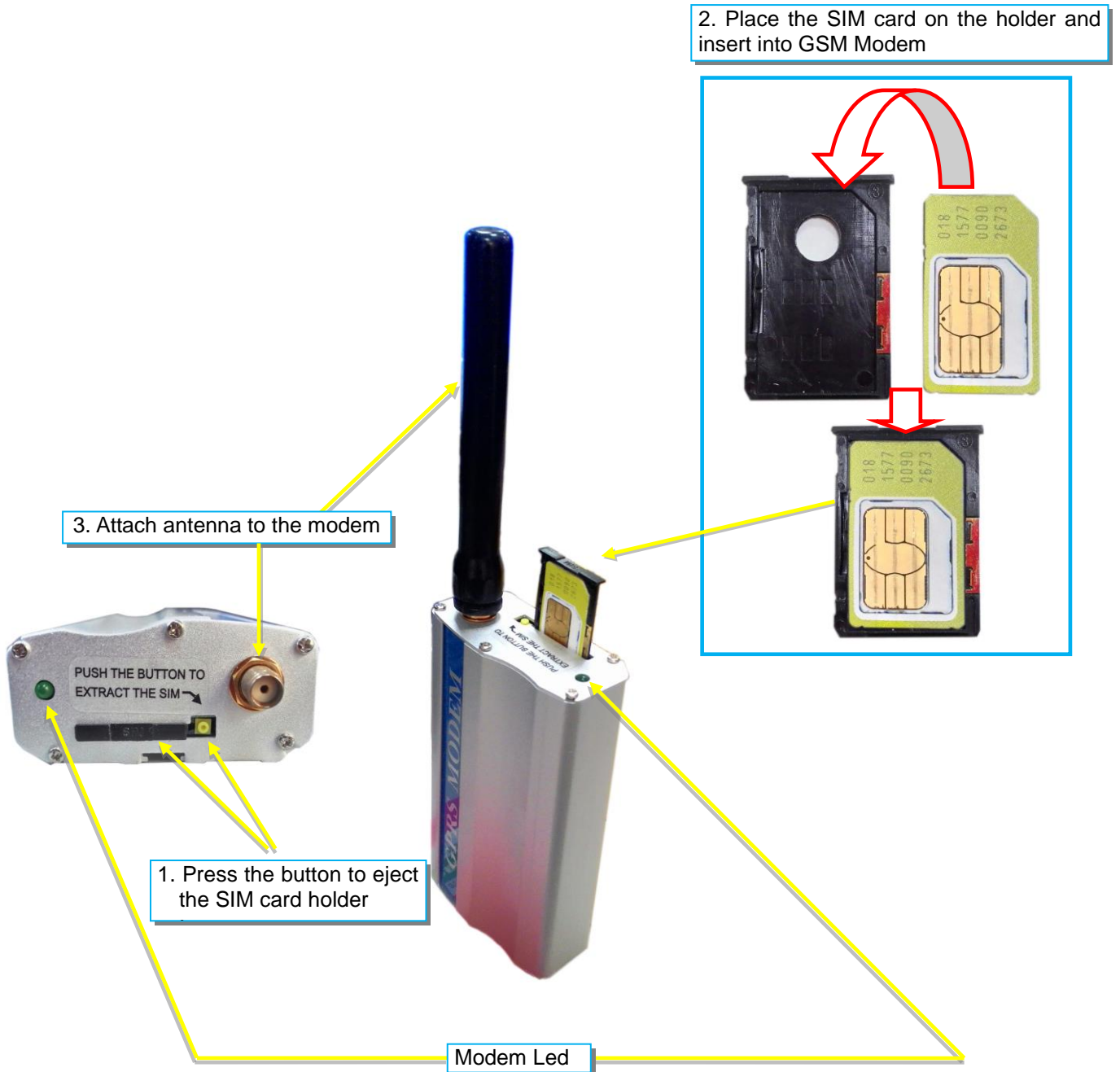

Modem Led Status

- If flash every 0.8 seconds :**
 - Modem initializing, please wait
 - If no respond
 - (1) Check if PIN is correctly entered, or if PIN is required
 - (2) Check if SIM card is inserted corrected
 - (3) Check if no or low signal
- If flash every 3 seconds :**
 - Modem is ready for operation



Adaptor

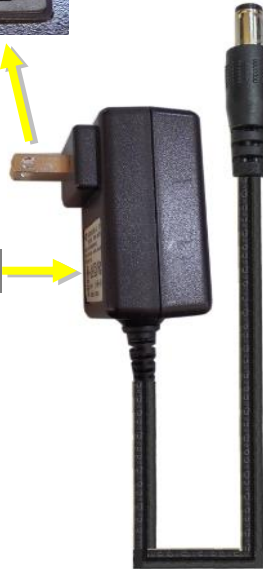

2906 Cable



USB Cable



NetAgent II 3 Ports



NetAgent 9

- SMS Modem Settings

Modem Communication Port :

Select “ ttyUSB0” for USB modem connects with NetAgent 9 directly ;

Select “SMS “ for modem connects with NetAgent II 3 Ports

SMS Communication :

Select between GPRS or CDMA

SIM Card PIN :

If PIN is required for the SIM card, please enter

Confirm SIM PIN :

Retype SIM card PIN

When all done, click on Apply. Modem Information and Status can be check from Information> SMS Modem Status

☀ Once click on Apply on NetAgent 3 ports model, NetAgent will reboot

NetAgent 9 W/USB

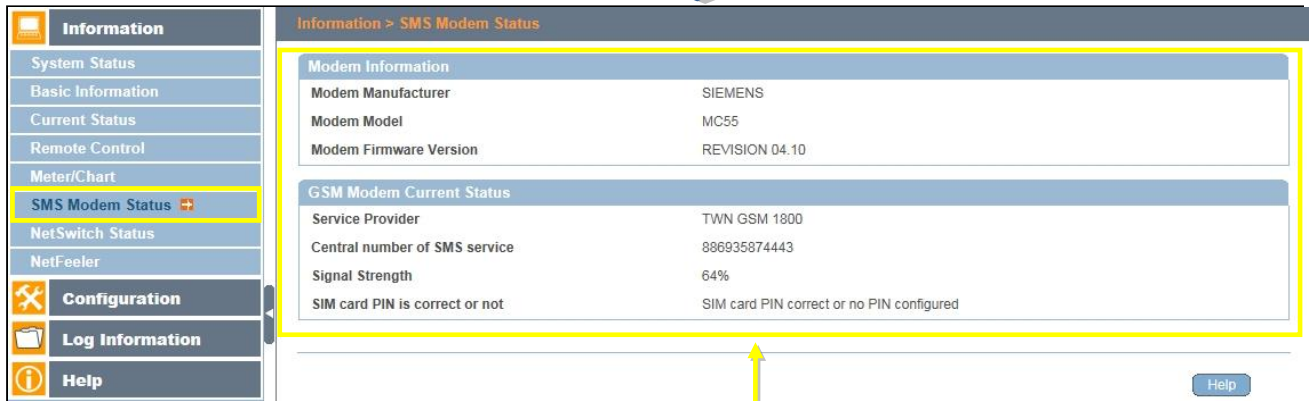
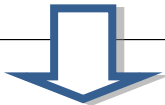
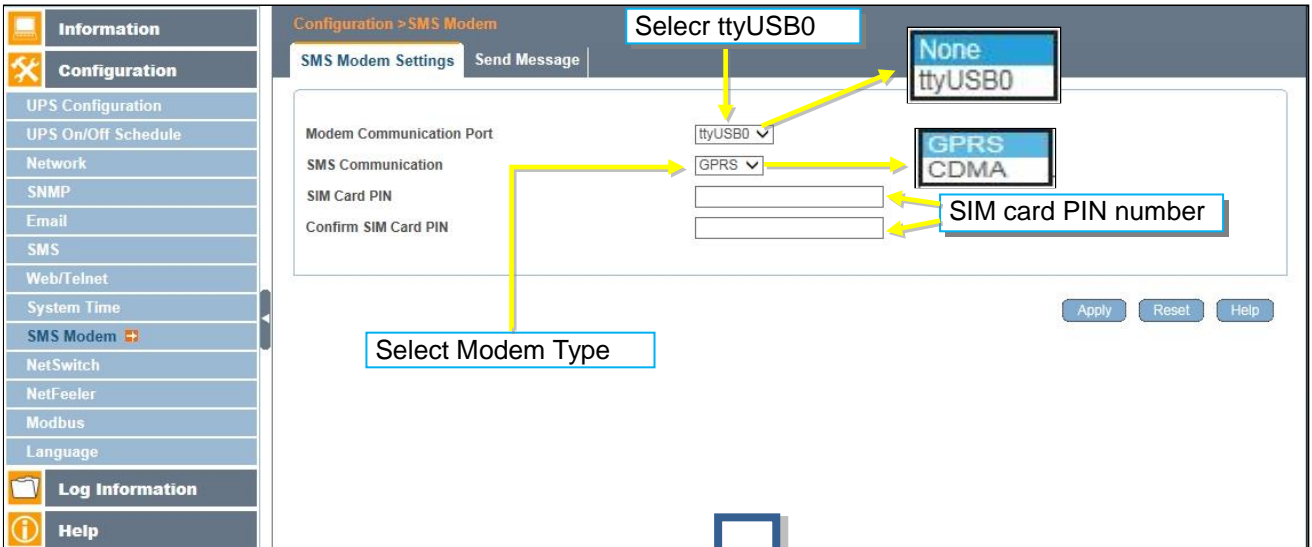

Modem Information and Status

- Send Message

Cellular Phone number :

Enter mobile number

SMS Content(Max.70 Characters) :

Enter the SMS content text and select coding. Unicode or Character



NetAgent II 3 Ports

NetAgent

Modem Port

Information

Configuration

UPS Configuration
UPS On/Off Schedule
Network
SNMP
Email
SMS
Modem Port
NetFeeler II
WEB/Telnet
System Time
Language

Log Information

Help

Select Modem Type

Select SMS]

SMS
PPP Dial-in
NetSwitch

Modem Settings

Modem Communication Type* SMS

SMS Settings

SMS Communication GPRS

SIM Card PIN

Confirm SIM Card PIN

GPRS
CDMA

SIM card PIN number

*: System will reboot when this item has been Applied.

Apply Reset Help

Receiver cellular number and message content

Cellular Phone number 09886705898

SMS content TESTSMS

Unicode Character

Send Reset Help

Enter the mobile number and SMS content, then click on Send

NetAgent

Modem Information and Status

Modem Status

Information

System Status
Basic Information
Current Status
Remote Control
Meter/Chart
Modem Status

Configuration

Log Information

Help

Modem Information

Modem Manufacturer	SIEMENS
Modem Model	MC55
Modem Firmware Version	REVISION 04.00

GSM Modem Current Status

Service Provider	TWN GSM 1800
Central number of SMS service	886935874443
Signal Strength	38%
SIM card PIN is correct or not	SIM card PIN correct or no PIN configured

Help

■ Configuration > NetSwitch

NetAgent 3 Ports (BT model) or NetAgent 9 (BX/BY model) can also connect with our NetSwitch for remote power management

□ NetSwitch Installation

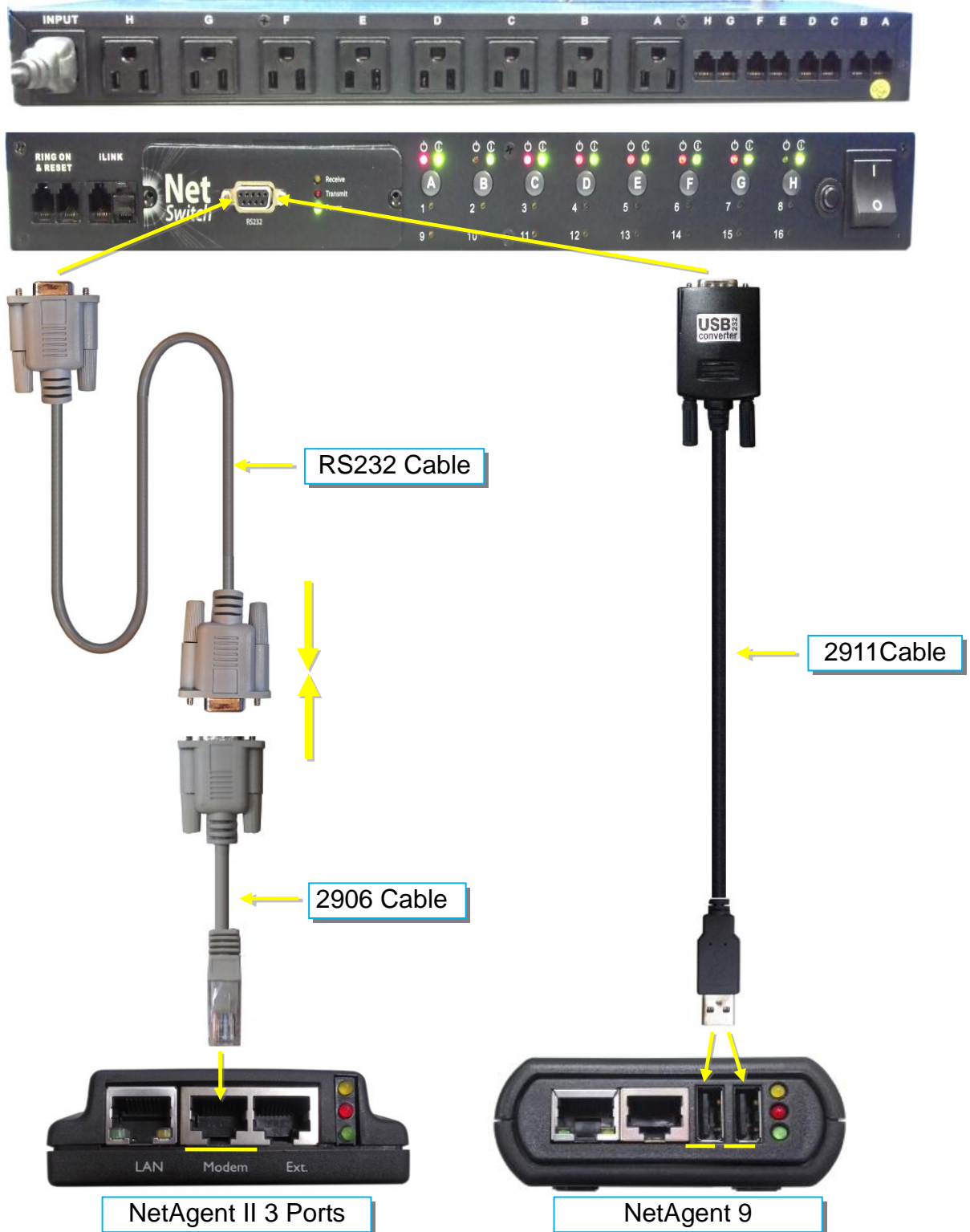

- NetSwitch

When NetAgent BT/BX/BY connects with NetSwitch, it able to perform action to the specific outlet when event or alarm triggers

NetAgent 9

Configuration > NetSwitch

Current Action List

No.	Events	Events Action	NetSwitch	Outlet	Outlet Action	Modify
1	UPS Load Overrun	Occur	NetSwitch01(iSWITCH)	OutletF(EPSON PRINTER)	OFF	[Delete]
2	UPS Load Overrun	Occur	NetSwitch01(iSWITCH)	OutletG(HP PRINTER)	OFF	[Delete]
3	AC Power Failed	Occur	NetSwitch01(iSWITCH)	OutletB(COMPUTER A)	OFF	[Delete]
4	AC Power Failed	Occur	NetSwitch01(iSWITCH)	OutletC(COMPUTER B)	OFF	[Delete]
5	AC Power Failed	Occur	NetSwitch01(iSWITCH)	OutletD(MAIL SERVER)	OFF	[Delete]
6	AC Power Failed	Occur	NetSwitch01(iSWITCH)	OutletE(DNS SERVER)	OFF	[Delete]
7	UPS Load Overrun	Remove	NetSwitch01(iSWITCH)	OutletF(EPSON PRINTER)	ON	[Delete]
8	UPS Load Overrun	Remove	NetSwitch01(iSWITCH)	OutletG(HP PRINTER)	ON	[Delete]
9	AC Power Failed	Remove	NetSwitch01(iSWITCH)	OutletD(MAIL SERVER)	ON	[Delete]
10	AC Power Failed	Remove	NetSwitch01(iSWITCH)	OutletE(DNS SERVER)	ON	[Delete]

Delete Action

1. Click on Add to add new action

Add Help

2. Select Event

3. Event Action

4. Select NetSwitch Number

5. Select Outlet Number

6. Select Outlet Action

7. Click on Apply to add into Action list

Configuration > NetSwitch Action > NetSwitch Action Configuration

NetSwitch Action Configuration

Events Select: UPS

Events Action: Occur Remove

NetSwitch: NetSwitch01(iSWITCH)

Outlet: OutletA(ADSL MODEM)

Outlet Action: ON OFF

Apply

OutletA(ADSL MODEM)
 OutletA(COMPUTER A)
 OutletA(COMPUTER B)
 OutletA(MAIL SERVER)
 OutletA(DNS SERVER)
 OutletA(EPSON PRINTER)
 OutletA(HP PRINTER)
 OutletA(EMERGENCY LIGHT)

NetSwitch02
 NetSwitch03
 NetSwitch04
 NetSwitch05
 NetSwitch06
 NetSwitch07
 NetSwitch08
 NetSwitch09
 NetSwitch10
 NetSwitch11
 NetSwitch12
 NetSwitch13
 NetSwitch14
 NetSwitch15
 NetSwitch16

UPS
 UPS Load Overrun
 UPS Communication Lost
 AC Power Failed
 UPS Battery Low
 UPS Temperature Overrun
 Battery Capacity Below to
 -----NetFeeler II-----
 Temperature Overrun
 Temperature Underrun
 Humidity Overrun
 Humidity Underrun
 Water
 Smoke
 Gas
 Security1
 Security2
 Security3
 Security4
 Security5
 Security6
 Security7

NetAgent II 3 Ports

NetAgent

Current Action List

NetSwitch Action

Delete Action

No.	Events	Events Action	NetSwitch	Outlet	Outlet Action	Modify
1	UPS Load Overrun	Occur	NetSwitch01(iSWITCH)	OutletF(EPSON PRINTER)	OFF	[Delete]
2	UPS Load Overrun	Occur	NetSwitch01(iSWITCH)	OutletG(HP PRINTER)	OFF	[Delete]
3	AC Power Failed	Occur	NetSwitch01(iSWITCH)	OutletB(COMPUTER A)	OFF	[Delete]
4	AC Power Failed	Occur	NetSwitch01(iSWITCH)	OutletC(COMPUTER B)	OFF	[Delete]
5	AC Power Failed	Occur	NetSwitch01(iSWITCH)	OutletD(MAIL SERVER)	OFF	[Delete]
6	AC Power Failed	Occur	NetSwitch01(iSWITCH)	OutletE(DNS SERVER)	OFF	[Delete]
7	UPS Load Overrun	Remove	NetSwitch01(iSWITCH)	OutletF(EPSON PRINTER)	ON	[Delete]
8	UPS Load Overrun	Remove	NetSwitch01(iSWITCH)	OutletG(HP PRINTER)	ON	[Delete]
9	AC Power Failed	Remove	NetSwitch01(iSWITCH)	OutletD(MAIL SERVER)	ON	[Delete]
10	AC Power Failed	Remove	NetSwitch01(iSWITCH)	OutletE(DNS SERVER)	ON	[Delete]

1. Click on Add to add new action

New Help

2. Select Event

3. Event Action

4. Select NetSwitch Number

5. Select Outlet Number

6. Select Outlet Action

7. Click on Apply to add into Action list

NetSwitch Action Configuration

Events Select: UPS

Events Action: Occur Remove

NetSwitch: NetSwitch01(iSWITCH)

Outlet: OutletA(ADSL MODEM)

Outlet Action: ON OFF

Apply

OutletA(ADSL MODEM)

OutletA(COMPUTER A)

OutletA(COMPUTER B)

OutletA(MAIL SERVER)

OutletA(DNS SERVER)

OutletA(EPSON PRINTER)

OutletA(HP PRINTER)

OutletA(EMERGENCY LIGHT)

NetSwitch02

NetSwitch03

NetSwitch04

NetSwitch05

NetSwitch06

NetSwitch07

NetSwitch08

NetSwitch09

NetSwitch10

NetSwitch11

NetSwitch12

NetSwitch13

NetSwitch14

NetSwitch15

NetSwitch16

UPS

UPS Load Overrun

UPS Communication Lost

AC Power Failed

UPS Battery Low

UPS Temperature Overrun

Battery Capacity Below to

NetFeeler II

Temperature Overrun

Temperature Underrun

Humidity Overrun

Humidity Underrun

Water

Smoke

Gas

Security1

Security2

Security3

Security4

Security5

Security6

Security7

- NetSwitch Settings

NetSwitchCommunication Port :

Select “ ttyUSB0” for NetSwitch connects with NetAgent 9 directly ;

Select “NetSwitch “ for NetSwitch connects with NetAgent II 3 Ports

☀ **Once click on Apply on NetAgent 3 ports model, NetAgent will reboot**

Select NetSwitch :

Select the NetSwitch number (0~16)

Address Change :

To adjust the current NetSwitch number (e.g : NetSwitch01 → NetSwitch03)

Identication :

NetSwitch’s ID name

Outlet :

Each NetSwitch as 8 individual outlet with code of A~H

Name :

To enter a name for each outlet for identification

Phone Controllable :

If to control by phone coding (Refer to NetSwitch manual)

Control Type :

The action of each outlet. Safe Shutdown / Safe reboot / Instant Shutdown (Refer to NetSwitch manual for definition of each outlet)

Power Off Delay :

When select safe shutdown and safe reboot, this is to set power off delay for the outlet

Power Resume Daly :

When AC recovers , the time to resume power on the outlet

NetAgent 9

Configuration > NetSwitch

NetSwitch Settings

NetSwitch Communication Port: ttyUSB0

Select NetSwitch: NetSwitch01(iSWITCH)

Address Change: []

Identification: iSWITCH

Outlet	Name	Phone Controllable	Control Type	Power Off Delay	Power Resume Delay
A	ADSL MODEM	YES	safe shutdown	180 sec	30 sec
B	COMPUTER A	YES	safe shutdown	90 sec	30 sec
C	COMPUTER B	YES	safe shutdown	90 sec	30 sec
D	MAIL SERVER	YES	safe reboot	90 sec	30 sec
E	DNS SERVER	YES	safe reboot	90 sec	30 sec
F	EPSON PRINTER	YES	instant shutdown	0 sec	0 sec
G	HP PRINTER	YES	instant shutdown	0 sec	0 sec
H	EMERGENCY LIGHT	NO	instant shutdown	0 sec	0 sec

Apply Reset

NetAgent II 3 Ports

Modem Settings
Modem Communication Type* NetSwitch

*: System will reboot when this item has been Applied.

NetSwitch Setting
Select NetSwitch NetSwitch01
Address Change
Identification iSWITCH

Outlet	Name	Phone Controllable	Control Type	Power Off Delay	Power Resume Delay
A	ADSL MODEM	YES	safe shutdown	180 sec	30 sec
B	COMPUTER A	YES	safe shutdown	90 sec	30 sec
C	COMPUTER B	YES	safe shutdown	90 sec	30 sec
D	MAIL SERVER	YES	safe reboot	90 sec	30 sec
E	DNS SERVER	YES	safe reboot	90 sec	30 sec
F	EPSON PRINTER	YES	instant shutdown	0 sec	0 sec
G	HP PRINTER	YES	instant shutdown	0 sec	0 sec
H	EMERGENCY LIGHT	NO	instant shutdown	0 sec	0 sec



Information > NetSwitch Status

NetSwitch Status and Control

Select NetSwitch: NetSwitch01 (iSWITCH)
Identification: iSWITCH

Outlet	Status	Power Icon
OutletA	ON	[ON Icon]
OutletB	OFF	[OFF Icon]
OutletC	ON	[ON Icon]
OutletD	ON	[ON Icon]
OutletE	ON	[ON Icon]
OutletF	ON	[ON Icon]
OutletG	ON	[ON Icon]
OutletH	ON	[ON Icon]

NetAgent NetSwitch Status

NetSwitch Status and Control (Click the icon to turn on or off the specific outlet)

Select NetSwitch: NetSwitch01
Identification: iSWITCH

Outlet	Status	Power Icon
OutletA	ON	[ON Icon]
OutletB	OFF	[OFF Icon]
OutletC	ON	[ON Icon]
OutletD	ON	[ON Icon]
OutletE	ON	[ON Icon]
OutletF	ON	[ON Icon]
OutletG	ON	[ON Icon]
OutletH	ON	[ON Icon]

All On [ON Icon]
All Off [OFF Icon]

■ **Configuration > NetFeeler**

NetFeeler is the external optional environmental sensor, It is to detects temperature, humidity and water. Inside NetFeeler, it has RF receiver to work with extension sensors such as smoke, security sensor.

□ NetFeeler Setup

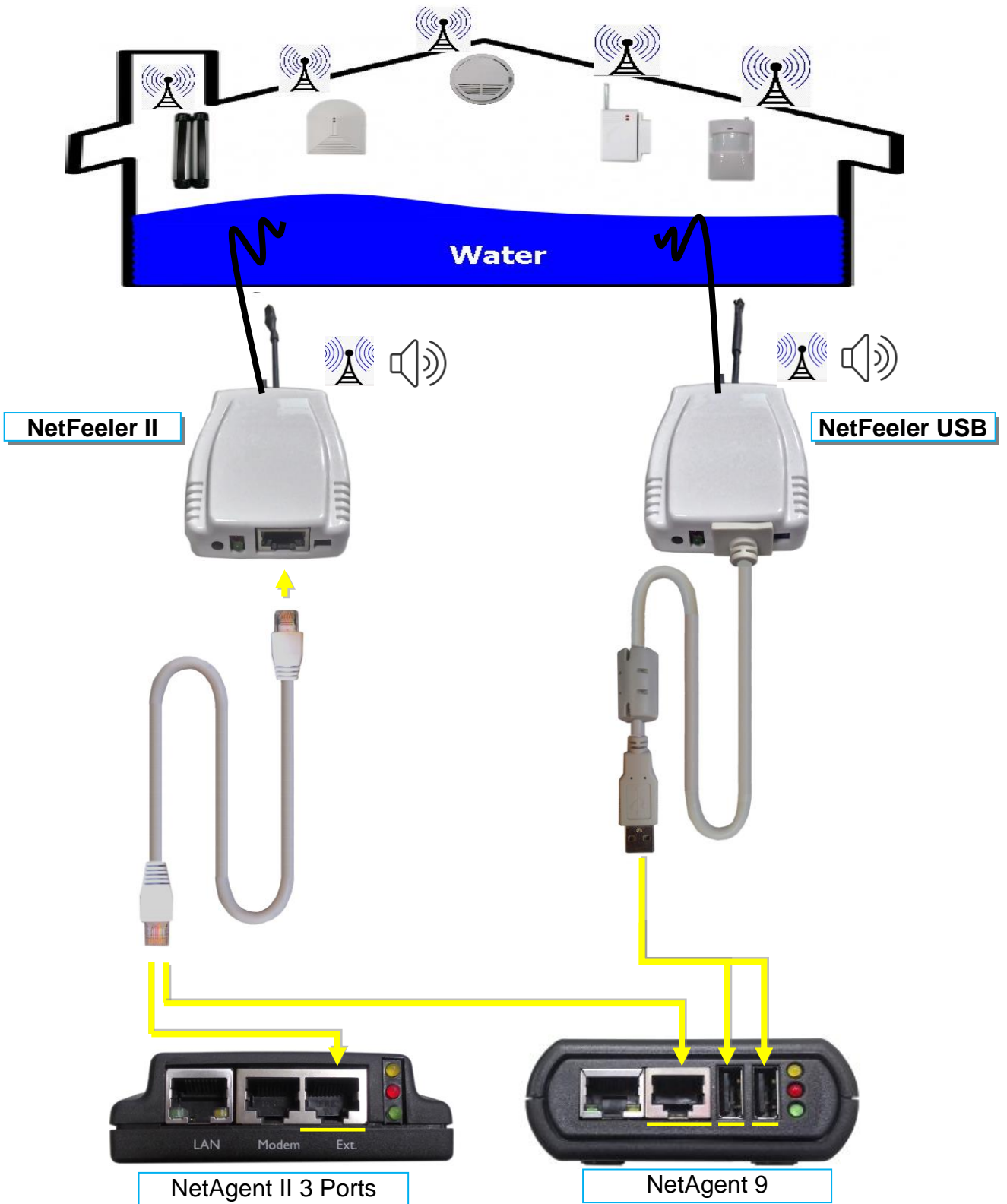

NetFeeler

NetFeeler :

To select NetFeeler type. NetFeeler II / NetFeeler USB

☛ NetAgent 9 can use with NetFeeler II or NetFeeler USB

☛ NetAgent II 3 Ports only to use with NetFeeler II

Humidity/Temperature Critical value :

To set the lowest and highest critical values for temperature and humidity. NetFeeler II will send a warning message when it detects temperature or humidity values below and above these settings.

Security Label

NetFeeler may connect up to 7 security sensors that communicates via RF. This section is to set the location or name of each sensor.

NetAgent 9

Configuration > NetFeeler

NetFeeler

NetFeeler: NetFeeler II

Humidity (%): 40

Temperature (°C): 10.0

Critical UnderRun

Critical OverRun: 90

Security Label

Label 1	Factory gate
Label 2	Factory back door
Label 3	Office floor windows
Label 4	Finance Dept window(left)
Label 5	Finance Dept window(right)
Label 6	Warehouse door
Label 7	Garage door

Apply Reset Help

Information > NetFeeler

NetFeeler Status

Environmental Temperature	25.0 °C (77.0 °F)	Factory gate	Normal
Environmental Humidity	60 %	Factory back door	Normal
Water Status	Normal	Office floor windows	Normal
Gas Status	Normal	Finance Dept window(left)	Normal
Smoke Status	Normal	Finance Dept window(right)	Normal
		Warehouse door	Normal
		Garage door	Normal

Clear Alarm Reset Alarm Help

NetAgent II 3 Ports

NetAgent NetFeeler II

Information

Configuration

- UPS Configuration
- UPS On/Off Schedule
- Network
- SNMP
- Email
- SMS
- Modem Port
- NetFeeler II
- NetSwitch Action
- WEB/Telnet
- System Time
- Language

Log Information

Help

NetFeeler II

	Critical UnderRun	Critical OverRun
Humidity (%)	40	90
Temperature (°C)	10.0	45.0

Security Label

Label 1	Factory gate
Label 2	Factory back door
Label 3	Office floor windows
Label 4	Finance Dept windows(left)
Label 5	Finance Dept windows(right)
Label 6	Warehouse door
Label 7	Garage door

Apply Reset Help



NetAgent NetFeeler II

Information

- System Status
- Basic Information
- Current Status
- Remote Control
- Meter/Chart
- NetSwitch Status
- NetFeeler II**

Configuration

Log Information

Help

Refresh status every 10 seconds

NetFeeler II Status

Environmental Temperature	27.3 °C (81.1 °F)
Environmental Humidity	70 %
Water Status	Normal
Gas Status	Normal
Smoke Status	Normal
Factory gate	Normal
Factory back door	Normal
Office floor windows	Normal
Finance Dept windows(left)	Normal

NetAgent NetFeeler II

Information

- System Status
- Basic Information
- Current Status
- Remote Control
- Meter/Chart
- NetSwitch Status
- NetFeeler II**

Configuration

Log Information

Help

Refresh status every 10 seconds

NetFeeler II Status

Environmental Temperature	27.8 °C (82.0 °F)
Environmental Humidity	69 %
Water Status	Normal
Gas Status	Normal
Smoke Status	Normal
Factory gate	Normal
Factory back door	Normal
Office floor windows	Normal
Finance Dept windows(left)	Normal
Finance Dept windows(right)	Alarm
Warehouse door	Normal
Garage door	Normal

Clear Alarm Reset Alarm Help

■ **Configuration > MODBUS**

NetAgent supports Modbus on TCP/IP. And NetAgent 9 BY model also supports ModBus on RS485. Through Ethernet and serial communication, it may read multi UPS's data.

Connection illustration as below

□ RS485 2 lines connection(Half Duplex)

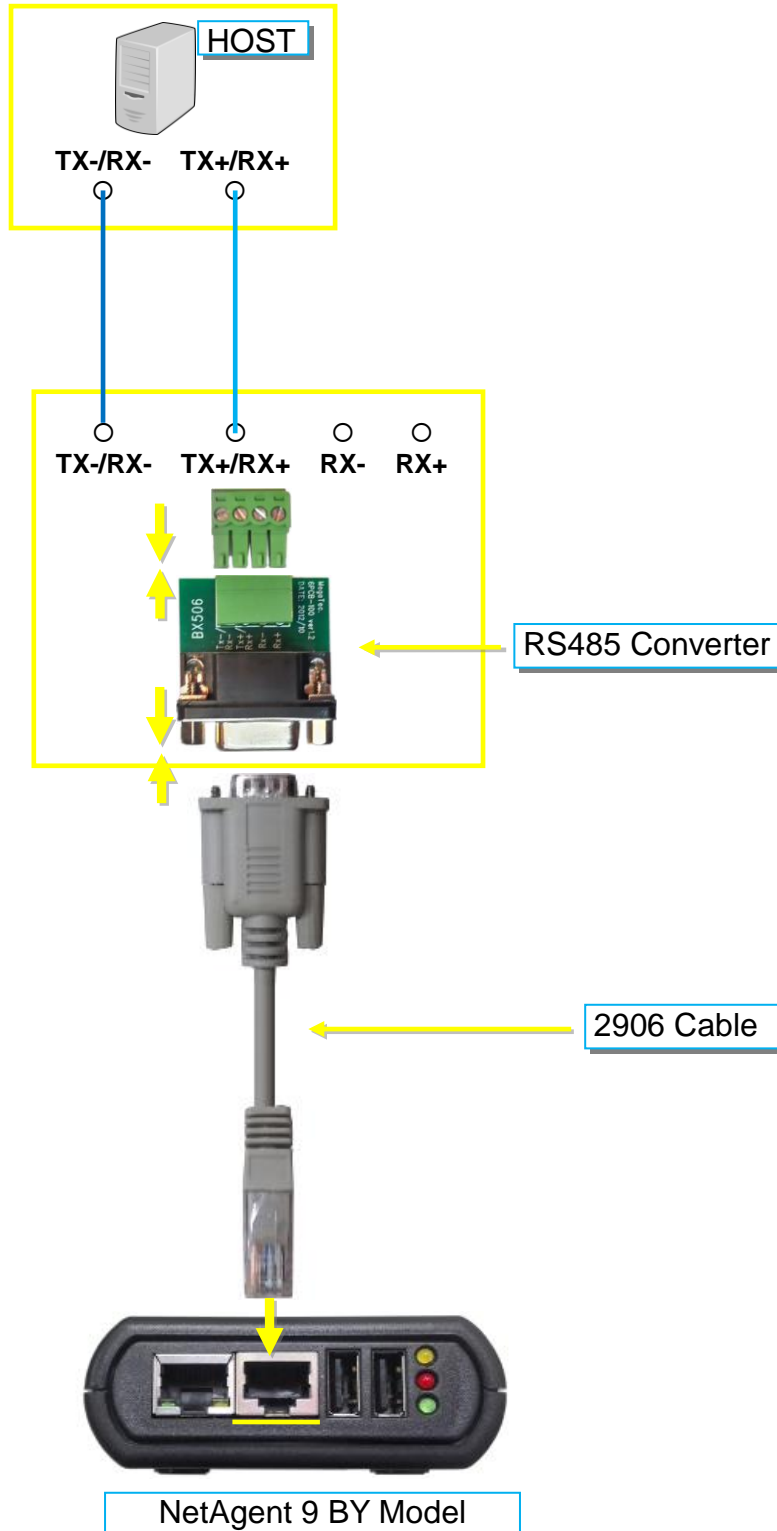

□ RS485 4 lines (Full Duplex)

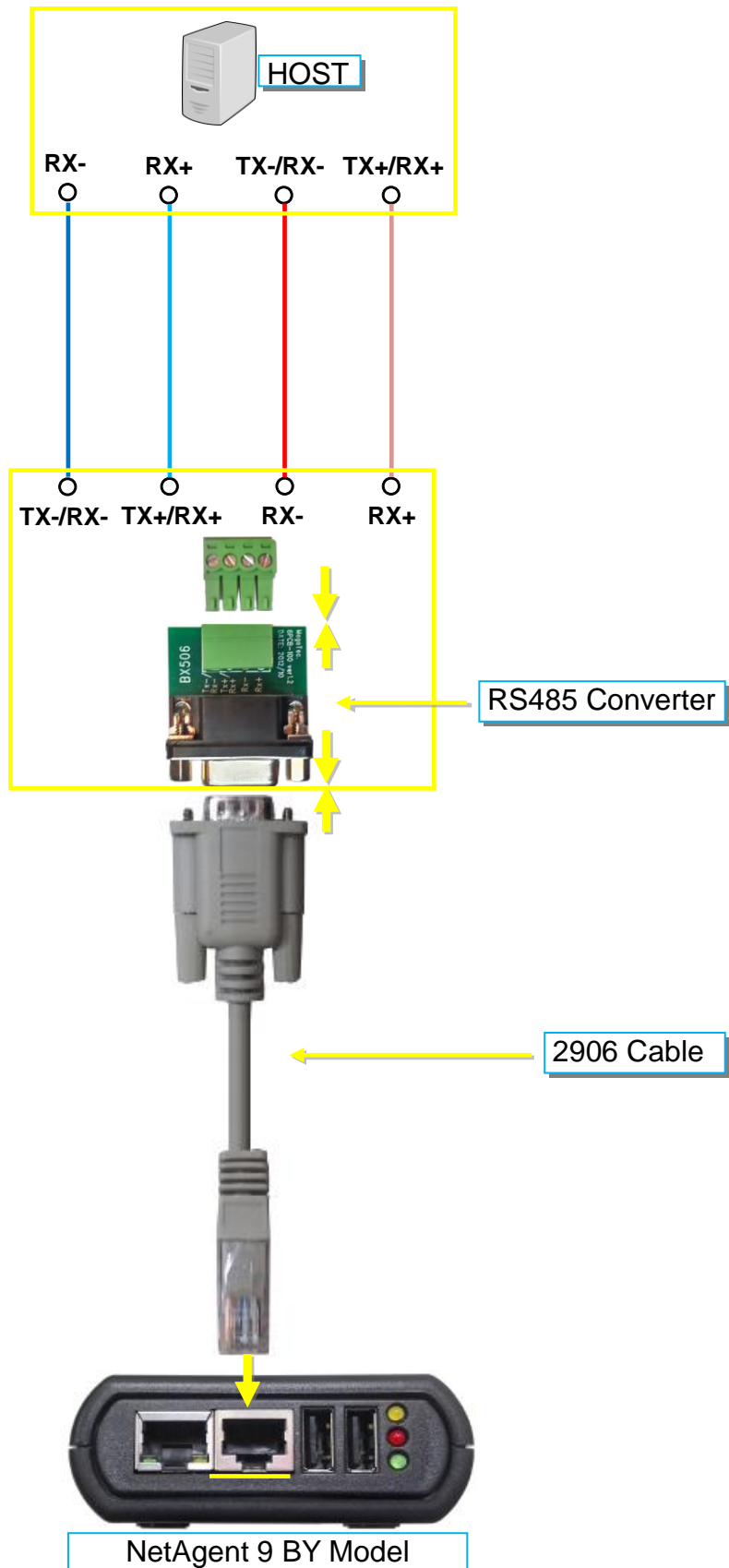

Modbus on TCP

Modbus on TCP Device ID :

Enter device ID to read/write data when using Modbus on TCP communication

Modbus on RS485

Transmission Mode :

To select Modbus communication code RTU or ASCII

Device ID :

Enter device ID

Mode :

To select communicate mode of Full Duplex and Half Duplex

Baud Rate :

Baud Rate of 2400 / 4800 / 9600 / 19200 / 38400 / 57600 bps

Data bits :

Data bits of 8 bits / 7 bits

Parity :

Parity of None/ odd /even

Stop bits :

Stop bits of 1 / 2

NetAgent 9

The screenshot displays the 'Configuration > Modbus' page in NetAgent 9. It is divided into two main sections: 'Modbus on TCP' and 'Modbus on RS485'.
- **Modbus on TCP:** Features a 'Modbus on TCP Device ID' input field with the value '1'.
- **Modbus on RS485:** Contains several configuration options:
 - **Transmission Mode:** A dropdown menu currently set to 'RTU'. A callout box points to the 'Disabled RTU ASCII' option.
 - **Device ID:** An input field with the value '1'.
 - **Mode:** A dropdown menu currently set to 'Full Duplex'. A callout box points to the 'Full Duplex Half Duplex' option.
 - **Baud Rate:** A dropdown menu currently set to '9600'. A callout box points to the '9600' option in the list.
 - **Data bits:** A dropdown menu set to '8'.
 - **Parity:** A dropdown menu set to 'None'.
 - **Stop bits:** A dropdown menu set to '1'.
At the bottom right of the configuration area, there are three buttons: 'Apply' (highlighted with a yellow box), 'Reset', and 'Help'. A vertical sidebar on the left contains navigation options like 'Information', 'Configuration', 'UPS Configuration', 'Network', 'SNMP', 'Email', 'SMS', 'Web/Telnet', 'System Time', 'SMS Modem', 'NetSwitch', 'NetFeeler', 'Modbus', 'Language', 'Log Information', and 'Help'.

■ Configuration > Language

This page is to set the language interface for NetAgent.

Interface Language

To set the language of NetAgent web pages. When first start login to the webpage of NetAgent, NetAgent will auto detects the OS language of the PC and shows the same language on its web pages. Users may choose the language per preference

Note: Users will have to enable cookies before they use this function.

Email Preference

Select language preference when receive emails and SMS.

Languages supported by NetAgent

NetAgent 9

- English
- Deutsch
- Português
- Español
- Français
- Italiano
- Türkçe
- 繁體中文
- 簡體中文
- 한글
- 日本語
- Русский
- ไทย
- Polska

NetAgent II

EAST Version

- English
- 繁體中文
- 簡體中文
- 한글
- 日本語
- Русский
- ไทย

WEST Version

- English
- Deutsch
- Português
- Español
- Français
- Italiano
- Русский
- Türkçe
- Polska

NetAgent 9 Mini & NetAgent 9

The screenshot shows the 'Configuration > Language' page. On the left is a navigation menu with 'Language' selected. The main content area has 'Interface Language' with radio buttons for English, Deutsch, Português, Español, Français, Italiano, Türkçe, 繁體中文, 簡體中文, 한글, 日本語, Русский, ไทย, and Polska. Below this is an 'Email Preferences' section with a dropdown menu set to 'English'. A yellow arrow points from the 'Apply' button to the dropdown menu. The 'Apply' button is highlighted with a yellow box.

■ **Log Information > Event Log**

It shows record of all events, giving the Date/Time of the event and a detailed description of each. Log capacity is 1000 logs. When reach to the limit, it rewrites on the previous logs. Log can be save as csv file.

csv file name as below

NetAgent 9 → eventlog_year/month.csv , e.g.:eventlog_201706

NetAgent II → eventlog.csv , e.g. : eventlog.csv

NetAgent 9 Mini & NetAgent 9

The screenshot shows the 'Log Information > Event Log' interface. On the left is a navigation menu with 'Event Log' selected. The main area displays a table of events with columns 'Date/Time' and 'Event'. A date filter dropdown is set to '2017/06'. A calendar pop-up shows the months 2017/06, 2017/07, and 2017/08. Below the table are 'Save', 'Clear...', and 'Help' buttons. Annotations include 'Check event by year/month' pointing to the date filter, and 'save.csv file' pointing to the 'Save' button.

Date/Time	Event
2017/06/27 12:06:51	UPS communication has been lost.
2017/06/27 10:47:25	Utility power has been restored.
2017/06/27 10:47:05	UPS has switched to battery power.
2017/06/27 10:46:44	Internal diagnostic self-test passed.
2017/06/27 10:46:28	Internal diagnostic self-test failed.
2017/06/27 10:46:24	The UPS return from...
2017/06/27 10:45:03	The UPS has return...
2017/06/27 10:45:03	The UPS is enterin...
2017/06/27 10:44:38	battery are very low...
2017/06/27 10:44:14	Utility power has been restored.
2017/06/27 10:44:08	UPS has switched to battery power.

The screenshot shows the 'Log Information > Event Log' interface with a list of files: eventlog_201706.dat, eventlog_201707.dat, and eventlog_201708.dat. Each file has a checkbox. Below the list are 'Select All', 'Clear All', and 'Delete' buttons. Annotations include '1. Select dat. file to delete' pointing to the first checkbox and '2. Delete' pointing to the 'Delete' button.

NetAgent Mini & NetAgent II

The screenshot shows the 'NetAgent Event Log' interface. On the left is a navigation menu with 'Event Log' selected. The main area displays a table of events with columns 'Date/Time' and 'Event'. Below the table are 'Clear all log', 'Save', and 'Help' buttons. Annotations include 'Clear all log' pointing to the 'Clear all log' button and 'save.csv file' pointing to the 'Save' button.

Date/Time	Event
2017/06/27 18:10:21	UPS passed internal self-test.
2017/06/27 18:00:28	UPS Test
2017/06/27 17:54:55	UPS communication has been established.
2017/06/27 10:00:18	UPS communication has been lost.
2017/06/27 09:57:20	UPS has switched to battery power.
2017/06/27 09:57:17	UPS communication has been established.
2017/06/27 09:54:19	UPS communication has been lost.
2017/06/27 09:51:22	UPS has switched to battery power.
2017/06/27 09:49:31	UPS communication has been established.
2017/06/27 08:51:50	NetSwitch Communication Lost
2017/06/27 08:51:49	UPS communication has been lost.
2017/06/26 19:01:50	Security5 Alarm

■ Log Information > SMS Log

It shows SMS record of all mobile number, giving the Date/Time of the SMS sent and a detailed description of each. Log capacity is 1000 logs. When reach to the limit, it rewrites on the previous logs.

NetAgent 9 model of BX/BY can save the SMS log as csv file.

csv file as below

smslog_year/month.csv , e.g : smslog_201706.csv

NetAgent 9

- Information
- Configuration
- Log Information
 - Event Log
 - SMS Log**
 - Data Log
 - Battery Test Log
- Help

Log Information > SMS Log
SMS Log

Date/Time	Mobile Number	SMS Content
2017/06/27 18:34:28	0955055657	UPS Agent(My Office)<192.168.66.102>:The UPS has returned from a low battery.
2017/06/27 18:34:19	0917461725	UPS Agent(My Office)<192.168.66.102>:The UPS has returned from a low battery.
2017/06/27 18:34:09	0922725209	UPS Agent(My Office)<192.168.66.102>:The UPS has returned from a low battery.
2017/06/27 18:34:00	0955055657	UPS Agent(My Office)<192.168.66.102>:The UPS has returned from a low battery.
2017/06/27 18:33:51	0955055657	UPS Agent(My Office)<192.168.66.102>:battery are very low.UPS will be shutdown
2017/06/27 18:33:41	0917461725	UPS Agent(My Office)<192.168.66.102>:battery are very low.UPS will be shutdown
2017/06/27 18:33:32	0922725209	UPS Agent(My Office)<192.168.66.102>:battery are very low.UPS will be shutdown
2017/06/27 18:33:23	0955055657	UPS Agent(My Office)<192.168.66.102>:battery are very low.UPS will be shutdown
2017/06/27 18:33:14	0955055657	UPS Agent(My Office)<192.168.66.102>:UPS communication has been established.
2017/06/27 18:33:04	0917461725	UPS Agent(My Office)<192.168.66.102>:UPS communication has been established.
2017/06/27 18:32:55	0922725209	UPS Agent(My Office)<192.168.66.102>:UPS communication has been established.
2017/06/27 18:32:45	0955055657	UPS Agent(My Office)<192.168.66.102>:UPS communication has been established.
2017/06/27 18:28:12	0955055657	TEST

Check event by year/month

Date of SMS 2017/06

Save
Clear...
Help

save.csv file

NetAgent II 3PORTS

- Information
- Configuration
- Log Information
 - Event Log
 - SMS Log**
 - Data Log
 - Battery Test Log
- Help

SMS Log

Date/Time	Mobile Number	SMS Content
2017/06/28 18:57:31	0922725209	UPS Agent(My Office)<192.168.66.102>:UPS communication has been lost. (Send SMS Failed!)
2017/06/28 18:56:10	0917461725	UPS Agent(My Office)<192.168.66.102>:UPS communication has been lost. (Send SMS Failed!)
2017/06/28 18:54:49	0955055657	UPS Agent(My Office)<192.168.66.102>:UPS communication has been lost. (Send SMS Failed!)
2017/06/27 19:13:42	0922725209	UPS Agent(My Office)<192.168.66.103>:Utility power has been restored.
2017/06/27 19:13:09	0917461725	UPS Agent(My Office)<192.168.66.103>:Utility power has been restored.
2017/06/27 19:12:36	0955055657	UPS Agent(My Office)<192.168.66.103>:Utility power has been restored.
2017/06/27 19:12:03	0922725209	UPS Agent(My Office)<192.168.66.103>:UPS has switched to battery power.
2017/06/27 19:11:30	0917461725	UPS Agent(My Office)<192.168.66.103>:UPS has switched to battery power.
2017/06/27 19:10:57	0955055657	UPS Agent(My Office)<192.168.66.103>:UPS has switched to battery power.

Clear
Help

108

■ Log Information > Data Log

It records UPS Input Voltage/Output Voltage/ Frequency/ Loading/Capacity/ Temperature. When connects with NetFeeler, temperature, humidity will also be recorded. Log capacity is 5000 logs. When reach to the limit, it rewrites on the previous logs. Logs can be saved in CSV format by clicking on “Save Data Log”.

csv file name as below

NetAgent 9 → datalog_year/month.csv , e.g.:datalog_201706

NetAgent II → upsdata.cs

NetAgent 9 Mini & NetAgent 9

Log Information > Data Log

Page number

1 2 3 4 5 6 7 8 9 10 11 12 13 14 15 16 17 18 19 20 Next

Date/Time	Input Volt.(V)	Output Volt.(V)	Freq. (Hz)	Load(%)	Capacity(%)	Battery Volt.(V)	Cell Volt.(V)	Temp.	Env. Temp.	Env. Humidity
2017/06/25 22:39:38	220.1	220.1	50.0	10	100	325.20	27.10	30.1°C 86.1°F	32.5°C 90.5°F	71
2017/06/25 22:38:37	220.1	220.1	50.0	10	100	325.20	27.10	30.1°C 86.1°F	32.5°C 90.5°F	70
2017/06/25 22:37:36	220.1	220.1	50.0	10	100	325.20	27.10	30.1°C 86.1°F	33.0°C 91.4°F	69
2017/06/25 22:36:35	220.1	220.1	50.0	10	100	325.20	27.10	30.1°C 86.1°F	33.5°C 92.3°F	68
2017/06/25 22:35:34	220.1	220.1	50.0	10	100	325.20	27.10	30.1°C 86.1°F	33.5°C 92.3°F	68
2017/06/25 22:34:33	220.1	220.1	50.0	10	100	325.20	27.10	30.1°C 86.1°F	33.5°C 92.3°F	68
2017/06/25 22:33:32	220.1	220.1	50.0	100	100	325.20	27.10	30.1°C 86.1°F	33.5°C 92.3°F	68
2017/06/25 22:27:43	220.1	220.1	50.0	100	100	325.20	27.10	30.1°C 86.1°F	32.5°C 90.5°F	71
2017/06/25 22:26:24	220.1	220.1	50.0	10	100	325.20	27.10	30.1°C 86.1°F	33.0°C 91.4°F	71
2017/06/25 22:25:23	220.1	220.1	50.0	10	100	325.20	27.10	30.1°C 86.1°F	33.0°C 91.4°F	68
2017/06/25 22:24:21	220.1	220.1	50.0	10	100	325.20	27.10	30.1°C 86.1°F	33.0°C 91.4°F	68

Date of Datalog: 2017/06/25

Save Data Log Clear... Help

Check event by year/month

save csv.file

Log Information > Data Log

Data Log

- datalog_20170624.dat
- datalog_20170625.dat
- datalog_20170626.dat
- datalog_20170627.dat
- datalog_20170727.dat
- datalog_20170827.dat

1. Select dat. file to delete

2. Delete

Select All Clear All Delete

NetAgent Mini & NetAgent II

NetAgent
Data Log

Information									
Configuration									
Log Information									
Event Log									
Data Log									
Battery Test Log									
Help									
	Date/Time	Input Volt.	Output Volt.	Freq. (Hz)	Load	Capacity	Temp.	Env. Temp.	Env. Humidity
	2017/06/27 19:30:00	220.1	220.1	50.0	10	100	30.1°C 86.1°F	26.4°C 79.5°F	59
	2017/06/27 19:29:00	220.1	220.1	50.0	10	100	30.1°C 86.1°F	26.4°C 79.5°F	59
	2017/06/27 19:27:59	220.1	220.1	50.0	10	100	30.1°C 86.1°F	25.9°C 78.6°F	60
	2017/06/27 19:26:58	220.1	220.1	50.0	10	100	30.1°C 86.1°F	25.9°C 78.6°F	60
	2017/06/27 19:25:57	220.1	220.1	50.0	10	100	30.1°C 86.1°F	25.9°C 78.6°F	59
	2017/06/27 19:24:57	220.1	220.1	50.0	10	100	30.1°C 86.1°F	25.9°C 78.6°F	58
	2017/06/27 19:23:56	220.1	220.1	50.0	10	100	30.1°C 86.1°F	25.9°C 78.6°F	59
	2017/06/27 19:10:23	220.1	220.1	50.0	10	100	30.1°C 86.1°F	26.4°C 79.5°F	59

Clear Save Data Log Help

■ **Log Information > Battery Test Log**

To record the UPS Self-Test and it shows in graphic. UPS Self-Test option is available under System Information > Remote Contro.

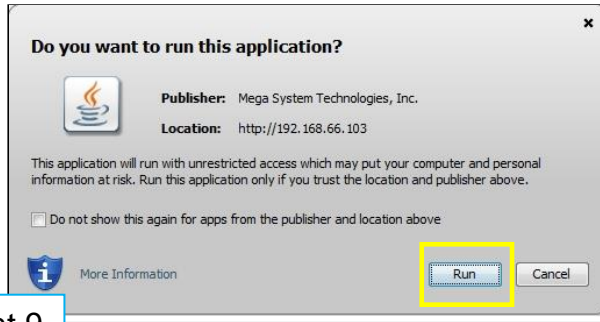

NetAgent 9 Mini & NetAgent 9

Information Configuration Log Information Event Log Data Log Battery Test Log Help

Log Information > Battery Test Log

Battery Test Log

Battery Testing Start Date/Time	Battery Testing Duration	Operation
2017/06/27 08:23:01	00:04:49	Save Delete
2017/06/27 16:32:46	00:09:46	Save Delete

Refresh Help

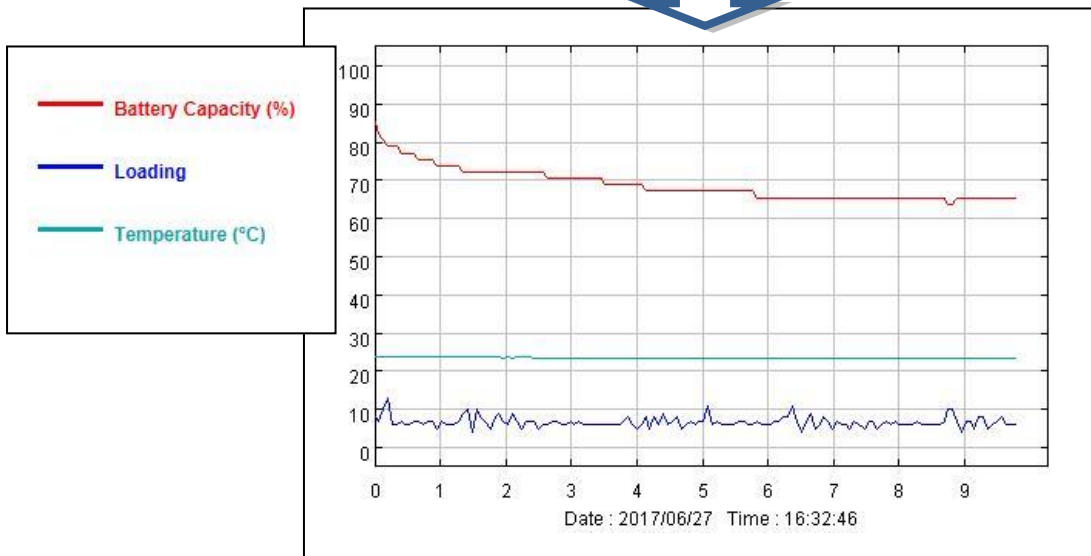

Information System Status Basic Information Current Status Remote Control Meter/Chart SMS Modem Status NetSwitch Status

Information > Remote Control

UPS Testing

- 10-Second Test
- Deep Battery Test for 10 minute(s)
- Test until battery capacity below 10 %
- Test Until Battery Low
- Cancel Test

NetAgent Mini & NetAgent II



NetAgent Remote Control

UPS Testing

- 10-Second Test
- Deep Battery Test for minute(s)
- Test until battery capacity below %
- Test Until Battery Low
- Cancel Test

■ Help > Search NetAgent

This to display all the found NetAgent within network with its serial number; Mac Address; Hardware/Firmware version and its IP address. Double click on the highlighted unit to open the webpage of such device.

NetAgent 9 Mini & NetAgent 9

The screenshot shows the 'Help > Search NetAgent' interface. On the left is a navigation menu with 'Information', 'Configuration', 'Log Information', and 'Help'. Under 'Help', there are links for 'Search NetAgent', 'Serial Port Debug', 'Help', and 'About'. The main content area displays a table titled 'Search NetAgent' with the following data:

Device	MAC Address	Hardware	Firmware	IP Address
3926404591	00:03:EA:08:2D:EF	HBT506	2.48.BT506.EAST	192.168.66.102
3927177694	00:03:EA:13:F9:DE	HDY520	3.5.DY520.a	192.168.66.104

Below the table are 'Refresh' and 'Help' buttons. A mouse cursor is hovering over the 'HDY520' hardware entry in the second row.

NetAgent Mini & NetAgent II

The screenshot shows the 'NetAgent' interface with a 'Browse NetAgent' header. On the left is a navigation menu with 'Information', 'Configuration', 'Log Information', and 'Help'. Under 'Help', there are links for 'Search NetAgent', 'Serial Port Debug', 'Help', and 'About'. The main content area displays a table with the following data:

Device	MAC Address	Hardware	Firmware	IP Address
3927177694	00:03:EA:13:F9:DE	HDY520	3.5.DY520.a	192.168.66.104
3927225097	00:03:EA:14:B3:09	HBY506	3.5.BY506	192.168.66.103

Below the table are 'Refresh' and 'Help' buttons. A mouse cursor is hovering over the 'HBY506' hardware entry in the second row.

■ Help > Serial Port Debug

It shows the communication status between NetAgent and UPS by Sent and Received columns. Command can send automatically by NetAgent, or manually enter the command to UPS. (Java is required)

Port Information

This is to configure the communication parameter between NetAgent and UPS. Parameters are Debug Mode; Port; Speed (Baud), Data Bits;Parity and Stop Bits. Two encoding formats: ASCII or Hexadecimal.

If Debug mode is set as manually, user may enter its parameter under Send Contents column.

Sent Information

This column shows the real time sent command

Received Information

This display the response that NetAgent receives from UPS

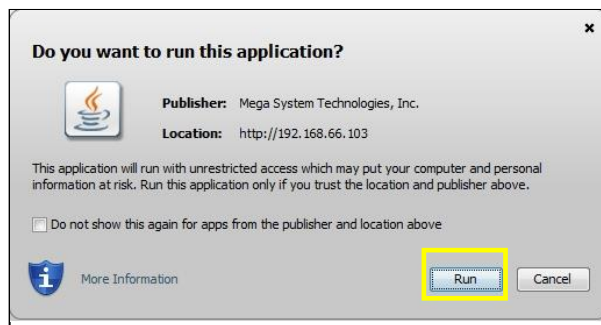

NetAgent 9 Mini & NetAgent 9



Help > Serial Port Debug

Port Information | **Debug Information**

ASCII Hexadecimal

Send Content:

Buttons: **Send**, **Clear**

Sent Information

```

PM 06:09:58: Q1r
PM 06:09:58: lr
PM 06:09:58: Fr
PM 06:10:01: Q1r
PM 06:10:01: lr
PM 06:10:01: Fr
PM 06:10:01: Q1r
PM 06:10:03: lr
PM 06:10:03: Fr
PM 06:10:03: Q1r
PM 06:10:05: lr
PM 06:10:05: Fr
PM 06:10:05: Q1r

```

Buttons: **Clear**

Received Information

```

PM 06:09:29: #110.0 009 036.0 60.0r
PM 06:09:29: (109.6 109.4 109.9 006 60.0 2.27 22.9 00000001r
PM 06:09:29: # LV 1K 00019.12 lr
PM 06:09:29: #110.0 009 036.0 60.0r
PM 06:09:29: (109.4 109.3 110.1 006 60.0 2.27 22.9 00000001r
PM 06:09:29: # LV 1K 00019.12 lr
PM 06:09:29: #110.0 009 036.0 60.0r
PM 06:09:29: (109.0 109.2 109.4 006 60.0 2.27 22.9 00000001r
PM 06:09:29: # LV 1K 00019.12 lr
PM 06:09:29: #110.0 009 036.0 60.0r
PM 06:09:29: (109.3 108.9 109.8 005 60.0 2.27 22.9 00000001r
PM 06:09:29: # LV 1K 00019.12 lr
PM 06:09:29: #110.0 009 036.0 60.0r

```

Annotations: "Send command Manually" with arrows pointing to the Send Content field and the Send button.

NetAgent Mini & NetAgent II

NetAgent | Serial Ports Debug

Port Information

Debug Mode: Auto | Port: UPS

Speed(baud): 2400 | Data Bits: 8

Parity: None | Stop Bits: 1 Bit

Buttons: **Apply**, **Help**

ASCII Hexadecimal

Send Content:

Buttons: **Send**, **Clear**

Sent Information

```

PM 05:57:09: lr
PM 05:57:09: Fr
PM 05:57:09: Q1r
PM 05:57:09: lr
PM 05:57:09: Fr
PM 05:57:09: Q1r
PM 05:57:12: lr
PM 05:57:12: Fr
PM 05:57:12: Q1r
PM 05:57:12: lr
PM 05:57:14: Fr
PM 05:57:14: Q1r
PM 05:57:14: lr

```

Buttons: **Clear**

Received Information

```

PM 05:57:52: (107.1 107.4 109.5 005 59.9 2.27 22.9 00000001r
PM 05:57:52: # LV 1K 00019.12 lr
PM 05:57:52: #110.0 009 036.0 60.0r
PM 05:57:52: (107.8 107.3 109.6 005 59.9 2.27 22.9 00000001r
PM 05:57:52: # LV 1K 00019.12 lr
PM 05:57:52: #110.0 009 036.0 60.0r
PM 05:57:52: (107.6 107.2 109.7 006 59.9 2.27 22.9 00000001r
PM 05:57:52: # LV 1K 00019.12 lr
PM 05:57:52: #110.0 009 036.0 60.0r
PM 05:57:55: #110.0 009 036.0 60.0r
PM 05:57:55: (107.3 107.5 109.8 006 59.9 2.27 22.9 00000001r
PM 05:57:55: # LV 1K 00019.12 lr
PM 05:57:55: #110.0 009 036.0 60.0r

```

Annotations: "Send Command Manually" with arrows pointing to the Send Content field and the Send button.

■ Help > Help

This is to help to illustrate each feature/option that NetAgent offers

NetAgent 9 Mini & NetAgent 9

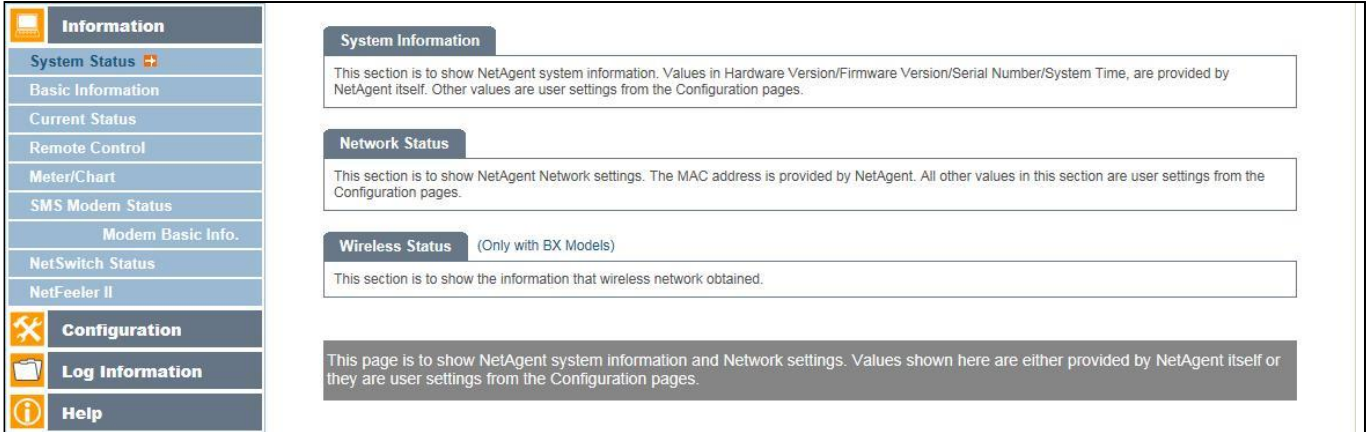

The screenshot shows the help page for NetAgent 9 Mini & NetAgent 9. On the left is a navigation menu with the following items: Information (System Status, Basic Information, Current Status, Remote Control, Meter/Chart, SMS Modem Status, Modem Basic Info., NetSwitch Status, NetFeeler II), Configuration, Log Information, and Help. The main content area is titled 'System Status' and contains three sections: 'System Information' (describing hardware and user settings), 'Network Status' (describing network settings and MAC address), and 'Wireless Status' (noting it is only for BX Models and showing wireless network information). A summary paragraph at the bottom states that the page shows system and network settings provided by NetAgent or user settings.

NetAgent Mini & NetAgent II

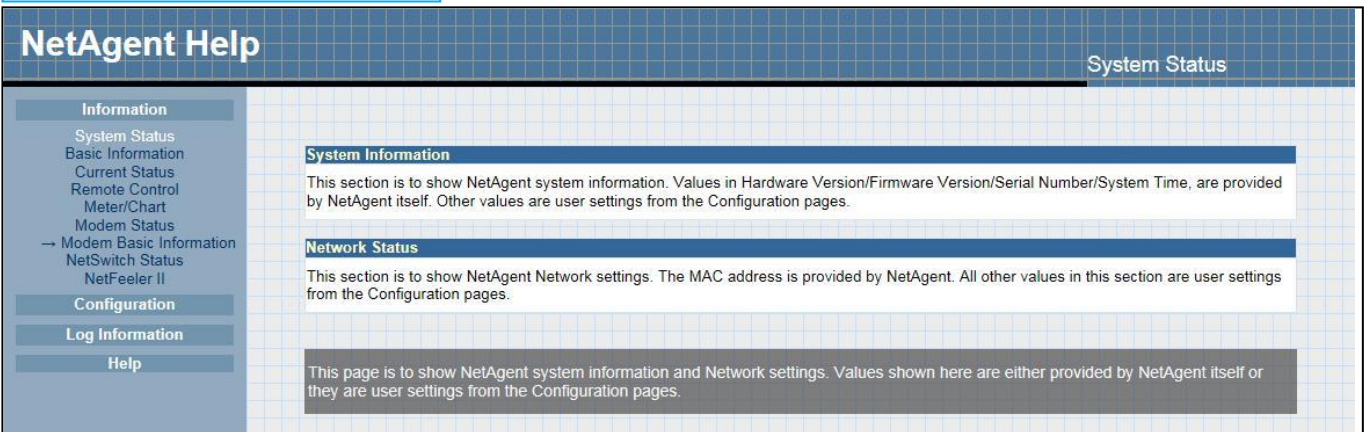

The screenshot shows the help page for NetAgent Mini & NetAgent II. The page has a blue header with 'NetAgent Help' on the left and 'System Status' on the right. The left navigation menu includes: Information (System Status, Basic Information, Current Status, Remote Control, Meter/Chart, Modem Status, Modem Basic Information, NetSwitch Status, NetFeeler II), Configuration, Log Information, and Help. The main content area contains three sections: 'System Information', 'Network Status', and a summary paragraph at the bottom. The text in these sections is identical to the previous screenshot, describing system and network settings.

■ Help > About

About

It shows NetAgent's hardware/firmware and serial number.

Save/Restore Settings

Save Current Configuration

Click on Save to save the configuration to your PC. The text file will have a default format of YYYY_MMDD_####.cfg. Administrator permission required.

Restore previous configuration

Use this function to restore a *.cfg configuration that has been saved earlier. Click Browse... to the location of the file and click **Restore**.

Reset to factory default

This function will reset all settings to its default value.

NetAgent 9 Mini & NetAgent 9

About	
Firmware Version	3.5.BY506
Hardware Version	HBY506
Serial Number	3927225097

Save/Restore Settings

Save current configuration

Restore previous configuration

Reset to factory default

Mega System Technologies, Inc.
Tel:+886-2-87922060 Fax:+886-2-87922066
E-mail:netagent@megatec.com.tw
http://www.megatec.com.tw

Firmware Update Settings

Default FTP server is set as ftp.icv99.com with its username/password. Click on Update Now, NetAgent will connect to the FTP server and upgrade to the latest firmware version accordingly. Or, it could upgrade per preset time

FTP Server:

User:

Password:

Update Now >>

Auto Update: Every At (Hour : Minute)

Update Firmware from FTP Client:

To enable NetAgent's FTP firmware upgrade, please download the appropriate firmware version from the website and upgrade through FTP Client Software.

Mega System Technologies, Inc.
Tel:+886-2-87922060 Fax:+886-2-87922066
E-mail:netagent@megatec.com.tw
http://www.megatec.com.tw

NetAgent Mini & NetAgent II

NetAgent About

Information

Configuration

Log Information

Help
 Search NetAgent
 Serial Port Debug
 Help
 About

About
 Firmware Version: 2.48.BT506.EAST
 Hardware Version: HBT506
 Serial Number: 3926404591

Save/Restore Settings
 Save current configuration
 Restore previous configuration
 Reset to factory default

*: This upload function could not be used in HTTPS mode.

Firmware Update Settings

FTP Server:
 User:
 Password:

Auto Update: Every At (Hour : Minute)

Update Firmware from FTP Client:

*: System will reboot when these items have been Applied.

Mega System Technologies, Inc.
 Tel: +886-2-87922060 Fax: +886-2-87922066
 E-mail: netagent@megatec.com.tw
 http://www.megatec.com.tw

Update Firmware from FTP Client

-Select on Enable

-Download the appropriate firmware version from website
<http://www.megatec.com.tw>

-Unzip the file and know the directory path

► Software Downloads
 ► Technical Support & FAQ
 ► Online Ordering
 ► Shipment Tracking

Please contact the [WebMaster](#) if you find any problems with the download page. This page is best viewed on 1024x768.

NetAgent 9

NetAgent Firmware download procedure:
 1. Check your CURRENT FIRMWARE Version.
 2. Locate your MODEL NUMBER shown at the bottom of your NetAgent device.
 3. Choose the correct firmware version corresponding to your Model Number.

★ Please download the Firmware corresponding to your Model Type from the table below.

Model	NEW Firmware name	Release Date
DY520	3.5.DY520.a.zip	23rd December, 2016
DL520	3.5.DL520.zip	23rd December, 2016
CY504	3.5.CY504.zip	23rd December, 2016
BY506	3.5.BY506.zip	23rd December, 2016
DX520	3.5.DX520.zip	
CX504	3.5.CX504.zip	
BX506	3.5.BX506.zip	

Warning: BX Unit with 3.1 BX506 MI LIST

-Execute ftp + NetAgent's IP address

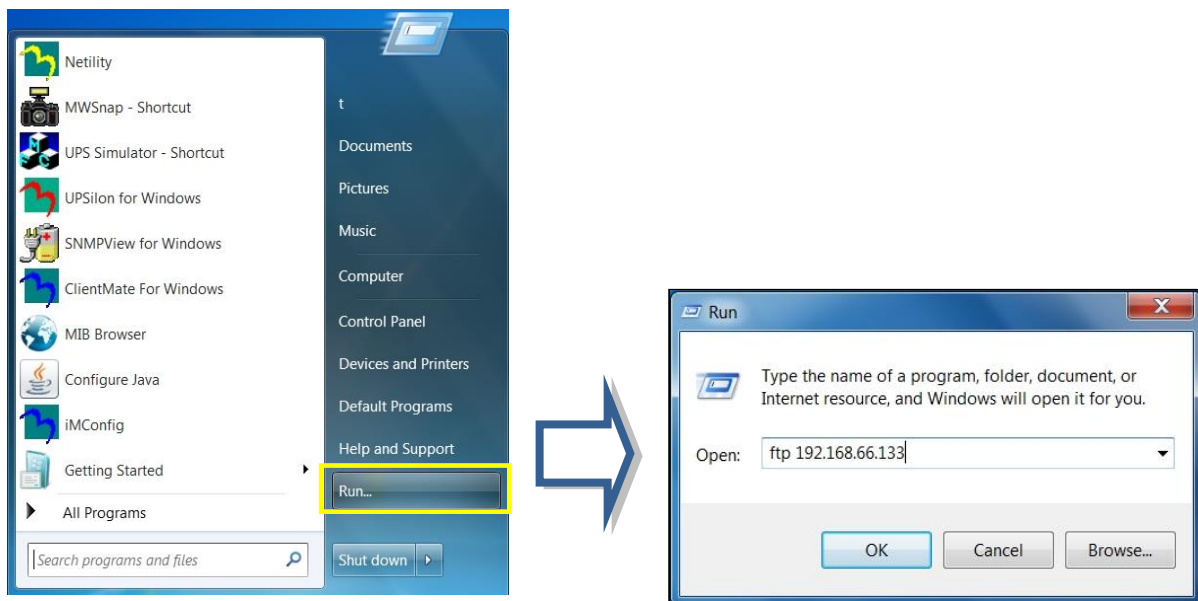

-FTP login

```
Connected to 192.168.66.133.
220 Service ready for new user
User (192.168.66.133:(none)): admin
331 need password
Password:
230 OK
ftp> ls
200 Port command successful.
150 Opening ASCII mode data connection for file list
3.4.BY506.bin
226 Transfer complete.
ftp: 15 bytes received in 0.00Seconds 15000.00Kbytes/sec.
ftp> put d:\fw\3.5.BY506.bin
200 Port command successful.
150 Opening data connection for 3.5.BY506.bin
226 file received ok.
ftp: 7733248 bytes sent in 8.52Seconds 907.87Kbytes/sec.
ftp> quit
```

1. Enter username/password that configured on Netility

2. Enter command ls to show available firmware bin file

3. Enter put command with bin file directory

4. Once complete, enter command quit

Chapter 5. Telnet/ SSH

Despite to login to the NetAgent's webpage, it could also access via Telnet or SSH

- ✳️ Ensure NetAgent port 22 is enabled when using SSH connection and username/password are required.
- ✳️ When using Telnet, port 23 must be enabled

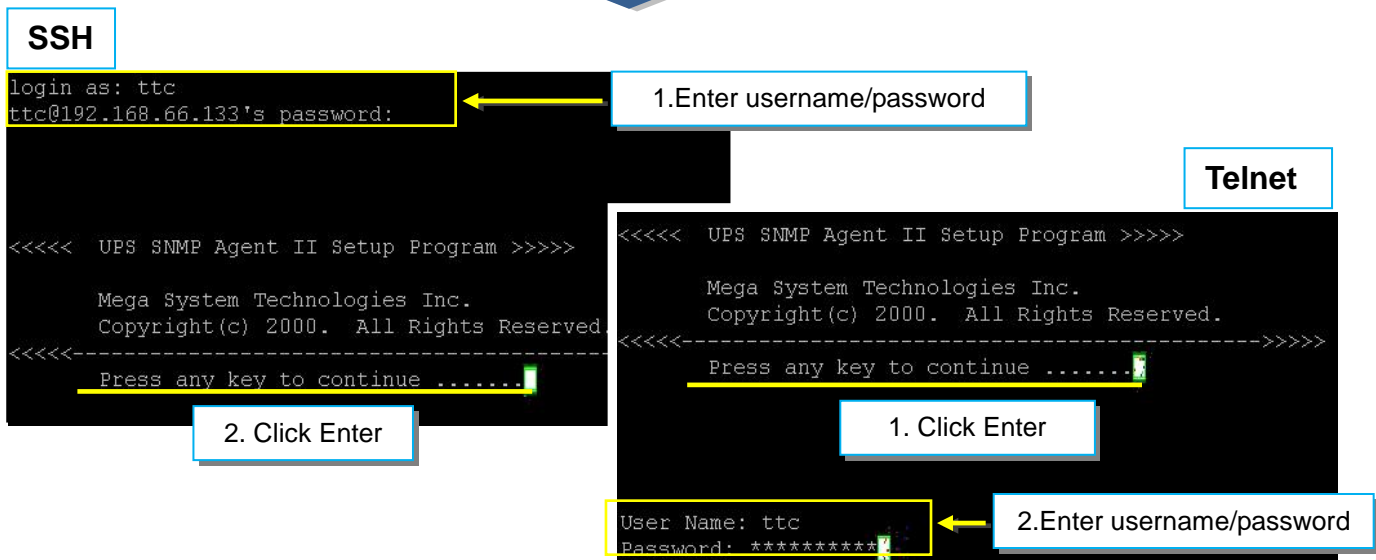
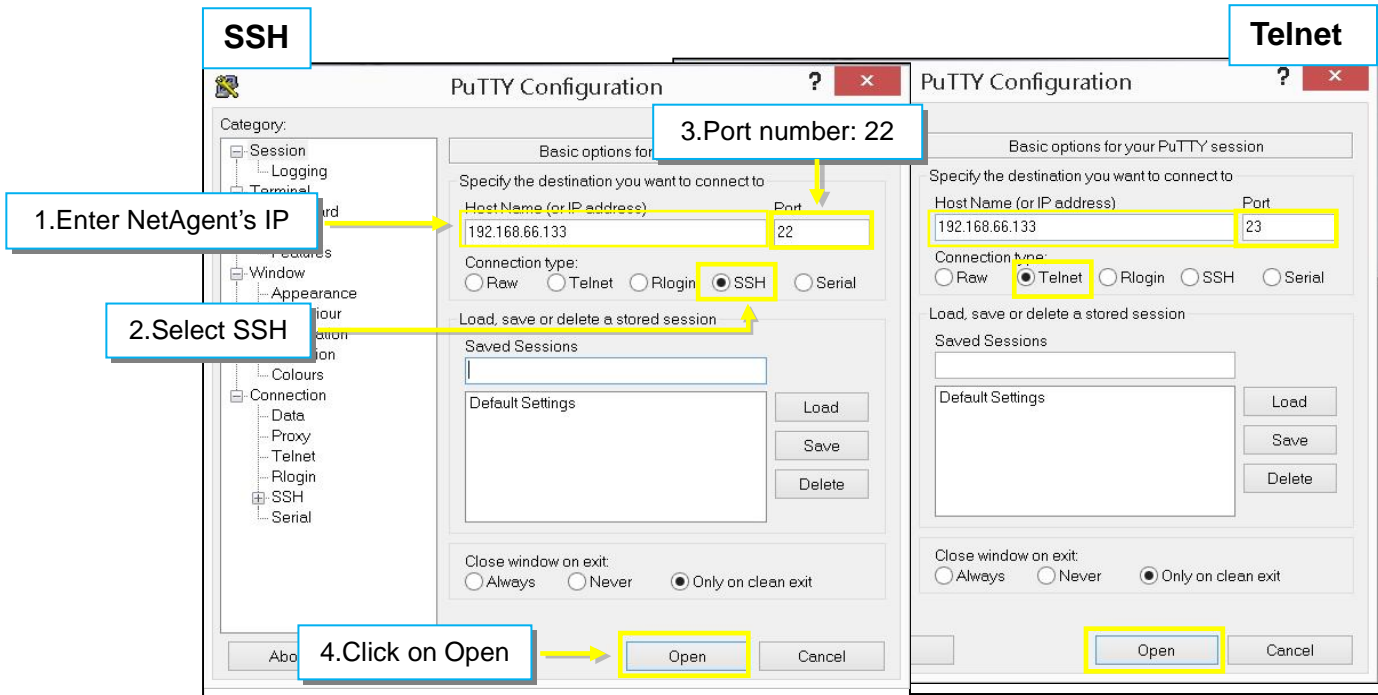

Enter to the Main Menu and enter the number of the option under **Select =>** and press ENTER

```
<<<<<          Main Menu          >>>>>
<----->
1. Set IP Address.
2. Set SNMP MIB System.
3. Set SNMP Access Control.
4. Set SNMP Trap Notification.
5. Set UPS Properties.
6. Set UPS Devices Connected.
7. Set System Time & Time Server.
8. Set Web and Telnet User Account.
9. Set E-mail.
a. Reset Configuration to Default & Reboot
b. Set Environment Group.
c. Save & Reboot.
0. Exit Without Saving.

Select => 1  ← Select
```

1.Set IP Address :

This function allows you to setup IP Address, Gateway Address, Subnet Mask

2.Set SNMP MIB System :

To set the MIB system group parameters.

3.Set SNMP Access Control :

To set the Manager IP, Community, Access Permission.

4.Set SNMP Trap Notification :

To set Trap notification

5.Set UPS Properties :

To setup the Communication Type of UPS, UPS Device Name and Battery Replacement Date.

6.Set UPS Device Connect :

To setup the System Name, Rating which connected., Connected.

7.Set System Time & Time Server :

To setup the System date, time and two time servers.

8.Set Web and Telnet user Account :

This is allows to set users account's authority.

9.Set E-mail :

To set e-mail accounts to receive power event notification for emergency management.

a.Reset configuration to Default & Reboot :

Set all values to their default settings.

b.Set Environment Group :

To set critical value for environmental sensor

c.Save & Reboot :

Save the current configuration data, including any changes you have made, and reboot the Net Agent.

0.Exit Without Saving :

Exit, all configuration changes will be lost

Chapter 6. ClientMate

ClientMate is shutdown software for PC that connects with NetAgent. This utility is for the Windows platform. When the ClientMate gets the power failure signal from the NetAgent. The ClientMate will save the files and shutdown the system gracefully. When the hardware installation of the NetAgent has been completed, install the ClientMate on any of the Windows system on the network. When ClientMate detects AC Fail, Battery Low, Schedule Shutdown signals from the NetAgent, it will save the file and shutdown the system gracefully to avoid system crash.

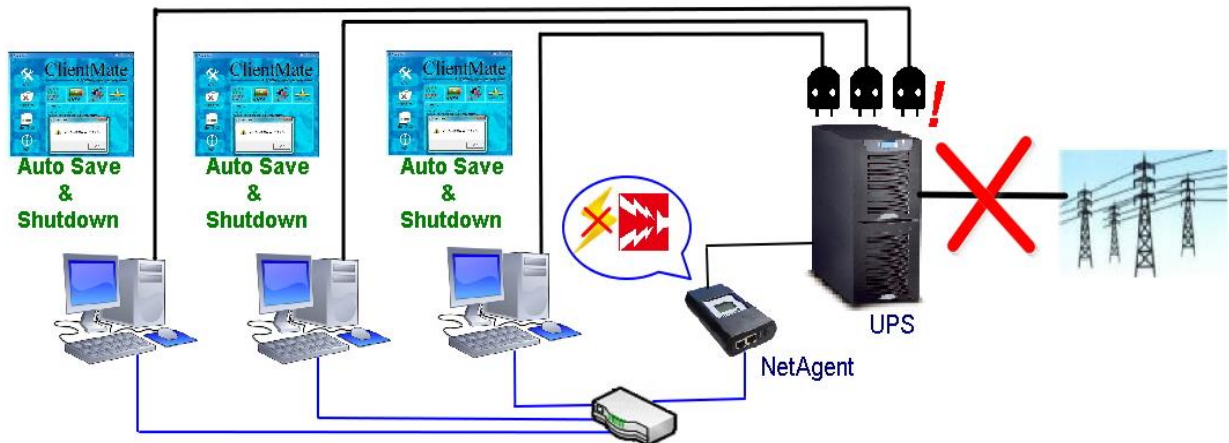

Installation and setup

ClientMate software is available in the CD provided with NetAgent. After installed, it save under directory of

All Program > NetAgent > ClientMate > ClientMate for Windows



Operation Interface

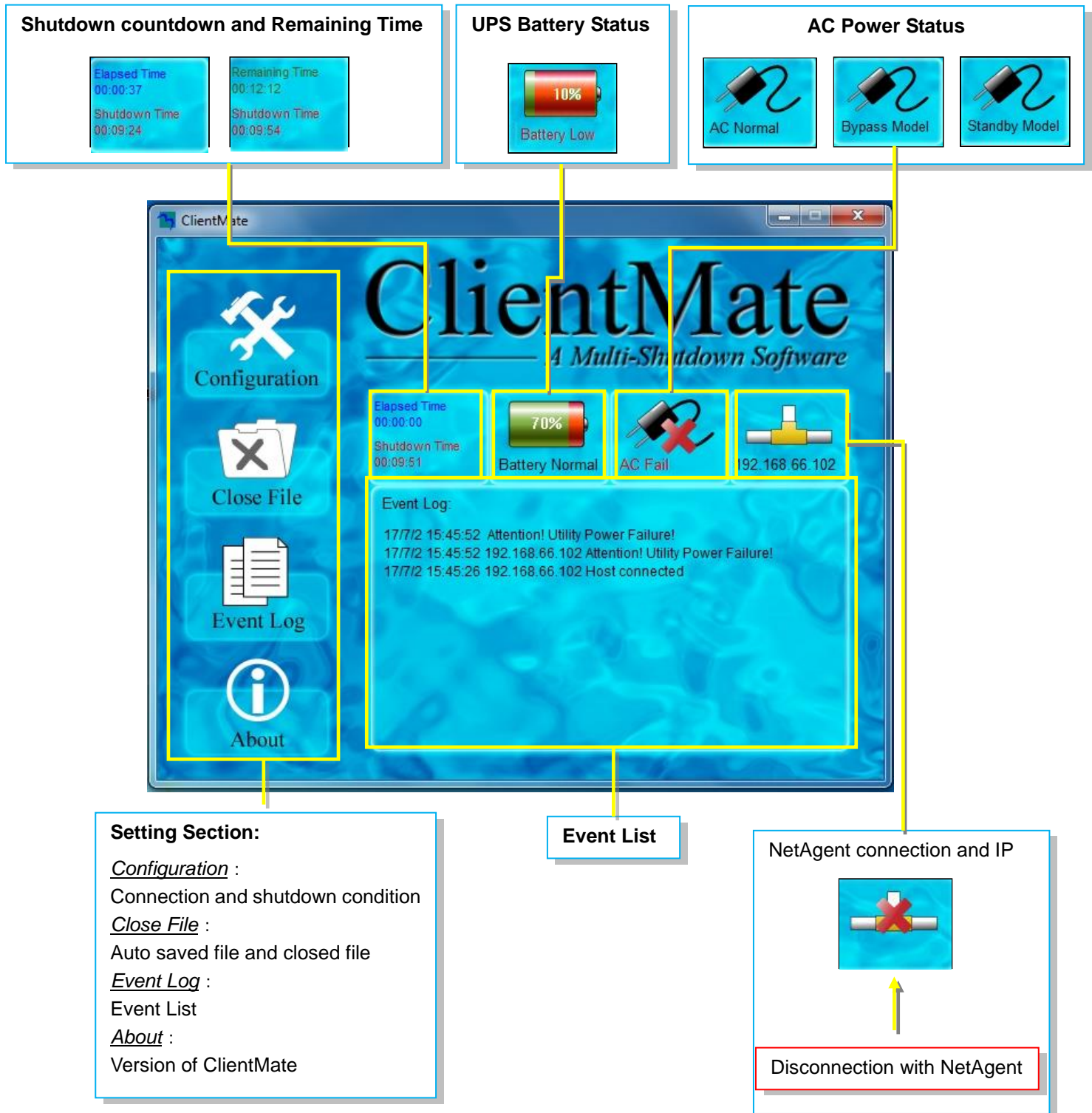

Configuration

The image illustrates the configuration process in ClientMate software. It shows three main windows: the main ClientMate interface, the 'Configure' dialog, and the 'Add' dialog.

ClientMate Main Interface: The 'Configuration' button is highlighted with a yellow box. Other buttons include 'Close File' and 'Event Log'.

Configure Dialog: This dialog has tabs for 'General', 'Power Failure', and 'Schedule Shutdown'. The 'Host Connection' section contains a table with columns 'Host address', 'SNMP Port', and 'Connection Type'. Below the table are 'Add', 'Modify', and 'Remove' buttons. A callout box points to the 'Add' button with the text: "Click Add to add NetAgent device".

Add Dialog: This dialog is used to add a new host connection. It has a 'Host Connection' section with radio buttons for 'SNMP V1/V2', 'SNMP V3', and 'UPSilon/RUPS'. The 'SNMP V1/V2' option is selected. Other fields include 'User Name', 'Password', 'Authenticate' (set to MD5), and 'Privacy' (set to DES). The 'Host' field contains '192.168.66.102' and the 'SNMP port' field contains '161'. A 'Query...' button is present. A callout box points to the 'Host' field with the text: "Enter IP address of NetAgent or UPSilon. Click on Query to show all available NetAgent".

Connection Query Dialog: This dialog shows the results of a query. It has a title bar 'Connection Query' and a list of available connections under the heading 'Available List':
[N] 192.168.66.102
[N] 192.168.66.102
[S] 192.168.66.101
A mouse cursor is pointing at the first entry. A callout box points to the list with the text: "(N) = NetAgent (S) = UPSilon PC".

Additional Callouts: A large blue arrow points from the 'Configuration' button in the main interface to the 'Add' button in the 'Configure' dialog. Another large blue arrow points from the 'Add' dialog to the 'Connection Query' dialog.

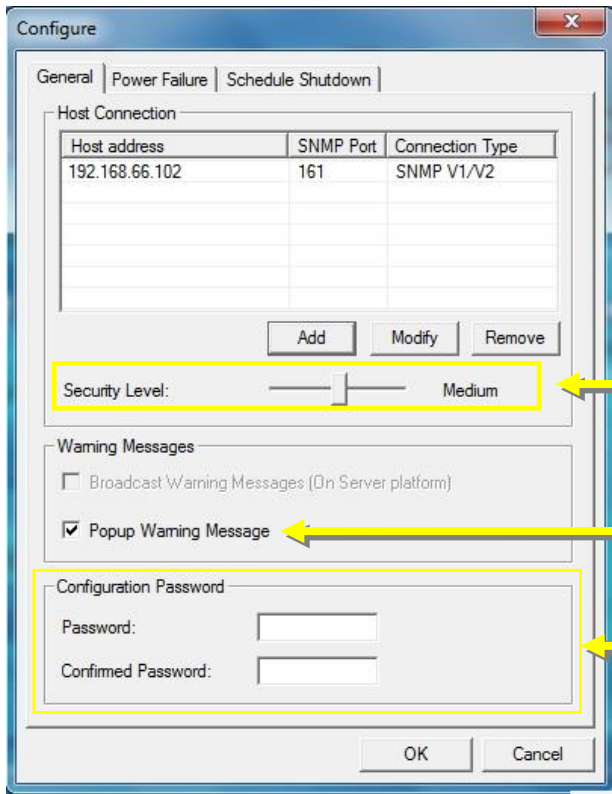

If connect with multi NetAgent, shutdown condition can be perform by security level.
 Low : All NetAgent with AC failure condition
 Medium : 50% NetAgent device has AC failure condition
 High : AC failure from any/single NetAgent would shutdown

If to have pop warning message

If password is required for any configuration change

Power Failure/Shutdown Condition

Shutdown by Scheduling

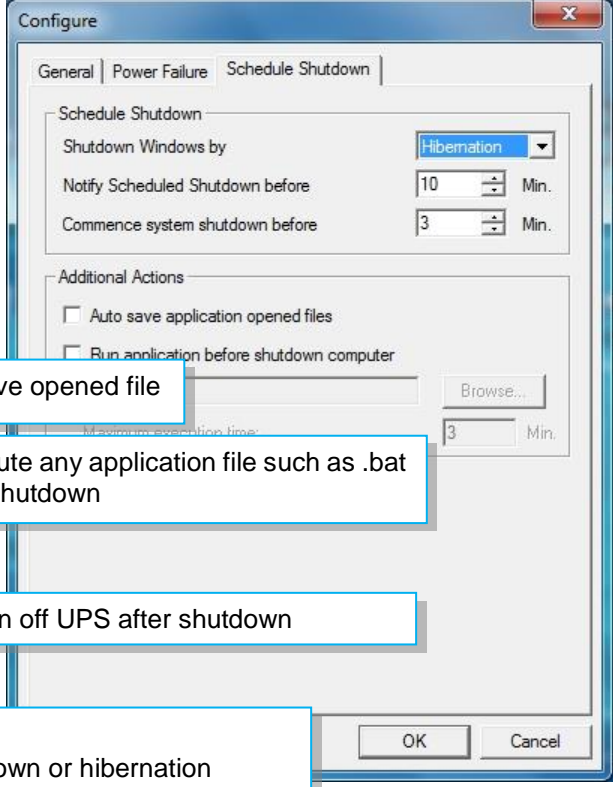
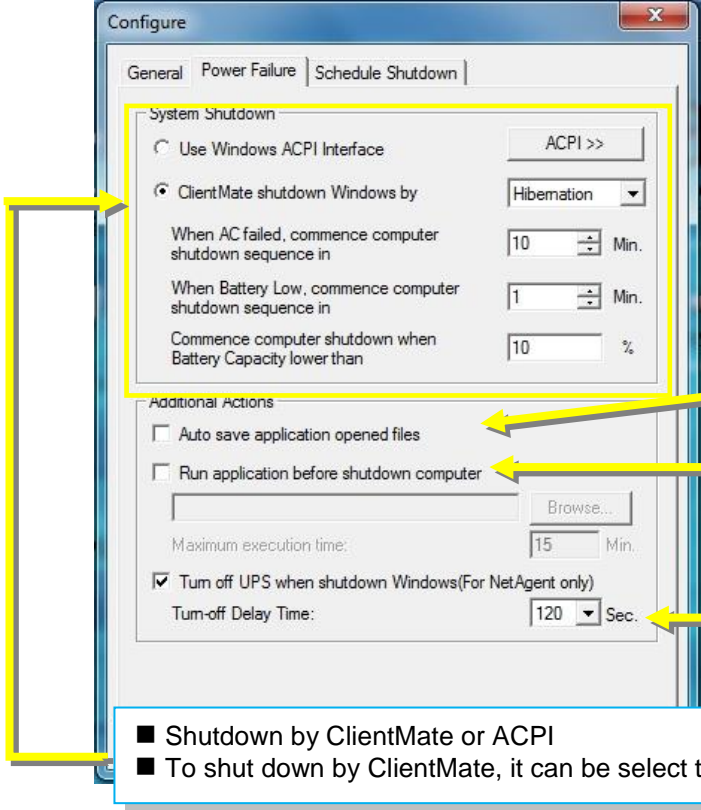

Auto save opened file

To execute any application file such as .bat before shutdown

To turn off UPS after shutdown

- Shutdown by ClientMate or ACPI
- To shut down by ClientMate, it can be select to be shut down or hibernation

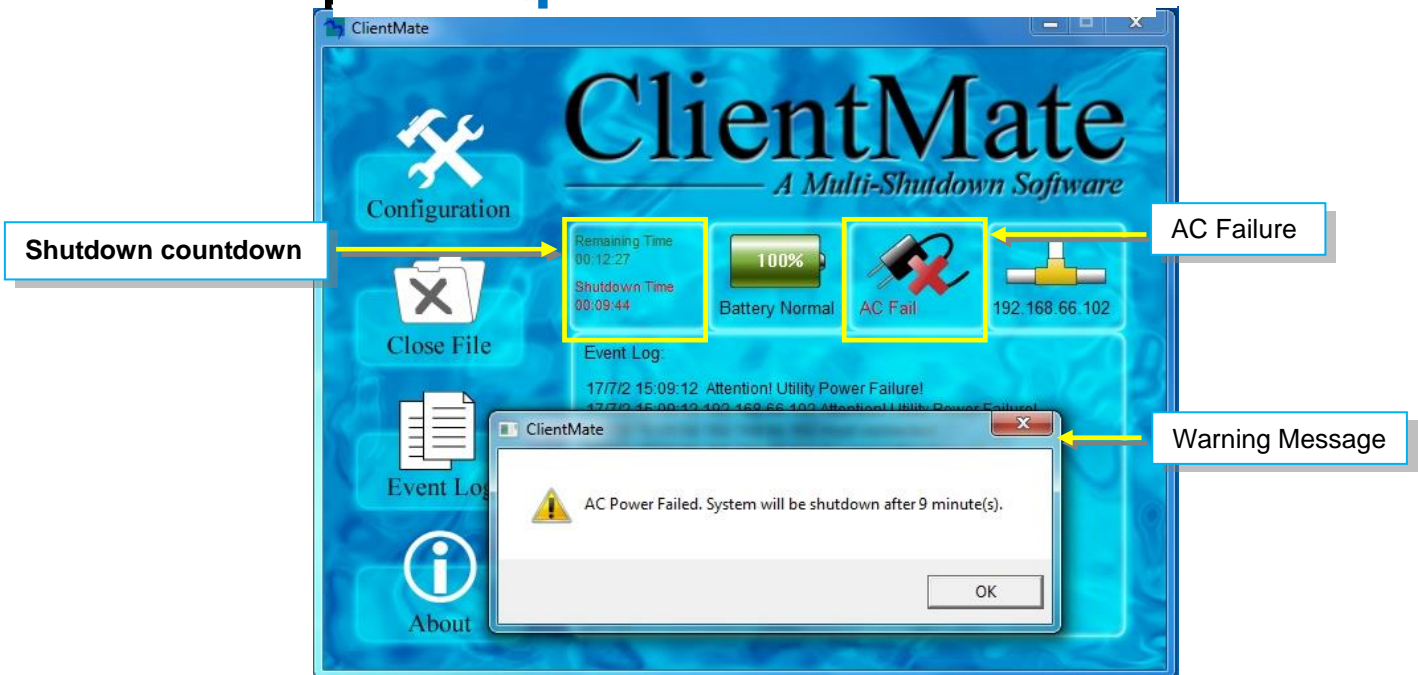
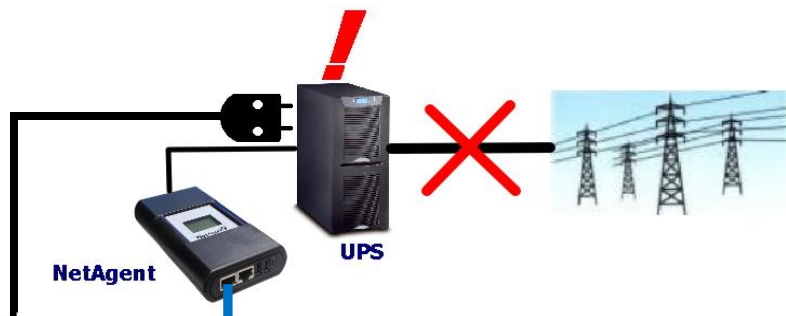
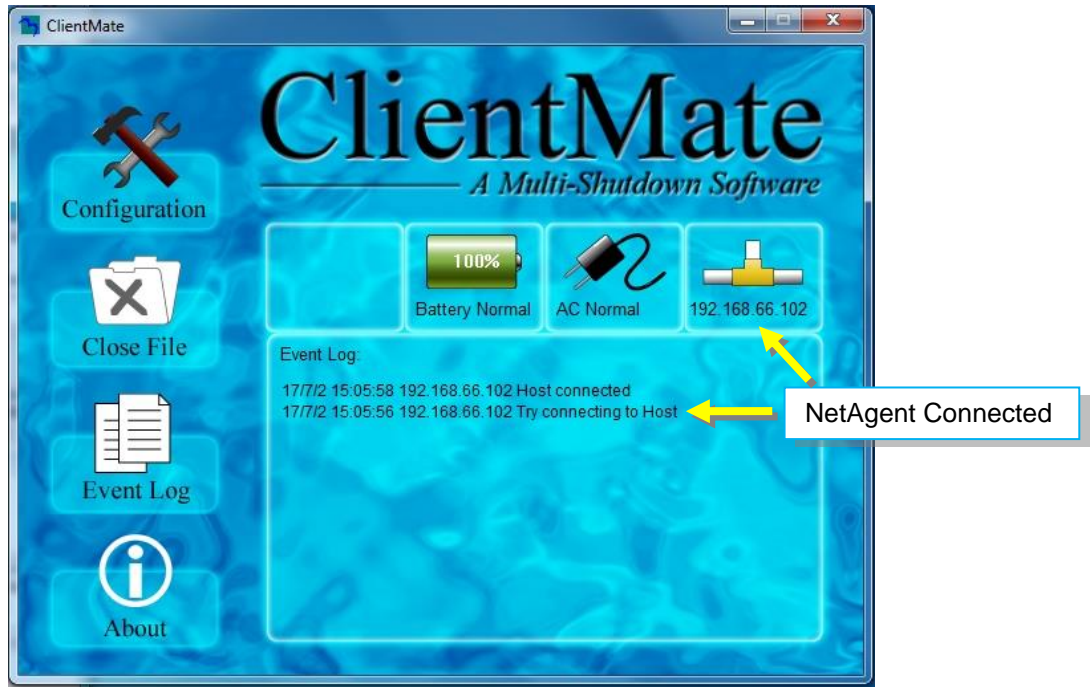

Close File

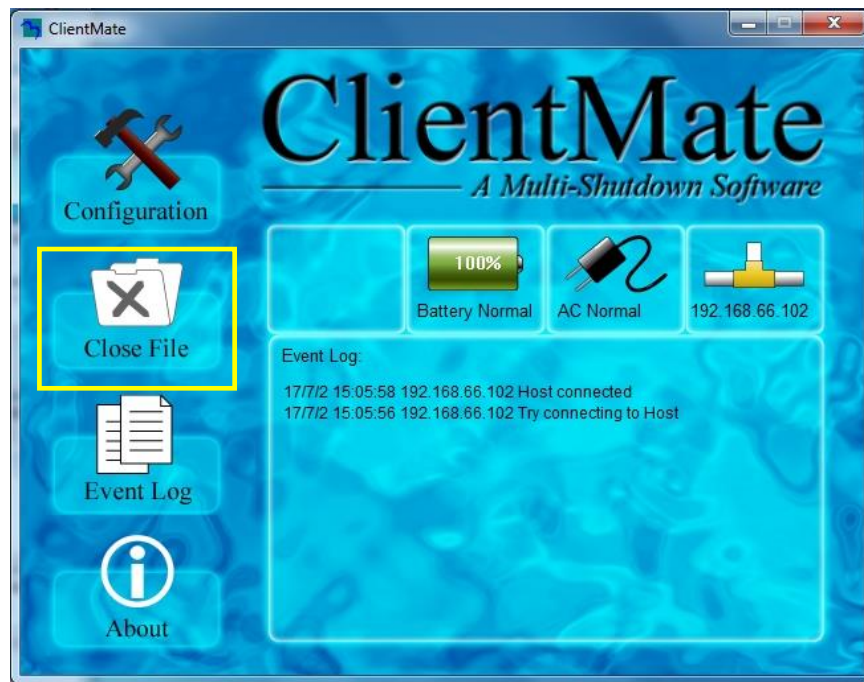

If select to auto save file before shutdown, ClientMate will save the file and file can be check from Closed File

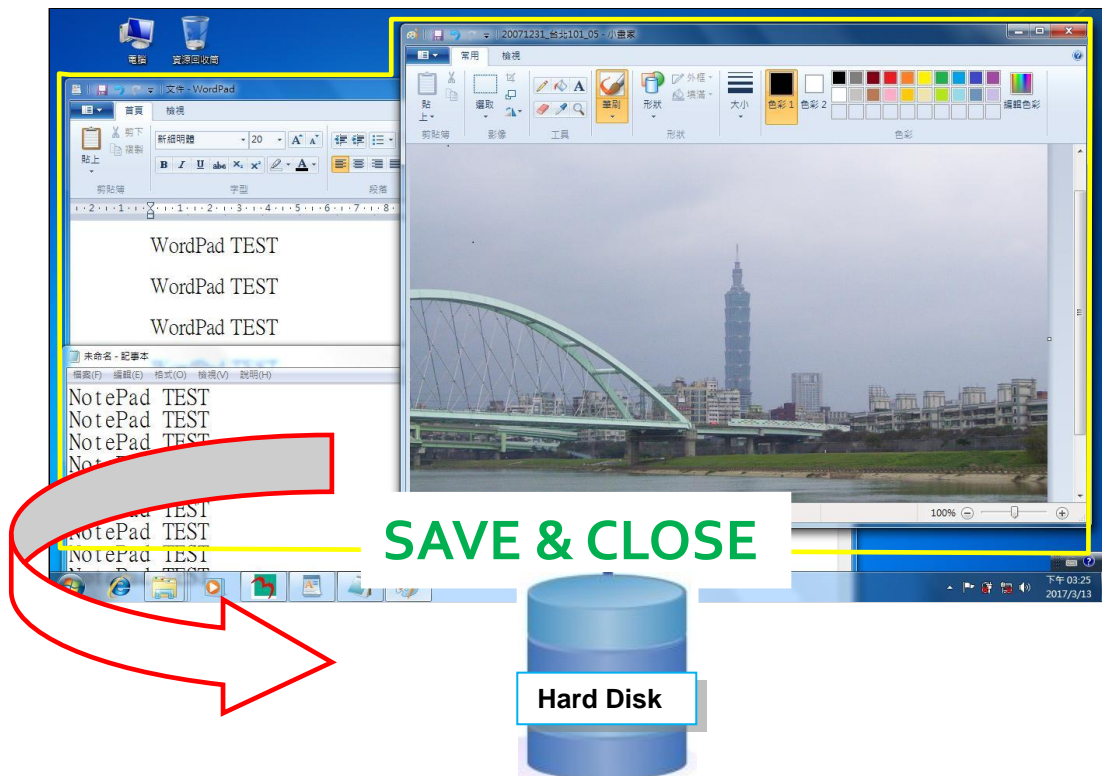

Closed Application or Files Saved As

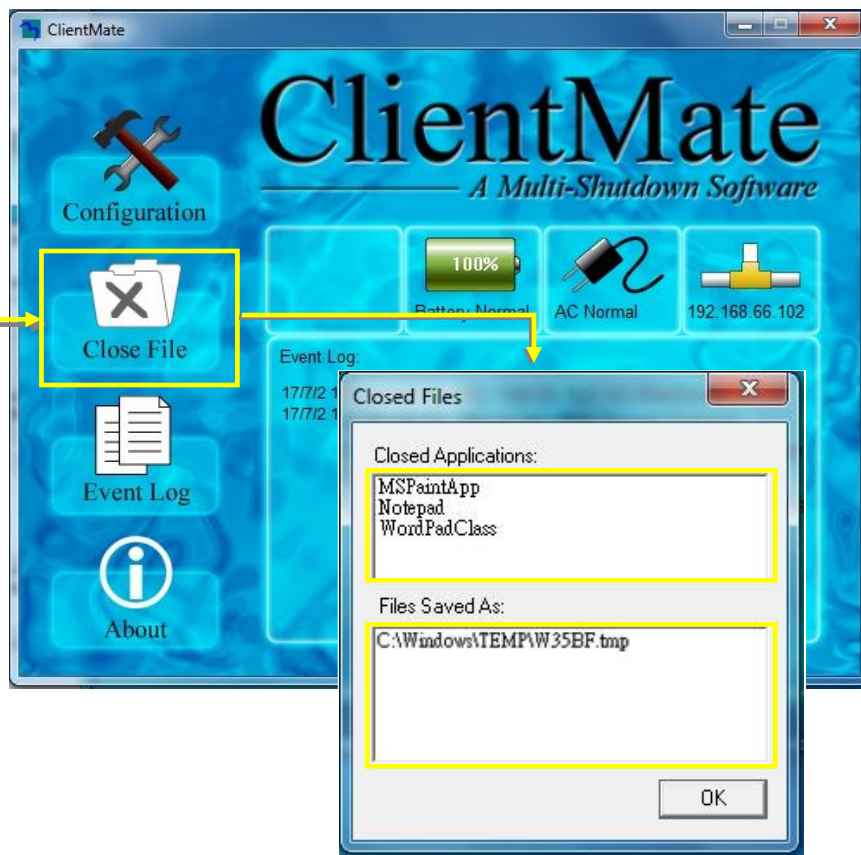

Event Log

The screenshot shows the ClientMate software interface. On the left sidebar, the 'Event Log' button is highlighted with a yellow box. A callout box labeled 'Check Event log' has an arrow pointing to this button. Another yellow arrow points from the 'Event Log' button to the 'Event Log' window that is open in the foreground. The main interface displays the 'ClientMate' logo and 'A Multi-Shutdown Software' tagline. Below the logo, there are status indicators for 'Battery Normal' (100%), 'AC Normal', and the IP address '192.168.66.102'. The 'Event Log' section in the main interface shows two entries: '17/7/2 15:05:58 192.168.66.102 Host connected' and '17/7/2 15:05:56 192.168.66.102 Try connecting to Host'. The 'Event Log' window displays a table with the following data:

Date	Time	Host address	Description
2017/07/02	15:17:06		Attention! Utility Power Fe
2017/07/02	15:17:03	192.168.66.102	Attention! Utility Power Fe
2017/07/02	15:13:03		Battery Restored
2017/07/02	15:13:00	192.168.66.102	Battery Restored
2017/07/02	15:11:41		Attention! UPS Battery Lc
2017/07/02	15:11:38	192.168.66.102	Attention! UPS Battery Lc
2017/07/02	15:10:19		AC Restored
2017/07/02	15:10:16	192.168.66.102	AC Restored
2017/07/02	15:09:12		Attention! Utility Power Fe
2017/07/02	15:09:12	192.168.66.102	Attention! Utility Power Fe
2017/07/02	15:05:58	192.168.66.102	Host connected
2017/07/02	15:05:56	192.168.66.102	Try connecting to Host

About

The screenshot shows the ClientMate software interface. On the left sidebar, the 'About' button is highlighted with a yellow box. A callout box labeled 'Check ClientMate version' has an arrow pointing to this button. Another yellow arrow points from the 'About' button to the '關於' dialog box that is open in the foreground. The main interface displays the 'ClientMate' logo and 'A Multi-Shutdown Software' tagline. Below the logo, there are status indicators for 'Battery Normal' (100%), 'AC Normal', and the IP address '192.168.66.102'. The 'Event Log' section in the main interface shows two entries: '17/7/2 15:05:58 192.168.66.102 Host connected' and '17/7/2 15:05:56 192.168.66.102 Try connecting to Host'. The '關於' dialog box displays the following information:

ClientMate 版本 5.62
Mega System Technologies, Inc.
版權 (C) 2012

Chapter 7. SNMP View

SNMPView is a NMS software to remotely monitor and control multiple UPS with NetAgent.. When an event occurs, SNMPView can be programmed to send an email or trap to inform the designated network manager. It can also inform the user of the UPS current condition or configuration, perform self-test, send a history file, turn the UPS On/Off and more.

Installation and setup

SNMP View software is available in the CD provided with NetAgent. After installed, it saves under directory of

All Programs >NetAgent > SNMPView > SNMP for Windows

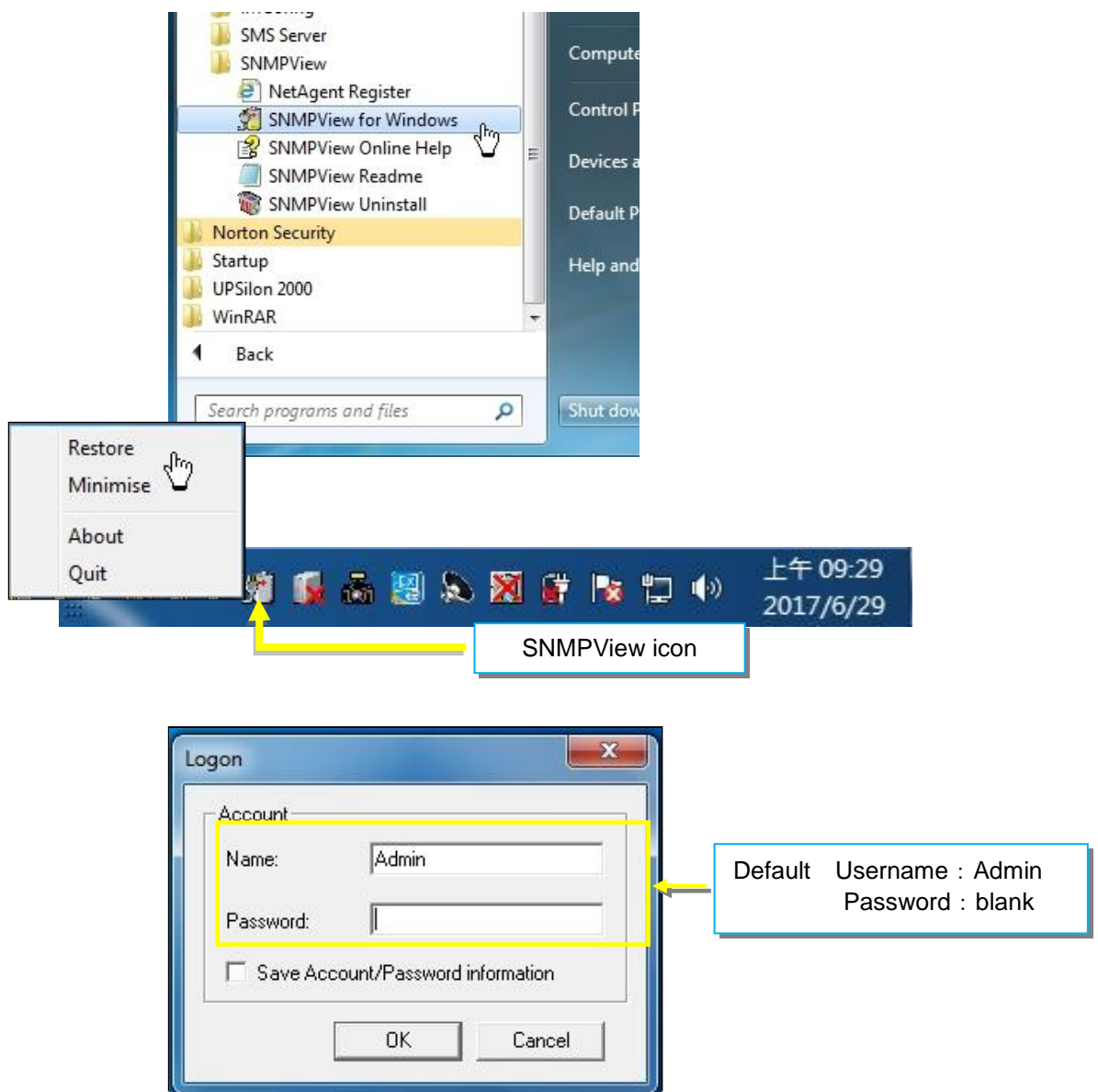

Operation Interface

Setting Section

Group	UPS	Host Name	Location	Output Status	Connection Status	Temperature	Loading	Output Volta...	Capacity	AC Status	Battery Status	NetFeeler II	Manager
NetAgent	192.168.66.102	BT506	2F	AC mode	Connection Normal	30.1	10.0	220.1	100%	AC Normal	Battery Normal	Have	Administrator
2F Control room	192.168.66.103	BY506	2F	AC mode	Connection Normal	30.1	10.0	220.1	100%	AC Normal	Battery Normal	Have	Administrator
3F IDC	192.168.66.101	DY520	Off-Line	Off-Line	Off-Line	Off-Line	Off-Line	Off-Line	Off-Line	Off-Line	Off-Line	Off-Line	Off-Line
6F IDC													
NetProbe													

User: Admin. Location:2F Control room 0 UPS,0 UPS group has been selected | 3 UPS in the list.1 UPS lost communication. | 14:48:38

Group Station

Connection Information

NetAgent and UPS Info

NetAgent Info

UPS connection status and information

NetFeeler Status

UPS	Host Name	Location	Output Status	Connection Status	Temperature	Loading	Output Voltage	Capacity	AC Status	Battery Status	NetFeeler II	Manager
192.168.66.102	BT506	2F	AC mode	Connection Normal	30.1	10.0	220.1	100%	AC Normal	Battery Normal	Have	Administrator
192.168.66.103	BY506	2F	AC mode	Connection Normal	30.1	10.0	220.1	100%	AC Normal	Battery Normal	Have	Administrator
192.168.66.101	DY520	Off-Line	Off-Line	Off-Line	Off-Line	Off-Line	Off-Line	Off-Line	Off-Line	Off-Line	Off-Line	Off-Line

Disconnection between NetAgent and UPS

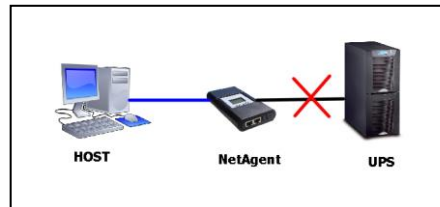

	Connection normal with NetAgent
	Disconnect with NetAgent
	AC Failed
	UPS battery low
	Bypass mode

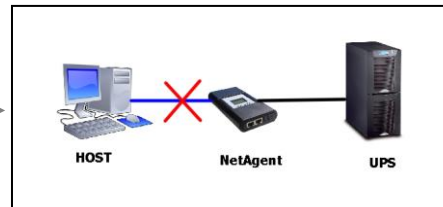

Setting Tab/Device

Device	
Enumerate	F5
Add Group...	F6
Add UPS...	Ins
Delete...	Del
Browse...	
Export Configurations...	
Import Configurations...	
Open archive Event Log...	
Open archive Data Log...	
Quit	

Auto search Online NetAgent
Add NetAgent into Group
Add NetAgent
Delete NetAgent
Browse NetAgent
Export NetAgent Configuration
Import NetAgent Configuration
Open NetAgent SnmpElog.dat
Open NetAgent SnmpDlog.dat

Data Log

UPS Data | Environment Data

UPS	Host Name	Startup Time...	Input Vo...	Output	Battery	Capacity	Loading	Temper...
192.168.0.132	BT506-Smart	2017/6/28 17...	220.1	220.1	27.1	100.0	10.0	30.1
192.168.0.148	UPS Agent S...	2017/6/28 17...	104.1	110.0	2.1	100.0	33.0	31.2
192.168.0.31	BT506-Smart	2017/6/28 17...	103.3	109.7	2.2	100.0	5.0	22.0
192.168.0.32	NETPROBE.N...	2017/6/28 17...	23.77/60	0.00/50	0/80/Hu...	0.00/0...	0.00/0...	
192.168.0.30	NetProbe Mtr...	2017/6/28 17...	Min	25.47/61	10.00/1...	10/100...	0.00/0...	
192.168.0.29	DY520-Smart	2017/6/28 17...	220.1	220.1	27.1	100.0	10.0	30.1
192.168.0.198	inone1-Smart	2017/6/28 17...	208.4	208.6	2.0	63.0	34.0	35.0
192.168.0.175	BT506-Smart	2017/6/28 17...	220.1	220.1	27.1	100.0	10.0	30.1
192.168.0.229	UPS Agent S...	2017/6/28 17...	208.4	208.4	21.5	100.0	10.0	35.0
192.168.0.211	BT506-Smart	2017/6/28 17...	109.3	109.8	2.2	100.0	10.0	22.0
192.168.0.212	NETPROBE.N...	2017/6/28 17...	23.38/59	0.00/50	0/80/Hu...	0.00/0...	0.00/0...	
192.168.0.115	NetProbe Mtr...	2017/6/28 17...	Min	25.00/61	10.00/1...	10/100...	0.00/0...	0.00/0...
192.168.0.212	DY520-Smart	2017/6/28 17...	220.1	220.1	27.1	100.0	10.0	30.1
192.168.0.148	inone1-Smart	2017/6/28 17...	208.4	208.6	2.0	63.0	34.0	35.0
192.168.0.148	BT506-Smart	2017/6/28 17...	220.1	220.1	27.1	100.0	10.0	30.1
192.168.0.148	UPS Agent S...	2017/6/28 17...	208.4	208.4	21.5	100.0	10.0	35.0
192.168.0.30	UPS Agent S...	2017/6/28 17...	104.4	110.0	2.1	100.0	34.0	31.2
192.168.0.115	BT506-Smart	2017/6/28 17...	109.0	109.6	2.2	100.0	6.0	22.3
192.168.0.211	NETPROBE.N...	2017/6/28 17...	23.38/61	0.00/50	0/80/Hu...	0.00/0...	0.00/0...	
192.168.0.211	NetProbe Mtr...	2017/6/28 17...	Min	25.00/61	10.00/1...	10/100...	0.00/0...	0.00/0...

Save As... Print... Clear All

OK Cancel

Event Log

Record List

UPS	Date	Time	Description
192.168.0.132	2017/4/19	19:51:13	NetAgent is not able to connect to UPS.
192.168.0.148	2017/4/19	19:51:14	NetAgent is not able to connect to UPS.
192.168.0.31	2017/4/19	19:51:14	NetAgent is not able to connect to UPS.
192.168.0.32	2017/4/19	19:51:14	NetAgent is not able to connect to UPS.
192.168.0.30	2017/4/19	19:51:15	NetAgent is not able to connect to UPS.
192.168.0.29	2017/4/19	19:51:15	NetAgent is not able to connect to UPS.
192.168.0.198	2017/4/19	19:51:15	NetAgent is not able to connect to UPS.
192.168.0.175	2017/4/19	19:51:15	NetAgent is not able to connect to UPS.
192.168.0.229	2017/4/19	19:51:15	NetAgent is not able to connect to UPS.
192.168.0.211	2017/4/19	19:51:15	NetAgent is not able to connect to UPS.
192.168.0.34	2017/4/19	19:51:15	NetAgent is not able to connect to UPS.
192.168.0.115	2017/4/19	19:51:15	NetAgent is not able to connect to UPS.
192.168.0.212	2017/4/19	19:51:25	NetAgent is not able to connect to UPS.
192.168.0.148	2017/4/19	19:54:9	Unable to access the device by network.
192.168.0.148	2017/4/19	19:54:57	Restore the communication with the UPS.
192.168.0.30	2017/4/19	20:1:45	NetAgent is not able to connect to UPS.
192.168.0.115	2017/4/19	20:1:45	NetAgent is not able to connect to UPS.
192.168.0.211	2017/4/19	20:1:45	NetAgent is not able to connect to UPS.
192.168.0.175	2017/4/19	20:1:45	NetAgent is not able to connect to UPS.
192.168.0.211	2017/4/19	20:1:45	NetAgent is not able to connect to UPS.

Save As... Print... Clear All

OK

Add UPS

UPS Information

IP address(Domain): 192.168.66.101

Community: public

Trap community: public

SNMP port: 161

Add subsequent 1 devices

This UPS is a 3-Phase UPS

OK Cancel

Add UPS Group

UPS Group

Group name: 2F Control room

Enable Background Map

D:\controlroom_map.bmp Browse...

OK Cancel

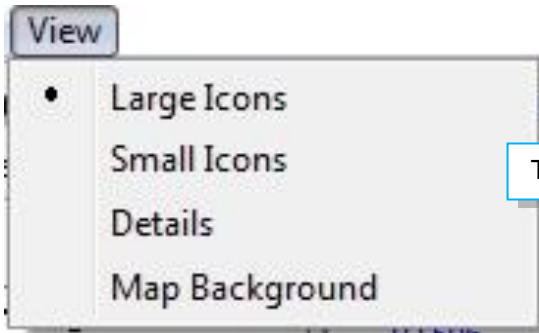

To view NetAgent with different mode



Large Icon

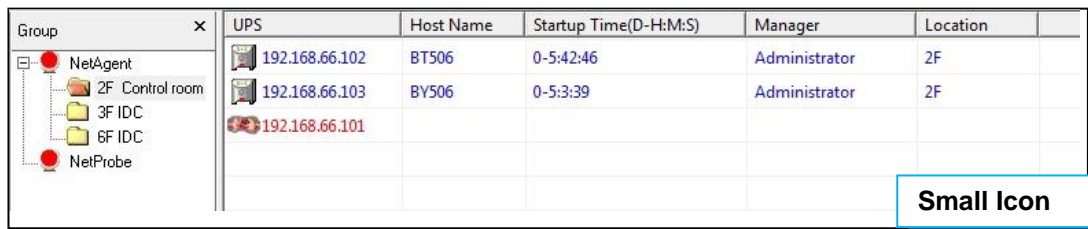

Small Icon

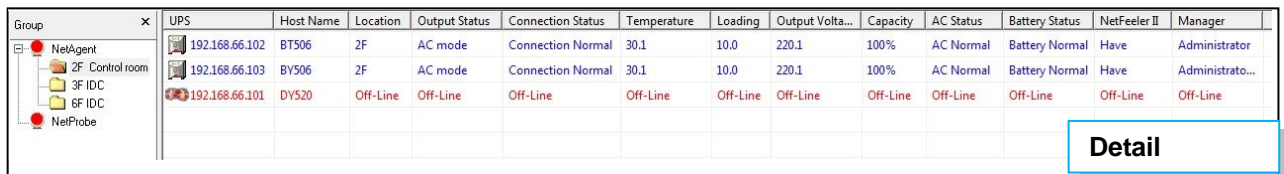

Detail

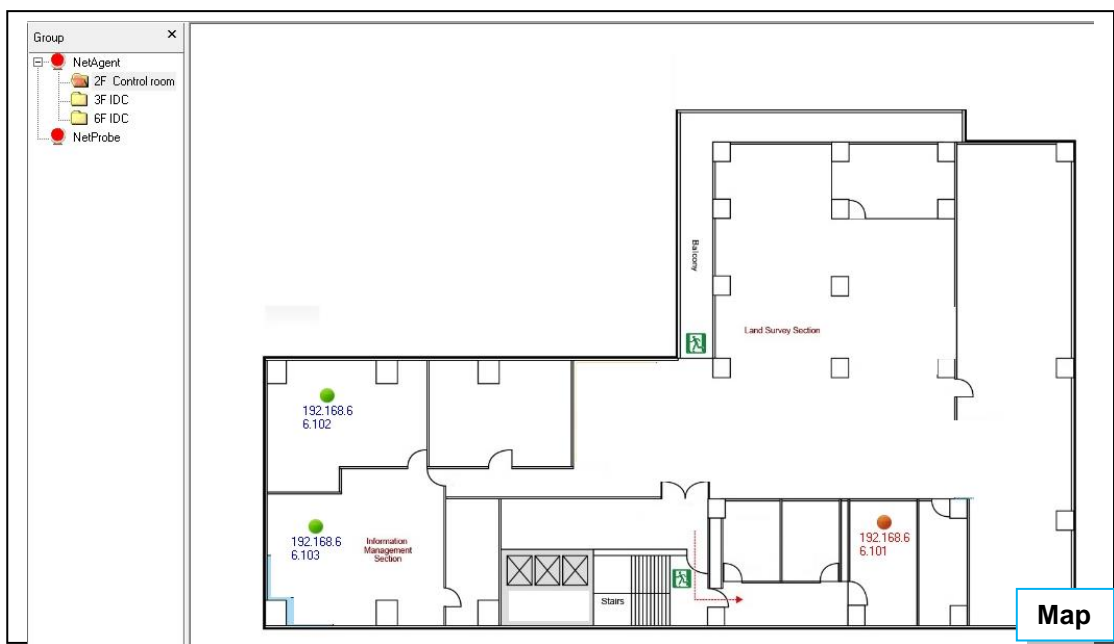

Map

Tools

- UPS Settings... **Parameter and alarm setting**
- UPS Monitor... **To view UPS status**
- Show Panel **UPS data in Chart**
- Up **Last window**
- Find... **Find NetAgent** **Ctrl+F**
- SNMP Management... **NetAgent node**
- Change Address **Change NetAgent IP**

UPS Management

Device Information

Device Name: BY506
 IP Address: 192.168.66.103
 UPS Model: Smart UPS

MIB Management

Cell in the MIB

- [UPSIdent]
- [UPSBattery]
- [UPSInput]
- [UPSOutput]
 - [Basic UPS]
 - [Smart UPS]
 - upsSmartOutputVoltage
 - upsSmartOutputFrequency
 - upsSmartOutputLoad

Selected MIB Cells

- upsSmartOutputVoltage
- upsSmartOutputFrequency
- upsSmartOutputLoad

MIB Cell Description

iso.org.dod.internet.private.enterprises.pcc.products.hardware.ups.upsoutput.upsmartoutp
 ut.upsSmartOutputLoad-1.3.6.1.4.1.935.1.1.1.4.2.3
 The current UPS load expressed in percent of rated capacity.

Manage... OK

Find

Host: 192.168.66.103

Find Cancel

UPS

Host Name: 192.168.66.103
 Startup Time(D-H:M:S): 0-6:17:51
 Manager: Administrator

Chart Meter Digital Environment Details Event Log Data Log Environment Log Control

Input Voltage Output Voltage Temperature Frequency Loading Capacity

Time	Value1	Time	Value	Time	Value1
16:21:10	220.1	16:21:11	220.1	16:21:12	220.1
16:21:10	50.0	16:21:11	50.0	16:21:12	50.0
16:21:10	100	16:21:11	100	16:21:12	100
16:21:10	100	16:21:11	100	16:21:12	100

Device--(BY506)

Data Log Digital Environment Log Details Control

Input Voltage: 220.1 V_{ac}
 Output Voltage: 220.1 V_{ac}
 Input Frequency: 50.0 Hz
 Temperature: 30.1°C

Capacity: 100%
 UPS Load: 100%

Communication has been made
 Battery Normal
 AC Power Normal
 AC mode
 Battery Voltage Normal
 Test Normal

Settings(192.168.66.103)

General E-Mail Trap List SMS Notification UPS Loading Comment

UPS Name: BY506
 Location: 2F
 Manager: Administrator
 Community: public
 Trap community: public
 SNMP port: 161
 Polling Interval: 5 Sec (default 10 sec)
 Record Data every: 5 Min (default 5 min)
 Record UPS Event
 Enable Warning Message
 Enable Broadcasting Warning Message (only for NT/2000/XP)
 This UPS is a 3-Phase UPS

OK Cancel

System

Event Log...
Data Log...
SNMP Options...

NetAgent Event log

NetAgent Data log

SNMP parameter and SMS Setting

Options

SNMP Options | System sound | SMS Settings | General

Community: public

Default Polling Interval: 5 Secs

UPS SNMP Port: 161

SNMP Trap Port: 162

No response time to determine connection(3-10 polling interval): 10 polling interval

OK Cancel

Data Log

UPS Data | Environment Data

UPS	Host Name	Startup Time...	Input Vo...	Output	Battery...	Capacity	Loading	Temper...
192.168.0.132	BT506-Smart...	2017/6/28 17...	220.1	220.1	27.1	100.0	10.0	30.1
192.168.0.148	UPQ Agent S...	2017/6/28 17...	208.4	208.4	21.5	100.0	10.0	35.0
192.168.0.31	UPS Agent S...	2017/6/28 17...	104.1	110.0	2.1	100.0	33.0	31.2
192.168.0.32	BY506-Smart...	2017/6/28 17...	108.3	109.7	2.2	100.0	5.0	22.0
192.168.0.30	NETPROBE.N...	2017/6/28 17...	23.77/60	0.00/50...	0/80Hu...	0.00/0...	0.00/0...	0.00/0...
192.168.0.29	NetProbe Mini...	2017/6/28 17...	Mini	25.47/61	10.00/1...	10/100...	0.00/0...	0.00/0...
192.168.0.198	DI520-Smart...	2017/6/28 17...	220.1	220.1	27.1	100.0	10.0	30.1
192.168.0.175	Inovel-Smart...	2017/6/28 17...	208.4	208.6	2.0	63.0	34.0	35.0
192.168.0.229	BT506-Smart...	2017/6/28 17...	220.1	220.1	27.1	100.0	10.0	30.1
192.168.0.211	UPQ Agent S...	2017/6/28 17...	208.4	208.4	21.5	100.0	10.0	35.0
192.168.0.220	UPS Agent S...	2017/6/28 17...	104.1	110.0	2.1	100.0	6.0	22.3
192.168.0.212	BY506-Smart...	2017/6/28 17...	109.0	109.6	2.2	100.0	5.0	22.3
192.168.0.212	NETPROBE.N...	2017/6/28 17...	23.36/61	0.00/50...	0/80Hu...	0.00/0...	0.00/0...	0.00/0...
192.168.0.115	NetProbe Mini...	2017/6/28 17...	Mini	25.00/61	10.00/1...	10/100...	0.00/0...	0.00/0...
192.168.0.212	DI520-Smart...	2017/6/28 17...	220.1	220.1	27.1	100.0	10.0	30.1
192.168.0.148	Inovel-Smart...	2017/6/28 17...	208.4	208.6	2.0	63.0	34.0	35.0
192.168.0.30	BT506-Smart...	2017/6/28 17...	220.1	220.1	27.1	100.0	10.0	30.1
192.168.0.30	UPQ Agent S...	2017/6/28 17...	208.4	208.4	21.5	100.0	10.0	35.0
192.168.0.175	UPS Agent S...	2017/6/28 17...	104.4	110.0	2.1	100.0	34.0	31.2
192.168.0.229	BY506-Smart...	2017/6/28 17...	109.0	109.6	2.2	100.0	5.0	22.3
192.168.0.211	NETPROBE.N...	2017/6/28 17...	23.36/61	0.00/50...	0/80Hu...	0.00/0...	0.00/0...	0.00/0...
192.168.0.115	NetProbe Mini...	2017/6/28 17...	Mini	25.00/61	10.00/1...	10/100...	0.00/0...	0.00/0...

Save As Print Clear All

OK Cancel

Event Log

Record List

UPS	Date	Time	Description
192.168.0.132	2017/4/19	19:51:13	NetAgent is not able to connect to UPS.
192.168.0.148	2017/4/19	19:51:14	NetAgent is not able to connect to UPS.
192.168.0.31	2017/4/19	19:51:14	NetAgent is not able to connect to UPS.
192.168.0.32	2017/4/19	19:51:14	NetAgent is not able to connect to UPS.
192.168.0.30	2017/4/19	19:51:15	NetAgent is not able to connect to UPS.
192.168.0.29	2017/4/19	19:51:15	NetAgent is not able to connect to UPS.
192.168.0.198	2017/4/19	19:51:15	NetAgent is not able to connect to UPS.
192.168.0.175	2017/4/19	19:51:15	NetAgent is not able to connect to UPS.
192.168.0.229	2017/4/19	19:51:15	NetAgent is not able to connect to UPS.
192.168.0.211	2017/4/19	19:51:15	NetAgent is not able to connect to UPS.
192.168.0.34	2017/4/19	19:51:15	NetAgent is not able to connect to UPS.
192.168.0.115	2017/4/19	19:51:15	NetAgent is not able to connect to UPS.
192.168.0.212	2017/4/19	19:51:25	NetAgent is not able to connect to UPS.
192.168.0.148	2017/4/19	19:54:9	Unable to access the device by network.
192.168.0.148	2017/4/19	19:54:57	Restore the communication with the UPS.
192.168.0.30	2017/4/19	20:1:45	NetAgent is not able to connect to UPS.
192.168.0.115	2017/4/19	20:1:45	NetAgent is not able to connect to UPS.
192.168.0.211	2017/4/19	20:1:45	NetAgent is not able to connect to UPS.
192.168.0.175	2017/4/19	20:1:45	NetAgent is not able to connect to UPS.
192.168.0.220	2017/4/19	20:1:45	NetAgent is not able to connect to UPS.

Save As... Print... Clear All OK

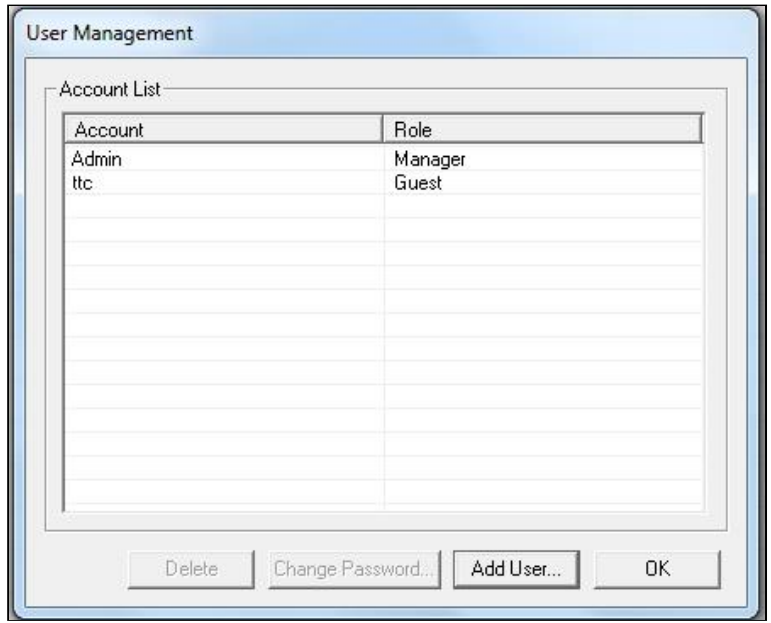

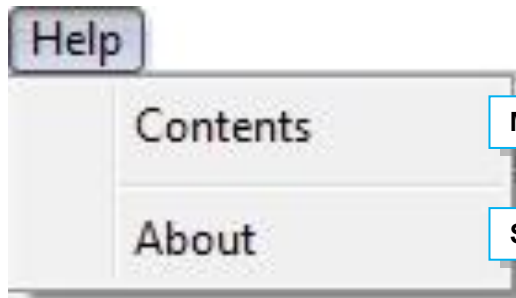

Menu Description

SNMPView Version and info

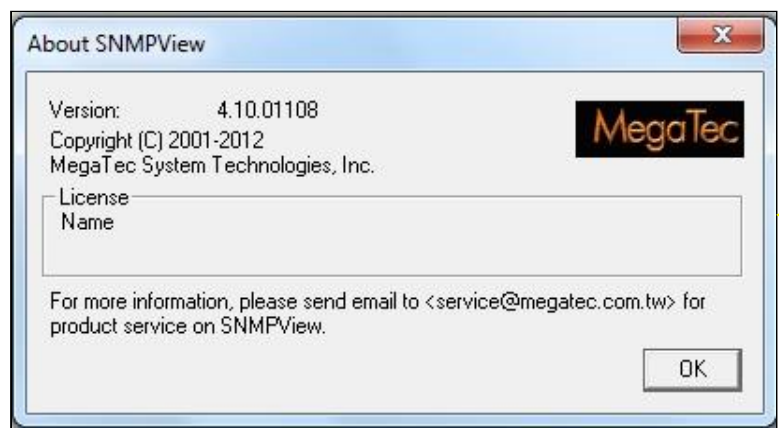

Chapter 8. iMConfig

iMConfig is a tool software that allows user to change the same parameter on multi NetAgent simultaneously.

Installation and setup

iMConfig is available in the CD provided with NetAgent. After installed, it saves under directory of

All Programs > NetAgent> iMConfig

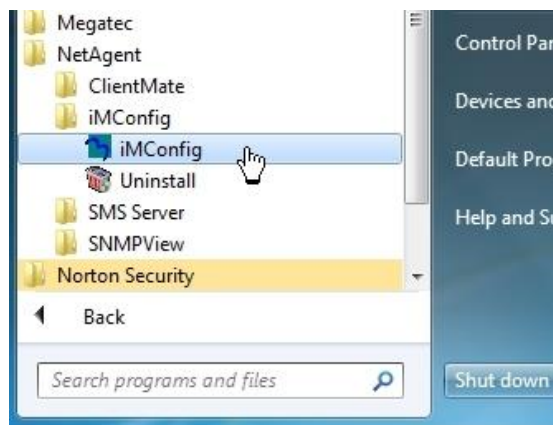

Operation Interface

Setting Section

The screenshot shows the iMConfig application window. The interface includes a menu bar (Device, Tools, View, System, Help), a toolbar with icons for Enumerate Device, Add Device, Delete, Group, Device Setting, Browse Device, View, and System Setting. On the left, a 'Group Station' tree shows a hierarchy: Technology building > 2F Control room > 3F IDC > 6F IDC. The main area is a table with columns: UPS IP, Host Name, Manager, Location, and Setting Progress. A red box highlights the 'NetAgent Information' area, which contains a status indicator (Connection Normal) and a button (Disconnect with NetAgent). A status bar at the bottom shows: 0 UPS, 0 UPS group has been selected | 3 UPS in the list, 1 UPS lost communication. | 10:41:00. Annotations with arrows point to the 'Setting Section' (toolbar), 'Group Station' (tree), 'NetAgent Information' (status box), and 'Connection Information' (status bar).

UPS IP	Host Name	Manager	Location	Setting Progress
192.168.66.102	BT506	Administrator	2F	Ready
192.168.66.103	BY506	Administrator	2F	Ready
192.168.66.101	DY520	Administrator	2F	Ready

Group Station

NetAgent Information

Connection Normal

Disconnect with NetAgent

0 UPS, 0 UPS group has been selected | 3 UPS in the list, 1 UPS lost communication. | 10:41:00

Connection Information

Setting Tab

Device

Enumerate Device	F5	Auto search online NetAgent
Add Group...	F6	Add NetAgent into Group
Add Device...	Ins	Add NetAgent
Delete	Del	Delete NetAgent
Browse Device...		Browse NetAgent
Quit		

Add UPS

UPS Information

IP or Domain name: 192.168.66.101

Community: public

Add subsequent 1 devices

OK Cancel

Add UPS Group

UPS Group

Group name: 2F Control building

Enable Background Map

D:\controlroom_map.bmp Browse...

OK Cancel

Tools

Authentication...	Username/password setting
Settings...	NetAgent Parameter Setting

UPS Configuration | UPS On/Off Schedule | SNMP | Email | SMS | System Time | Modem | NetFeeler II

UPS Properties

B. UPS Communication Type: Contact Closure

C. Number of Batteries: []

D. Battery Full Charge Voltage (V): []

E. Battery Exhausted Charge Voltage (V): []

F. Date of last battery replacement (yyyy/mm/dd): []

UPS Recorded

G. UPS Data Log: [] minute(s)

Test UPS

H. Test UPS every: None

I. Test UPS on Weekday: Sunday

J. Start Time of UPS Test (h:mm): []

K. UPS Test Type: 10-Second Test [] minute(s)

Warning Threshold Value

L. Time out after loss of connection: 30 seconds

M. Critical Load (%): []

N. Critical Temperature (Celsius): []

O. Critical Capacity (%): []

OK Cancel

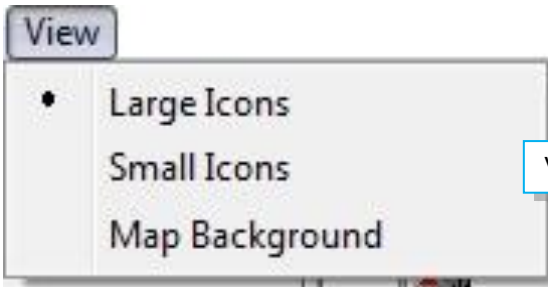

View with different mode

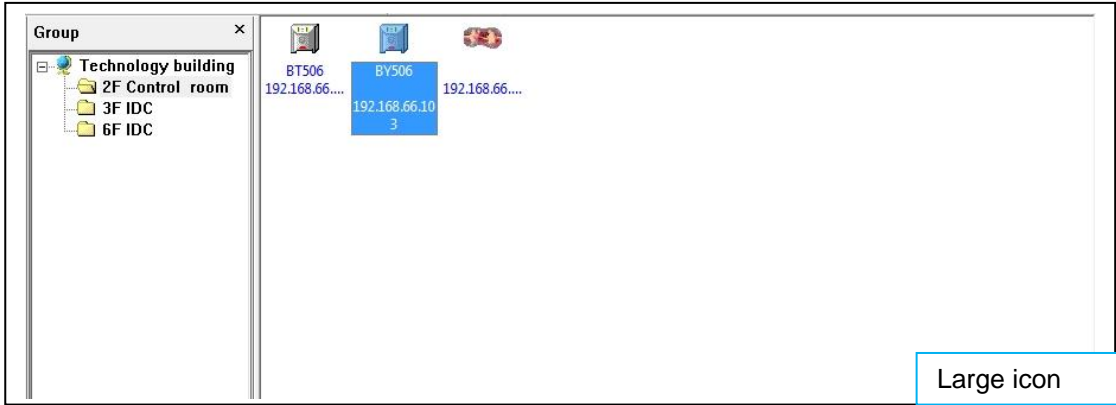

Large icon

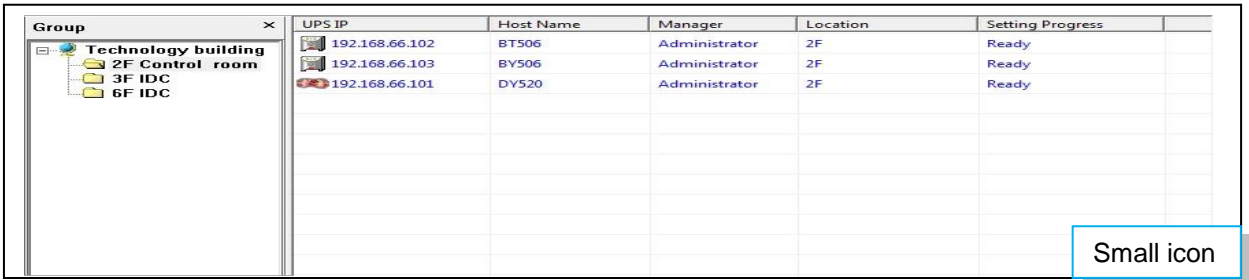

Small icon

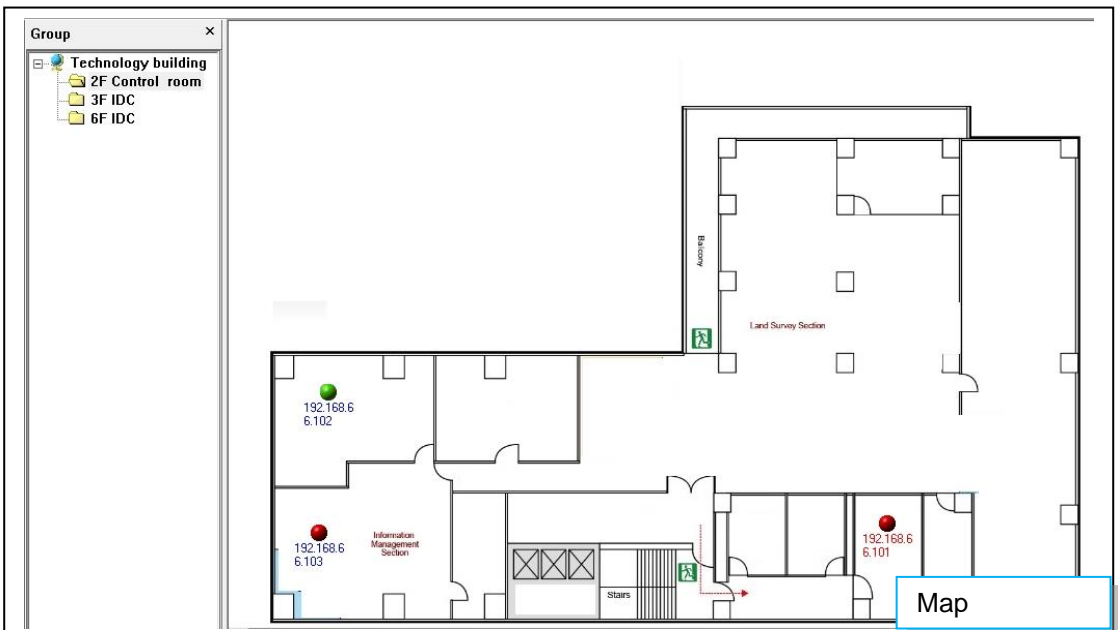

Map

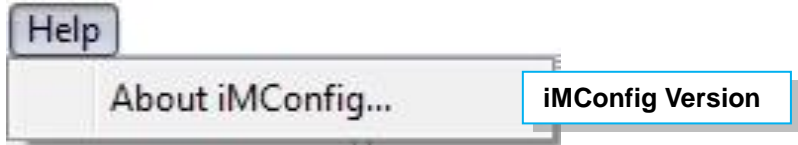
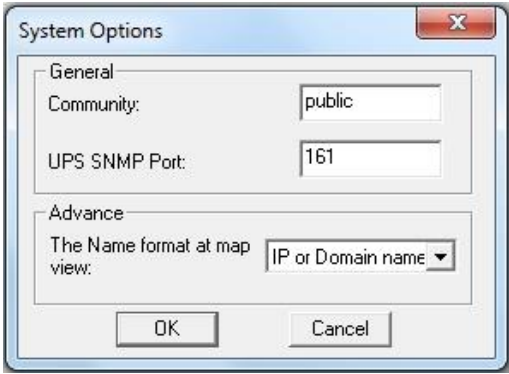
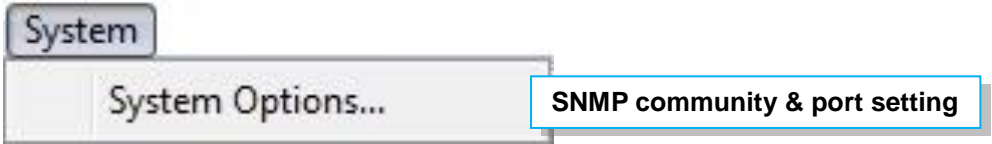

Chapter 9. SMS Server Software

SMS notification can be send by modem that connects to 3 ports NetAgent II or NetAgent 9 (BX/BY) model directly, or , it can also be achieved by the remote PC that has SMS Server software installed with modem connected

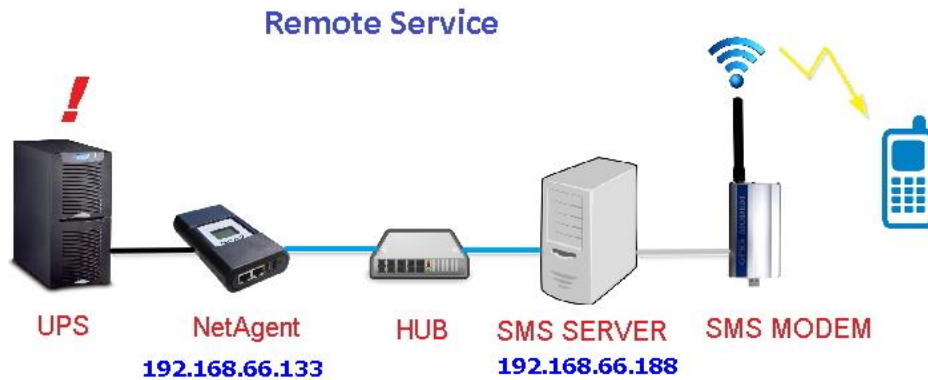

Modem Installation

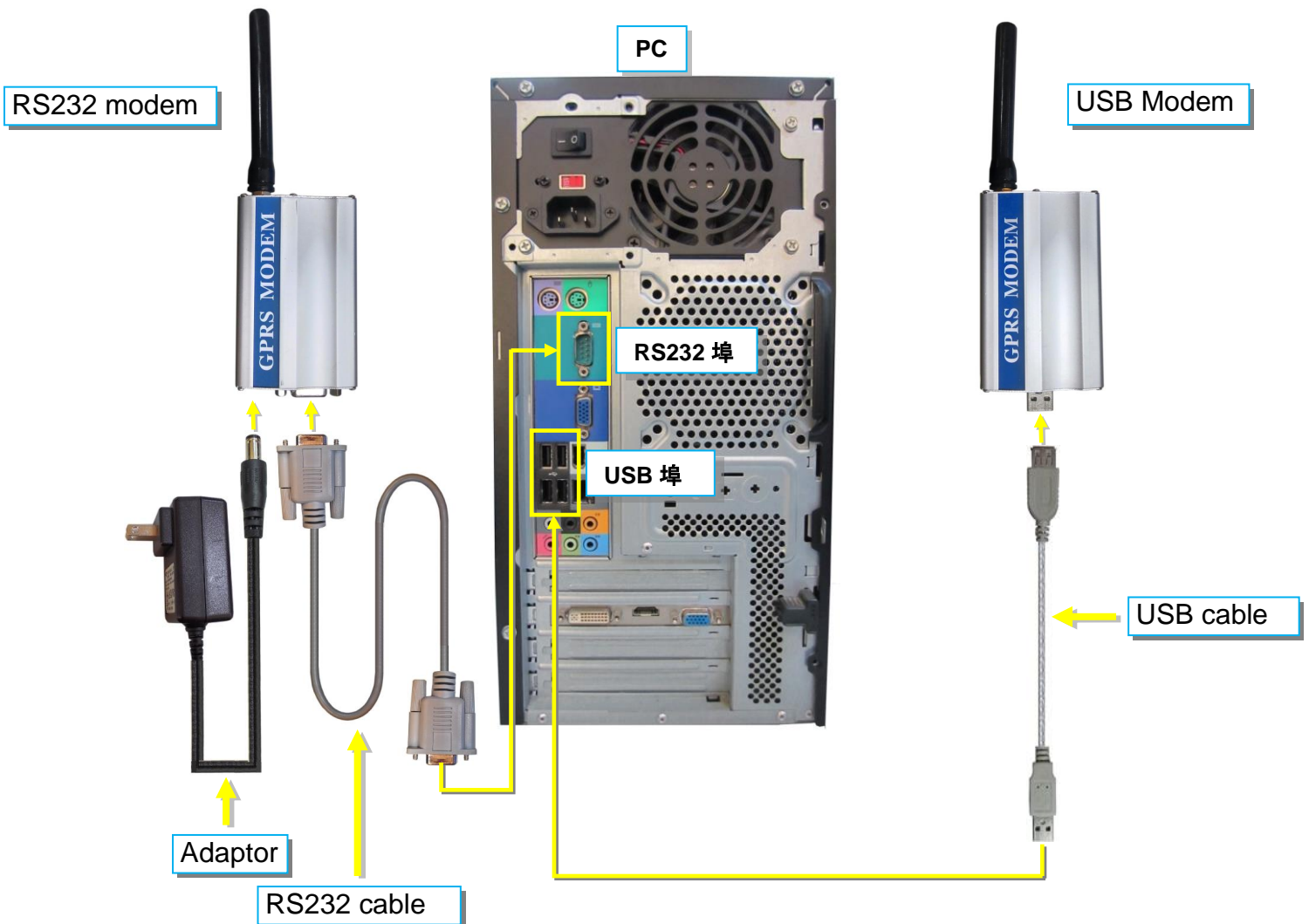

SMS Server Software Installation

SMS Server software is available in the CD provided with NetAgent. After installed, it saves under directory of

All Programs > NetAgent>SMS Server>SMS Server Manager

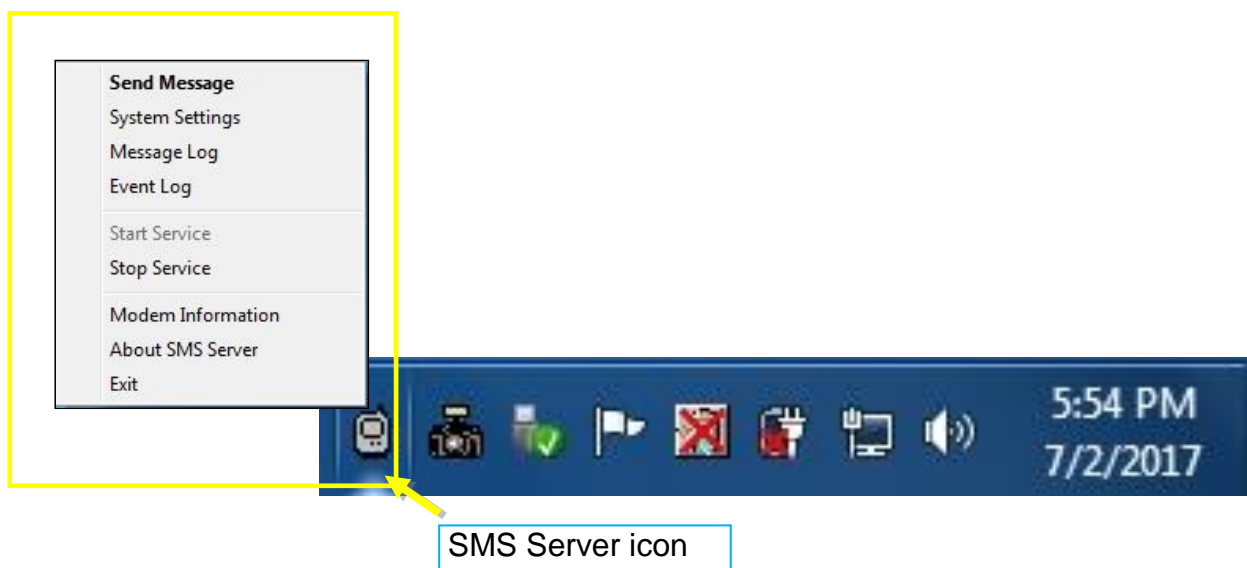
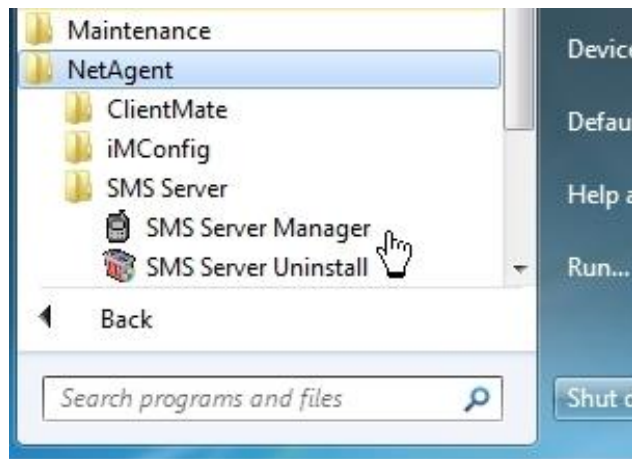

Settings

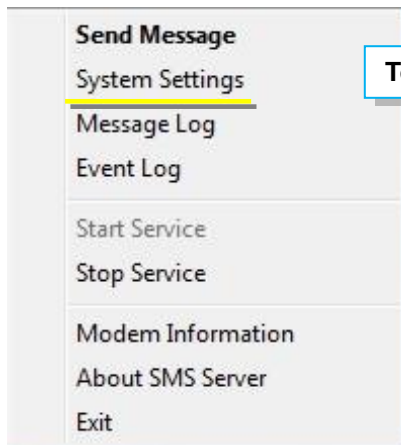

To configure type of modem, port, SIM PIN

Check the virtual port number when using with USB modem

Select COM port of COM1,COM2.. when using with RS232 modem

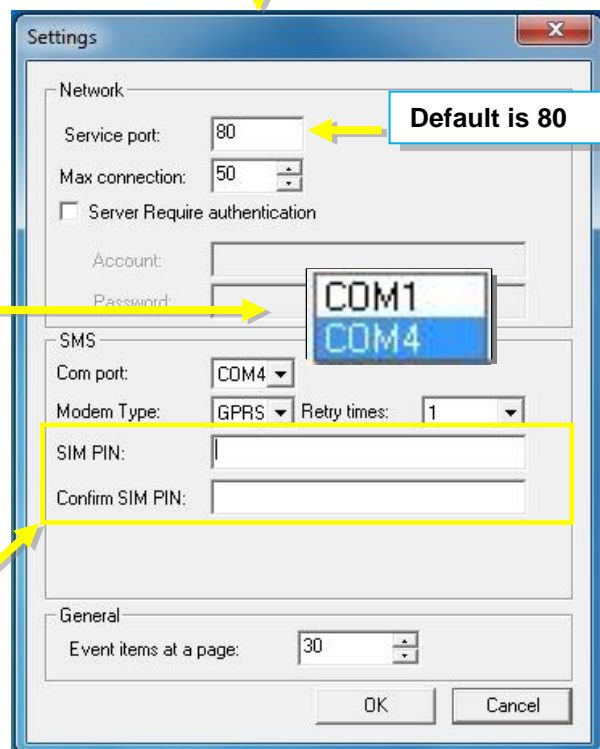

Default is 80

If PIN required, please enter

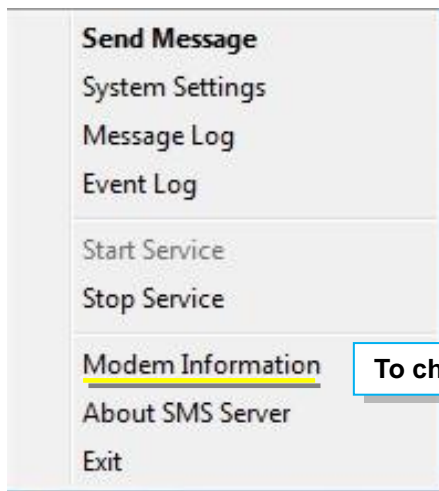

To check modem information and connection status

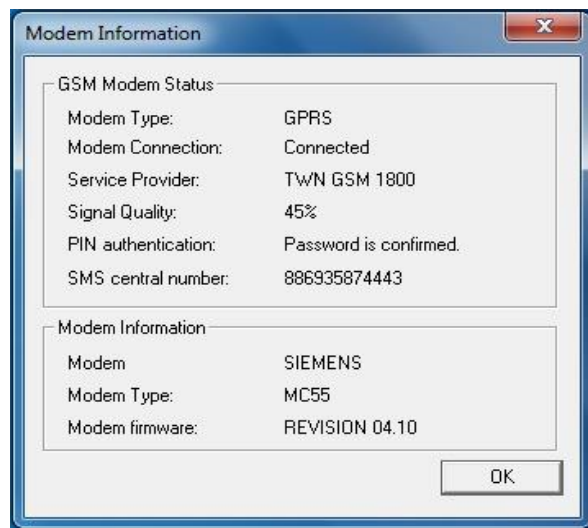

-Ensure all settings are correct and modem is connected with signal in order to send SMS successfully

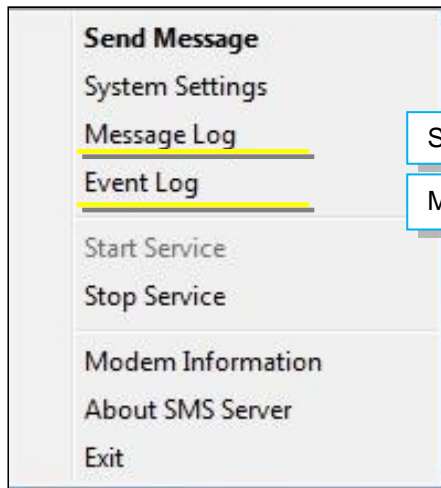

SMS Sending log

Modem operation log

Event List

NO.	Type	Number	Address	Result	Time	Content
1	System I...	00000000000	127.0...	FAIL	2017/05/14 11:39:04	Serial communi
2	System I...	00000000000	127.0...	OK	2017/05/14 11:42:03	Service startup
3	System I...	00000000000	127.0...	FAIL	2017/05/14 11:42:03	Serial communi
000	127.0...			OK	2017/05/14 11:47:41	Service startup
000	127.0...			FAIL	2017/05/14 11:47:41	Serial communi
000	127.0...			OK	2017/05/14 15:36:58	Service startup
000	127.0...			FAIL	2017/05/14 15:36:58	Serial communi
000	127.0...			OK	2017/05/14 16:39:45	Service startup
000	127.0...			FAIL	2017/05/14 16:39:45	Serial communi
000	127.0...			OK	2017/05/15 09:27:35	Service startup
000	127.0...			FAIL	2017/05/15 09:27:35	Serial communi
000	127.0...			OK	2017/05/16 08:49:24	Service startup
000	127.0...			FAIL	2017/05/16 08:49:24	Serial communi
000	127.0...			OK	2017/05/17 08:54:44	Service startup
000	127.0...			FAIL	2017/05/17 08:54:44	Serial communi
000	127.0...			OK	2017/05/17 14:32:47	Service startup
000	127.0...			FAIL	2017/05/17 14:32:47	Serial communi
000	127.0...			OK	2017/05/17 15:20:53	Service startup
000	127.0...			FAIL	2017/05/17 15:20:53	Serial communi
000	127.0...			OK	2017/05/18 09:26:49	Service startup
000	127.0...			FAIL	2017/05/18 09:26:49	Serial communi
000	127.0...			OK	2017/05/18 10:02:41	Service startup
000	127.0...			FAIL	2017/05/18 10:02:41	Serial communi
000	127.0...			OK	2017/05/21 08:47:52	Service startup
000	127.0...			FAIL	2017/05/21 08:47:52	Serial communi
000	192.1...			FAIL	2017/05/21 13:46:35	No this URL(1!
000	192.1...			FAIL	2017/05/21 13:46:37	No this URL(1!
000	192.1...			FAIL	2017/05/21 13:46:41	No this URL(1!
000	192.1...			FAIL	2017/05/21 13:46:57	No this URL(1!
000	192.1...			FAIL	2017/05/21 13:47:01	No this URL(1!

is page 1, there are 30 items in this page, total 46 pages. Double-Click to

Page Up Page Down Page: 1 Delete... OK

Message List

NO.	Type	Number	Address	Result	Time	Content
1	Send	0955655657	192.1...	OK	2017/05/10 19:13:44	UPS Agent(My
2	Send	0917461025	192.1...	OK	2017/05/10 19:14:59	UPS Agent(My
3	Send	0922726209	192.1...	OK	2017/05/10 19:22:33	UPS Agent(My
4	Send	0955955657	192.1...	OK	2017/05/10 19:23:14	UPS Agent(My

30 items in every page, current is page 1, there are 4 items in this page, total 1 pages. Double-Click to fresh

First Page Last Page Page Up Page Down Page: 1 Delete... OK

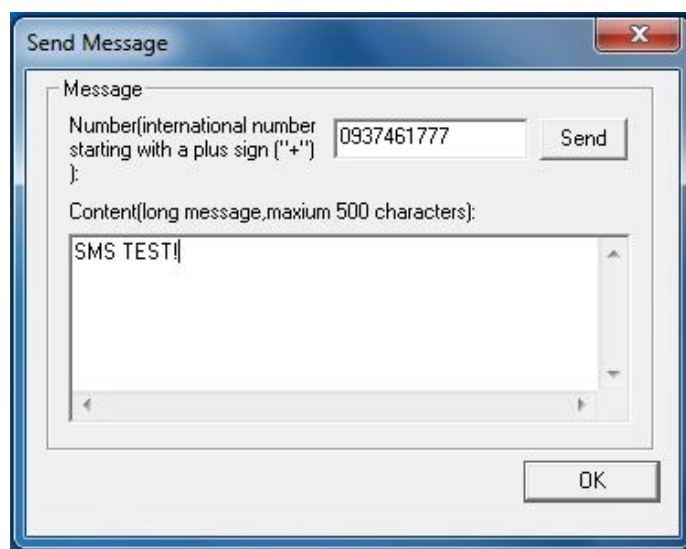
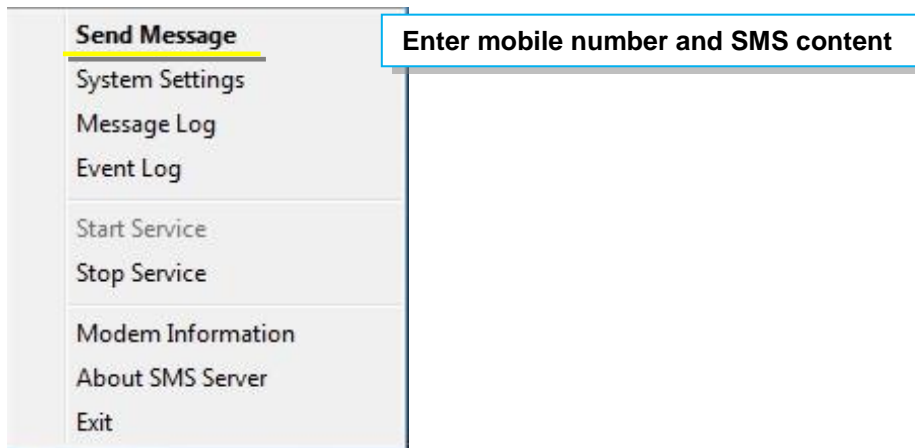

When SMS Server software installation and connection are both complete, the IP address of PC may be entered in the NetAgent's SMS webpage and select "Use Remote Service". Such NetAgent would then be able to send SMS notification via this SMS Server PC

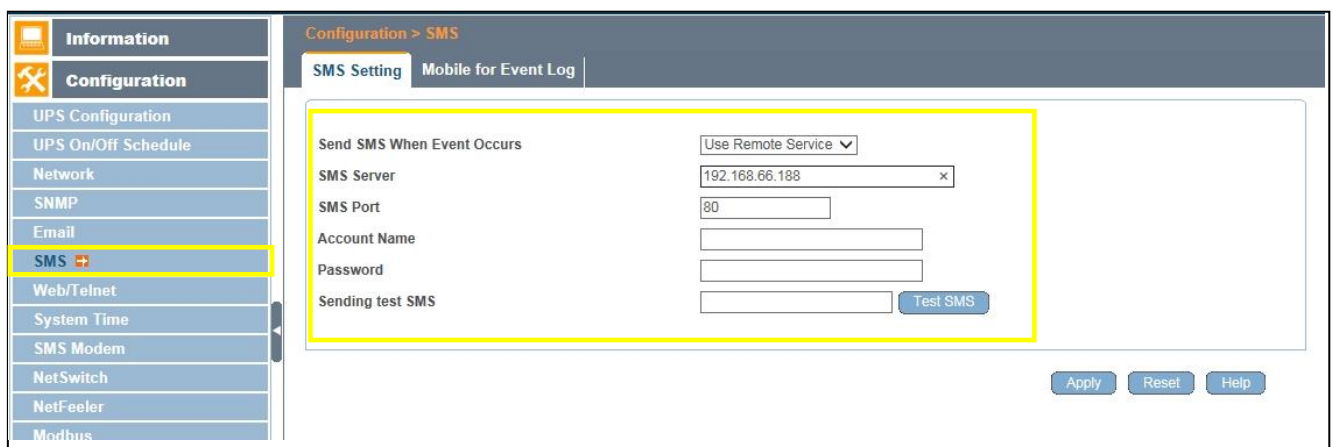

Chapter 10. Appendix

When Netility and NetAgent's username/password are lost, please follow the steps below to clear or check the configuration

1. Get the PC that is under same network as NetAgent-SNMP card
2. Open up the browser and type <http://xxx.xx/password.cgi> (xx.xxx is the IP address of the NetAgent)



3. Enter ID: admin

Password: Enter the master password for the device

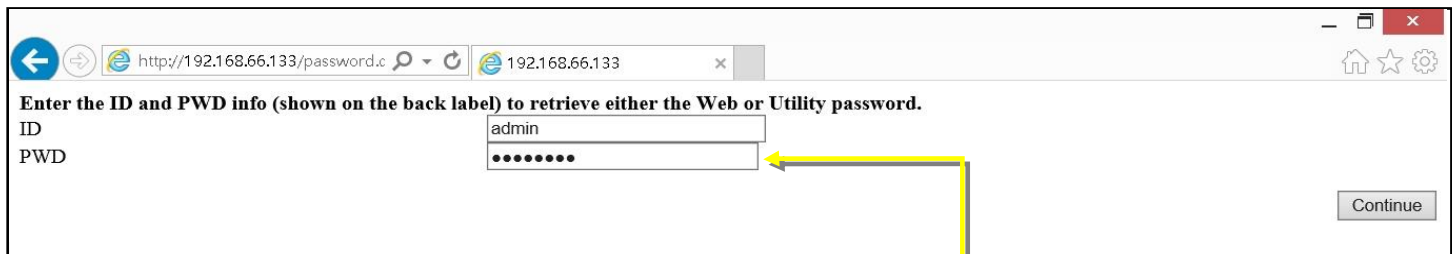

4. Press continue and clear

