

Content

CONTENT	1
CHAPTER 1 BASIC MANAGEMENT CONFIGURATION	1
1.1 SWITCH MANAGEMENT	1
1.1.1 Management Options	1
1.1.2 CLI Interface	10
1.2 BASIC SWITCH CONFIGURATION	15
1.2.1 Basic Configuration	15
1.2.2 Telnet Management	16
1.2.3 Configure Switch IP Addresses	20
1.2.4 SNMP Configuration	21
1.2.5 Switch Upgrade	28
1.3 FILE SYSTEM	38
1.3.1 Introduction to File Storage Devices	38
1.3.2 File System Operation Configuration Task list	38
1.3.3 Typical Applications	39
1.3.4 Troubleshooting	40
1.4 CLUSTER	40
1.4.1 Introduction to cluster network management	40
1.4.2 Cluster Network Management Configuration Sequence	41
1.4.3 Examples of Cluster Administration	44
1.4.4 Cluster Administration Troubleshooting	44
1.5 USB	45
1.5.1 Introduction	45
1.5.2 USB Function Configuration List	45
1.5.3 USB Function Examples	47
1.5.4 USB Function Troubleshooting	47
1.6 DEVICE MANAGEMENT	47
1.6.1 Device Management Brief	47
1.6.2 Device Management Configuration	48

CHAPTER 2 NETWORK SECURITY OPERATIONS MANUAL ..49

2.1 INTRODUCTION TO NETWORK SECURITY FEATURES	49
2.2 NETWORK SECURITY FEATURE CONFIGURATION	49
2.2.1 Modification of Port Number Function Configuration Task Sequence	49
2.2.2 Modify the configuration task sequence of the encryption algorithm function	50
2.2.3 Password security function configures task sequence	50
2.2.4 Configure the task sequence of the sensitive information encryption function	51
2.2.5 Configure the task sequence of the important file verification function	51

CHAPTER 3 LAYER 2 SERVICES CONFIGURATION 1

3.1 PORT CONFIGURATION	1
3.1.1 Introduction to Port	1
3.1.2 Network Port Configuration Task List	1
3.1.3 Port Configuration Example	3
3.1.4 Port Troubleshooting	4
3.2 PORT ISOLATION	4
3.2.1 Introduction to Port Isolation Function	4
3.2.2 Task Sequence of Port Isolation	5
3.2.3 Port Isolation Function Typical Examples	6
3.3 PORT LOOPBACK DETECTION	7
3.3.1 Introduction to Port Loopback Detection Function	7
3.3.2 Port Loopback Detection Function Configuration Task List	7
3.3.3 Port Loopback Detection Function Example	9
3.3.4 Port Loopback Detection Troubleshooting	9
3.4 ULDP	10
3.4.1 Introduction to ULDP Function	10
3.4.2 ULDP Configuration Task Sequence	11
3.4.3 ULDP Function Typical Examples	13
3.4.4 ULDP Troubleshooting	15
3.5 LLDP	16

3.5.1 Introduction to LLDP Function	16
3.5.2 LLDP Function Configuration Task Sequence	17
3.5.3 LLDP Function Typical Example	19
3.5.4 LLDP Function Troubleshooting	20
3.6 LLDP-MED	20
3.6.1 Introduction to LLDP-MED	20
3.6.2 LLDP-MED Configuration Task Sequence	21
3.6.3 LLDP-MED Example	22
3.6.4 LLDP-MED Troubleshooting	25
3.7 PORT CHANNEL	25
3.7.1 Introduction to Port Channel	25
3.7.2 Brief Introduction to LACP	27
3.7.3 Introduction to Load balance	28
3.7.4 Port Channel Configuration Task List	28
3.7.5 Port Channel Examples	31
3.7.6 Troubleshooting	33
3.8 MTU	33
3.8.1 Introduction to MTU	33
3.8.2 MTU Configuration Task Sequence	34
3.9 BPDU-TUNNEL	34
3.9.1 Introduction to bpdu-tunnel	34
3.9.2 bpdu-tunnel Configuration Task List	35
3.9.3 Examples of bpdu-tunnel	36
3.9.4 bpdu-tunnel Troubleshooting	37
3.10 DDM	37
3.10.1 Introduction to DDM	37
3.10.2 DDM Configuration Task List	39
3.10.3 Examples of DDM	40
3.10.4 DDM Troubleshooting	44
3.11 EFM OAM	44
3.11.1 Introduction to EFM OAM	44
3.11.2 EFM OAM Configuration	47
3.11.3 EFM OAM Example	49
3.11.4 EFM OAM Troubleshooting	50

3.12 PORT SECURITY	51
3.12.1 Introduction to PORT SECURITY	51
3.12.2 PORT SECURITY Configuration Task List	51
3.12.3 Example of PORT SECURITY	52
3.12.4 PORT SECURITY Troubleshooting	52
3.13 VLAN	53
3.13.1 Introduction to VLAN	53
3.13.2 VLAN Configuration Task List	54
3.13.3 Typical VLAN Application	56
3.13.4 Typical Application of Hybrid Port	58
3.14 GVRP	60
3.14.1 Introduction to GVRP	60
3.14.2 GVRP Configuration Task List	61
3.14.3 Example of GVRP	61
3.14.4 GVRP Troubleshooting	63
3.15 DOT1Q-TUNNEL	63
3.15.1 Introduction to Dot1q-tunnel	63
3.15.2 Dot1q-tunnel Configuration	64
3.15.3 Typical Applications of the Dot1q-tunnel	65
3.15.4 Dot1q-tunnel Troubleshooting	66
3.16 VLAN-TRANSLATION	66
3.16.1 Introduction to VLAN-translation	66
3.16.2 VLAN-translation Configuration	66
3.16.3 Typical application of VLAN-translation	67
3.17 DYNAMIC VLAN	68
3.17.1 Introduction to Dynamic VLAN	68
3.17.2 Dynamic VLAN Configuration	69
3.17.3 Typical Application of the Dynamic VLAN	71
3.17.4 Dynamic VLAN Troubleshooting	72
3.18 VOICE VLAN	72
3.18.1 Introduction to Voice VLAN	72
3.18.2 Voice VLAN Configuration	73
3.18.3 Typical Applications of the Voice VLAN	73
3.18.4 Voice VLAN Troubleshooting	75

3.19 SUPER VLAN	75
3.19.1 Introduction to Super VLAN	75
3.19.2 Super VLAN Configuration	77
3.19.3 Typical Application of Super VLAN	78
3.19.4 Super VLAN Troubleshooting	79
3.20 MAC TABLE	79
3.20.1 Introduction to MAC Table	79
3.20.2 Mac Address Table Configuration Task List	82
3.20.3 Typical Configuration Examples	83
3.20.4 MAC Table Troubleshooting	84
3.21 RMON	84
3.21.1 Rmon introduction	84
3.21.2 Rmon configuration	86
3.21.3 Rmon for examples	87
3.21.4 Rmon Troubleshooting	91
CHAPTER 4 IP SERVICES CONFIGURATION	1
4.1 LAYER 3 INTERFACE	1
4.1.1 Introduction to Layer 3 Interface	1
4.1.2 Layer 3 Interface Configuration Task List	1
4.2 NETWORK MANAGEMENT PORT	3
4.2.1 Introduce to IP Network Management Port	3
4.2.2 Network Management Port Configuration	3
4.3 IP CONFIGURATION	3
4.3.1 Introduction to IPv4, IPv6	3
4.3.2 IP Configuration	5
4.3.3 IP Configuration Examples	10
4.3.4 IPv6 Troubleshooting	15
4.4 IP FORWARDING	15
4.4.1 Introduction to IP Forwarding	15
4.4.2 IP Route Aggregation Configuration Task	16
4.5 URPF	16
4.5.1 Introduction to URPF	16

4.5.2 URPF Configuration Task Sequence	17
4.5.3 URPF Typical Example	18
4.5.4 URPF Troubleshooting	18
4.6 ARP	19
4.6.1 Introduction to ARP	19
4.6.2 ARP Configuration Task List	19
4.6.3 ARP Troubleshooting	20
4.7 ARP SCANNING PREVENTION	20
4.7.1 Introduction to ARP Scanning Prevention Function	20
4.7.2 ARP Scanning Prevention Configuration Task Sequence	21
4.7.3 ARP Scanning Prevention Typical Examples	23
4.7.4 ARP Scanning Prevention Troubleshooting Help	24
4.8 PREVENT ARP SPOOFING	24
4.8.1 Overview	24
4.8.2 Prevent ARP Spoofing configuration	25
4.8.3 Prevent ARP Spoofing Example	26
4.9 ARP GUARD	27
4.9.1 Introduction to ARP GUARD	27
4.9.2 ARP GUARD Configuration Task List	28
4.10 ARP LOCAL PROXY	28
4.10.1 Introduction to ARP Local Proxy function	28
4.10.2 ARP Local Proxy Function Configuration Task List	29
4.10.3 Typical Examples of ARP Local Proxy Function	30
4.10.4 ARP Local Proxy Function Troubleshooting	30
4.11 GRATUITOUS ARP CONFIGURATION	31
4.11.1 Introduction to Gratuitous ARP	31
4.11.2 Gratuitous ARP Configuration Task List	31
4.11.3 Gratuitous ARP Configuration Example	32
4.11.4 Gratuitous ARP Troubleshooting	32
4.12 KEEPALIVE GATEWAY	33
4.12.1 Introduction to Keepalive Gateway	33
4.12.2 Keepalive Gateway Configuration Task List	33
4.12.3 Keepalive Gateway Example	34
4.12.4 Kernalive Gteway Troubleshooting	34

4.13 DHCP	35
4.13.1 Introduction to DHCP	35
4.13.2 DHCP Server Configuration	36
4.13.3 DHCP Relay Configuration	38
4.13.4 DHCP Configuration Examples	39
4.13.5 DHCP Troubleshooting	41
4.14 DHCP OPTION 82	42
4.14.1 Introduction to DHCP option 82	42
4.14.2 DHCP option 82 Configuration Task List	44
4.14.3 DHCP option 82 Application Examples	47
4.14.4 DHCP option 82 Troubleshooting	48
4.15 DHCP SNOOPING	49
4.15.1 Introduction to DHCP Snooping	49
4.15.2 DHCP Snooping Configuration Task Sequence	50
4.15.3 DHCP Snooping Typical Application	54
4.15.4 DHCP Snooping Troubleshooting Help	55
4.16 DHCP OPTION 60 AND OPTION 43	55
4.16.1 Introduction to DHCP option 60 and option 43	55
4.16.2 DHCP option 60 and option 43 Configuration Task List	55
4.16.3 DHCPv6 option 60 and option 43 Example	56
4.16.4 DHCP option 60 and option 43 Troubleshooting	57
CHAPTER 5 ROUTING PROTOCOL RELATED	
CONFIGURATION	1
5.1 ROUTING PROTOCOL OVERVIEW	1
5.1.1 Routing Table	1
5.1.2 IP Routing Policy	2
5.2 STATIC ROUTE	9
5.2.1 Introduction to Static Route	9
5.2.2 Introduction to Default Route	9
5.2.3 Static Route Configuration Task List	9
5.2.4 Static Route Configuration Examples	10
5.3 RIP	11

5.3.1 Introduction to RIP	11
5.3.2 RIP Configuration Task List	13
5.3.3 RIP Examples	18
5.3.4 RIP Troubleshooting	21
5.4 OSPF	21
5.4.1 Introduction to OSPF	21
5.4.2 OSPF Configuration Task List	24
5.4.3 OSPF Examples	29
5.4.4 OSPF Troubleshooting	38
5.5 BGP	39
5.5.1 Introduction to BGP	39
5.5.2 BGP Configuration Task List	41
5.5.3 Configuration Examples of BGP	52
5.5.4 BGP Troubleshooting	64
5.6 IPV4 BLACK HOLE ROUTING	65
5.6.1 Introduction to Black Hole Routing	65
5.6.2 IPv4 Black Hole Routing Configuration Task	65
5.6.3 Black Hole Routing Configuration Exmaples	65
5.6.4 Black Hole Routing Troubleshooting	66
5.7 GRE	67
5.7.1 Introduction to GRE Tunnel	67
5.7.2 GRE Tunnel Basic Configuration	67
5.7.3 Example of GRE Tunnel	69
5.7.4 Example of GRE Tunnel Quotes Loopback Group	72
5.7.5 GRE Tunnel Troubleshooting	76
5.8 ECMP	76
5.8.1 Introduction to ECMP	76
5.8.2 ECMP Configuration Task List	77
5.8.3 ECMP Typical Example	77
5.8.4 ECMP Troubleshooting	80
5.9 BFD	80
5.9.1 Introduction to BFD	80
5.9.2 BFD Configuration Task List	81
5.9.3 Examples of BFD	83

5.9.4 BFD Troubleshooting	86
5.10 BGP GR	86
5.10.1 Introduction to GR	86
5.10.2 GR Configuration Task List	87
5.10.3 Typical Example of GR	89
5.11 OSPF GR	90
5.11.1 Introduction to OSPF GR	90
5.11.2 OSPF GR Configuration	91
5.11.3 OSPF GR Example	92
5.11.4 OSPF GR Troubleshooting	93
CHAPTER 6 IPV4 MULTICAST PROTOCOL RELATED	
CONFIGURATION	1
6.1 IPV4 MULTICAST PROTOCOL OVERVIEW	1
6.1.1 Introduction to Multicast	1
6.1.2 Multicast Address	1
6.1.3 IP Multicast Packet Transmission	3
6.1.4 IP Multicast Application	3
6.2 PIM-DM	3
6.2.1 Introduction to PIM-DM	3
6.2.2 PIM-DM Configuration Task List	5
6.2.3 PIM-DM Configuration Examples	6
6.2.4 PIM-DM Troubleshooting	7
6.3 PIM-SM	8
6.3.1 Introduction to PIM-SM	8
6.3.2 PIM-SM Configuration Task List	9
6.3.3 PIM-SM Configuration Examples	12
6.3.4 PIM-SM Troubleshooting	14
6.4 MSDP CONFIGURATION	14
6.4.1 Introduction to MSDP	14
6.4.2 Brief Introduction to MSDP Configuration Tasks	15
6.4.3 Configuration of MSDP Basic Function	16
6.4.4 Configuration of MSDP Entities	17

6.4.5 Configuration of Delivery of MSDP Packet	17
6.4.6 Configuration of Parameters of SA-cache	18
6.4.7 MSDP Configuration Examples	18
6.4.8 MSDP Troubleshooting	24
6.5 ANYCAST RP CONFIGURATION	24
6.5.1 Introduction to ANYCAST RP	24
6.5.2 ANYCAST RP Configuration Task	25
6.5.3 ANYCAST RP Configuration Examples	27
6.5.4 ANYCAST RP Troubleshooting	29
6.6 PIM-SSM	29
6.6.1 Introduction to PIM-SSM	29
6.6.2 PIM-SSM Configuration Task List	30
6.6.3 PIM-SSM Configuration Examples	30
6.6.4 PIM-SSM Troubleshooting	32
6.7 DVMRP	32
6.7.1 Introduction to DVMRP	32
6.7.2 DVMRP Configuration Task List	33
6.7.3 DVMRP Configuration Examples	35
6.7.4 DVMRP Troubleshooting	36
6.8 DCSCM	36
6.8.1 Introduction to DCSCM	36
6.8.2 DCSCM Configuration Task List	37
6.8.3 DCSCM Configuration Examples	39
6.8.4 DCSCM Troubleshooting	40
6.9 IGMP	41
6.9.1 Introduction to IGMP	41
6.9.2 IGMP Configuration Task List	42
6.9.3 IGMP Configuration Examples	44
6.9.4 IGMP Troubleshooting	45
6.10 IGMP SNOOPING	46
6.10.1 Introduction to IGMP Snooping	46
6.10.2 IGMP Snooping Configuration Task List	46
6.10.3 IGMP Snooping Examples	49
6.10.4 IGMP Snooping Troubleshooting	51

6.11 IGMP PROXY CONFIGURATION	51
6.11.1 Introduction to IGMP Proxy	51
6.11.2 IGMP Proxy Configuration Task List	52
6.11.3 IGMP Proxy Examples	53
6.11.4 IGMP Proxy Troubleshooting	55
6.12 MULTICAST VLAN	56
6.12.1 Introductions to Multicast VLAN	56
6.12.2 Multicast VLAN Configuration Task List	56
6.12.3 Multicast VLAN Examples	57
CHAPTER 7 SECURITY FUNCTION CONFIGURATION	1
7.1 ACL CONFIGURATION	1
7.1.1 Introduction to ACL	1
7.1.2 ACL Configuration Task List	2
7.1.3 ACL Example	16
7.1.4 ACL Troubleshooting	19
7.2 SELF-DEFINED ACL	20
7.2.1 Introduction to Self-defined ACL	20
7.2.2 Self-defined ACL Configuration	21
7.2.3 Self-defined ACL Example	22
7.2.4 Self-defined ACL Troubleshooting	23
7.3 802.1x	23
7.3.1 Introduction to 802.1x	23
7.3.2 802.1x Configuration Task List	35
7.3.3 802.1x Application Example	37
7.3.4 802.1x Troubleshooting	42
7.4 THE NUMBER LIMITATION FUNCTION OF MAC AND IP IN PORT, VLAN ...	42
7.4.1 Introduction to the Number Limitation Function of MAC and IP in Port, VLAN	42
7.4.2 The Number Limitation Function of MAC and IP in Port, VLAN Configuration Task Sequence	43
7.4.3 The Number Limitation Function of MAC and IP in Port, VLAN Typical Examples	45
7.4.4 The Number Limitation Function of MAC and IP in Port, VLAN	

Troubleshooting Help	46
7.5 AM	47
7.5.1 Introduction to AM Function	47
7.5.2 AM Function Configuration Task List	47
7.5.3 AM Function Example	48
7.5.4 AM Function Troubleshooting	49
7.6 SECURITY FEATURE	49
7.6.1 Introduction to Security Feature	49
7.6.2 Security Feature Configuration	49
7.6.3 Security Feature Example	51
7.7 TACACS+	51
7.7.1 Introduction to TACACS+	51
7.7.2 TACACS+ Configuration Task List	52
7.7.3 TACACS+ Scenarios Typical Examples	53
7.7.4 TACACS+ Troubleshooting	53
7.8 RADIUS	54
7.8.1 Introduction to RADIUS	54
7.8.2 RADIUS Configuration Task List	56
7.8.3 RADIUS Typical Examples	57
7.8.4 RADIUS Troubleshooting	59
7.9 SSL	59
7.9.1 Introduction to SSL	59
7.9.2 SSL Configuration Task List	61
7.9.3 SSL Typical Example	62
7.9.4 SSL Troubleshooting	62
7.10 VLAN-ACL	63
7.10.1 Introduction to VLAN-ACL	63
7.10.2 VLAN-ACL Configuration Task List	63
7.10.3 VLAN-ACL Configuration Example	64
7.10.4 VLAN-ACL Troubleshooting	66
7.11 PPPoE INTERMEDIATE AGENT	66
7.11.1 Introduction to PPPoE Intermediate Agent	66
7.11.2 PPPoE Intermediate Agent Configuration Task List	70
7.11.3 PPPoE Intermediate Agent Typical Application	71

7.11.4 PPPoE Intermediate Agent Troubleshooting	73
7.12 QoS	73
7.12.1 QoS	73
7.12.2 PBR	87
7.12.3 IPv6 PBR	90
7.13 FLOW-BASED REDIRECTION	93
7.13.1 Introduction to Flow-based Redirection	93
7.13.2 Flow-based Redirection Configuration Task Sequence	93
7.13.3 Flow-based Redirection Examples	94
7.13.4 Flow-based Redirection Troubleshooting Help	94
7.14 EGRESS QoS	95
7.14.1 Introduction to Egress QoS	95
7.14.2 Egress QoS Configuration	97
7.14.3 Egress QoS Examples	101
7.14.4 Egress QoS Troubleshooting Help	102
7.15 FLEXIBLE QINQ	103
7.15.1 Introduction to Flexible QinQ	103
7.15.2 Flexible QinQ Configuration Task List	103
7.15.3 Flexible QinQ Example	105
7.15.4 Flexible QinQ Troubleshooting	106
7.16 CAPTIVE PORTAL AUTHENTICATION	1
7.16.1 Captive Portal Authentication Configuration	1
7.16.2 Accounting Function Configuration	5
7.16.3 Free-resource Configuration	8
7.16.4 Authentication White-list Configuration	9
7.16.5 Automatic Page Pushing after Successful Authentication (it is not supported currently)	10
7.16.6 http-redirect-filter	13
7.16.7 Portal Non-perception	15
7.16.8 Portal Escaping	18
7.17 MAB	24
7.17.1 Introduction to MAB	24
7.17.2 MAB Configuration Task List	25
7.17.3 MAB Example	26

7.17.4 MAB Troubleshooting	28
CHAPTER 8 RELIABILITY CONFIGURATION	30
8.1 MSTP	30
8.1.1 Introduction to MSTP	30
8.1.2 MSTP Configuration Task List	32
8.1.3 MSTP Example	35
8.1.4 MSTP Troubleshooting	40
8.2 VRRP	1
8.2.1 Introduction to VRRP	1
8.2.2 VRRP Configuration Task List	1
8.2.3 VRRP Typical Examples	3
8.2.4 VRRP Troubleshooting	4
8.3 MRPP	4
8.3.1 Introduction to MRPP	4
8.3.2 MRPP Configuration Task List	7
8.3.3 MRPP Typical Scenario	9
8.3.4 MRPP Troubleshooting	10
8.4 ULPP	11
8.4.1 Introduction to ULPP	11
8.4.2 ULPP Configuration Task List	13
8.4.3 ULPP Typical Examples	15
8.4.4 ULPP Troubleshooting	18
8.5 ULSM	18
8.5.1 Introduction to ULSM	18
8.5.2 ULSM Configuration Task List	19
8.5.3 ULSM Typical Example	20
8.5.4 ULSM Troubleshooting	21
8.6 ERPS	21
8.6.1 Introduction to ERPS	21
8.6.2 ERPS Configuration	28
8.6.3 ERPS Examples	30
8.6.4 ERPS Troubleshooting	48

CHAPTER 9 DEBUGGING AND DIAGNOSIS CONFIGURATION

9.1 MONITOR AND DEBUG	1
9.1.1 Ping	1
9.1.2 Ping6	1
9.1.3 Traceroute	1
9.1.4 Traceroute6	2
9.1.5 Show	2
9.1.6 Debug	3
9.2 RELOAD SWITCH AFTER SPECIFIED TIME	3
9.2.1 Introduce to Reload Switch after Specifid Time	3
9.2.2 Reload Switch after Specifid Time Task List	3
9.3 DEBUGGING AND DIAGNOSIS FOR PACKETS RECEIVED AND SENT BY CPU4	
9.3.1 Introduction to Debugging and Diagnosis for Packets Received and Sent by CPU	4
9.3.2 Debugging and Diagnosis for Packets Received and Sent by CPU Task List	4
9.4 INFO-CENTER	5
9.4.1 Overview	5
9.4.2 The content indicates the specific contents of the system information.Configure Sequence	8
9.4.3 Instructions	10
9.4.4 Erratum	13
9.5 MIRROR	1
9.5.1 Introduction to Mirror	1
9.5.2 Mirror Configuration Task List	1
9.5.3 Mirror Examples	2
9.5.4 Device Mirror Troubleshooting	3
9.6 RSPAN	3
9.6.1 Introduction to RSPAN	3
9.6.2 RSPAN Configuration Task List	5
9.6.3 Typical Examples of RSPAN	6
9.6.4 RSPAN Troubleshooting	9
9.7 ERSPAN	9

9.7.1 Introduction to ERSPAN	9
9.7.2 ERSPAN Configuration Task List	10
9.7.3 Typical Examples of ERSPAN	10
9.7.4 ERSPAN Troubleshooting	12
9.8 sFLOW	12
9.8.1 Introduction to sFlow	12
9.8.2 sFlow Configuration Task List	13
9.8.3 sFlow Examples	14
9.8.4 sFlow Troubleshooting	15
CHAPTER 10 NETWORK TIME MANAGEMENT	
CONFIGURATION	1
10.1 NTP	1
10.1.1 Introduction to NTP Function	1
10.1.2 NTP Function Configuration Task List	1
10.1.3 Typical Examples of NTP Function	4
10.1.4 NTP Function Troubleshooting	4
10.2 SNTP	5
10.2.1 Introduction to SNTP	5
10.2.2 Typical Examples of SNTP Configuration	6
10.3 DNSv4/v6	7
10.3.1 Introduction to DNS	7
10.3.2 DNSv4/v6 Configuration Task List	8
10.3.3 Typical Examples of DNS	10
10.3.4 DNS Troubleshooting	11
10.4 SUMMER TIME	11
10.4.1 Introduction to Summer Time	11
10.4.2 Summer Time Configuration Task Sequence	12
10.4.3 Examples of Summer Time	12
10.4.4 Summer Time Troubleshooting	12
CHAPTER 11 VSF CONFIGURATION	1
11.1 VSF	1

11.1.1 Overview	1
11.1.2 Relevant VSF Configuration	7
11.1.3 Typical VSF Example	10
11.1.4 VSF Troubleshooting	14
CHAPTER 12 DATACENTER CONFIGURATION	16
12.1 MC-LAG	16
12.1.1 Introduction to MC-LAG	16
12.1.2 Typical application	16
12.1.3 MC-LAG Configuration	18
12.1.4 Typical Application of MC-LAG	20
12.1.5 MC-LAG Troubleshooting Help	29
12.2 NETCONF	29
12.2.1 Introduction to NETCONF	29
12.2.2 NETCONF Configuration	31
12.2.3 NETCONF For Examples	32
12.2.4 NETCONF Troubleshooting Help	37
12.3 VXLAN&EVPN	37
12.3.1 VXLAN&EVPN Introduction	38
12.3.2 VXLAN&EVPN Configuration	41
12.3.3 Examples of VXLAN	47
12.3.4 VXLAN Troubleshooting	66
CHAPTER 13 IPV6 CONFIGURATION	1
13.1 DHCPv6	1
13.1.1 Introduction to DHCPv6	1
13.1.2 DHCPv6 Server Configuration	2
13.1.3 DHCPv6 Relay Delegation Configuration	3
13.1.4 DHCPv6 Prefix Delegation Server Configuration	4
13.1.5 DHCPv6 Prefix Delegation Client Configuration	5
13.1.6 DHCPv6 Configuration Examples	6
13.1.7 DHCPv6 Troubleshooting	9
13.2 DHCPV6 OPTION37, 38	10
13.2.1 Introduction to DHCPv6 option37, 38	10
13.2.2 DHCPv6 option37, 38 Configuration Task List	11

13.2.3 DHCPv6 option37, 38 Examples	15
13.2.4 DHCPv6 option37, 38 Troubleshooting	18
13.3 PREVENT ND SPOOFING	19
13.3.1 Overview	19
13.3.2 Prevent ND Spoofing configuration	19
13.3.3 Prevent ND Spoofing Example	20
13.4 RIPNG	20
13.4.1 Introduction to RIPng	20
13.4.2 RIPng Configuration Task List	21
13.4.3 RIPng Configuration Examples	25
13.4.4 RIPng Troubleshooting	28
13.5 OSPFv3	28
13.5.1 Introduction to OSPFv3	28
13.5.2 OSPFv3 Configuration Task List	31
13.5.3 OSPFv3 Examples	35
13.5.4 OSPFv3 Troubleshooting	38
13.6 MBGP4+	38
13.6.1 Introduction to MBGP4+	38
13.6.2 MBGP4+ Configuration Task List	38
13.6.3 MBGP4+ Examples	40
13.6.4 MBGP4+ Troubleshooting	41
13.7 IPV6 BLACK HOLE ROUTING	41
13.7.1 Introduction to Black Hole Routing	41
13.7.2 IPv6 Black Hole Routing Configuration Task	41
13.7.3 Black Hole Routing Configuration Exmaples	42
13.7.4 Black Hole Routing Troubleshooting	43
13.8 IPV6 MULTICAST PROTOCOL	43
13.8.1 PIM-DM6	43
13.8.2 PIM-SM6	48
13.8.3 ANYCAST RP v6	54
13.8.4 PIM-SSM6	59
13.8.5 IPv6 DCSCM	62
13.8.6 MLD	66
13.8.7 MLD Snooping	69

13.9 IPv6 SECURITY RA	1
13.9.1 Introduction to IPv6 Security RA	1
13.9.2 IPv6 Security RA Configuration Task Sequence	1
13.9.3 IPv6 Security RA Typical Examples	2
13.9.4 IPv6 Security RA Troubleshooting Help	2
13.10 SAVI CONFIGURATION	3
13.10.1 Introduction to SAVI	3
13.10.2 SAVI Configuration	3
13.10.3 SAVI Typical Application	6
13.10.4 SAVI Troubleshooting	8
13.11 IPv6 VRRPv3	8
13.11.1 Introduction to VRRPv3	8
13.11.2 VRRPv3 Configuration	11
13.11.3 VRRPv3 Typical Examples	12
13.11.4 VRRPv3 Troubleshooting	14
CHAPTER 14 POE CONFIGURATION	15
14.1 POE	15
14.1.1 Introduction to PoE	15
14.1.2 PoE Configuration	15
14.1.3 Typical Application of PoE	17
14.1.4 PoE Troubleshooting Help	18

Chapter 1 Basic Management Configuration

1.1 Switch Management

1.1.1 Management Options

After purchasing the switch, the user needs to configure the switch for network management. Switch provides two management options: in-band management and out-of-band management.

1.1.1.1 Out-Of-Band Management

Out-of-band management is the management through Console interface. Generally, the user will use out-of-band management for the initial switch configuration, or when in-band management is not available. For instance, the user must assign an IP address to the switch via the Console interface to be able to access the switch through Telnet.

The procedures for managing the switch via Console interface are listed below:

Step 1: setting up the environment:

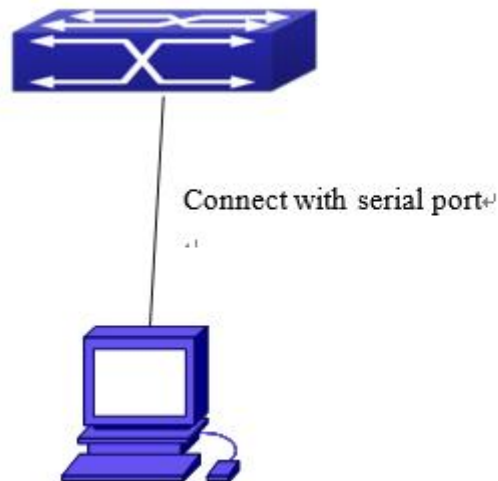

Figure 1-1 Out-of-band Management Configuration Environment

As shown in above, the serial port (RS-232) is connected to the switch with the serial cable provided. The table below lists all the devices used in the connection.

Device Name	Description
PC machine	Has functional keyboard and RS-232, with terminal emulator installed, such as HyperTerminal included in Windows

	9x/NT/2000/XP.
Serial port cable	One end attach to the RS-232 serial port, the other end to the Console port.
Switch	Functional Console port required.

Step 2: Entering the HyperTerminal

Open the HyperTerminal included in Windows after the connection established. The example below is based on the HyperTerminal included in Windows XP.

- 1) Click Start menu - All Programs -Accessories -Communication - HyperTerminal.

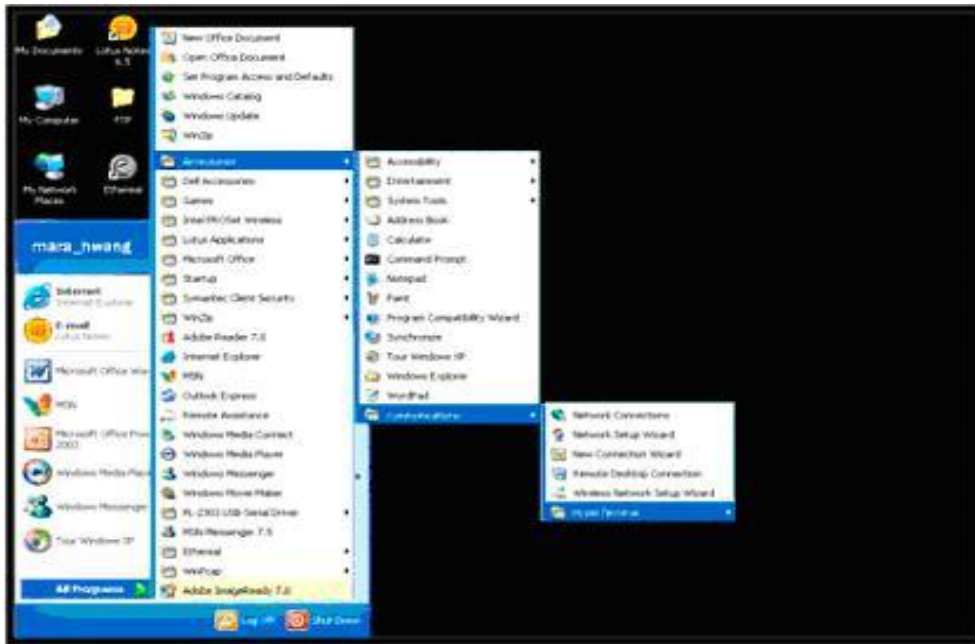

Fig 1-2 Opening Hyper Terminal

- 2) Type a name for opening HyperTerminal, such as “Switch”.



Figure 1-2 Opening HyperTerminal

- 3) In the “Connecting using” drop-list, select the RS-232 serial port used by the PC, e.g. COM1, and click “OK”.



Figure 1-3 Opening HyperTerminal

4) COM1 property appears, select “115200” for “Baud rate”, “8” for “Data bits”, “none” for “Parity checksum”, “1” for stop bit and “none” for traffic control; or, you can also click “Restore default” and click “OK”.

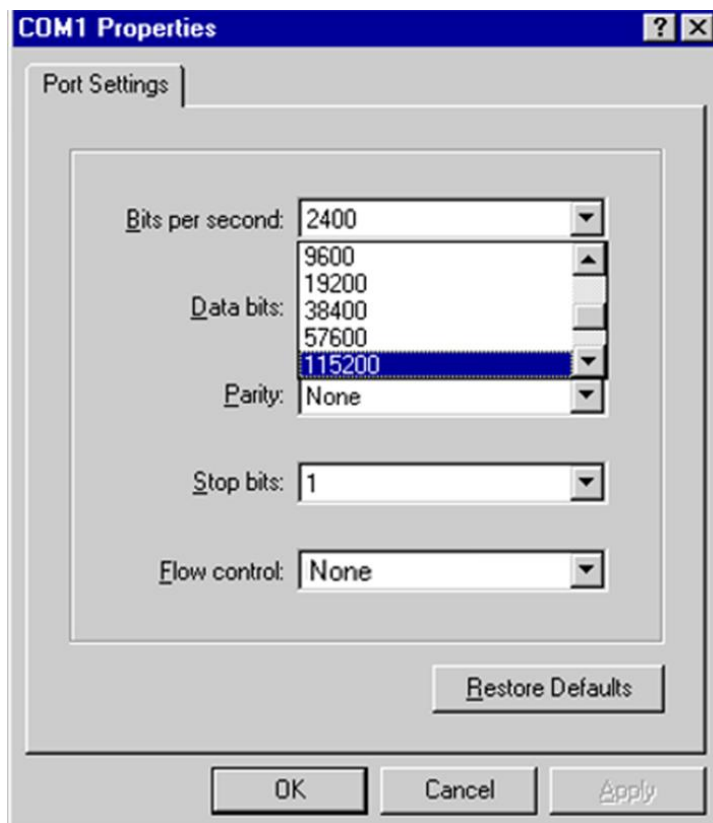

Figure 1-4 Opening HyperTerminal

Step 3: Entering switch CLI interface

Power on the switch, the following appears in the HyperTerminal windows, that is the CLI configuration mode for Switch.

```
Testing RAM...
0x077C0000 RAM OK
Loading MiniBootROM...
```

```
Attaching to file system ...

Loading nos.img ... done.
Booting.....
Starting at 0x10000...

Attaching to file system ...
.....

--- Performing Power-On Self Tests (POST) ---
DRAM Test.....PASS!
PCI Device 1 Test.....PASS!
FLASH Test.....PASS!
FAN Test.....PASS!
Done All Pass.
----- DONE -----
Current time is SUN JAN 01 00:00:00 2006
.....
Switch>
```

The user can now enter commands to manage the switch. For a detailed description for the commands, please refer to the following chapters.

1.1.1.2 In-band Management

In-band management refers to the management by login to the switch using Telnet, or using HTTP, or using SNMP management software to configure the switch. In-band management enables management of the switch for some devices attached to the switch. In the case when in-band management fails due to switch configuration changes, out-of-band management can be used for configuring and managing the switch.

1.1.1.2.1 Management via Telnet

To manage the switch with Telnet, the following conditions should be met:

- 1) Switch has an IPv4/IPv6 address configured;
- 2) The host IP address (Telnet client) and the switch's VLAN interface IPv4/IPv6 address is in the same network segment;
- 3) If 2) is not met, Telnet client can connect to an IPv4/IPv6 address of the switch via other devices, such as a router.

The switch is a Layer 3 switch that can be configured with several IPv4/IPv6 addresses, the configuration method refers to the relative chapter. The following example assumes the shipment status of the switch where only VLAN1 exists in the system.

The following describes the steps for a Telnet client to connect to the switch's VLAN1 interface by Telnet(IPV4 address example):

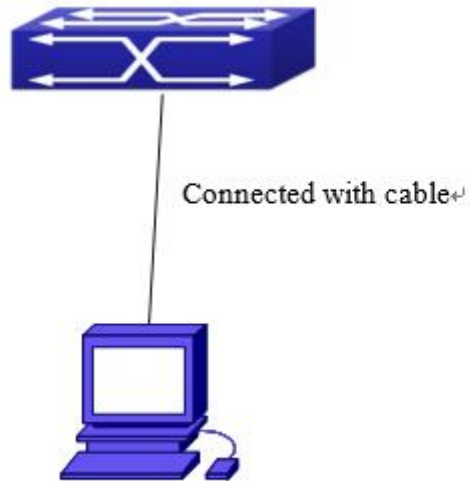

Figure 1-5 Manage the switch by Telnet

Step 1: Configure the IP addresses for the switch and start the Telnet Server function on the switch.

First is the configuration of host IP address. This should be within the same network segment as the switch VLAN1 interface IP address. Suppose the switch VLAN1 interface IP address is 10.1.128.251/24. Then, a possible host IP address is 10.1.128.252/24. Run “ping 10.1.128.251” from the host and verify the result, check for reasons if ping failed.

The IP address configuration commands for VLAN1 interface are listed below. Before in-band management, the switch must be configured with an IP address by out-of-band management (i.e. Console mode), the configuration commands are as follows (All switch configuration prompts are assumed to be “Switch” hereafter if not otherwise specified):

```
Switch>
Switch>enable
Switch#config
Switch(config)#interface vlan 1
Switch(Config-if-Vlan1)#ip address 10.1.128.251 255.255.255.0
Switch(Config-if-Vlan1)#no shutdown
```

To enable the Telnet Server function, users should type the CLI command telnet-server enable in the global mode as below:

```
Switch>enable
Switch#config
Switch(config)# telnet-server enable
```

Step 2: Run Telnet Client program.

Run Telnet client program included in Windows with the specified Telnet target.

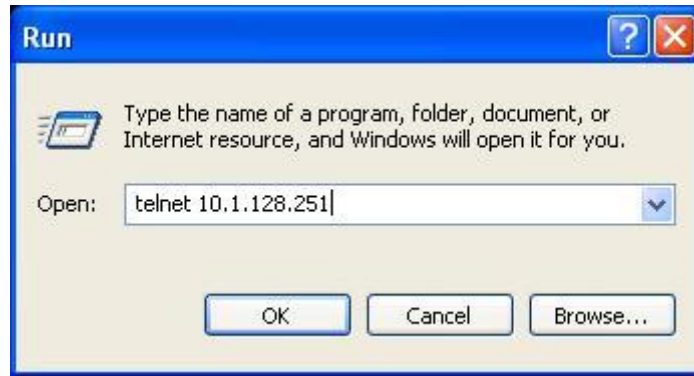

Figure 1-6 Run telnet client program included in Windows

Step 3: Login to the switch.

Login to the Telnet configuration interface. Valid login name and password are required, otherwise the switch will reject Telnet access. This is a method to protect the switch from unauthorized access. As a result, when Telnet is enabled for configuring and managing the switch, username and password for authorized Telnet users must be configured with the following command: `username <username> privilege <privilege> [password (0|7) <password>]`. To open the local authentication style with the following command: `authentication line vty login local`. Privilege option must exist and just is 15. Assume an authorized user in the switch has a username of “test”, and password of “test”, the configuration procedure should like the following:

```
Switch>enable
```

```
Switch#config
```

```
Switch(config)#username test privilege 15 password 0 test
```

```
Switch(config)#authentication line vty login local
```

Enter valid login name and password in the Telnet configuration interface, Telnet user will be able to enter the switch’s CLI configuration interface. The commands used in the Telnet CLI interface after login is the same as that in the Console interface.

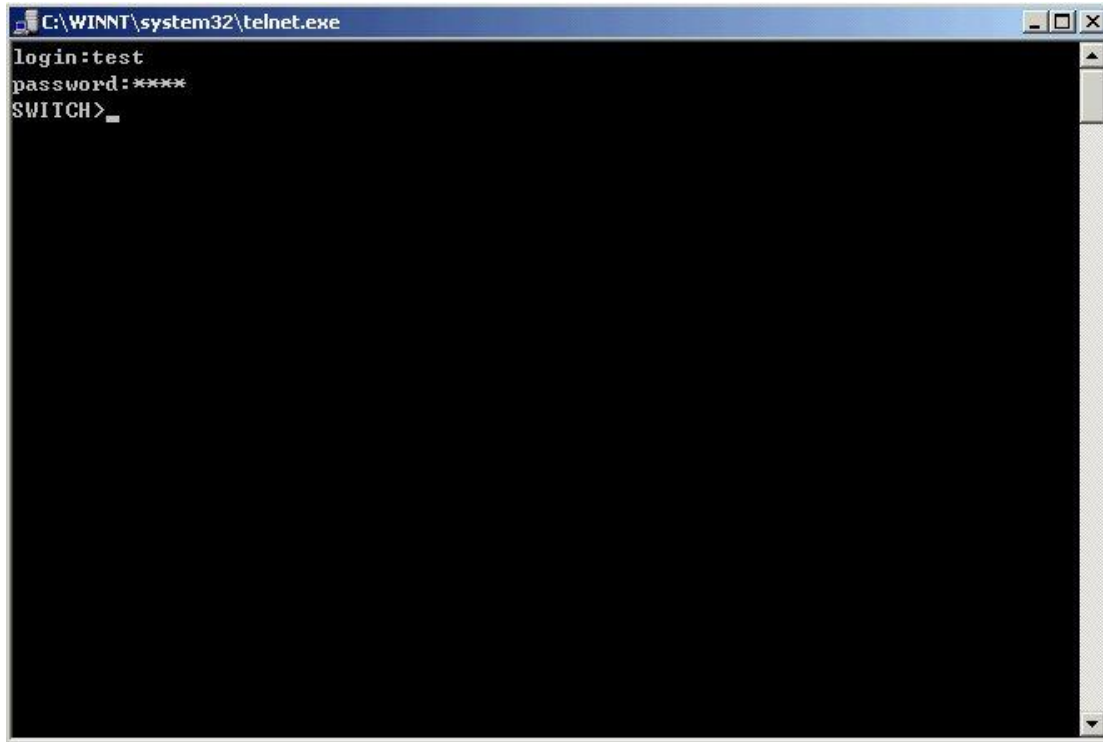

Figure 1-7 Telnet Configuration Interface

1.1.1.2.2 Management via HTTP

To manage the switch via HTTP, the following conditions should be met:

- 1) Switch has an IPv4/IPv6 address configured;
- 2) The host IPv4/IPv6 address (HTTP client) and the switch's VLAN interface IPv4/IPv6 address are in the same network segment;
- 3) If 2) is not met, HTTP client should connect to an IPv4/IPv6 address of the switch via other devices, such as a router.

Similar to management the switch via Telnet, as soon as the host succeeds to ping/ping6 an IPv4/IPv6 address of the switch and to type the right login password, it can access the switch via HTTP. The configuration list is as below:

Step 1: Configure the IP addresses for the switch and start the HTTP server function on the switch.

For configuring the IP address on the switch through out-of-band management, see the telnet management chapter.

To enable the WEB configuration, users should type the CLI command `IP http server` in the global mode as below:

```
Switch>enable
Switch#config
Switch(config)#ip http server
```

Step 2: Run HTTP protocol on the host.

Open the Web browser on the host and type the IP address of the switch, or run directly the HTTP protocol on the Windows. For example, the IP address of the switch is “10.1.128.251”;

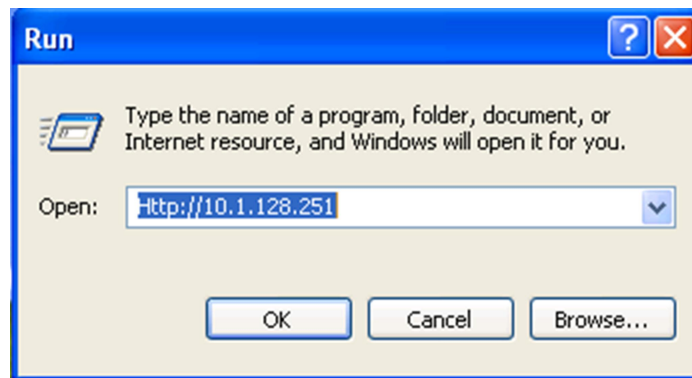

Figure 1-8 Run HTTP Protocol

When accessing a switch with IPv6 address, it is recommended to use the Firefox browser with 1.5 or later version. For example, if the IPv6 address of the switch is 3ffe:506:1:2::3. Input the IPv6 address of the switch is `http://[3ffe:506:1:2::3]` and the address should draw together with the square brackets.

Step 3: Login to the switch.

Login to the Web configuration interface. Valid login name and password are required, otherwise the switch will reject HTTP access. This is a method to protect the switch from unauthorized access. As a result, when Telnet is enabled for configuring and managing the switch, username and password for authorized Telnet users must be configured with the following command: **username <username> privilege <privilege> [password (0|7) <password>]**. To open the local authentication style with the following command: **authentication line web login local**. **Privilege** option must exist and just is 15. Assume an authorized user in the switch has a username of “admin”, and password of “admin”, the configuration procedure should like the following:

```
Switch>enable
```

```
Switch#config
```

```
Switch(config)#username admin privilege 15 password 0 admin
```

```
Switch(config)#authentication line web login local
```

The Web login interface of S400X-24FC-2AC is as below:

Welcome To Login Web Management System

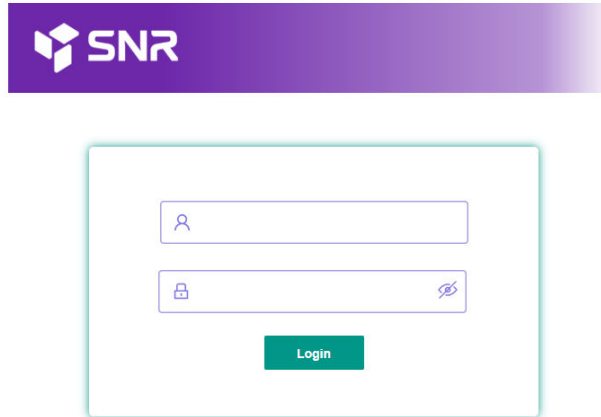

Figure 1-9 Web Login Interface

Input the right username and password, and then the main Web configuration interface is shown as below.

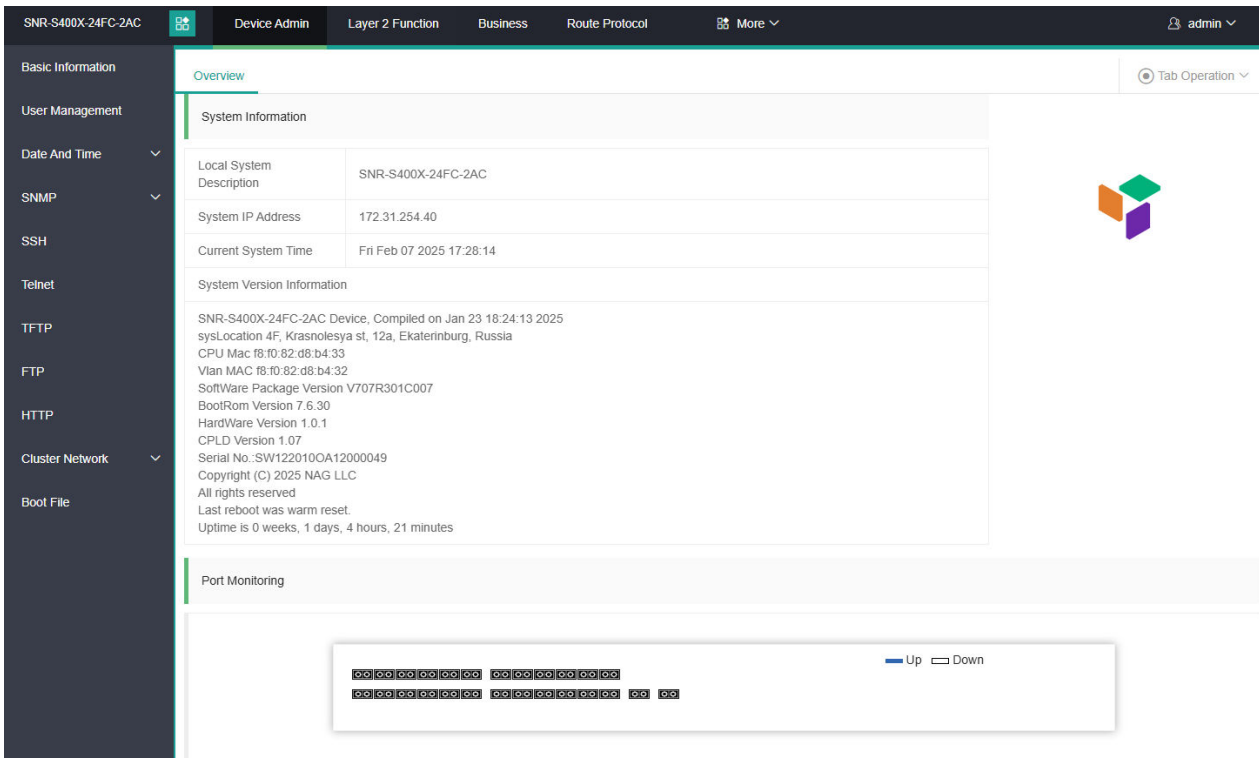

Figure 1- 10 Main Web Configuration Interface

Notice: When configure the switch, the name of the switch is composed with English letters.

1.1.1.2.3 Manage the Switch via SNMP Network Management

Software

The necessities required by SNMP network management software to manage switches:

- 1) IP addresses are configured on the switch;
- 2) The IP address of the client host and that of the VLAN interface on the switch it subordinates to should be in the same segment;
- 3) If 2) is not met, the client should be able to reach an IP address of the switch through devices like routers;
- 4) SNMP should be enabled.

The host with SNMP network management software should be able to ping the IP address of the switch, so that, when running, SNMP network management software will be able to find it and implement read/write operation on it. Details about how to manage switches via SNMP network management software will not be covered in this manual, please refer to “Snmp network management software user manual”.

1.1.2 CLI Interface

The switch provides three management interfaces for users: CLI (Command Line Interface) interface, Web interface, Snmp network management software. We will introduce the CLI interface and Web configuration interface in details, Web interface is familiar with CLI interface function and will not be covered, please refer to “Snmp network management software user manual”.

CLI interface is familiar to most users. As aforementioned, out-of-band management and Telnet login are all performed through CLI interface to manage the switch.

CLI Interface is supported by Shell program, which consists of a set of configuration commands. Those commands are categorized according to their functions in switch configuration and management. Each category represents a different configuration mode. The Shell for the switch is described below:

- 👉 Configuration Modes
- 👉 Configuration Syntax
- 👉 Shortcut keys
- 👉 Help function
- 👉 Input verification
- 👉 Fuzzy match support

1.1.2.1 Configuration Modes

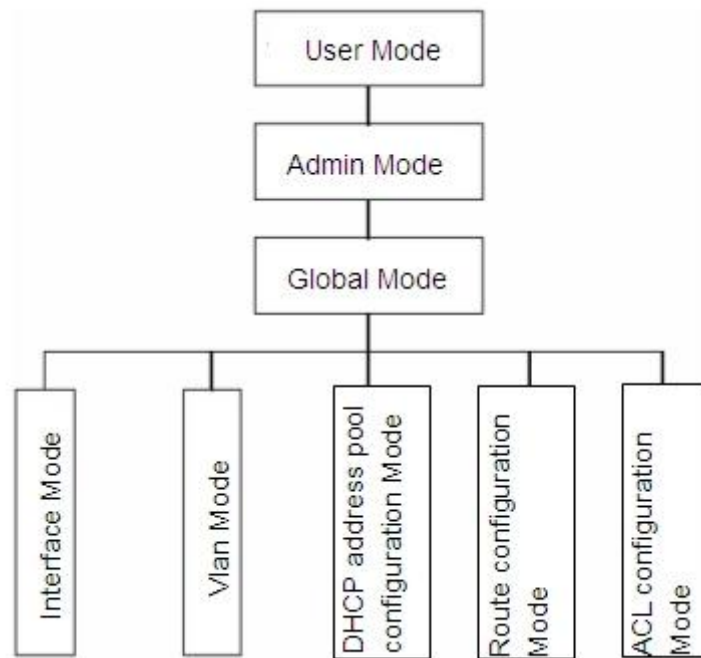

Figure 1- 11 Shell Configuration Modes

1.1.2.1.1 User Mode

On entering the CLI interface, entering user entry system first. If as common user, it is defaulted to User Mode. The prompt shown is “Switch>”, the symbol “>” is the prompt for User Mode. When exit command is run under Admin Mode, it will also return to the User Mode.

Under User Mode, no configuration to the switch is allowed, only clock time and version information of the switch can be queries.

1.1.2.1.2 Admin Mode

To Admin Mode sees the following: In user entry system, if as Admin user, it is defaulted to Admin Mode. Admin Mode prompt “Switch#” can be entered under the User Mode by running the enable command and entering corresponding access levels admin user password, if a password has been set. Or, when exit command is run under Global Mode, it will also return to the Admin Mode. Switch also provides a shortcut key sequence “Ctrl+z”, this allows an easy way to exit to Admin Mode from any configuration mode (except User Mode).

Under Admin Mode, the user can query the switch configuration information, connection status and traffic statistics of all ports; and the user can further enter the Global Mode from Admin Mode to modify all configurations of the switch. For this reason, a password must be set for entering Admin mode to prevent unauthorized access and malicious modification to the switch.

1.1.2.1.3 Global Mode

Type the config command under Admin Mode will enter the Global Mode prompt “Switch(config)#”. Use the exit command under other configuration modes such as Port Mode,

VLAN mode will return to Global Mode.

The user can perform global configuration settings under Global Mode, such as MAC Table, Port Mirroring, VLAN creation, IGMP Snooping start and STP, etc. And the user can go further to Port Mode for configuration of all the interfaces.

Interface Mode

Use the interface command under Global Mode can enter the interface mode specified. Switch provides three interface type: 1. VLAN interface; 2. Ethernet port; 3. port-channel, accordingly the three interface configuration modes.

Interface Type	Entry	Operates	Exit
VLAN Interface	Type interface vlan <Vlan-id> command under Global Mode.	Configure switch IPs, etc	Use the exit command to return to Global Mode.
Ethernet Port	Type interface ethernet <interface-list> command under Global Mode.	Configure supported duplex mode, speed, etc. of Ethernet Port.	Use the exit command to return to Global Mode.
port-channel	Type interface port-channel <port-channel-number> command under Global Mode.	Configure port-channel related settings such as duplex mode, speed, etc.	Use the exit command to return to Global Mode.

VLAN Mode

Using the `vlan <vlan-id>` command under Global Mode can enter the corresponding VLAN Mode. Under VLAN Mode the user can configure all member ports of the corresponding VLAN. Run the `exit` command to exit the VLAN Mode to Global Mode.

DHCP Address Pool Mode

Type the `ip dhcp pool <name>` command under Global Mode will enter the DHCP Address Pool Mode prompt “Switch(Config-<name>-dhcp)#”. DHCP address pool properties can be configured under DHCP Address Pool Mode. Run the `exit` command to exit the DHCP Address Pool Mode to Global Mode.

Route Mode

Routing Protocol	Entry	Operates	Exit
RIP Routing Protocol	Type router rip command under Global Mode.	Configure RIP protocol parameters.	Use the exit command to return to Global Mode.
OSPF Routing Protocol	Type router ospf command under Global Mode.	Configure OSPF protocol parameters.	Use the exit command to return to Global Mode.
BGP Routing Protocol	Type router bgp <AS number>	Configure BGP protocol parameters.	Use the exit command to return to Global

	command under Global Mode.		Mode.
--	----------------------------	--	-------

ACL Mode

ACL type	Entry	Operates	Exit
Standard IP ACL Mode	Type ip access-list standard command under Global Mode.	Configure parameters for Standard IP ACL Mode.	Use the exit command to return to Global Mode.
Extended IP ACL Mode	Type ip access-list extended command under Global Mode.	Configure parameters for Extended IP ACL Mode.	Use the exit command to return to Global Mode.

1.1.2.2 Configuration Syntax

Switch provides various configuration commands. Although all the commands are different, they all abide by the syntax for Switch configuration commands. The general commands format of Switch is shown below:

cmdtxt <variable> {enum1 | ... | enumN} [option1 | ... | optionN]

Conventions: **cmdtxt** in bold font indicates a command keyword; <variable> indicates a variable parameter; {enum1 | ... | enumN} indicates a mandatory parameter that should be selected from the parameter set enum1~enumN; and the square bracket ([]) in [option1 | ... | optionN] indicate an optional parameter. There may be combinations of "< >", "{ }" and "[]" in the command line, such as [**variable**], {enum1 <variable>| enum2}, [option1 [option2]], etc.

Here are examples for some actual configuration commands:

- ☞ show version, no parameters required. This is a command with only a keyword and no parameter, just type in the command to run.
- ☞ vlan <vlan-id>, parameter values are required after the keyword.
- ☞ firewall {enable | disable}, user can enter firewall enable or firewall disable for this command.
- ☞ snmp-server community {ro | rw} <string>, the followings are possible:
snmp-server community ro <string>
snmp-server community rw <string>

1.1.2.3 Shortcut Key Support

Switch provides several shortcut keys to facilitate user configuration, such as up, down, left, right and Blank Space. If the terminal does not recognize Up and Down keys, ctrl +p and ctrl +n can be used instead.

Key(s)	Function
Back Space	Delete a character before the cursor, and the cursor moves back.
Up "↑"	Show previous command entered. Up to ten recently entered commands can be shown.

Down “↓”	Show next command entered. When use the Up key to get previously entered commands, you can use the Down key to return to the next command	
Left “←”	The cursor moves one character to the left.	You can use the Left and Right key to modify an entered command.
Right “→”	The cursor moves one character to the right.	
Ctrl +p	The same as Up key “↑”.	
Ctrl +n	The same as Down key “↓”.	
Ctrl +b	The same as Left key “←”.	
Ctrl +f	The same as Right key “→”.	
Ctrl +z	Return to the Admin Mode directly from the other configuration modes (except User Mode).	
Ctrl +c	Break the ongoing command process, such as ping or other command execution.	
Tab	When a string for a command or keyword is entered, the Tab can be used to complete the command or keyword if there is no conflict.	

1.1.2.4 Help Function

There are two ways in Switch for the user to access help information: the “help” command and the “?”.

Access to Help	Usage and function
Help	Under any command line prompt, type in “help” and press Enter will get a brief description of the associated help system.
“?”	<ol style="list-style-type: none"> Under any command line prompt, enter “?” to get a command list of the current mode and related brief description. Enter a “?” after the command keyword with an embedded space. If the position should be a parameter, a description of that parameter type, scope, etc, will be returned; if the position should be a keyword, then a set of keywords with brief description will be returned; if the output is “<cr>“, then the command is complete, press Enter to run the command. A “?” immediately following a string. This will display all the commands that begin with that string.

1.1.2.5 Input Verification

1.1.2.5.1 Returned Information: success

All commands entered through keyboards undergo syntax check by the Shell. Nothing will be returned if the user entered a correct command under corresponding modes and the execution is successful.

1.1.2.5.2 Returned Information: error

When the command entered by the user is incorrect, or there are errors in the parameter range, type, or format, the switch will prompt an error message.

1.1.2.5.3 Fuzzy Match Support

Switch shell support fuzzy match in searching command and keyword. Shell will recognize commands or keywords correctly if the entered string causes no conflict.

For example:

- 1) For command “show interfaces status ethernet1/0/1”, typing “sh in status ethernet1/0/1” will work.
- 2) However, for command “show running-config”, the system will report a “> Ambiguous command!” error if only “show r” is entered, as Shell is unable to tell whether it is “show run” or “show running-config”. Therefore, Shell will only recognize the command if “sh ru” is entered.

1.2 Basic Switch Configuration

1.2.1 Basic Configuration

Basic switch configuration includes commands for entering and exiting the admin mode, commands for entering and exiting interface mode, for configuring and displaying the switch clock, for displaying the version information of the switch system, etc.

Command	Explanation
Normal User Mode/ Admin Mode	
enable [<1-15> disable	The User uses enable command to step into admin mode from normal user mode or modify the privilege level of the users. The disable command is for exiting admin mode.
Admin Mode	
config [terminal]	Enter global mode from admin mode.
Various Modes	
exit	Exit current mode and enter previous mode, such as using this command in global mode to go back to admin mode, and back to normal user mode from admin mode.

show privilege	Show privilege of the current users.
Except User Mode/ Admin Mode	
end	Quit current mode and return to Admin mode when not at User Mode/ Admin Mode.
Admin Mode	
clock set <HH:MM:SS> [YYYY.MM.DD]	Set system date and time.
show version	Display version information of the switch.
set default	Restore to the factory default.
write	Save current configuration parameters to Flash Memory.
reload	Hot reset the switch.
show cpu usage	Show CPU usage rate.
show cpu utilization	Show current CPU utilization rate.
show memory usage	Show memory usage rate.
Global Mode	
banner motd <LINE> no banner motd	Configure the information displayed when the login authentication of a telnet or console user is successful.
web-auth privilege <1-15> no web-auth privilege	Configure the level of logging in the switch by web.

1.2.2 Telnet Management

1.2.2.1 Telnet

1.2.2.1.1 Introduction to Telnet

Telnet is a simple remote terminal protocol for remote login. Using Telnet, the user can login to a remote host with its IP address or hostname from his own workstation. Telnet can send the user's keystrokes to the remote host and send the remote host output to the user's screen through TCP connection. This is a transparent service, as to the user, the keyboard and monitor seems to be connected to the remote host directly.

Telnet employs the Client-Server mode, the local system is the Telnet client and the remote host is the Telnet server. Switch can be either the Telnet Server or the Telnet client.

When switch is used as the Telnet server, the user can use the Telnet client program included in Windows or the other operation systems to login to switch, as described earlier in the In-band management section. As a Telnet server, switch allows up to 5 telnet client TCP connections.

And as Telnet client, using telnet command under Admin Mode allows the user to login to the other remote hosts. Switch can only establish TCP connection to one remote host. If a connection to another remote host is desired, the current TCP connection must be dropped.

1.2.2.1.2 Telnet Configuration Task List

1. Configure Telnet Server
2. Telnet to a remote host from the switch.

1. Configure Telnet Server

Command	Explanation
Global Mode	
telnet-server enable no telnet-server enable	Enable the Telnet server function in the switch: the no command disables the Telnet function.
username <user-name> [privilege <privilege>] [password [0 7] <password>] no username <username>	Configure user name and password of the telnet. The no form command deletes the telnet user authorization.
aaa authorization config-commands no aaa authorization config-commands	Enable command authorization function for the login user with VTY (login with Telnet and SSH). The no command disables this function. Only enabling this command and configuring command authorization manner, it will request to authorize when executing some command.
authentication securityip <ip-addr> no authentication securityip <ip-addr>	Configure the secure IP address to login to the switch through Telnet: the no command deletes the authorized Telnet secure address.
authentication securityipv6 <ipv6-addr> no authentication securityipv6 <ipv6-addr>	Configure IPv6 security address to login to the switch through Telnet; the no command deletes the authorized Telnet security address.
authentication ip access-class {<num-std> <name>} no authentication ip access-class	Binding standard IP ACL protocol to login with Telnet/SSH/Web; the no form command will cancel the binding ACL.
authentication ipv6 access-class {<num-std> <name>} in no authentication ipv6 access-class	Binding standard IPv6 ACL protocol to login with Telnet/SSH/Web; the no form command will cancel the binding ACL.
authentication line {console vty web} login method1 [method2 ...] no authentication line {console vty web} login	Configure authentication method list with telnet.
authentication enable method1 [method2 ...] no authentication enable	Configure the enable authentication method list.
authorization line {console vty web} exec method1 [method2 ...]	Configure the authorization method list with telnet.

no authorization line {console vty web} exec	
authorization line vty command <1-15> {local radius tacacs} (none) no authorization line vty command <1-15>	Configure command authorization manner and authorization selection priority of login user with VTY (login with Telnet and SSH). The no command recovers to be default manner.
accounting line {console vty} command <1-15> {start-stop stop-only none} method1 [method2...] no accounting line {console vty} command <1-15>	Configure the accounting method list.
Admin Mode	
terminal monitor terminal no monitor	Display debug information for Telnet client login to the switch; the no command disables the debug information.
show users	Show the user information who logs in through telnet or ssh. It includes line number, user name and user IP.
clear line vty <0-31>	Delete the logged user information on the appointed line, force user to get down the line who logs in through telnet or ssh.

2. Telnet to a remote host from the switch

Command	Explanation
Admin Mode	
telnet [vrf <vrf-name>] {<ip-addr> <ip6-addr> host <hostname>} [<port>]	Login to a remote host with the Telnet client included in the switch.

1.2.2.2 SSH

1.2.2.2.1 Introduction to SSH

SSH (Secure Shell) is a protocol which ensures a secure remote access connection to network devices. It is based on the reliable TCP/IP protocol. By conducting the mechanism such as key distribution, authentication and encryption between SSH server and SSH client, a secure connection is established. The information transferred on this connection is protected from being intercepted and decrypted. The switch meets the requirements of SSH2.0. It supports SSH2.0 client software such as SSH Secure Client and putty. Users can run the above software to manage the switch remotely.

The switch presently supports RSA authentication, 3DES cryptography protocol and SSH user password authentication etc.

1.2.2.2.2 SSH Server Configuration Task List

Command	Explanation
Global Mode	
ssh-server enable no ssh-server enable	Enable SSH function on the switch; the no command disables SSH function.
username <username> [privilege <privilege>] [password [0 7] <password>] no username <username>	Configure the username and password of SSH client software for logging on the switch; the no command deletes the username.
ssh-server timeout <timeout> no ssh-server timeout	Configure timeout value for SSH authentication; the no command restores the default timeout value for SSH authentication.
ssh-server authentication-retries <authentication-retries> no ssh-server authentication-retries	Configure the number of times for retrying SSH authentication; the no command restores the default number of times for retrying SSH authentication.
ssh-server host-key create rsa modulus <moduls>	Generate the new RSA host key on the SSH server.
Admin Mode	
terminal monitor terminal no monitor	Display SSH debug information on the SSH client side; the no command stops displaying SSH debug information on the SSH client side.
show crypto key	Show the secret key of ssh.
crypto key clear rsa	Clear the secret key of ssh.

1.2.2.2.3 Example of SSH Server Configuration

Example1:

Requirement: Enable SSH server on the switch, and run SSH2.0 client software such as Secure shell client or putty on the terminal. Log on the switch by using the username and password from the client.

Configure the IP address, add SSH user and enable SSH service on the switch. SSH2.0 client can log on the switch by using the username and password to configure the switch.

```
Switch(config)#ssh-server enable
```

```
Switch(config)#interface vlan 1
```

```
Switch(Config-if-Vlan1)#ip address 100.100.100.200 255.255.255.0
```

```
Switch(Config-if-Vlan1)#exit
```

```
Switch(config)#username test privilege 15 password 0 test
```

In IPv6 networks, the terminal should run SSH client software which support IPv6, such as putty6. Users should not modify the configuration of the switch except allocating an IPv6 address for the local host.

1.2.3 Configure Switch IP Addresses

All Ethernet ports of switch are default to Data Link layer ports and perform layer 2 forwarding. VLAN interface represent a Layer 3 interface function which can be assigned an IP address, which is also the IP address of the switch. All VLAN interface related configuration commands can be configured under VLAN Mode. Switch provides three IP address configuration methods:

- 👉 Manual
- 👉 BOOTP
- 👉 DHCP

Manual configuration of IP address is assign an IP address manually for the switch.

In BOOTP/DHCP mode, the switch operates as a BOOTP/DHCP client, send broadcast packets of BOOTPRequest to the BOOTP/DHCP servers, and the BOOTP/DHCP servers assign the address on receiving the request. In addition, switch can act as a DHCP server, and dynamically assign network parameters such as IP addresses, gateway addresses and DNS server addresses to DHCP clients DHCP Server configuration is detailed in later chapters.

1.2.3.1 Switch IP Addresses Configuration Task List

1. Enable VLAN port mode
2. Manual configuration
3. BOOTP configuration
4. DHCP configuration

1. Enable VLAN port mode

Command	Explanation
Global Mode	
interface vlan <vlan-id> no interface vlan <vlan-id>	Create VLAN interface (layer 3 interface); the no command deletes the VLAN interface.

2. Manual configuration

Command	Explanation
VLAN Interface Mode	
ip address <ip_address> <mask> [secondary] no ip address <ip_address> <mask> [secondary]	Configure IP address of VLAN interface; the no command deletes IP address of VLAN interface.
ipv6 address <ipv6-address / prefix-length> [eui-64] no ipv6 address <ipv6-address / prefix-length>	Configure IPv6 address, including aggregation global unicast address, local site address and local link address. The no command deletes IPv6 address.

3. BOOTP configuration

Command	Explanation
VLAN Interface Mode	
ip bootp-client enable no ip bootp-client enable	Enable the switch to be a BootP client and obtain IP address and gateway address through BootP negotiation; the no command disables the BootP client function.

4. DHCP configuration

Command	Explanation
VLAN Interface Mode	
ip bootp-client enable no ip bootp-client enable	Enable the switch to be a DHCP client and obtain IP address and gateway address through DHCP negotiation; the no command disables the DHCP client function.

1.2.4 SNMP Configuration

1.2.4.1 Introduction to SNMP

SNMP (Simple Network Management Protocol) is a standard network management protocol widely used in computer network management. SNMP is an evolving protocol. SNMP v1 [RFC1157] is the first version of SNMP which is adapted by vast numbers of manufacturers for its simplicity and easy implementation; SNMP v2c is an enhanced version of SNMP v1, which supports layered network management; SNMP v3 strengthens the security by adding USM (User-based Security Mode) and VACM (View-based Access Control Model).

SNMP protocol provides a simple way of exchange network management information between two points in the network. SNMP employs a polling mechanism of message query, and transmits messages through UDP (a connectionless transport layer protocol). Therefore it is well supported by the existing computer networks.

SNMP protocol employs a station-agent mode. There are two parts in this structure: NMS (Network Management Station) and Agent. NMS is the workstation on which SNMP client program is running. It is the core on the SNMP network management. Agent is the server software runs on the devices which need to be managed. NMS manages all the managed objects through Agents. The switch supports Agent function.

The communication between NMS and Agent functions in Client/Server mode by exchanging standard messages. NMS sends request and the Agent responds. There are seven types of SNMP message:

- 👉 Get-Request
- 👉 Get-Response
- 👉 Get-Next-Request

- 👉 Get-Bulk-Request
- 👉 Set-Request
- 👉 Trap
- 👉 Inform-Request

NMS sends queries to the Agent with Get-Request, Get-Next-Request, Get-Bulk-Request and Set-Request messages; and the Agent, upon receiving the requests, replies with Get-Response message. On some special situations, like network device ports are on Up/Down status or the network topology changes, Agents can send Trap messages to NMS to inform the abnormal events. Besides, NMS can also be set to alert to some abnormal events by enabling RMON function. When alert events are triggered, Agents will send Trap messages or log the event according to the settings. Inform-Request is mainly used for inter-NMS communication in the layered network management.

USM ensures the transfer security by well-designed encryption and authentication. USM encrypts the messages according to the user typed password. This mechanism ensures that the messages can't be viewed on transmission. And USM authentication ensures that the messages can't be changed on transmission. USM employs DES-CBC cryptography. And HMAC-MD5 and HMAC-SHA are used for authentication.

VACM is used to classify the users' access permission. It puts the users with the same access permission in the same group. Users can't conduct the operation which is not authorized.

1.2.4.2 Introduction to MIB

The network management information accessed by NMS is well defined and organized in a Management Information Base (MIB). MIB is pre-defined information which can be accessed by network management protocols. It is in layered and structured form. The pre-defined management information can be obtained from monitored network devices. ISO ASN.1 defines a tree structure for MID. Each MIB organizes all the available information with this tree structure. And each node on this tree contains an OID (Object Identifier) and a brief description about the node. OID is a set of integers divided by periods. It identifies the node and can be used to locate the node in a MID tree structure, shown in the figure below:

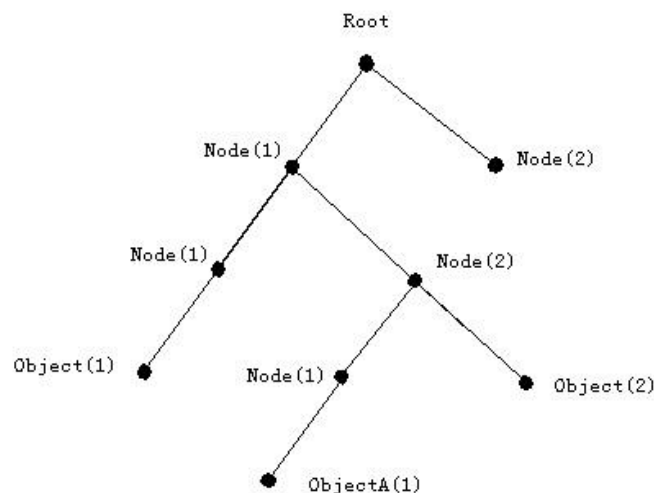

Figure 1- 12 ASN.1 Tree Instance

In this figure, the OID of the object A is 1.2.1.1. NMS can locate this object through this unique OID and gets the standard variables of the object. MIB defines a set of standard variables for monitored network devices by following this structure.

If the variable information of Agent MIB needs to be browsed, the MIB browse software needs to be run on the NMS. MIB in the Agent usually consists of public MIB and private MIB. The public MIB contains public network management information that can be accessed by all NMS; private MIB contains specific information which can be viewed and controlled by the support of the manufacturers.

MIB-I [RFC1156] is the first implemented public MIB of SNMP, and is replaced by MIB-II [RFC1213]. MIB-II expands MIB-I and keeps the OID of MIB tree in MIB-I. MIB-II contains sub-trees which are called groups. Objects in those groups cover all the functional domains in network management. NMS obtains the network management information by visiting the MIB of SNMP Agent.

The switch can operate as a SNMP Agent, and supports both SNMP v1/v2c and SNMP v3. The switch supports basic MIB-II, RMON public MIB and other public MID such as BRIDGE MIB. Besides, the switch supports self-defined private MIB.

1.2.4.3 Introduction to RMON

RMON is the most important expansion of the standard SNMP. RMON is a set of MIB definitions, used to define standard network monitor functions and interfaces, enabling the communication between SNMP management terminals and remote monitors. RMON provides a highly efficient method to monitor actions inside the subnets.

MID of RMON consists of 10 groups. The switch supports the most frequently used group 1, 2, 3 and 9:

Statistics: Maintain basic usage and error statistics for each subnet monitored by the Agent.

History: Record periodical statistic samples available from Statistics.

Alarm: Allow management console users to set any count or integer for sample intervals and alert thresholds for RMON Agent records.

Event: A list of all events generated by RMON Agent.

Alarm depends on the implementation of Event. Statistics and History display some current or history subnet statistics. Alarm and Event provide a method to monitor any integer data change in the network, and provide some alerts upon abnormal events (sending Trap or record in logs).

1.2.4.4 SNMP Configuration

1.2.4.4.1 SNMP Configuration Task List

1. Enable or disable SNMP Agent server function
2. Configure SNMP community string
3. Configure IP address of SNMP management base
4. Configure engine ID

5. Configure user
6. Configure group
7. Configure view
8. Configuring TRAP
9. Enable/Disable RMON

1. Enable or disable SNMP Agent server function

Command	Explanation
Global Mode	
snmp-server enabled no snmp-server enabled	Enable the SNMP Agent function on the switch; the no command disables the SNMP Agent function on the switch.

2. Configure SNMP community string

Command	Explanation
Global Mode	
snmp-server community {ro rw} {0 7} <string> [access {<num-std> <name>}] [ipv6-access {<ipv6-num-std> <ipv6-name>}] [read <read-view-name>] [write <write-view-name>] no snmp-server community <string> [access {<num-std> <name>}] [ipv6-access {<ipv6-num-std> <ipv6-name>}]	Configure the community string for the switch; the no command deletes the configured community string.

3. Configure IP address of SNMP management station

Command	Explanation
Global Mode	
snmp-server securityip { <ipv4-address> <ipv6-address> } no snmp-server securityip { <ipv4-address> <ipv6-address> }	Configure IPv4/IPv6 security address which is allowed to access the switch on the NMS; the no command deletes the configured security address.
snmp-server securityip enable snmp-server securityip disable	Enable or disable secure IP address check function on the NMS.

4. Configure engine ID

Command	Explanation
Global Mode	
snmp-server engineid <engine-string> no snmp-server engineid	Configure the local engine ID on the switch. This command is used for SNMP v3.

5. Configure user

Command	Explanation

Global Mode	
<pre>snmp-server user <use-string> <group-string> [{authPriv authNoPriv} auth {md5 sha} <word>] [access {<num-std> <name>}] [ipv6-access {<ipv6-num-std> <ipv6-name>}] no snmp-server user <user-string> [access {<num-std> <name>}] [ipv6-access {<ipv6-num-std> <ipv6-name>}]</pre>	Add a user to a SNMP group. This command is used to configure USM for SNMP v3.

6. Configure group

Command	Explanation
Global Mode	
<pre>snmp-server group <group-string> {noauthnopriv authnopriv authpriv} [[read <read-string>] [write <write-string>] [notify <notify-string>]] [access {<num-std> <name>}] [ipv6-access {<ipv6-num-std> <ipv6-name>}] no snmp-server group <group-string> {noauthnopriv authnopriv authpriv} [access {<num-std> <name>}] [ipv6-access {<ipv6-num-std> <ipv6-name>}]</pre>	Set the group information on the switch. This command is used to configure VACM for SNMP v3.

7. Configure view

Command	Explanation
Global Mode	
<pre>snmp-server view <view-string> <oid-string> {include exclude} no snmp-server view <view-string> [<oid-string>]</pre>	Configure view on the switch. This command is used for SNMP v3.

8. Configuring TRAP

Command	Explanation
Global Mode	
<pre>snmp-server enable traps no snmp-server enable traps</pre>	Enable the switch to send Trap message. This command is used for SNMP v1/v2/v3.
<pre>snmp-server host { <host-ipv4-address> <host-ipv6-address> } {v1 v2c {v3 {noauthnopriv authnopriv authpriv}}} <user-string> no snmp-server host { <host-ipv4-address> <host-ipv6-address> } {v1 v2c {v3 {noauthnopriv authnopriv authpriv}}}</pre>	Set the host IPv4/IPv6 address which is used to receive SNMP Trap information. For SNMP v1/v2, this command also configures Trap community string; for SNMP v3, this command also configures Trap user name and security level. The “no” form of this command cancels this IPv4 or IPv6 address.

<code><user-string></code>	
<code>snmp-server trap-source {<ipv4-address> <ipv6-address>}</code> <code>no snmp-server trap-source {<ipv4-address> <ipv6-address>}</code>	Set the source IPv4 or IPv6 address which is used to send trap packet, the no command deletes the configuration.
Port mode	
<code>[no] switchport updown notification enable</code>	Enable/disable the function of sending the trap message to the port of UP/DOWN event.

9. Enable/Disable RMON

Command	Explanation
Global mode	
<code>rmon enable</code> <code>no rmon enable</code>	Enable/disable RMON.

1.2.4.5 Typical SNMP Configuration Examples

The IP address of the NMS is 1.1.1.5; the IP address of the switch (Agent) is 1.1.1.9.

Scenario 1: The NMS network administrative software uses SNMP protocol to obtain data from the switch.

The configuration on the switch is listed below:

```
Switch(config)#snmp-server enable
Switch(config)#snmp-server community rw private
Switch(config)#snmp-server community ro public
Switch(config)#snmp-server securityip 1.1.1.5
```

The NMS can use private as the community string to access the switch with read-write permission, or use public as the community string to access the switch with read-only permission.

Scenario 2: NMS will receive Trap messages from the switch (Note: NMS may have community string verification for the Trap messages. In this scenario, the NMS uses a Trap verification community string of usertrap).

The configuration on the switch is listed below:

```
Switch(config)#snmp-server enable
Switch(config)#snmp-server host 1.1.1.5 v1 usertrap
Switch(config)#snmp-server enable traps
```

Scenario 3: NMS uses SNMP v3 to obtain information from the switch.

The configuration on the switch is listed below:

```
Switch(config)#snmp-server
Switch(config)#snmp-server user tester UserGroup authPriv auth md5 hellotst
Switch(config)#snmp-server group UserGroup AuthPriv read max write max notify max
Switch(config)#snmp-server view max 1 include
```

Scenario 4: NMS wants to receive the v3Trap messages sent by the switch.

The configuration on the switch is listed below:

```
Switch(config)#snmp-server enable
Switch(config)#snmp-server host 10.1.1.2 v3 authpriv tester
Switch(config)#snmp-server enable traps
```

Scenario 5: The IPv6 address of the NMS is 2004:1:2:3::2; the IPv6 address of the switch (Agent) is 2004:1:2:3::1. The NMS network administrative software uses SNMP protocol to obtain data from the switch.

The configuration on the switch is listed below:

```
Switch(config)#snmp-server enable
Switch(config)#snmp-server community rw private
Switch(config)#snmp-server community ro public
Switch(config)#snmp-server securityip 2004:1:2:3::2
```

The NMS can use private as the community string to access the switch with read-write permission, or use public as the community string to access the switch with read-only permission.

Scenario 6: NMS will receive Trap messages from the switch (Note: NMS may have community string verification for the Trap messages. In this scenario, the NMS uses a Trap verification community string of usertrap).

The configuration on the switch is listed below:

```
Switch(config)#snmp-server host 2004:1:2:3::2 v1 usertrap
Switch(config)#snmp-server enable traps
```

1.2.4.6 SNMP Troubleshooting

When users configure the SNMP, the SNMP server may fail to run properly due to physical connection failure and wrong configuration, etc. Users can troubleshoot the problems by following the guide below:

- 👉 Good condition of the physical connection.
- 👉 Interface and datalink layer protocol is Up (use the “show interface” command), and the connection between the switch and host can be verified by ping (use “ping” command).
- 👉 The switch enabled SNMP Agent server function (use “snmp-server” command)
- 👉 Secure IP for NMS (use “snmp-server securityip” command) and community string (use “snmp-server community” command) are correctly configured, as any of them fails, SNMP will not be able to communicate with NMS properly.
- 👉 If Trap function is required, remember to enable Trap (use “snmp-server enable traps” command). And remember to properly configure the target host IP address and community string for Trap (use “snmp-server host” command) to ensure Trap message can be sent to the specified host.
- 👉 If RMON function is required, RMON must be enabled first (use “rmon enable” command).
- 👉 Use “show snmp” command to verify sent and received SNMP messages; Use “show snmp

status” command to verify SNMP configuration information; Use “debug snmp packet” to enable SNMP debugging function and verify debug information.
If users still can’t solve the SNMP problems, Please contact our technical and service center.

1.2.5 Switch Upgrade

Switch provides two ways for switch upgrade: BootROM upgrade and the TFTP/FTP upgrade under Shell.

1.2.5.1 Switch System Files

The system files includes system image file and boot file. The updating of the switch is to update the two files by overwrite the old files with the new ones.

The system image files refers to the compressed files of the switch hardware drivers, and software support program, etc, namely what we usually call the IMG update file. The IMG file can only be saved in the FLASH with a defined name of nos.img

The boot file is for initiating the switch, namely what we usually call the ROM update file (It can be compressed into IMG file if it is of large size). In switch, the boot file is allowed to save in ROM only. Switch mandates the name of the boot file to be boot.rom.

The update method of the system image file and the boot file is the same. The switch supplies the user with two modes of updating: 1. BootROM mode; 2. TFTP and FTP update at Shell mode. This two update method will be explained in details in following two sections.

1.2.5.2 BootROM Upgrade

There is one method for BootROM upgrade: TFTP which can be configured at BootROM command.

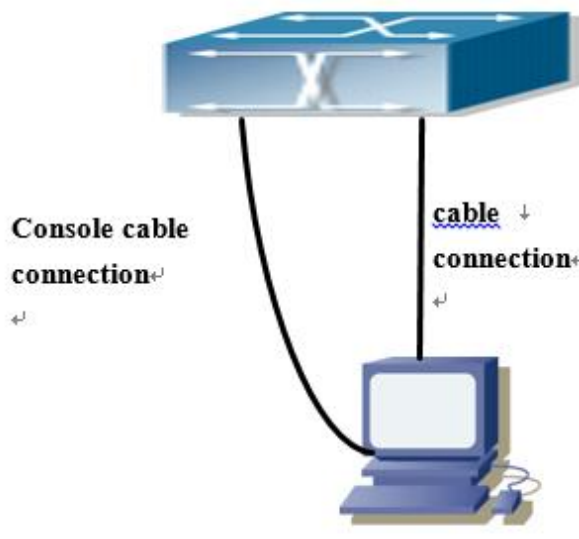

Figure 1-13 Typical topology for switch upgrade in BootROM mode

The **upgrade procedures** are listed below:

Step 1:

As shown in the figure, a PC is used as the console for the switch. A console cable is used to connect PC to the management port on the switch. The PC should have TFTP server software installed and has the boot file required for the upgrade.

Step 2:

Press 'ctrl+b' on switch boot up until the switch enters BootROM monitor mode. The operation result is shown below:

[Boot]:

Step 3:

Under BootROM mode, run 'setconfig' to set the IP address and mask of the switch under BootROM mode, server IP address and mask. Suppose the switch address is 192.168.1.2, and PC address is 192.168.1.66, and select TFTP upgrade, the configuration should like:

[Boot]: setconfig

Host IP Address: [10.1.1.1] 192.168.1.2

Server IP Address: [10.1.1.2] 192.168.1.66

[Boot]:

Step 4:

Enable TFTP server in the PC. run TFTP server program. Before start downloading upgrade file to the switch, verify the connectivity between the server and the switch by ping from the switch. If ping succeeds, run 'load' command in the BootROM mode from the switch; if it fails, perform troubleshooting to find out the cause.

The following update file boot.rom.

[Boot]: load boot.rom

TFTP from server 192.168.1.66; our IP address is 192.168.1.2

Filename 'boot.rom'.

Load address: 0x300000

Loading: #####

#####

done

Bytes transferred = 496240 (79270 hex)

[Boot]:

Step 5:

Execute **write boot.rom** in BootROM mode. The following saves the update file.

[Boot]: write boot.rom

File exists, overwrite? (Y/N)[N] y

Writing flash:/boot.rom.....

Write flash:/boot.rom OK.

[Boot]:

Step 6:

After successful upgrade, execute run or reboot command in BootROM mode to return to CLI configuration interface.

[Boot]: run (or reboot)

Other commands in BootROM mode

1. DIR command

Used to list existing files in the FLASH.

[Boot]: dir

```
5399893  nos.img
```

1 file(s), 0 dir(s)

Total size:6995456 bytes , used size:5422080 bytes, free size:1573376 bytes

[Boot]:

1.2.5.3 FTP/TFTP Upgrade

1.2.5.3.1 Introduction to FTP/TFTP

FTP(File Transfer Protocol)/TFTP(Trivial File Transfer Protocol) are both file transfer protocols that belonging to fourth layer(application layer) of the TCP/IP protocol stack, used for transferring files between hosts, hosts and switches. Both of them transfer files in a client-server model. Their differences are listed below.

FTP builds upon TCP to provide reliable connection-oriented data stream transfer service. However, it does not provide file access authorization and uses simple authentication mechanism (transfers username and password in plain text for authentication). When using FTP to transfer files, two connections need to be established between the client and the server: a management connection and a data connection. A transfer request should be sent by the FTP client to establish management connection on port 21 in the server, and negotiate a data connection through the management connection.

There are two types of data connections: active connection and passive connection.

In active connection, the client transmits its address and port number for data transmission to the server, the management connection maintains until data transfer is complete. Then, using the address and port number provided by the client, the server establishes data connection on port 20 (if not engaged) to transfer data; if port 20 is engaged, the server automatically generates some other port number to establish data connection.

In passive connection, the client, through management connection, notify the server to establish a passive connection. The server then creates its own data listening port and informs the client about the port, and the client establishes data connection to the specified port.

As data connection is established through the specified address and port, there is a third party to provide data connection service.

TFTP builds upon UDP, providing unreliable data stream transfer service with no user authentication or permission-based file access authorization. It ensures correct data transmission by sending and acknowledging mechanism and retransmission of time-out packets. The advantage of TFTP over FTP is that it is a simple and low overhead file transfer service.

Switch can operate as either FTP/TFTP client or server. When switch operates as a FTP/TFTP client, configuration files or system files can be downloaded from the remote FTP/TFTP servers (can be hosts or other switches) without affecting its normal operation. And file list can also be retrieved from the server in ftp client mode. Of course, switch can also upload current configuration files or system files to the remote FTP/TFTP servers (can be hosts or other switches). When switch operates as a FTP/TFTP server, it can provide file upload and download service for authorized FTP/TFTP clients, as file list service as FTP server.

Here are some terms frequently used in FTP/TFTP.

ROM: Short for EPROM, erasable read-only memory. EPROM is replaced by FLASH memory in switch.

SDRAM: RAM memory in the switch, used for system software operation and configuration sequence storage.

FLASH: Flash memory used to save system file and configuration file.

System file: including system image file and boot file.

System image file: refers to the compressed file for switch hardware driver and software support program, usually refer to as IMAGE upgrade file. In switch, the system image file is allowed to save in FLASH only. Switch mandates the name of system image file to be uploaded via FTP in Global Mode to be nos.img, other IMAGE system files will be rejected. **Boot file:** refers to the file initializes the switch, also referred to as the ROM upgrade file (Large size file can be compressed as IMAGE file). In switch, the boot file is allowed to save in ROM only. Switch mandates the name of the boot file to be boot.rom.

Configuration file: including start up configuration file and running configuration file. The distinction between start up configuration file and running configuration file can facilitate the backup and update of the configurations.

Start up configuration file: refers to the configuration sequence used in switch startup. Startup configuration file stores in nonvolatile storage, corresponding to the so-called configuration save. If the device does not support CF, the configuration file stores in FLASH only, if the device supports CF, the configuration file stores in FLASH or CF, if the device supports multi-config file, names the configuration file to be .cfg file, the default is startup.cfg. If the device does not support multi-config file, mandates the name of startup configuration file to be startup-config.

Running configuration file: refers to the running configuration sequence use in the switch. In switch, the running configuration file stores in the RAM. In the current version, the running configuration sequence running-config can be saved from the RAM to FLASH by **write** command or **copy running-config startup-config** command, so that the running configuration sequence becomes the start up configuration file, which is called configuration save. To prevent illicit file

upload and easier configuration, switch mandates the name of running configuration file to be running-config.

Factory configuration file: The configuration file shipped with switch in the name of factory-config. Run **set default** and **write**, and restart the switch, factory configuration file will be loaded to overwrite current start up configuration file.

1.2.5.3.2 FTP/TFTP Configuration

The configurations of switch as FTP and TFTP clients are almost the same, so the configuration procedures for FTP and TFTP are described together in this manual.

1.2.5.3.2.1 FTP/TFTP Configuration Task List

1. FTP/TFTP client configuration

- (1) Upload/download the configuration file or system file.
- (2) For FTP client, server file list can be checked.

2. FTP server configuration

- (1) Start FTP server
- (2) Configure FTP login username and password
- (3) Modify FTP server connection idle time
- (4) Shut down FTP server

3. TFTP server configuration

- (1) Start TFTP server
- (2) Configure TFTP server connection idle time
- (3) Configure retransmission times before timeout for packets without acknowledgement
- (4) Shut down TFTP server

1. FTP/TFTP client configuration

(1) FTP/TFTP client upload/download file

Command	Explanation
Admin Mode	
copy <source-url> <destination-url> [ascii binary]	FTP/TFTP client upload/download file.

(2) For FTP client, server file list can be checked.

Command	Explanation
Admin Mode	
ftp-dir <ftpServerUrl>	For FTP client, server file list can be checked. FtpServerUrl format looks like: ftp: //user: password@IPv4 IPv6 Address.

2. FTP server configuration

(1) Start FTP server

Command	Explanation

Global Mode	
ftp-server enable no ftp-server enable	Start FTP server, the no command shuts down FTP server and prevents FTP user from logging in.

(2) Configure FTP login username and password

Command	Explanation
Global Mode	
ip ftp username <username> password [0 7] <password> no ip ftp username<username>	Configure FTP login username and password; this no command will delete the username and password.

(3) Modify FTP server connection idle time

Command	Explanation
Global Mode	
ftp-server timeout <seconds>	Set connection idle time.

3. TFTP server configuration

(1) Start TFTP server

Command	Explanation
Global Mode	
tftp-server enable no tftp-server enable	Start TFTP server, the no command shuts down TFTP server and prevents TFTP user from logging in.

(2) Modify TFTP server connection idle time

Command	Explanation
Global Mode	
tftp-server retransmission-timeout <seconds>	Set maximum retransmission time within timeout interval.

(3) Modify TFTP server connection retransmission time

Command	Explanation
Global Mode	
tftp-server retransmission-number <number>	Set the retransmission time for TFTP server.

1.2.5.3.3 FTP/TFTP Configuration Examples

The configuration is same for IPv4 address or IPv6 address. The example only for IPv4 address.

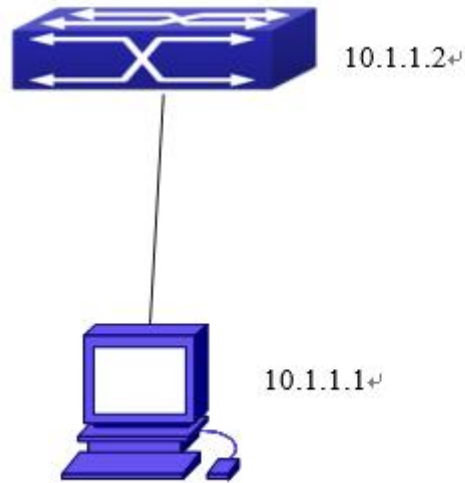

Figure 1- 15 Download nos.img file as FTP/TFTP client

Scenario 1: The switch is used as FTP/TFTP client. The switch connects from one of its ports to a computer, which is a FTP/TFTP server with an IP address of 10.1.1.1; the switch acts as a FTP/TFTP client, the IP address of the switch management VLAN is 10.1.1.2. Download “nos.img” file in the computer to the switch.

👉 FTP Configuration

Computer side configuration:

Start the FTP server software on the computer and set the username “Switch”, and the password “superuser”. Place the “12_30_nos.img” file to the appropriate FTP server directory on the computer.

The configuration procedures of the switch are listed below:

```
Switch(config)#interface vlan 1
Switch(Config-if-Vlan1)#ip address 10.1.1.2 255.255.255.0
Switch(Config-if-Vlan1)#no shut
Switch(Config-if-Vlan1)#exit
Switch(config)#exit
Switch#copy ftp: //Switch:switch@10.1.1.1/12_30_nos.img nos.img
```

With the above commands, the switch will have the “nos.img” file in the computer downloaded to the FLASH.

👉 TFTP Configuration

Computer side configuration:

Start TFTP server software on the computer and place the “12_30_nos.img” file to the appropriate TFTP server directory on the computer.

The configuration procedures of the switch are listed below:

```
Switch(config)#interface vlan 1
Switch(Config-if-Vlan1)#ip address 10.1.1.2 255.255.255.0
Switch(Config-if-Vlan1)#no shut
```

```
Switch(Config-if-Vlan1)#exit
Switch(config)#exit
Switch#copy tftp://10.1.1.1/12_30_nos.img nos.img
```

Scenario 2: The switch is used as FTP server. The switch operates as the FTP server and connects from one of its ports to a computer, which is a FTP client. Transfer the “nos.img” file in the switch to the computer and save as 12_25_nos.img.

The configuration procedures of the switch are listed below:

```
Switch(config)#interface vlan 1
Switch(Config-if-Vlan1)#ip address 10.1.1.2 255.255.255.0
Switch(Config-if-Vlan1)#no shut
Switch(Config-if-Vlan1)#exit
Switch(config)#ftp-server enable
Switch(config)# username Admin password 0 superuser
```

Computer side configuration:

Login to the switch with any FTP client software, with the username “Switch” and password “superuser”, use the command “get nos.img 12_25_nos.img” to download “nos.img” file from the switch to the computer.

Scenario 3: The switch is used as TFTP server. The switch operates as the TFTP server and connects from one of its ports to a computer, which is a TFTP client. Transfer the “nos.img” file in the switch to the computer.

The configuration procedures of the switch are listed below:

```
Switch(config)#interface vlan 1
Switch(Config-if-Vlan1)#ip address 10.1.1.2 255.255.255.0
Switch(Config-if-Vlan1)#no shut
Switch(Config-if-Vlan1)#exit
Switch(config)#tftp-server enable
```

Computer side configuration:

Login to the switch with any TFTP client software, use the “tftp” command to download “nos.img” file from the switch to the computer.

Scenario 4: Switch acts as FTP client to view file list on the FTP server. Synchronization conditions: The switch connects to a computer by an Ethernet port, the computer is a FTP server with an IP address of 10.1.1.1; the switch acts as a FTP client, and the IP address of the switch management VLAN1 interface is 10.1.1.2.

FTP Configuration:

PC side:

Start the FTP server software on the PC and set the username “Switch”, and the password “superuser”.

Switch:

```
Switch(config)#interface vlan 1
```

```
Switch(Config-if-Vlan1)#ip address 10.1.1.2 255.255.255.0
Switch(Config-if-Vlan1)#no shut
Switch(Config-if-Vlan1)#exit
Switch#copy ftp: //Switch: superuser@10.1.1.1
220 Serv-U FTP-Server v2.5 build 6 for WinSock ready...
331 User name okay, need password.
230 User logged in, proceed.
200 PORT Command successful.
150 Opening ASCII mode data connection for /bin/ls.
recv total = 480
nos.img
nos.rom
parsecommandline.cpp
position.doc
qmdict.zip
...(some display omitted here)
show.txt
snmp.TXT
226 Transfer complete.
```

1.2.5.3.4 FTP/TFTP Troubleshooting

1.2.5.3.4.1 FTP Troubleshooting

When upload/download system file with FTP protocol, the connectivity of the link must be ensured, i.e., use the “Ping” command to verify the connectivity between the FTP client and server before running the FTP program. If ping fails, you will need to check for appropriate troubleshooting information to recover the link connectivity.

☞ The following is what the message displays when files are successfully transferred.

Otherwise, please verify link connectivity and retry “copy” command again.

```
220 Serv-U FTP-Server v2.5 build 6 for WinSock ready...
331 User name okay, need password.
230 User logged in, proceed.
200 PORT Command successful.
nos.img file length = 1526021
read file ok
send file
150 Opening ASCII mode data connection for nos.img.
226 Transfer complete.
close ftp client.
```

☞ The following is the message displays when files are successfully received. Otherwise, please verify link connectivity and retry “copy” command again.

```
220 Serv-U FTP-Server v2.5 build 6 for WinSock ready...
331 User name okay, need password.
230 User logged in, proceed.
200 PORT Command successful.
recv total = 1526037
*****
write ok
150 Opening ASCII mode data connection for nos.img (1526037 bytes).
226 Transfer complete.
```

If the switch is upgrading system file or system start up file through FTP, the switch must not be restarted until “close ftp client” or “226 Transfer complete.” is displayed, indicating upgrade is successful, otherwise the switch may be rendered unable to start. If the system file and system start up file upgrade through FTP fails, please try to upgrade again or use the BootROM mode to upgrade.

1.2.5.3.4.2 TFTP Troubleshooting

When upload/download system file with TFTP protocol, the connectivity of the link must be ensured, i.e., use the “**Ping**” command to verify the connectivity between the TFTP client and server before running the TFTP program. If ping fails, you will need to check for appropriate troubleshooting information to recover the link connectivity.

- ☞ The following is the message displays when files are successfully transferred. Otherwise, please verify link connectivity and retry “copy” command again.

```
nos.img file length = 1526021
read file ok
begin to send file, wait...
file transfers complete.
Close tftp client.
```

- ☞ The following is the message displays when files are successfully received. Otherwise, please verify link connectivity and retry “copy” command again.

```
begin to receive file, wait...
recv 1526037
*****
write ok
transfer complete
close tftp client.
```

If the switch is upgrading system file or system start up file through TFTP, the switch must not be restarted until “close tftp client” is displayed, indicating upgrade is successful, otherwise the switch may be rendered unable to start. If the system file and system start up file upgrade through TFTP fails, please try upgrade again or use the BootROM mode to upgrade.

1.3 File System

1.3.1 Introduction to File Storage Devices

File storage devices used in switches mainly include FLASH cards. As the most common storage device, FLASH is usually used to store system image files (IMG files), system boot files (ROM files) and system configuration files (CFG files).

Flash can copy, delete, or rename files under Shell or Bootrom mode.

1.3.2 File System Operation Configuration Task list

1. The formatting operation of storage devices
2. The creation of sub-directories
3. The deletion of sub-directory
4. Changing the current working directory of the storage device
5. The display operation of the current working directory
6. The display operation of information about a designated file or directory
7. The deletion of a designated file in the file system
8. The renaming operation of files
9. The copying operation of files

1. The formatting operation of storage devices

Command	Explanation
Admin Configuration Mode	
format <device>	Format the storage device.

2. The creation of sub-directories

Command	Explanation
Admin Configuration Mode	
mkdir <directory>	Create a sub-directory in a designated directory on a certain device.

3. The deletion of sub-directory

Command	Explanation
Admin Configuration Mode	
rmdir <directory>	Delete a sub-directory in a designated directory on a certain device.

4. Changing the current working directory of the storage device

Command	Explanation

Admin Configuration Mode	
cd <directory>	Change the current working directory of the storage device.

5. The display operation of the current working directory

Command	Explanation
Admin Configuration Mode	
pwd	Display the current working directory.

6. The display operation of information about a designated file or directory

Command	Explanation
Admin Configuration Mode	
dir [WORD]	Display information about a designated file or directory on the storage device.

7. The deletion of a designated file in the file system

Command	Explanation
Admin Configuration Mode	
delete <file-url>	Delete the designated file in the file system.

8. The renaming operation of files

Command	Explanation
Admin Configuration Mode	
rename <source-file-url> <dest-file>	Change the name of a designated file on the switch to a new one.

9. The copy operation of files

Command	Explanation
Admin Configuration Mode	
copy <source-file-url> <dest-file-url>	Copy a designated file on the switch and store it as a new one.

1.3.3 Typical Applications

Copy an IMG file flash:/nos.img stored in the FLASH on the boardcard, to cf:/nos-6.1.11.0.img.

The configuration of the switch is as follows:

```
Switch#copy flash:/nos.img flash:/nos-6.1.11.0.img
```

```
Copy flash:/nos.img to flash:/nos-6.1.11.0.img? [Y:N] y
```

```
    Copied file flash:/nos.img to flash:/nos-6.1.11.0.img.
```

Copy an IMG file nandflash:/nos.img stored in the NANDFLASH on the boardcard, to

```
flash:/nos.img.
```

The configuration of the switch is as follows:

```
Switch#copy nandflash:/nos.img flash:/nos.img
```

```
Confirm to overwrite the existed destination file? [Y/N]:y
```

```
Begin to write local file, please wait...
```

```
Write ok.
```

1.3.4 Troubleshooting

If errors occur when users try to implement file system operations, please check whether they are caused by the following reasons

- ☞ Whether file names or paths are entered correctly.
- ☞ When renaming a file, whether it is in use or the new file name is already used by an existing file or directory.

1.4 Cluster

1.4.1 Introduction to cluster network management

Cluster network management is an in-band configuration management. Unlike CLI, SNMP and Web Config which implement a direct management of the target switches through a management workstation, cluster network management implements a direct management of the target switches (member switches) through an intermediate switch (commander switch). A commander switch can manage multiple member switches. As soon as a Public IP address is configured in the commander switch, all the member switches which are configured with private IP addresses can be managed remotely. This feature economizes public IP addresses which are short of supply. Cluster network management can dynamically discover cluster feature enabled switches (candidate switches). Network administrators can statically or dynamically add the candidate switches to the cluster which is already established. Accordingly, they can configure and manage the member switches through the commander switch. When the member switches are distributed in various physical locations (such as on the different floors of the same building), cluster network management has obvious advantages. Moreover, cluster network management is an in-band management. The commander switch can communicate with member switches in existing network. There is no need to build a specific network for network management.

Cluster network management has the following features:

- ☞ Save IP addresses
- ☞ Simplify configuration tasks
- ☞ Indifference to network topology and distance limitation

- ✎ Auto detecting and auto establishing
- ✎ With factory default settings, multiple switches can be managed through cluster network management
- ✎ The commander switch can upgrade and configure any member switches in the cluster

1.4.2 Cluster Network Management Configuration

Sequence

Cluster Network Management Configuration Sequence:

1. Enable or disable cluster function
2. Create cluster
 - 1) Configure private IP address pool for member switches of the cluster
 - 2) Create or delete cluster
 - 3) Add or remove a member switch
3. Configure attributes of the cluster in the commander switch
 - 1) Enable or disable automatically adding cluster members
 - 2) Set automatically added members to manually added ones
 - 3) Set or modify the time interval of keep-alive messages on switches in the cluster.
 - 4) Set or modify the max number of lost keep-alive messages that can be tolerated
 - 5) Clear the list of candidate switches maintained by the switch
4. Configure attributes of the cluster in the candidate switch
 - 1) Set the time interval of keep-alive messages of the cluster
 - 2) Set the max number of lost keep-alive messages that can be tolerated in the cluster
5. Remote cluster network management
 - 1) Remote configuration management
 - 2) Remotely upgrade member switch
 - 3) Reboot member switch
6. Manage cluster network with web
 - 1) Enable http
7. Manage cluster network with snmp
 - 1) Enable snmp server

1. Enable or disable cluster

Command	Explanation
Global Mode	
cluster run [key <WORD>] [vid <VID>] no cluster run	Enable or disable cluster function in the switch.

2. Create a cluster

Command	Explanation
Global Mode	
cluster ip-pool <commander-ip> no cluster ip-pool	Configure the private IP address pool for cluster member devices.
cluster commander [<cluster_name>] no cluster commander	Create or delete a cluster.
cluster member {candidate-sn <candidate-sn> mac-address <mac-addr> [id <member-id>]} no cluster member {id <member-id> mac-address <mac-addr>}	Add or remove a member switch.

3. Configure attributes of the cluster in the commander switch

Command	Explanation
Global Mode	
cluster auto-add no cluster auto-add	Enable or disable adding newly discovered candidate switch to the cluster.
cluster member auto-to-user	Change automatically added members into manually added ones.
cluster keepalive interval <second> no cluster keepalive interval	Set the keep-alive interval of the cluster.
cluster keepalive loss-count <int> no cluster keepalive loss-count	Set the max number of lost keep-alive messages that can be tolerated in the cluster.
Admin mode	
clear cluster nodes [nodes-sn <candidate-sn-list> mac-address <mac-addr>]	Clear nodes in the list of candidate switches maintained by the switch.

4. Configure attributes of the cluster in the candidate switch

Command	Explanation
Global Mode	
cluster keepalive interval <second> no cluster keepalive interval	Set the keep-alive interval of the cluster.
cluster keepalive loss-count <int> no cluster keepalive loss-count	Set the max number of lost keep-alive messages that can be tolerated in the clusters.

5. Remote cluster network management

Command	Explanation

Admin Mode	
rcommand member <member-id>	In the commander switch, this command is used to configure and manage member switches.
rcommand commander	In the member switch, this command is used to configure the commander switch.
cluster reset member [id <member-id> mac-address <mac-addr>]	In the commander switch, this command is used to reset the member switch.
cluster update member <member-id> <src-url> <dst-filename>[ascii binary]	In the commander switch, this command is used to remotely upgrade the member switch. It can only upgrade nos.img file.

6. Manage cluster network with web

Command	Explanation
Global Mode	
ip http server	Enable http function in commander switch and member switch. Notice: must insure the http function be enabled in member switch when commander switch visiting member switch by web. The commander switch visit member switch via beat member node in member cluster topology.

7. Manage cluster network with snmp

Command	Explanation
Global Mode	
snmp-server enable	Enable snmp server function in commander switch and member switch. Notice: must insure the snmp server function be enabled in member switch when commander switch visiting member switch by snmp. The commander switch visit member switch via configure character string <commander-community>@sw<member id>.

1.4.3 Examples of Cluster Administration

Scenario:

The four switches SW1-SW4, amongst the SW1 is the command switch and other switches are member switch. The SW2 and SW4 is directly connected with the command switch, SW3 connects to the command switch through SW2.

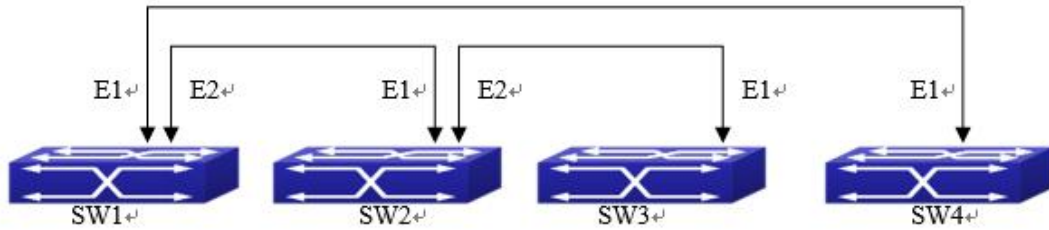

Fig 4-1 Examples of Cluster

Configuration Procedure

1. Configure the command switch

Configuration of SW1:

```
Switch(config)#cluster run
```

```
Switch(config)#cluster ip-pool 10.2.3.4
```

```
Switch(config)#cluster commander 5526
```

```
Switch(config)#cluster auto-add
```

2. Configure the member switch

Configuration of SW2-SW4

```
Switch(config)#cluster run
```

1.4.4 Cluster Administration Troubleshooting

When encountering problems in applying the cluster admin, please check the following possible causes:

- ☞ If the command switch is correctly configured and the auto adding function (cluster auto-add) is enabled. If the ports connected the command switch and member switch belongs to the cluster vlan.
- ☞ After cluster commander is enabled in VLAN1 of the command switch, please don't enable a routing protocol (RIP, OSPF, BGP) in this VLAN in order to prevent the routing protocol from broadcasting the private cluster addresses in this VLAN to other switches and cause routing loops.
- ☞ Whether the connection between the command switch and the member switch is correct. We can use the debug cluster packets to check if the command and the member switches can receive and process related cluster admin packets correctly.

1.5 USB

1.5.1 Introduction

When there is USB device inserted or pulled out, the switch can detect that information of USB hot inserting and pulling out and the switch will mount or uninstall the USB device.

When there is USB device inserted, the switch will mount the USB file system. It can read, copy, delete, rename the files in USB, and it can also recover the configuration, download the files and save the files.

This device supports the flow-passed warning function of the USB. When the actual electric current exceeds the rated current of the device, the switch will prompt user that the temperature is too high. And then, there is the danger of burning out the device if the USB is inserted.

1.5.2 USB Function Configuration List

1. Mount the USB device and enter in the USB letter
2. Show the USB letter information
3. Copy the source file to be the destination file
4. Delete the file content
5. Rename the file name
6. Update the config file under the USB letter to the switch
7. Update the bootrom file under the USB letter to the switch
8. Update the img file under the USB letter to the switch
9. Create the content
10. Delete the existed content
11. Uninstall the USB device

1. Mount the USB device and enter in the USB letter

Command	Explanation
Admin Mode	
cd usb:	Enter in the USB letter.

2. Show the USB letter information

Command	Explanation
Admin Mode	
dir	Show the USB letter information.

3. Copy the source file to be the destination file

Command	Explanation
Admin Mode	
copy source destination	Copy the source file to be the destination

	file.
--	-------

4. Delete the file content

Command	Explanation
Admin Mode	
delete filename	Delete the file.

5. Rename the file name

Command	Explanation
Admin Mode	
rename source destination	Rename the source file name to be the destination file name.

6. Update the config file under the USB letter to the switch

Command	Explanation
Admin Mode	
copy usb:/startup.cfg startup.cfg	Update the config file under the USB letter to the switch. The reverse transmission is supported: copy startup.cfg usb:/startup.cfg

7. Update the bootrom file under the USB letter to the switch

Command	Explanation
Admin Mode	
copy usb:/boot.rom boot.rom	Update the bootrom file under the USB letter to the switch. The reverse transmission is supported: copy boot.rom usb:/boot.rom

8. Update the img file under the USB letter to the switch

Command	Explanation
Admin Mode	
copy usb:/nos.img nos.img	Update the img file under the USB letter to the switch. The reverse transmission is supported: copy nos.img usb:/nos.img

9. Create the content

Command	Explanation
Admin Mode	
mkdir	Create the content.

10. Delete the existed content

Command	Explanation
Admin Mode	
rmdir	Delete the existed content.

1.5.3 USB Function Examples

Delete source1.txt in the usb letter, and rename tt.txt in the usb letter as tttt.txt.

Create the new content of sw1 in the usb letter.

```
Switch#delete source1.txt
```

```
Switch#rename usb:/tt.txt usb:/tttt.txt
```

```
Switch#mkdir sw1
```

1.5.4 USB Function Troubleshooting

- ☞ Currently, only the USB device mounting and uninstalling under the CLI user operation page mode is supported. This command is not supported under the non-CLI user operation page mode.
- ☞ Make sure the switch is power-on and the USB device is inserted correctly. The file content in the USB device will mount to the file system of the switch automatically.
- ☞ For the reading and writing function of USB, the hot inserting and pulling out are not supported currently.
- ☞ Insert the USB device, the file content will not mount to the switch file system, this function does not support the Chinese recognition and displaying of the file content.
- ☞ Input dir command directly, show the file content under the flash letter as default. If user want it to show the file information of the usb, input **cd usb:** to enter the usb letter, and then input **dir** to show the file information. User can also use the absolute path and input **dir usb:** to show the file content.
- ☞ This command does not support the big file showing currently.

1.6 Device Management

1.6.1 Device Management Brief

The device management function of switch provides information about line card status, line card operation debugging, power supply and fan status. This function enables the maintenance and management of the physical devices and restart of the switch and line cards, and hot swapping of the cards. Switch supports dual-master mode. If 2 master management cards are present in the system, the master control board in the smaller slot number becomes the Active Master and the other board becomes the Standby Master.

1.6.2 Device Management Configuration

1.6.2.1 Monitor and Debug Task

1. Display the chip information
2. Display information of the fan status
3. Display information of the power status

1. Display the chip information

Command	Explanation
Admin Mode	
show [member <member-id>] slot <slot-id>	Show basic information of each chip.

2. Display the information of the fan status

Command	Explanation
Admin Mode	
show fan	Shows whether the fan tray is in place and its running status, and shows the speed of the fan.

3. Display the information of the power status

Command	Explanation
Admin Mode	
show power	Shows if the power supply is in place and its running status.

Chapter 2 Network Security Operations Manual

2.1 Introduction to Network Security Features

Network security refers to the ability to protect networks from attacks, intrusions, interference, damage, and unauthorized use, as well as accidents, by taking necessary measures, so that networks can operate stably and reliably, and ensure the integrity, confidentiality, availability, authenticity, and controllability of network data. It covers all aspects of computer networks, including hardware, software, data, and the overall security of the system. The importance of network security lies in the fact that it has become an important part of national security and is directly related to the stability and development of all fields such as politics, economy, culture, society, ecology, and defense.

The focus of this chapter is mainly to ensure the security of passwords through encryption and the complexity of passwords, and to ensure the integrity and confidentiality of data.

2.2 Network Security Feature Configuration

2.2.1 Modification of Port Number Function

Configuration Task Sequence

1. Modify the default SSH service port on the server side
2. Modify the default TELNET service port on the server side
3. Modify the default SNMP service port on the server side

Command	Explain
Global configuration mode	
[no] ssh-server dst-port <port-number>	Modify (disable) the default port number function of the SSH server.
[no] telnet-server dst-port <port-number>	Modify (disable) the function of the default port number of the TELNET server.
[no] snmp-server dst-port <port-number>	Modify (disable) the function of the default port number of the SNMP server.

2.2.2 Modify the configuration task sequence of the encryption algorithm function

1. Modify the SSL encryption algorithm
2. Modify the SSH encryption algorithm

Command	Explain
Global configuration mode	
[no] ip http secure-ciphersuite { aes128-gcm-sha256 aes128-sha aes128-sha256 aes256-sha aes256-sha256 ecdhe-rsa-aes128-gcm-sha256 ecdhe-rsa-aes128-sha ecdhe-rsa-aes256-sha }	Enable or disable the SSL encryption algorithm. All algorithms are selected by default.
[no] ssh-server encryption-algorithm (add remove) { aes128-cbc 3des-cbc aes128-ctr aes256-ctr aes256-cbc 3des-ctr all }	The SSH encryption algorithm component is added (removed). When the SSH encryption algorithm is deleted, only aes-128-ctr, aes-256-ctr, and 3des-ctr algorithms are available by default.

2.2.3 Password security function configures task sequence

1. Variable default password
2. Change the default password forcibly
3. Cryptographic strength check
4. Password validity period
5. Error message prompt
6. Password echo
7. User forces secure input

Command	Explain
Global configuration mode	
[no] service default user password macbased	Configure the factory default password of the device. The default password is generated by the MD5 calculation based on the VLAN MAC address of the device. The no operation of this command is to restore the factory default password.

[no] first-login change password	(Cancel) The default password is forcibly changed at the first login.
[no] userpassword restriction { min-length <1-32> format-mix (<2-4>) max-consecutive-char <2-32> max-consecutive-identical-char <2-32>}	(Cancel) Configure password strength checks, which include length, type, and combination. The length is 1-32; The value can be uppercase letters, lowercase letters, digits, and special characters, including 2 to 4 types. The combination contains a maximum number of adjacent characters and a maximum number of consecutive identical characters.
[no] service user password valid-time <0-90>	Set the password validity period. no indicates that the password is valid permanently.
[no] user-login failed msg neutral	When a user fails to log in, the prompt message does not contain the specific cause of the authentication failure, such as the incorrect password and the user does not exist. The neutral message is only displayed, and no indicates the specific content.
[no] password feedback (none star)	The default value is asterisk (*).
[no] userpassword security-config	(Cancel) Configure mandatory user password security

2.2.4 Configure the task sequence of the sensitive information encryption function

1. The encryption function was enabled
2. Configuring the encryption Mode

Cmmand	Explain
Global configuration mode	
[no] service password-encryption	Configure (disable) the trial encryption mode
[no] service password-encryption type user algo (md5 sha256 aes (salt)) sm4 (salt))	Configure (delete) the encryption method, encryption algorithm used, and salt value

2.2.5 Configure the task sequence of the important file verification function

1. The IMG and configuration file verification function was enabled

Command	Explain
Global configuration mode	
[no] boot (img startup-config) check enable	Enable or disable img verification or configuration file verification

Examples of network security features

Example1:

Users have the following configuration requirements: Switch configuration startup check configuration file, and login password is required. The validity period is 10 days.

The configuration steps are as follows:

```
Switch(config)#
Switch(config)#authentication line console login local
Switch(config)#boot startup-config check enable
Switch(config)#service user password valid-time 10
```

Example2:

The user must meet the following requirements: 1. The password can only be entered in ciphertext with asterisk (*). The password must contain at least 10 digits, uppercase and lowercase letters, and special characters. 2. The password in the configuration is encrypted using SM4 and cannot be the same every time it is displayed.

The configuration steps are as follows:

```
Switch(config)#
Switch(config)#service password-encryption
Switch(config)#service password-encryption type user algo sm4 salt
Error:user admin is Encrypt by other algo, please delete first
Switch(config)#no username admin
Switch(config)#service password-encryption type user algo sm4 salt
Switch(config)#userpassword security-config
Switch(config)#password feedback star
Switch(config)#userpassword restriction min-length 10 format-mix 4
Switch(config)#username aaa password
Password:*****
Invalid password, password must no lease than 4 type(ex:0-9,A-Z,a-z,special character) mixed
format!
Switch(config)#username aaa password
Password:*****
Switch(config)#show running-config |include aaa
username aaa password 7 Zjs+r7VvTdI4oHwSJXHdOn3pim5RGKcI5ZOPFUXchjU=
Switch(config)#show running-config |include aaa
username aaa password 7 Zjs+r7VvTdI4oHwSJXHdOiwj4bAHlloyEj9vRRNVh+Sc=
```

Example3:

The configuration requirements are as follows: When the user uses ssh to connect to the

device, the 3des-cbc and 3des-ctr algorithms cannot be used.

The configuration steps are as follows:

```
Switch(config)#
```

```
Switch(config)#ssh-server enable
```

ssh is enabled successfully.

```
Switch(config)#ssh-server encryption-algorithm add all
```

```
Switch(config)#ssh-server encryption-algorithm remove 3des-cbc 3des-ctr
```

Chapter 3 Layer 2 services Configuration

3.1 Port Configuration

3.1.1 Introduction to Port

Switch contains Cable ports and Combo ports. The Combo ports can be configured as either 1000GX-TX ports or SFP Gigabit fiber ports.

If the user needs to configure some network ports, he/she can use the interface ethernet <interface-list> command to enter the appropriate Ethernet port configuration mode, where <interface-list> stands for one or more ports. If <interface-list> contains multiple ports, special characters such as ';' or '-' can be used to separate ports, ';' is used for discrete port numbers and '-' is used for consecutive port numbers. Suppose an operation should be performed on ports 2,3,4,5 the command would look like: interface ethernet 1/0/2-5. Port speed, duplex mode and traffic control can be configured under Ethernet Port Mode causing the performance of the corresponding network ports to change accordingly.

3.1.2 Network Port Configuration Task List

1. Enter the network port configuration mode
2. Configure the properties for the network ports
 - (1) Configure combo mode for combo ports
 - (2) Enable/Disable ports
 - (3) Configure port names
 - (4) Configure port cable types
 - (5) Configure port speed and duplex mode
 - (6) Configure bandwidth control
 - (7) Configure traffic control
 - (8) Enable/Disable port loopback function
 - (9) Configure broadcast storm control function for the switch
 - (10) Configure scan port mode
 - (11) Configure rate-violation control of the port
 - (12) Configure interval of port-rate-statistics
 - (13) Configure the port not to receive the packet
3. Virtual cable test

1. Enter the Ethernet port configuration mode

Command	Explanation
Global Mode	
interface ethernet < <i>interface-list</i> >	Enters the network port configuration mode.

2. Configure the properties for the Ethernet ports

Command	Explanation
Port Mode	
media-type {copper copper-preferred-auto fiber sfp-preferred-auto}	Sets the combo port mode (combo ports only).
shutdown no shutdown	Enables/Disables specified ports.
description <string> no description	Names or cancels the name of specified ports.
speed-duplex {auto [10 [100 [1000]] [auto full half]]} force10-half force10-full force100-half force100-full force100-fx [module-type {auto-detected no-phy-integrated phy-integrated}] {{force1g-half force1g-full} [nonegotiate [master slave]]} force10g-full no speed-duplex	Sets port speed and duplex mode of 100/1000Base-TX or 100Base-FX ports. The no format of this command restores the default setting, i.e., negotiates speed and duplex mode automatically.
negotiation {on off}	Enables/Disables the auto-negotiation function of 1000Base-FX ports.
bandwidth control < <i>bandwidth</i> > [both receive transmit] no bandwidth control	Sets or cancels the bandwidth used for incoming/outgoing traffic for specified ports.
flow control no flow control	Enables/Disables traffic control function for specified ports.
loopback no loopback	Enables/Disables loopback test function for specified ports.
storm-control {unicast broadcast multicast} <packets>	Enables the storm control function for broadcasts, multicasts and unicasts with unknown destinations (short for broadcast), and sets the allowed broadcast packet number; the no format of this command disables the broadcast storm control function.
port-scan-mode {interrupt poll} no port-scan-mode	Configure port-scan-mode as interrupt or poll mode, the no command restores the default port-scan-mode.
rate-violation <200-2000000> [recovery	Set the max packet reception rate of a port. If

<no-86400> no rate-violation	the rate of the received packet violates the packet reception rate, shut down this port and configure the recovery time, the default is 300s. The no command will disable the rate-violation function of a port.
switchport discard packet { tag untag } no switchport discard packet { tag untag }	Configure the port not to receive the packet of tag or untag; the no command cancel the restriction of discard, it means the port is allowed to receive the packet of tag or untag.
Global Mode	
port-rate-statistics interval <interval -value>	Configure the interval of port-rate-statistics.

3. Virtual cable test

Command	Explanation
Admin Mode	
virtual-cable-test interface (ethernet)IFNAME	Test virtual cables of the port.

3.1.3 Port Configuration Example

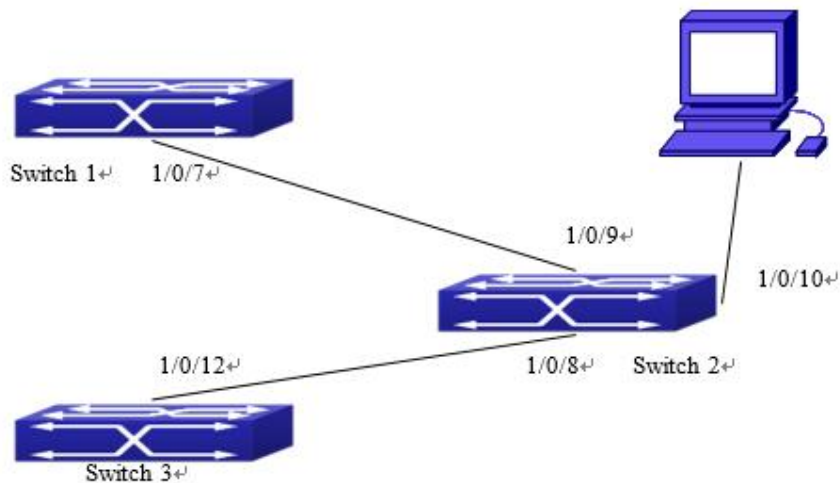

Fig 1- 1 Port Configuration Example

No VLAN has been configured in the switches, default VLAN1 is used.

Switch	Port	Property
Switch1	1/0/7	Ingress bandwidth limit: 50 M
Switch2	1/0/8	Mirror source port
	1/0/9	100Mbps full, mirror source port
	1/0/10	1000Mbps full, mirror destination port

Switch3	1/0/12	100Mbps full
---------	--------	--------------

The configurations are listed below:

Switch1:

```
Switch1(config)#interface ethernet 1/0/7
Switch1(Config-If-Ethernet1/0/7)#bandwidth control 50000 both
```

Switch2:

```
Switch2(config)#interface ethernet 1/0/9
Switch2(Config-If-Ethernet1/0/9)#speed-duplex force100-full
Switch2(Config-If-Ethernet1/0/9)#exit
Switch2(config)#interface ethernet 1/0/10
Switch2(Config-If-Ethernet1/0/10)#speed-duplex force1g-full
Switch2(Config-If-Ethernet1/0/10)#exit
Switch2(config)#monitor session 1 source interface ethernet 1/0/8;1/0/9
Switch2(config)#monitor session 1 destination interface ethernet 1/0/10
```

Switch3:

```
Switch3(config)#interface ethernet 1/0/12
Switch3(Config-If-Ethernet1/0/12)#speed-duplex force100-full
Switch3(Config-If-Ethernet1/0/12)#exit
```

3.1.4 Port Troubleshooting

Here are some situations that frequently occurs in port configuration and the advised solutions:

- ☞ Two connected fiber interfaces won't link up if one interface is set to auto-negotiation but the other to forced speed/duplex. This is determined by IEEE 802.3.
- ☞ The following combinations are not recommended: enabling traffic control as well as setting multicast limiting for the same port; setting broadcast, multicast and unknown destination unicast control as well as port bandwidth limiting for the same port. If such combinations are set, the port throughput may fall below the expected performance.
- ☞ For Combo port, it supports the forced copper mode and the forced fiber mode (default mode), here, copper port will not be up

3.2 Port Isolation

3.2.1 Introduction to Port Isolation Function

Port isolation is an independent port-based function working in an inter-port way, which

isolates flows of different ports from each other. With the help of port isolation, users can isolate ports within a VLAN to save VLAN resources and enhance network security. After this function is configured, the ports in a port isolation group will be isolated from each other, while ports belonging to different isolation groups or no such group can forward data to one another normally. No more than 16 port isolation groups can a switch have.

3.2.2 Task Sequence of Port Isolation

1. Create an isolate port group
2. Add Ethernet ports into the group
3. Specify the flow to be isolated
4. Display the configuration of port isolation

1. Create an isolate port group

Command	Explanation
Global Mode	
isolate-port group <WORD> no isolate-port group <WORD>	Set a port isolation group; the no operation of this command will delete the port isolation group.

2. Add Ethernet ports into the group

Command	Explanation
Global Mode	
isolate-port group <WORD> switchport interface [ethernet port-channel] <IFNAME> no isolate-port group <WORD> switchport interface [ethernet port-channel] <IFNAME>	Add one port or a group of ports into a port isolation group to isolate, which will become isolated from the other ports in the group; the no operation of this command will remove one port or a group of ports out of a port isolation group.

3. Specify the flow to be isolated

Command	Explanation
Global Mode	
isolate-port apply [<12 13 all>]	Apply the port isolation configuration to isolate layer-2 flows, layer-3 flows or all flows.

4. Display the configuration of port isolation

Command	Explanation
Admin Mode and global Mode	
show isolate-port group [<WORD>]	Display the configuration of port isolation, including all configured port isolation groups and Ethernet ports in each group.

3.2.3 Port Isolation Function Typical Examples

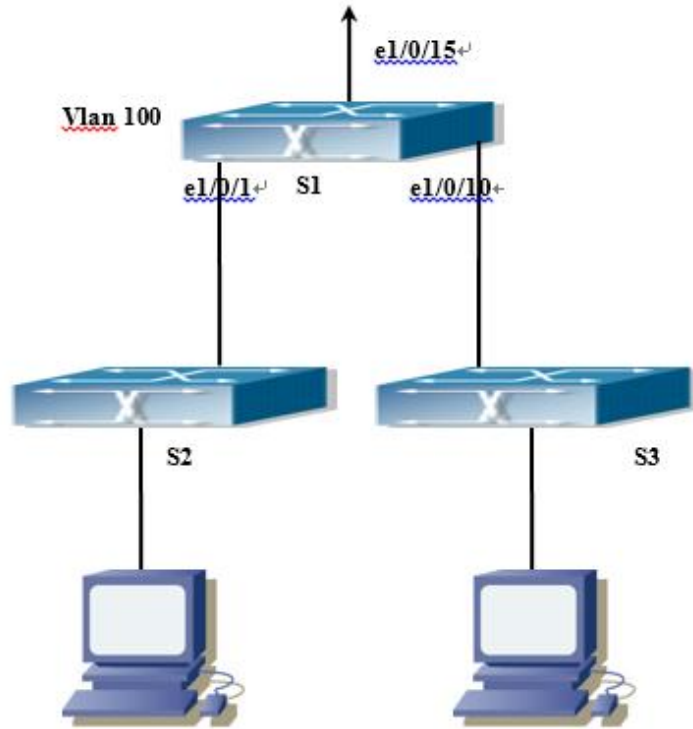

Figure 2- 1 Typical example of port isolation function

The topology and configuration of switches are showed in the figure above, with e1/0/1, e1/0/10 and e1/0/15 all belonging to VLAN 100. The requirement is that, after port isolation is enabled on switch S1, e1/0/1 and e1/0/10 on switch S1 can not communicate with each other, while both of them can communicate with the uplink port e1/0/15. That is, the communication between any pair of downlink ports is disabled while that between any downlink port and a specified uplink port is normal. The uplink port can communicate with any port normally.

The configuration of S1:

```
Switch(config)#isolate-port group test
```

```
Switch(config)#isolate-port group test switchport interface ethernet 1/0/1;1/0/10
```

3.3 Port Loopback Detection

3.3.1 Introduction to Port Loopback Detection

Function

With the development of switches, more and more users begin to access the network through Ethernet switches. In enterprise network, users access the network through layer-2 switches, which means urgent demands for both internet and the internal layer 2 Interworking. When layer 2 Interworking is required, the messages will be forwarded through MAC addressing the accuracy of which is the key to a correct Interworking between users. In layer 2 switching, the messages are forwarded through MAC addressing. Layer 2 devices learn MAC addresses via learning source MAC address, that is, when the port receives a message from an unknown source MAC address, it will add this MAC to the receive port, so that the following messages with a destination of this MAC can be forwarded directly, which also means learn the MAC address once and for all to forward messages.

When a new source MAC is already learnt by the layer 2 device, only with a different source port, the original source port will be modified to the new one, which means to correspond the original MAC address with the new port. As a result, if there is any loopback existing in the link, all MAC addresses within the whole layer 2 network will be corresponded with the port where the loopback appears (usually the MAC address will be frequently shifted from one port to another), causing the layer 2 network collapsed. That is why it is a necessity to check port loopbacks in the network. When a loopback is detected, the detecting device should send alarms to the network management system, ensuring the network manager is able to discover, locate and solve the problem in the network and protect users from a long-lasting disconnected network.

Since detecting loopbacks can make dynamic judgment of the existence of loopbacks in the link and tell whether it has gone, the devices supporting port control (such as port isolation and port MAC address learning control) can maintain that automatically, which will not only reduce the burden of network managers but also response time, minimizing the effect caused loopbacks to the network.

3.3.2 Port Loopback Detection Function Configuration

Task List

1. Configure the time interval of loopback detection
2. Enable the function of port loopback detection
3. Configure the control method of port loopback detection
4. Display and debug the relevant information of port loopback detection
5. Configure the loopback-detection control mode (automatic recovery enabled or not)

1. Configure the time interval of loopback detection

Command	Explanation
Global Mode	
loopback-detection interval-time <i><loopback></i> <i><no-loopback></i> no loopback-detection interval-time	Configure the time interval of loopback detection.

2. Enable the function of port loopback detection

Command	Explanation
Port Mode	
loopback-detection specified-vlan <i><vlan-list></i> no loopback-detection specified-vlan <i><vlan-list></i>	Enable and disable the function of port loopback detection.

3. Configure the control method of port loopback detection

Command	Explanation
Port Mode	
loopback-detection control {shutdown block learning} no loopback-detection control	Enable and disable the function of port loopback detection control.

4. Display and debug the relevant information of port loopback detection

Command	Explanation
Admin Mode	
debug loopback-detection no debug loopback-detection	Enable the debug information of the function module of port loopback detection. The no operation of this command will disable the debug information.
show loopback-detection [interface <i><interface-list></i>]	Display the state and result of the loopback detection of all ports, if no parameter is provided; otherwise, display the state and result of the corresponding ports.

5. Configure the loopback-detection control mode (automatic recovery enabled or not)

Command	Explanation
Global Mode	
loopback-detection control-recovery timeout <0-3600>	Configure the loopback-detection control mode (automatic recovery enabled or not) or recovery time.

3.3.3 Port Loopback Detection Function Example



Figure 2-2 Typical example of port loopback detection

As shown in the above configuration, the switch will detect the existence of loopbacks in the network topology. After enabling the function of loopback detection on the port connecting the switch with the outside network, the switch will notify the connected network about the existence of a loopback, and control the port on the switch to guarantee the normal operation of the whole network.

The configuration task sequence of SWITCH:

```
Switch(config)#loopback-detection interval-time 35 15
Switch(config)#interface ethernet 1/0/1
Switch(Config-If-Ethernet1/0/1)#loopback-detection special-vlan 1-3
Switch(Config-If-Ethernet1/0/1)#loopback-detection control block
```

If adopting the control method of block, MSTP should be globally enabled. And the corresponding relation between the spanning tree instance and the VLAN should be configured.

```
Switch(config)#spanning-tree
Switch(config)#spanning-tree mst configuration
Switch(Config-Mstp-Region)#instance 1 vlan 1
Switch(Config-Mstp-Region)#instance 2 vlan 2
Switch(Config-Mstp-Region)#
```

3.3.4 Port Loopback Detection Troubleshooting

The function of port loopback detection is disabled by default and should only be enabled if required.

3.4 ULDP

3.4.1 Introduction to ULDP Function

Unidirectional link is a common error state of link in networks, especially in fiber links. Unidirectional link means that only one port of the link can receive messages from the other port, while the latter one can not receive messages from the former one. Since the physical layer of the link is connected and works normal, via the checking mechanism of the physical layer, communication problems between the devices can not be found. As shown in Graph, the problem in fiber connection can not be found through mechanisms in physical layer like automatic negotiation.

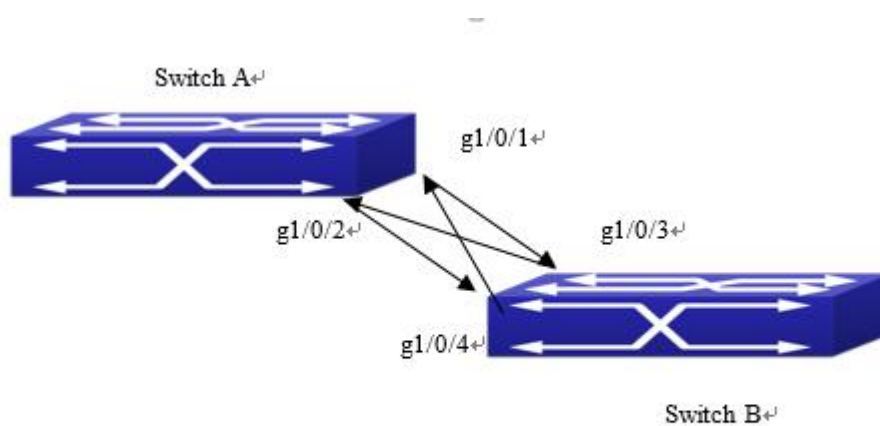

Figure 2-3 Fiber Cross Connection

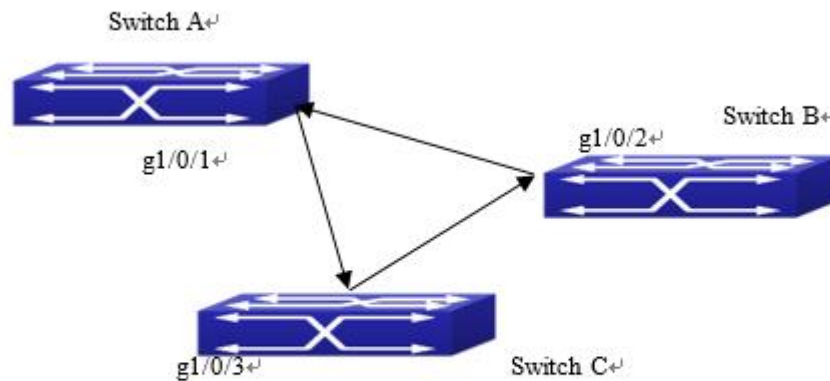

Figure 2-4 One End of Each Fiber Not Connected

This kind of problem often appears in the following situations: GBIC (Giga Bitrate Interface Converter) or interfaces have problems, software problems, hardware becomes unavailable or operates abnormally. Unidirectional link will cause a series of problems, such as spinning tree topological loop, broadcast black hole.

ULDP (Unidirectional Link Detection Protocol) can help avoid disasters that could happen in the situations mentioned above. In a switch connected via fibers or copper Ethernet line (like ultra five-kind twisted pair), ULDP can monitor the link state of physical links. Whenever a unidirectional link is discovered, it will send warnings to users and can disable the port automatically or manually according to users' configuration.

The ULDP of switches recognizes remote devices and check the correctness of link connections via interacting ULDP messages. When ULDP is enabled on a port, protocol state machine will be started, which means different types of messages will be sent at different states of the state machine to check the connection state of the link by exchanging information with remote devices. ULDP can dynamically study the interval at which the remote device sends notification messages and adjust the local TTL (time to live) according to that interval. Besides, ULDP provides the reset mechanism, when the port is disabled by ULDP, it can check again through reset mechanism. The time intervals of notification messages and reset in ULDP can be configured by users, so that ULDP can respond faster to connection errors in different network environments.

The premise of ULDP working normally is that link works in duplex mode, which means ULDP is enabled on both ends of the link, using the same method of authentication and password.

3.4.2 ULDP Configuration Task Sequence

1. Enable ULDP function globally
2. Enable ULDP function on a port
3. Configure aggressive mode globally
4. Configure aggressive mode on a port
5. Configure the method to shut down unidirectional link
6. Configure the interval of Hello messages

7. Configure the interval of Recovery
8. Reset the port shut down by ULDP
9. Display and debug the relative information of ULDP

1. Enable ULDP function globally

Command	Explanation
Global configuration mode	
uldp enable uldp disable	Globally enable or disable ULDP function.

2. Enable ULDP function on a port

Command	Explanation
Port configuration mode	
uldp enable uldp disable	Enable or disable ULDP function on a port.

3. Configure aggressive mode globally

Command	Explanation
Global configuration mode	
uldp aggressive-mode no uldp aggressive-mode	Set the global working mode.

4. Configure aggressive mode on a port

Command	Explanation
Port configuration mode	
uldp aggressive-mode no uldp aggressive-mode	Set the working mode of the port.

5. Configure the method to shut down unidirectional link

Command	Explanation
Global configuration mode	
uldp manual-shutdown no uldp manual-shutdown	Configure the method to shut down unidirectional link.

6. Configure the interval of Hello messages

Command	Explanation
Global configuration mode	
uldp hello-interval <integer> no uldp hello-interval	Configure the interval of Hello messages, ranging from 5 to 100 seconds. The value is 10 seconds by default.

7. Configure the interval of Recovery

Command	Explanation

Global configuration mode	
uldp recovery-time <integer> no uldap recovery-time <integer>	Configure the interval of Recovery reset, ranging from 30 to 86400 seconds. The value is 0 second by default.

8. Reset the port shut down by ULDP

Command	Explanation
Global configuration mode or port configuration mode	
uldp reset	Reset all ports in global configuration mode; Reset the specified port in port configuration mode.

9. Display and debug the relative information of ULDP

Command	Explanation
Admin mode	
show uldp [interface ethernet IFNAME]	Display ULDP information. No parameter means to display global ULDP information. The parameter specifying a port will display global information and the neighbor information of the port.
debug uldp fsm interface ethernet <IFname> no debug uldp fsm interface ethernet <IFname>	Enable or disable the debug switch of the state machine transition information on the specified port.
debug uldp error no debug uldp error	Enable or disable the debug switch of error information.
debug uldp event no debug uldp event	Enable or disable the debug switch of event information.
debug uldp packet {receive send} no debug uldp packet {receive send}	Enable or disable the type of messages can be received and sent on all ports.
debug uldp {hello probe echo unidir all} [receive send] interface ethernet <IFname> no debug uldp {hello probe echo unidir all} [receive send] interface ethernet <IFname>	Enable or disable the content detail of a particular type of messages can be received and sent on the specified port.

3.4.3 ULDP Function Typical Examples

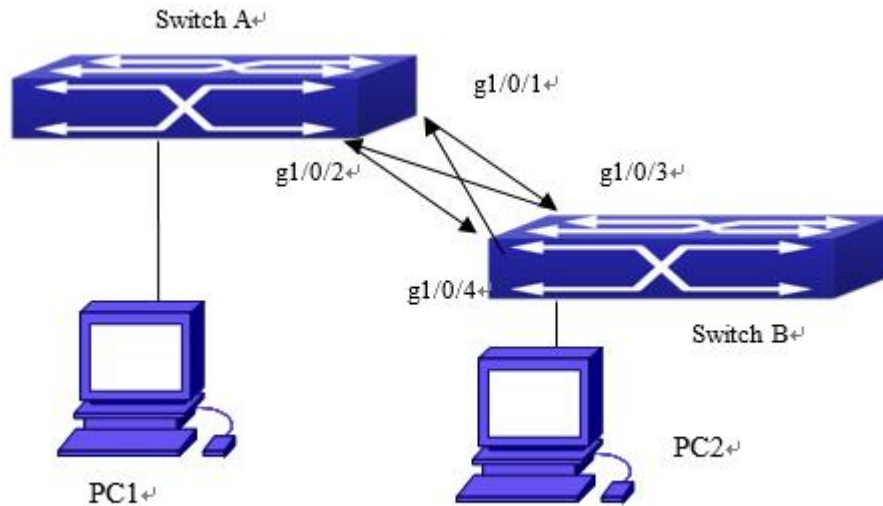

Figure 2- 5 Fiber Cross Connection

In the network topology in Graph, port g1/0/1 and port g1/0/2 of SWITCH A as well as port g1/0/3 and port g1/0/4 of SWITCH B are all fiber ports. And the connection is cross connection. The physical layer is connected and works normally, but the data link layer is abnormal. ULDP can discover and disable this kind of error state of link. The final result is that port g1/0/1, g1/0/2 of SWITCH A and port g1/0/3, g1/0/4 of SWITCH B are all shut down by ULDP. Only when the connection is correct, can the ports work normally (won't be shut down).

Switch A configuration sequence:

```
SwitchA(config)#uldp enable
SwitchA(config)#interface ethernet 1/0/1
SwitchA(Config-If-Ethernet1/0/1)#uldp enable
SwitchA(Config-If-Ethernet1/0/1)#exit
SwitchA(config)#interface ethernet 1/0/2
SwitchA(Config-If-Ethernet1/0/2)#uldp enable
```

Switch B configuration sequence:

```
SwitchB(config)#uldp enable
SwitchB(config)#interface ethernet1/0/3
SwitchB(Config-If-Ethernet1/0/3)#uldp enable
SwitchB(Config-If-Ethernet1/0/3)#exit
SwitchB(config)#interface ethernet 1/0/4
SwitchB(Config-If-Ethernet1/0/4)#uldp enable
```

As a result, port g1/0/1, g1/0/2 of SWITCH A are all shut down by ULDP, and there is notification information on the CRT terminal of PC1.

```
%Oct 29 11:09:50 2007 A unidirectional link is detected! Port Ethernet1/0/1 need to be
shutted down!
```

```
%Oct 29 11:09:50 2007 Unidirectional port Ethernet1/0/1 shut down!
```

```
%Oct 29 11:09:50 2007 A unidirectional link is detected! Port Ethernet1/0/2 need to be
shutted down!
```

%Oct 29 11:09:50 2007 Unidirectional port Ethernet1/0/2 shutted down!

Port g1/0/3, and port g1/0/4 of SWITCH B are all shut down by ULDP, and there is notification information on the CRT terminal of PC2.

%Oct 29 11:09:50 2007 A unidirectional link is detected! Port Ethernet1/0/3 need to be shutted down!

%Oct 29 11:09:50 2007 Unidirectional port Ethernet1/0/3 shutted down!

%Oct 29 11:09:50 2007 A unidirectional link is detected! Port Ethernet1/0/4 need to be shutted down!

%Oct 29 11:09:50 2007 Unidirectional port Ethernet1/0/4 shutted down!

3.4.4 ULDP Troubleshooting

Configuration Notice:

- ☞ In order to ensure that ULDP can discover that the one of fiber ports has not connected or the ports are incorrectly cross connected, the ports have to work in duplex mode and have the same rate.
- ☞ If the automatic negotiation mechanism of the fiber ports with one port misconnected decides the working mode and rate of the ports, ULDP won't take effect no matter enabled or not. In such situation, the port is considered as "Down".
- ☞ In order to make sure that neighbors can be correctly created and unidirectional links can be correctly discovered, it is required that both end of the link should enable ULDP, using the same authentication method and password. At present, no password is needed on both ends.
- ☞ The hello interval of sending hello messages can be changed (it is 10 seconds by default and ranges from 5 to 100 seconds) so that ULDP can respond faster to connection errors of links in different network environments. But this interval should be less than 1/3 of the STP convergence time. If the interval is too long, a STP loop will be generated before ULDP discovers and shuts down the unidirectional connection port. If the interval is too short, the network burden on the port will be increased, which means a reduced bandwidth.
- ☞ ULDP does not handle any LACP event. It treats every link of TRUNK group (like Port-channel, TRUNK ports) as independent, and handles each of them respectively.
- ☞ ULDP does not compact with similar protocols of other vendors, which means users can not use ULDP on one end and use other similar protocols on the other end.
- ☞ ULDP function is disabled by default. After globally enabling ULDP function, the debug switch can be enabled simultaneously to check the debug information. There are several DEBUG commands provided to print debug information, such as information of events, state machine, errors and messages. Different types of message information can also be printed according to different parameters.
- ☞ The Recovery timer is disabled by default and will only be enabled when the users have configured recovery time (30-86400 seconds).
- ☞ Reset command and reset mechanism can only reset the ports automatically shut down by

ULDP. The ports shut down manually by users or by other modules won't be reset by ULDP.

3.5 LLDP

3.5.1 Introduction to LLDP Function

Link Layer Discovery Protocol (LLDP) is a new protocol defined in 802.1ab. It enables neighbor devices to send notices of their own state to other devices, and enables all ports of every device to store information about them. If necessary, the ports can also send update information to the neighbor devices directly connected to them, and those neighbor devices will store the information in standard SNMP MIBs. The network management system can check the layer-two connection state from MIB. LLDP won't configure or control network elements or flows, but only report the configuration of layer-two. Another content of 802.1ab is to utilizing the information provided by LLDP to find the conflicts in layer-two. IEEE now uses the existing physical topology, interfaces and Entity MIBs of IETF.

To simplify, LLDP is a neighbor discovery protocol. It defines a standard method for Ethernet devices, such as switches, routers and WLAN access points, to enable them to notify their existence to other nodes in the network and store the discovery information of all neighbor devices. For example, the detail information of the device configuration and discovery can both use this protocol to advertise.

In specific, LLDP defines a general advertisement information set, a transportation advertisement protocol and a method to store the received advertisement information. The device to advertise its own information can put multiple pieces of advertisement information in one LAN data packet to transport. The type of transportation is the type length value (TLV) field. All devices supporting LLDP have to support device ID and port ID advertisement, but it is assumed that, most devices should also support system name, system description and system performance advertisement. System name and system description advertisement can also provide useful information for collecting network flow data. System description advertisement can include data such as the full name of the advertising device, hardware type of system, the version information of software operation system and so on.

802.1AB Link Layer Discovery Protocol will make searching the problems in an enterprise network an easier process and can strengthen the ability of network management tools to discover and maintain accurate network topology structure.

Many kinds of network management software use "Automated Discovery" function to trace the change and condition of topology, but most of them can reach layer-three and classify the devices into all IP subnets at best. This kind of data are very primitive, only referring to basic events like the adding and removing of relative devices instead of details about where and how these devices operate with the network.

Layer 2 discovery covers information like which devices have which ports, which switches connect to other devices and so on, it can also display the routs between clients, switches, routers,

application servers and network servers. Such details will be very meaningful for schedule and investigate the source of network failure.

LLDP will be a very useful management tool, providing accurate information about network mirroring, flow data and searching network problems.

3.5.2 LLDP Function Configuration Task Sequence

1. Globally enable LLDP function
2. Configure the port-based LLDP function switch
3. Configure the operating state of port LLDP
4. Configure the intervals of LLDP updating messages
5. Configure the aging time multiplier of LLDP messages
6. Configure the sending delay of updating messages
7. Configure the intervals of sending Trap messages
8. Configure to enable the Trap function of the port
9. Configure the optional information-sending attribute of the port
10. Configure the size of space to store Remote Table of the port
11. Configure the type of operation when the Remote Table of the port is full
12. Display and debug the relative information of LLDP

1. Globally enable LLDP function

Command	Explanation
Global Mode	
lldp enable lldp disable	Globally enable or disable LLDP function.

2. Configure the port-base LLDP function switch

Command	Explanation
Port Mode	
lldp enable lldp disable	Configure the port-base LLDP function switch.

3. Configure the operating state of port LLDP

Command	Explanation
Port Mode	
lldp mode (send receive both disable)	Configure the operating state of port LLDP.

4. Configure the intervals of LLDP updating messages

Command	Explanation
Global Mode	
lldp tx-interval <integer> no lldp tx-interval	Configure the intervals of LLDP updating messages as the specified value or default

	value.
--	--------

5. Configure the aging time multiplier of LLDP messages

Command	Explanation
Global Mode	
lldp msgTxHold <value> no lldp msgTxHold	Configure the aging time multiplier of LLDP messages as the specified value or default value.

6. Configure the sending delay of updating messages

Command	Explanation
Global Mode	
lldp transmit delay <seconds> no lldp transmit delay	Configure the sending delay of updating messages as the specified value or default value.

7. Configure the intervals of sending Trap messages

Command	Explanation
Global Mode	
lldp notification interval <seconds> no lldp notification interval	Configure the intervals of sending Trap messages as the specified value or default value.

8. Configure to enable the Trap function of the port

Command	Explanation
Port Configuration Mode	
lldp trap <enable disable>	Enable or disable the Trap function of the port.

9. Configure the optional information-sending attribute of the port

Command	Explanation
Port Configuration Mode	
lldp transmit optional tlv [portDesc] [sysName] [sysDesc] [sysCap] no lldp transmit optional tlv	Configure the optional information-sending attribute of the port as the option value of default values.

10. Configure the size of space to store Remote Table of the port

Command	Explanation
Port Configuration Mode	
lldp neighbors max-num < value > no lldp neighbors max-num	Configure the size of space to store Remote Table of the port as the specified value or default value.

11. Configure the type of operation when the Remote Table of the port is full

Command	Explanation
Port Configuration Mode	
lldp tooManyNeighbors {discard delete}	Configure the type of operation when the Remote Table of the port is full.

12. Display and debug the relative information of LLDP

Command	Explanation
Admin, Global Mode	
show lldp	Display the current LLDP configuration information.
show lldp interface ethernet <IFNAME>	Display the LLDP configuration information of the current port.
show lldp traffic	Display the information of all kinds of counters.
show lldp neighbors interface ethernet <IFNAME >	Display the information of LLDP neighbors of the current port.
show debugging lldp	Display all ports with LLDP debug enabled.
Admin Mode	
debug lldp no debug lldp	Enable or disable the DEBUG switch.
debug lldp packets interface ethernet <IFNAME> no debug lldp packets interface ethernet <IFNAME>	Enable or disable the DEBUG packet-receiving and sending function in port or global mode.
Port configuration mode	
clear lldp remote-table	Clear Remote-table of the port.

3.5.3 LLDP Function Typical Example

Figure 2-6 LLDP Function Typical Configuration Example

In the network topology graph above, the port 1,3 of SWITCH B are connected to port 2,4 of SWITCH A. Port 1 of SWITCH B is configured to message-receiving-only mode, Option TLV of port 4 of SWITCH A is configured as portDes and SysCap.

SWITCH A configuration task sequence:

```
SwitchA(config)#lldp enable
```

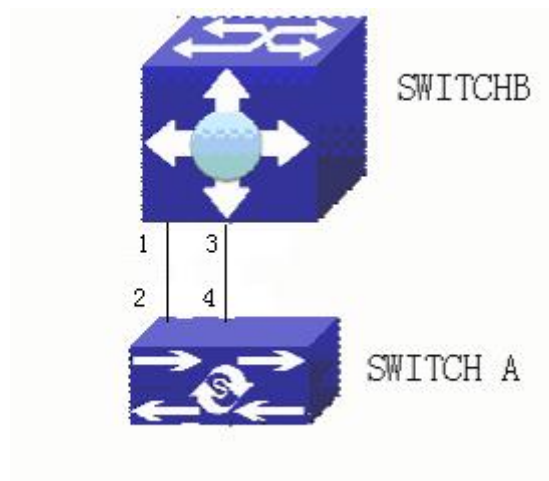
```
SwitchA(config)#interface ethernet 1/0/4
```

```
SwitchA(Config-If-Ethernet1/0/4)#lldp transmit optional tlv portDesc sysCap
```

```
SwitchA(Config-If-Ethernet1/0/4)exit
```

SWITCH B configuration task sequence:

```
SwitchB(config)#lldp enable
```

```
SwitchB(config)#interface ethernet1/0/1
```

```
SwitchB(Config-If-Ethernet1/0/1)#lldp mode receive
```

```
SwitchB(Config-If-Ethernet1/0/1)#exit
```

3.5.4 LLDP Function Troubleshooting

- 👉 LLDP function is disabled by default. After enabling the global switch of LLDP, users can enable the debug switch “**debug lldp**” simultaneously to check debug information.
- 👉 Using “show” function of LLDP function can display the configuration information in global or port configuration mode.

3.6 LLDP-MED

3.6.1 Introduction to LLDP-MED

LLDP-MED (Link Layer Discovery Protocol-Media Endpoint Discovery) based on 802.1AB LLDP (Link Layer Discovery Protocol) of IEEE. LLDP provides a standard link layer discovery mode, it sends local device information (including its major capability, management IP address, device ID and port ID) as TLV (type/length/value) triplets in LLDPDU (Link Layer Discovery Protocol Data Unit) to the direct connection neighbors. The device information received by the neighbors will be stored with a standard management information base (MIB). This allows a network management system to quickly detect and identify the communication status of the link.

In 802.1AB LLDP, there is no transmission and management about the voice device information. To deploy and manage voice device expediently, LLDP-MED TLVs provide multiple information, such as PoE (Power over Ethernet), network policy, and the location information of the emergent telephone service.

3.6.2 LLDP-MED Configuration Task Sequence

1. Basic LLDP-MED configuration

Command	Explanation
Port mode	
lldp transmit med tlv all no lldp transmit med tlv all	Configure the specified port to send all LLDP-MED TLVs. The no command disables the function.
lldp transmit med tlv capability no lldp transmit med tlv capability	Configure the specified port to send LLDP-MED Capability TLV. The no command disables the capability.
lldp transmit med tlv networkPolicy no lldp transmit med tlv networkPolicy	Configure the specified port to send LLDP-MED Network Policy TLV. The no command disables the capability.
lldp transmit med tlv extendPoe no lldp transmit med tlv extendPoe	Configure the specified port to send LLDP-MED Extended Power-Via-MDI TLV. The no command disables the capability.
lldp transmit med tlv location no lldp transmit med tlv location	Configure the specified port to send LLDP-MED Location Identification TLV. The no command disables the capability.
lldp transmit med tlv inventory no lldp transmit med tlv inventory	Configure the port to send LLDP-MED Inventory Management TLVs. The no command disables the capability.
network policy {voice voice-signaling guest-voice guest-voice-signaling softphone-voice video-conferencing streaming-video video-signaling} [status {enable disable}] [tag {tagged untagged}] [vid {<vlan-id> dot1p}] [cos <cos-value>] [dscp <dscp-value>] no network policy {voice voice-signaling guest-voice guest-voice-signaling softphone-voice video-conferencing streaming-video video-signaling}	Configure network policy of the port, including VLAN ID, the supported application (such as voice and video), the application priority and the used policy, and so on.
civic location {dhcp server switch endpointDev}	Configure device type and

<country-code> no civic location	country code of the location with Civic Address LCI format and enter Civic Address LCI address mode. The no command cancels all configurations of the location with Civic Address LCI format.
ecs location <tel-number> no ecs location	Configure the location with ECS ELIN format on the port, the no command cancels the configured location.
lldp med trap {enable disable}	Enable or disable LLDP-MED trap for the specified port.
Civic Address LCI address mode	
{description-language province-state city county street locationNum location floor room postal otherInfo} <address> no {description-language province-state city county street locationNum location floor room postal otherInfo}	Configure the detailed address after enter Civic Address LCI address mode of the port.
Global mode	
lldp med fast count <value> no lldp med fast count	When the fast LLDP-MED startup mechanism is enabled, it needs to fast send the LLDP packets with LLDP-MED TLV, this command is used to set the value of the fast sending packets, the no command restores the default value.
Admin mode	
show lldp	Show the configuration of the global LLDP and LLDP-MED.
show lldp [interface ethernet <IFNAME>]	Show the configuration of LLDP and LLDP-MED on the current port.
show lldp neighbors [interface ethernet <IFNAME>]	Show LLDP and LLDP-MED configuration of the neighbors.
show lldp traffic	Show the statistics of the sent and received packets of port LLDP and LLDP-MED.

3.6.3 LLDP-MED Example

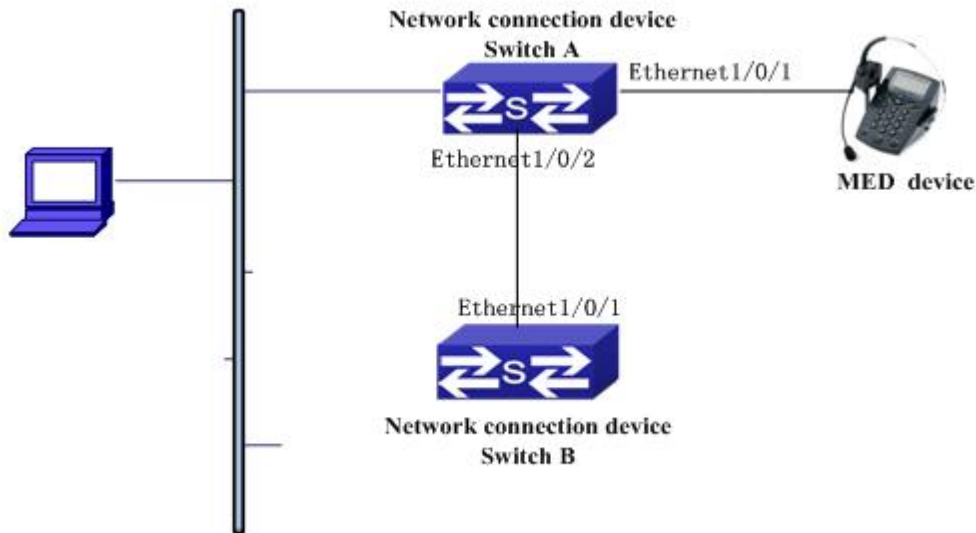

Figure 2-7 Basic LLDP-MED configuration topology

1) Configure Switch A

```
SwitchA(config)#interface ethernet1/0/1
SwitchA (Config-If-Ethernet1/0/1)# lldp enable
SwitchA (Config-If-Ethernet1/0/1)# lldp mode both (this configuration can be omitted, the default
mode is RxTx)
SwitchA (Config-If-Ethernet1/0/1)# lldp transmit med tlv capability
SwitchA (Config-If-Ethernet1/0/1)# lldp transmit med tlv network policy
SwitchA (Config-If-Ethernet1/0/1)# lldp transmit med tlv inventory
SwitchB (Config-If-Ethernet1/0/1)# network policy voice tag tagged vid 10 cos 5 dscp 15
SwitchA (Config-If-Ethernet1/0/1)# exit
SwitchA (config)#interface ethernet1/0/2
SwitchA (Config-If-Ethernet1/0/2)# lldp enable
SwitchA (Config-If-Ethernet1/0/2)# lldp mode both
```

2) Configure Switch B

```
SwitchB (config)#interface ethernet1/0/1
SwitchB(Config-If-Ethernet1/0/1)# lldp enable
SwitchB (Config-If-Ethernet1/0/1)# lldp mode both
SwitchB (Config-If-Ethernet1/0/1)# lldp transmit med tlv capability
SwitchB (Config-If-Ethernet1/0/1)# lldp transmit med tlv network policy
SwitchB (Config-If-Ethernet1/0/1)# lldp transmit med tlv inventory
SwitchB (Config-If-Ethernet1/0/1)# network policy voice tag tagged vid 10 cos 4
```

3) Verify the configuration

Show the global status and interface status on Switch A.

```
SwitchA# show lldp neighbors interface ethernet 1/0/1
```

Port name : Ethernet1/0/1

Port Remote Counter : 1

TimeMark :20

ChassisIdSubtype :4

ChassisId :00-03-0f-00-00-02

PortIdSubtype :Local

PortId :1

PortDesc :****

SysName :****

SysDesc :*****

SysCapSupported :4

SysCapEnabled :4

LLDP MED Information :

MED Codes:

(CAP)Capabilities, (NP) Network Policy

(LI) Location Identification, (PSE)Power Source Entity

(PD) Power Device, (IN) Inventory

MED Capabilities:CAP,NP,PD,IN

MED Device Type: Endpoint Class III

Media Policy Type :Voice

Media Policy :Tagged

Media Policy Vlan id :10

Media Policy Priority :3

Media Policy Dscp :5

Power Type : PD

Power Source :Primary power source

Power Priority :low

Power Value :15.4 (Watts)

Hardware Revision:

Firmware Revision:4.0.1

Software Revision:6.2.30.0

Serial Number:

Manufacturer Name:****

Model Name:Unknown

Assert ID:Unknown

IEEE 802.3 Information :

auto-negotiation support: Supported

auto-negotiation support: Not Enabled

PMD auto-negotiation advertised capability: 1

operational MAU type: 1

SwitchA# show lldp neighbors interface ethernet 1/0/2

Port name : interface ethernet 1/0/2

Port Remote Counter: 1

Neighbor Index: 1

Port name : Ethernet1/0/2

Port Remote Counter : 1

TimeMark :20

```
ChassisIdSubtype :4
ChassisId :00-03-0f-00-00-02
PortIdSubtype :Local
PortId :1
PortDesc :Ethernet1/0/1
SysName :****
SysDesc :*****
```

```
SysCapSupported :4
SysCapEnabled :4
```

Explanation:

- 1) Both Ethernet2 of switch A and Ethernet1 of switch B are the ports of network connection device, they will not send LLDP packets with MED TLV information forwardly. Although configure Ethernet1 of switch B to send MED TLV information, it will not send the related MED information, that results the corresponding Remote table without the related MDE information on Ethernet2 of switch A.
- 2) LLDP-MED device is able to send LLDP packets with MED TLV forwardly, so the corresponding Remote table with LLDP MED information on Ethernet1 of switch A.

3.6.4 LLDP-MED Troubleshooting

If problems occur when configuring LLDP-MED, please check whether the problem is caused by the following reasons:

- 👉 Check whether the global LLDP is enabled.
- 👉 Only network connection device received LLDP packets with LLDP-MED TLV from the near MED device, it sends LLDP-MED TLV. If network connection device configured the command for sending LLDP-MED TLV, the packets also without LLDP-MED TLV sent by the port, that means no MED information is received and the port does not enable the function for sending LLDP-MED information.
- 👉 If neighbor device has sent LLDP-MED information to network connection device, but there is no LLDP-MED information by checking **show lldp neighbors** command, that means LLDP-MED information sent by neighbor is error.

3.7 Port Channel

3.7.1 Introduction to Port Channel

To understand Port Channel, Port Group should be introduced first. Port Group is a group of physical ports in the configuration level; only physical ports in the Port Group can take part in link aggregation and become a member port of a Port Channel. Logically, Port Group is not a port but a port sequence. Under certain conditions, physical ports in a Port Group perform port aggregation to form a Port Channel that has all the properties of a logical port, therefore it becomes an independent logical port. Port aggregation is a process of logical abstraction to abstract a set of ports (port sequence) with the same properties to a logical port. Port Channel is a collection of physical ports and used logically as one physical port. Port Channel can be used as a normal port by the user, and can not only add network's bandwidth, but also provide link backup. Port aggregation is usually used when the switch is connected to routers, PCs or other switches.

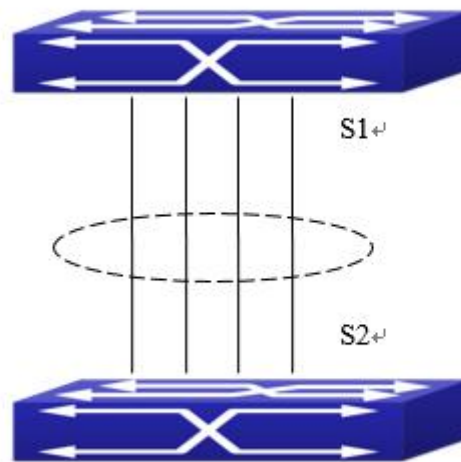

Figure 2-8 Port aggregation

As shown in the above, S1 is aggregated to a Port Channel, the bandwidth of this Port Channel is the total of all the four ports. If traffic from S1 needs to be transferred to S2 through the Port Channel, traffic allocation calculation will be performed based on the source MAC address and the lowest bit of target MAC address. The calculation result will decide which port to convey the traffic. If a port in Port Channel fails, the other ports will undertake traffic of that port through a traffic allocation algorithm. This algorithm is carried out by the hardware.

Switch offers two methods for configuring port aggregation: manual Port Channel creation and LACP (Link Aggregation Control Protocol) dynamic Port Channel creation. Port aggregation can only be performed on ports in full-duplex mode.

For Port Channel to work properly, member ports of the Port Channel must have the same properties as follows:

- ☞ All ports are in full-duplex mode.
- ☞ All Ports are of the same speed.
- ☞ All ports are Access ports and belong to the same VLAN or are all TRUNK ports, or are all Hybrid ports.
- ☞ If the ports are all TRUNK ports or Hybrid ports, then their “Allowed VLAN” and “Native VLAN” property should also be the same.

If Port Channel is configured manually or dynamically on switch, the system will automatically set the port with the smallest number to be Master Port of the Port Channel. If the spanning tree function is enabled in the switch, the spanning tree protocol will regard Port Channel as a logical port and send BPDU frames via the master port.

Port aggregation is closely related with switch hardware. Switch allow physical port aggregation of any two switches, maximum 128 groups and 8 ports in each port group are supported.

Once ports are aggregated, they can be used as a normal port. Switch have a built-in aggregation interface configuration mode, the user can perform related configuration in this mode just like in the VLAN and physical interface configuration mode.

3.7.2 Brief Introduction to LACP

LACP (Link Aggregation Control Protocol) is a kind of protocol based on IEEE802.3ad standard to implement the link dynamic aggregation. LACP protocol uses LACPDU (Link Aggregation Control Protocol Data Unit) to exchange the information with the other end.

After LACP protocol of the port is enabled, this port will send LACPDU to the other end to notify the system priority, the MAC address of the system, the priority of the port, the port ID and the operation Key. After the other end receives the information, the information is compared with the saving information of other ports to select the port which can be aggregated, accordingly, both sides can reach an agreement about the ports join or exit the dynamic aggregation group.

The operation Key is created by LACP protocol according to the combination of configuration (speed, duplex, basic configuration, management Key) of the ports to be aggregated.

After the dynamic aggregation port enables LACP protocol, the management Key is 0 by default. After the static aggregation port enables LACP, the management Key of the port is the same with the ID of the aggregation group.

For the dynamic aggregation group, the members of the same group have the same operation Key, for the static aggregation group, the ports of Active have the same operation Key.

The port aggregation is that multi-ports are aggregated to form an aggregation group, so as to implement the out/in load balance in each member port of the aggregation group and provides the better reliability.

3.7.2.1 Static LACP Aggregation

Static LACP aggregation is enforced by users configuration, and do not enable LACP protocol. When configuring static LACP aggregation, use “on” mode to force the port to enter the aggregation group.

3.7.2.2 Dynamic LACP Aggregation

1. The summary of the dynamic LACP aggregation

Dynamic LACP aggregation is an aggregation created/deleted by the system automatically, it does not allow the user to add or delete the member ports of the dynamic LACP aggregation. The ports which have the same attribute of speed and duplex, are connected to the same device, have

the same basic configuration, can be dynamically aggregated together. Even if only one port can create the dynamic aggregation, that is the single port aggregation. In the dynamic aggregation, LACP protocol of the port is at the enable state.

2. The port state of the dynamic aggregation group

In dynamic aggregation group, the ports have two states: selected or standby. Both selected ports and standby ports can receive and send LACP protocol, but standby ports can not forward the data packets.

Because the limitation of the max port number in the aggregation group, if the current number of the member ports exceeds the limitation of the max port number, then the system of this end will negotiate with the other end to decide the port state according to the port ID. The negotiation steps are as follows:

Compare ID of the devices (the priority of the system + the MAC address of the system). First, compare the priority of the systems, if they are same, then compare the MAC address of the systems. The end with a small device ID has the high priority.

Compare the ID of the ports (the priority of the port + the ID of the port). For each port in the side of the device which has the high device priority, first, compare the priority of the ports, if the priorities are same, then compare the ID of the ports. The port with a small port ID is selected, and the others become the standby ports.

In an aggregation group, the port which has the smallest port ID and is at the selected state will be the master port, the other ports at the selected state will be the member port.

3.7.3 Introduction to Load balance

The current visits and data flow of the network are increasing; the processing capability and calculated strength are both increasing. If the large amount of the data flow is transmitted from one physical port of the switch at the same, it will cause the network congestion. If there are many physical ports of the switch, it will cause the ports wasting. So there is a method which can expand the network device and server bandwidth, increase the throughout, improve the network flexibility and strengthen the data processing, it is Load Balance.

3.7.4 Port Channel Configuration Task List

1. Create a port group in Global Mode
2. Add ports to the specified group from the Port Mode of respective ports
3. Enter load balancing enhanced profile mode
4. Configure Enhanced Load Sharing Configuration Template
5. Enter port channel configuration mode
6. Set the system priority of LACP protocol
7. Set the port priority of the current port in LACP protocol
8. Set the timeout mode of the current port in LACP protocol

1. Creating a port group

Command	Explanation
Global Mode	
port-group <port-group-number> no port-group <port-group-number>	Create or delete a port group.

2. Add physical ports to the port group

Command	Explanation
Port Mode	
port-group <port-group-number> mode {active passive on} no port-group	Add the ports to the port group and set their mode.

3. Enter load balancing enhanced profile mode

Command	Explanation
Global Mode	
load-balance enhanced profile	Enter load-balance enhanced profile mode.

4. Configure Enhanced Load Sharing Configuration Template

Command	Explanation
load-balance enhanced profile mode	
l2 field [dst-mac] [ingress-port] [l2-protocol] [src-mac] [vlan] no l2 field	This command is used to configure the load sharing method for enhanced L2 packets protocol fields at the aggregation port. The 'no' operation of this command restores the default configuration, which means all fields are configured.
ipv4 field [dst-ip] [ingress-port] [l4-dst-port]	This command is used to configure the load

[l4-src-port] [protocol] [src-ip][vlan] no ipv4 field	sharing method for enhanced IPv4 packets protocol fields at the aggregation port. The 'no' operation of this command restores the default configuration, which means all fields are configured.
ipv6 field [dst-ip] [ingress-port] [l4-dst-port] [l4-src-port] [protocol] [src-ip][vlan] no ipv6 field	This command is used to configure the load sharing method for enhanced IPv6 packets protocol fields at the aggregation port. The 'no' operation of this command restores the default configuration, which means all fields are configured.

5. Enter port channel configuration mode

Command	Explanation
Global configuration mode	
interface port-channel <port-channel-number>	Enter port channel configuration mode

6. Set the system priority of LACP protocol

Command	Explanation
Global mode	
lacp system-priority <system-priority> no lacp system-priority	Set the system priority of LACP protocol, the no command restores the default value.

7. Set the port priority of the current port in LACP protocol

Command	Explanation
Port mode	
lacp port-priority <port-priority> no lacp port-priority	Set the port priority in LACP protocol. The no command restores the default value.

8. Set the timeout mode of the current port in LACP protocol

Command	Explanation
Port mode	
lacp timeout {short long} no lacp timeout	Set the timeout mode in LACP protocol. The no command restores the default value.

9. Set I2 only configuration switch

Command	Explanation
load-balance enhanced profile mode	

l2-only {enable disable}	Turn on/off l2 only sharing switch
----------------------------	------------------------------------

3.7.5 Port Channel Examples

Scenario 1: Configuring Port Channel in LACP.

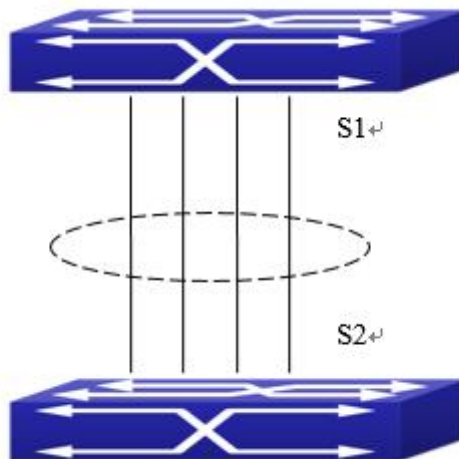

Figure 2-9 Configure Port Channel in LACP

The switches in the description below are all switch and as shown in the figure, ports 1, 2, 3, 4 of S1 are access ports and add them to group1 with active mode. Ports 6, 8, 9, 10 of S2 are access ports and add them to group2 with passive mode. All the ports should be connected with cables.

The configuration steps are listed below:

```
Switch1#config
Switch1(config)#interface ethernet 1/0/1-4
Switch1(Config-If-Port-Range)#port-group 1 mode active
Switch1(Config-If-Port-Range)#exit
Switch1(config)#interface port-channel 1
Switch1(Config-If-Port-Channel1)#

Switch2#config
Switch2(config)#port-group 2
Switch2(config)#interface ethernet 1/0/6
Switch2(Config-If-Ethernet1/0/6)#port-group 2 mode passive
Switch2(Config-If-Ethernet1/0/6)#exit
Switch2(config)#interface ethernet 1/0/8-10
Switch2(Config-If-Port-Range)#port-group 2 mode passive
Switch2(Config-If-Port-Range)#exit
Switch2(config)#interface port-channel 2
```



```
Switch2(Config-If-Port-Channel2)#
```

Configuration result:

Shell prompts ports aggregated successfully after a while, now ports 1, 2, 3, 4 of S1 form an aggregated port named “Port-Channel1”, ports 6, 8, 9, 10 of S2 form an aggregated port named “Port-Channel2”; can be configured in their respective aggregated port mode.

Scenario 2: Configuring Port Channel in ON mode.

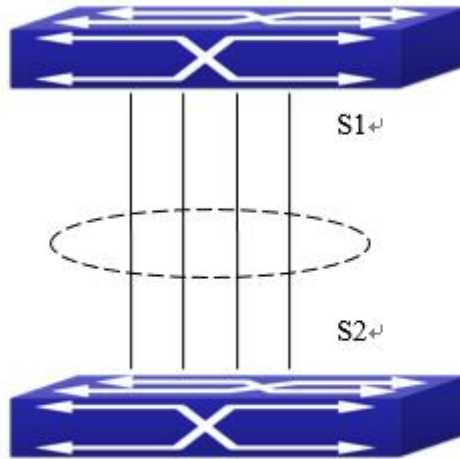

Figure 2- 10 Configure Port Channel in ON mode

As shown in the figure, ports 1, 2, 3, 4 of S1 are access ports and add them to group1 with “on” mode. Ports 6, 8, 9, 10 of S2 are access ports and add them to group2 with “on” mode.

The configuration steps are listed below:

```
Switch1#config
Switch1(config)#interface ethernet 1/0/1
Switch1(Config-If-Ethernet1/0/1)#port-group 1 mode on
Switch1(Config-If-Ethernet1/0/1)#exit
Switch1(config)#interface ethernet 1/0/2
Switch1 (Config-If-Ethernet1/0/2)#port-group 1 mode on
Switch1 (Config-If-Ethernet1/0/2)#exit
Switch1 (config)#interface ethernet 1/0/3
Switch1 (Config-If-Ethernet1/0/3)#port-group 1 mode on
Switch1 (Config-If-Ethernet1/0/3)#exit
Switch1 (config)#interface ethernet 1/0/4
Switch1 (Config-If-Ethernet1/0/4)#port-group 1 mode on
Switch1 (Config-If-Ethernet1/0/4)#exit
```

```
Switch2#config
Switch2(config)#port-group 2
Switch2(config)#interface ethernet 1/0/6
```

```
Switch2 (Config-If-Ethernet1/0/6)#port-group 2 mode on
Switch2 (Config-If-Ethernet1/0/6)#exit
Switch2 (config)#interface ethernet 1/0/8-10
Switch2(Config-If-Port-Range)#port-group 2 mode on
Switch2(Config-If-Port-Range)#exit
```

Configuration result:

Add ports 1, 2, 3, 4 of S1 to port-group1 in order, and we can see a group in 'on' mode is completely joined forcedly, switch in other ends won't exchange LACP PDU to complete aggregation. Aggregation finishes immediately when the command to add port 1/0/2 to port-group 1 is entered, port 1 and port 2 aggregate to be port-channel 1, when port 1/0/3 joins port-group 1, port-channel 1 of port 1 and 2 are ungrouped and re-aggregate with port 3 to form port-channel 1, when port 1/0/4 joins port-group 1, port-channel 1 of port 1, 2 and 3 are ungrouped and re-aggregate with port 4 to form port-channel 1. (It should be noted that whenever a new port joins in an aggregated port group, the group will be ungrouped first and re-aggregated to form a new group.) Now all four ports in both S1 and S2 are aggregated in 'on' mode and become an aggregated port respectively.

3.7.6 Troubleshooting

3.7.6.1 Port Channel Troubleshooting

If problems occur when configuring port aggregation, please first check the following for causes.

- ☞ Ensure all ports in a port group have the same properties, i.e., whether they are in full-duplex mode, forced to the same speed, and have the same VLAN properties, etc. If inconsistency occurs, make corrections.
- ☞ Some commands cannot be used on a port in port-channel, such as arp, bandwidth, ip, ip-forward, etc.

3.7.6.2 Load Balance Troubleshooting

3.8 MTU

3.8.1 Introduction to MTU

So far the Jumbo (Jumbo Frame) has not reach a determined standard in the industry (including the format and length of the frame). Normally frames sized within 1519-12000 should be considered jumbo frame. Networks with jumbo frames will increase the speed of the whole network by 2% to 5%. Technically the Jumbo is just a lengthened frame sent and received by the switch. However considering the length of Jumbo frames, they will not be sent to CPU. We discard the Jumbo frames sent to CPU in the packet receiving process.

3.8.2 MTU Configuration Task Sequence

1. Configure enable MTU function

1. Configure enable MTU function

Command	Explanation
Global Mode	
mtu [<mtu-value>] no mtu enable	Enable the receiving/sending function of MTU frame. The no command disables sending and receiving function of MTU frames.

3.9 bpdu-tunnel

3.9.1 Introduction to bpdu-tunnel

BPDU Tunnel is a Layer 2 tunnel technology. It allows Layer 2 protocol packets of geographically dispersed private network users to be transparently transmitted over specific tunnels across a service provider network.

3.9.1.1 bpdu-tunnel function

In MAN application, multi-branches of a corporation may connect with each other by the service provider network. VPN provided by the service provider enables the geographically dispersed networks to form a local LAN, so the service provider needs to provide the tunnel function, namely, data information generated by user's network is able to inextenso arrive at other networks of the same corporation through the service provider network. To maintain a local concept, it not only needs to transmit the data within the user's private network across the tunnel, but also transmit layer 2 protocol packets within the user's private network.

3.9.1.2 Background of bpdu-tunnel

Special lines are used in a service provider network to build user-specific Layer 2 networks. As a result, a user network is broken down into parts located at different sides of the service provider network. As shown in Figure, User A has two devices (CE 1 and CE 2) and both devices

belong to the same VLAN. User's network is divided into network 1 and network 2, which are connected by the service provider network. When Layer 2 protocol packets cannot implement the passthrough across the service provider network, the user's network cannot process independent Layer 2 protocol calculation (for example, spanning tree calculation), so they affect each other.

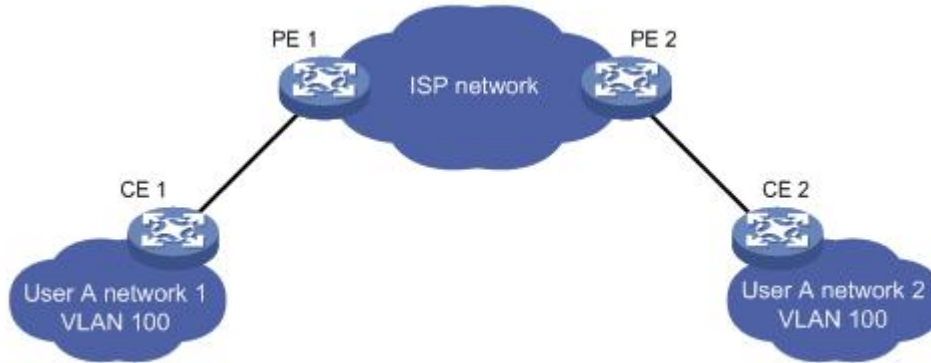

Figure 2- 11 BPDUs Tunnel application

3.9.2 bpdu-tunnel Configuration Task List

bpdu-tunnel-protocol configuration task list:

1. Configure tunnel MAC address globally
2. Configure the port to support the tunnel

1. Configure tunnel MAC address globally

Command	Explanation
Global mode	
bpdu-tunnel-protocol stp default-group-mac no bpdu-tunnel-protocol stp	Configure or cancel the tunnel MAC address globally.

2. Configure the port to support the tunnel

Command	Explanation
Port mode	
bpdu-tunnel-protocol {stp gvrp dot1x user-defined-protocol } no bpdu-tunnel-protocol {stp gvrp dot1x user-defined-protocol }	Enable the port to support the tunnel, the no command disables the function.

3.9.3 Examples of bpdu-tunnel

Special lines are used in a service provider network to build user-specific Layer 2 networks. As a result, a user network is broken down into parts located at different sides of the service provider network. As shown in Figure, User A has two devices (CE 1 and CE 2) and both devices belong to the same VLAN. User's network is divided into network 1 and network 2, which are connected by the service provider network. When Layer 2 protocol packets cannot implement the passthrough across the service provider network, the user's network cannot process independent Layer 2 protocol calculation (for example, spanning tree calculation), so they affect each other.

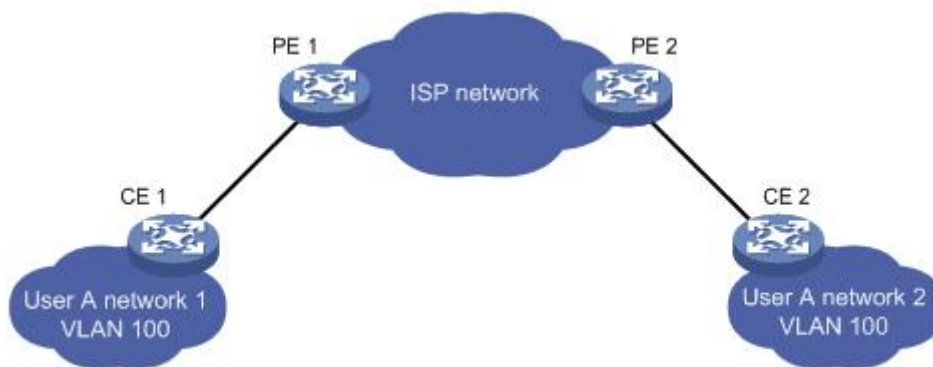

Figure 2- 12 BPDU Tunnel application environment

With BPDU Tunnel, Layer 2 protocol packets from user's networks can be passed through over the service provider network in the following work flow:

1. After receiving a Layer 2 protocol packet from network 1 of user A, PE 1 in the service provider network encapsulates the packet, replaces its destination MAC address with a specific multicast MAC address, and then forwards the packet in the service provider network.
2. The encapsulated Layer 2 protocol packet (called BPDU Tunnel packet) is forwarded to PE 2 at the other end of the service provider network, which de-encapsulates the packet, restores the original destination MAC address of the packet, and then sends the packet to network 2 of user A.

bpdu-tunnel configuration of edge switches PE1 and PE2 in the following:

PE1 configuration:

```
PE1(config-if-ethernet1/1)# bpdu-tunnel-protocol stp
PE1(config-if-ethernet1/1)# bpdu-tunnel-protocol lacp
PE1(config-if-ethernet1/1)# bpdu-tunnel-protocol dot1x
PE2(config-if-ethernet1/1)# bpdu-tunnel-protocol user-defined-protocol uldp
```

PE2 configuration:

```
PE2(config-if-ethernet1/1)# bpdu-tunnel-protocol stp
PE2(config-if-ethernet1/1)# bpdu-tunnel-protocol gvrp
PE2(config-if-ethernet1/1)# bpdu-tunnel-protocol dot1x
PE2(config-if-ethernet1/1)# bpdu-tunnel-protocol user-defined-protocol uldp
bpdu-tunnel
```

3.9.4 bpdu-tunnel Troubleshooting

After port disables stp, gvrp, uldp, lacp and dot1x functions, it is able to configure bpdu-tunnel function.

3.10 DDM

3.10.1 Introduction to DDM

3.10.1.1 Brief Introduction to DDM

DDM (Digital Diagnostic Monitor) makes the detailed digital diagnostic function standard in SFF-8472 MSA. It set that the parameter signal is monitored and make it to digitize on the circuit board of the inner module. After that, providing the demarcated result or the digitize measure result and the demarcate parameter which are saved in the standard memory framework, so as to expediently read by serial interface with double cables.

Normally, intelligent fiber modules support Digital Diagnostic function. Network management units is able to monitor the parameters (temperature, voltage, bias current, tx power and rx power) of the fiber module to obtain theirs thresholds and the real-time state of the current fiber module by the inner MCU of the fiber module. That is able to help the network management units to locate the fault in the fiber link, reduce the maintenance workload and enhance the system reliability.

DDM applications are shown in the following:

1. Module lifetime forecast

Monitoring the bias current is able to forecast the laser lifetime. Administrator is able to find some potential problems by monitoring voltage and temperature of the module.

(1) High Vcc voltage will result in the breakdown CMOS, low Vcc voltage will result in the abnormality work.

(2) High rx power will damage the receiving module, low rx power will result that the receiving module cannot work normally.

(3) High temperature will result in the fast aging of the hardware.

(4) Monitoring the received fiber power to monitor the capability of the link and the remote switch.

2. Fault location

In fiber link, locating the fault is important to the fast overload of the service, fault isolation is able to help administrator to fast locate the location of the link fault within the module (local module or remote module) or on the link, it also reduce the time for restoring the fault of the

system.

Analyzing warning and alarm status of real-time parameters (temperature, voltage, bias current, tx power and rx power) can fast locate the fault through Digital Diagnostic function. Besides, the state of Tx Fault and Rx LOS is important for analyzing the fault.

3. Compatibility verification

Compatibility verification is used to analyze whether the environment of the module accords the data manual or it is compatible with the corresponding standard, because the module capability is able to be ensured only in the compatible environment. Sometimes, environment parameters exceed the data manual or the corresponding standard, it will make the falling of the module capability that result in the transmission error.

Environment is not compatible with the module are as below:

- (1) Voltage exceeds the set range
- (2) Rx power is overload or is under the sensitivity of the transceiver
- (3) Temperature exceeds the range of the running temperature

3.10.1.2 DDM Function

DDM descriptions are shown in the following:

1. Show the monitoring information of the transceiver

Administrator is able to know the current working state of the transceiver and find some potential problems through checking the real-time parameters (including TX power, RX power, Temperature, Voltage, Bias current) and querying the monitoring information (such as warning, alarm, real-time state and threshold, and so on). Besides, checking the fault information of the fiber module helps administrator to fast locate the link fault and saves the restored time.

2. Threshold defined by the user

For real-time parameters (TX power, RX power, Temperature, Voltage, Bias current), there are fixed thresholds. Because the user's environments are difference, the users is able to define the threshold (including high alarm, low alarm, high warn, low warn) to flexibly monitor the working state of the transceiver and find the fault directly.

The thresholds configured by the user and the manufacturer can be shown at the same time. When the threshold defined by the user is irrational, it will prompt the user and automatically process alarm or warning according to the default threshold. (the user is able to restore all thresholds to the default thresholds or restore a threshold to the default threshold)

Threshold rationality: high/low warn should be between high alarm and low alarm and high threshold should be higher than low threshold, namely, $\text{high alarm} \geq \text{high warn} \geq \text{low warn} \geq \text{low alarm}$.

For fiber module, verification mode of the receiving power includes inner verification and outer verification which are decided by the manufacturer. Besides the verification mode of the real-time parameters and the default thresholds are same.

3. Transceiver monitoring

Besides checking the real-time working state of the transceiver, the user needs to monitor the detailed status, such as the former abnormality time and the abnormality type. Transceiver monitoring helps the user to find the former abnormality status through checking the log and query the last abnormality status through executing the commands. When the user finds the abnormality information

of the fiber module, the fiber module information may be remonitored after processing the abnormality information, here, the user is able to know the abnormality information and renew the monitoring.

3.10.2 DDM Configuration Task List

DDM configuration task list:

1. Show the real-time monitoring information of the transceiver
2. Configure the alarm or warning thresholds of each parameter for the transceiver
3. Configure the state of the transceiver monitoring
 - (1) Configure the interval of the transceiver monitoring
 - (2) Configure the enable state of the transceiver monitoring
 - (3) Show the information of the transceiver monitoring
 - (4) Clear the information of the transceiver monitoring

1. Show the real-time monitoring information of the transceiver

Command	Explanation
User mode, admin mode and global mode	
show transceiver [interface ethernet <interface-list>][detail]	Show the monitoring of the transceiver.

2. Configure the alarm or warning thresholds of each parameter for the transceiver

Command	Explanation
Port mode	
transceiver threshold {default {temperature voltage bias rx-power tx-power} {high-alarm low-alarm high-warn low-warn} {<value> default}}	Set the threshold defined by the user.

3. Configure the state of the transceiver monitoring

(1) Configure the interval of the transceiver monitoring

Command	Explanation
Global mode	
transceiver-monitoring interval <minutes> no transceiver-monitoring interval	Set the interval of the transceiver monitor. The no command sets the interval to be the default interval of 15 minutes.

(2) Configure the enable state of the transceiver monitoring

Command	Explanation
Port mode	

transceiver-monitoring {enable disable}	Set whether the transceiver monitoring is enabled. Only the port enables the transceiver monitoring, the system records the abnormality state. After the port disables the function, the abnormality information will be clear.
--	---

(3) Show the information of the transceiver monitoring

Command	Explanation
Admin mode and global mode	
show transceiver threshold-violation [interface ethernet <interface-list>]	Show the information of the transceiver monitoring, including the last threshold-violation information, the interval of the current transceiver monitoring and whether the port enables the transceiver monitoring.

(4) Clear the information of the transceiver monitoring

Command	Explanation
Admin mode	
clear transceiver threshold-violation [interface ethernet <interface-list>]	Clear the threshold violation of the transceiver monitor.

3.10.3 Examples of DDM

Example1:

Ethernet 21 and Ethernet 23 are inserted the fiber module with DDM, Ethernet 24 is inserted the fiber module without DDM, Ethernet 22 does not insert any fiber module, show the DDM information of the fiber module.

a、 Show the information of all interfaces which can read the real-time parameters normally,(No fiber module is inserted or the fiber module is not supported, the information will not be shown), for example:

Switch#show transceiver

Interface	Temp (°C)	Voltage (V)	Bias (mA)	RX Power (dBm)	TX Power (dBm)
1/0/21	33	3.31	6.11	-30.54(A-)	-6.01
1/0/23	33	5.00 (W+)	6.11	-20.54(W-)	-6.02

b、 Show the information of the specified interface. (N/A means no fiber module is inserted or does not support the fiber module), for example:

Switch#show transceiver interface ethernet 1/0/21-22;23

Interface	Temp (°C)	Voltage (V)	Bias (mA)	RX Power (dBm)	TX Power (dBm)
1/0/21	33	3.31	6.11	-30.54(A-)	-6.01
1/0/22	N/A	N/A	N/A	N/A	N/A

1/0/23 33 5.00 (W+) 6.11 -20.54(W-) -6.02

c、 Show the detailed information, including base information, parameter value of the real-time monitoring, warning, alarm, abnormality state, threshold information and the serial number, for example:

Switch#show transceiver interface ethernet 1/0/21-22;24 detail

Ethernet 1/0/21 transceiver detail information:

Base information:

SFP found in this port, manufactured by company, on Sep 29 2010.

Type is 1000BASE-SX. Serial Number is 1108000001.

Link length is 550 m for 50um Multi-Mode Fiber.

Link length is 270 m for 62.5um Multi-Mode Fiber.

Nominal bit rate is 1300 Mb/s, Laser wavelength is 850 nm.

Brief alarm information:

RX loss of signal

Voltage high

RX power low

Detail diagnostic and threshold information:

	Diagnostic		Threshold		
	Realtime Value	High Alarm	Low Alarm	High Warn	Low Warn
	-----	-----	-----	-----	-----
Temperature (°C)	33	70	0	70	0
Voltage (V)	7.31(A+)	5.00	0.00	5.00	0.00
Bias current (mA)	6.11(W+)	10.30	0.00	5.00	0.00
RX Power (dBm)	-30.54(A-)	9.00	-25.00	9.00	-25.00
TX Power (dBm)	-6.01	9.00	-25.00	9.00	-25.00

Ethernet 1/0/22 transceiver detail information: N/A

Ethernet 1/0/24 transceiver detail information:

Base information:

SFP found in this port, manufactured by company, on Sep 29 2010.

Type is 1000BASE-SX. Serial Number is 1108000001.

Link length is 550 m for 50um Multi-Mode Fiber.

Link length is 270 m for 62.5um Multi-Mode Fiber.

Nominal bit rate is 1300 Mb/s, Laser wavelength is 850 nm.

Brief alarm information: N/A

Detail diagnostic and threshold information: N/A

Explanation: If the serial number is 0, it means that it is not specified as bellow:

SFP found in this port, manufactured by company, on Sep 29 2010.

Type is 1000BASE-SX. Serial Number is not specified.

Link length is 550 m for 50um Multi-Mode Fiber.

Link length is 270 m for 62.5um Multi-Mode Fiber.

Nominal bit rate is 1300 Mb/s, Laser wavelength is 850 nm.

Example2:

Ethernet 21 is inserted the fiber module with DDM. Configure the threshold of the fiber module after showing the DDM information.

Step1: Show the detailed DDM information.

```
Switch#show transceiver interface ethernet 1/0/21 detail
```

Ethernet 1/0/21 transceiver detail information:

Base information:

.....

Brief alarm information:

RX loss of signal

Voltage high

RX power low

Detail diagnostic and threshold information:

	Diagnostic			Threshold	
	Realtime Value	High Alarm	Low Alarm	High Warn	Low Warn
Temperature (°C)	33	70	0	70	0
Voltage (V)	7.31(A+)	5.00	0.00	5.00	0.00
Bias current (mA)	6.11(W+)	10.30	0.00	5.00	0.00
RX Power (dBm)	-30.54(A-)	9.00	-25.00	9.00	-25.00
TX Power (dBm)	-13.01	9.00	-25.00	9.00	-25.00

Step2: Configure the tx-power threshold of the fiber module, the low-warning threshold is -12, the low-alarm threshold is -10.00.

```
Switch#config
```

```
Switch(config)#interface ethernet 1/0/21
```

```
Switch(config-if-ethernet1/0/21)#transceiver threshold tx-power low-warning -12
```

```
Switch(config-if-ethernet1/0/21)#transceiver threshold tx-power low-alarm -10.00
```

Step3: Show the detailed DDM information of the fiber module. The alarm uses the threshold configured by the user, the threshold configured by the manufacturer is labeled with the bracket.

There is the alarm with 'A-' due to -13.01 is less than -12.00.

```
Switch#show transceiver interface ethernet 1/0/21 detail
```

Ethernet 1/0/21 transceiver detail information:

Base information:

.....

Brief alarm information:

RX loss of signal

Voltage high

RX power low

TX power low

Detail diagnostic and threshold information:

Diagnostic

Threshold

	Realtime Value	High Alarm	Low Alarm	High Warn	Low Warn
	-----	-----	-----	-----	-----
Temperature (°C)	33	70	0	70	0
Voltage (V)	7.31(A+)	5.00	0.00	5.00	0.00
Bias current (mA)	6.11(W+)	10.30	0.00	5.00	0.00
RX Power (dBm)	-30.54(A-)	9.00	-25.00	9.00	-25.00
TX Power (dBm)	-13.01(A-)	9.00	-12.00(-25.00)	9.00	-10.00(-25.00)

Example3:

Ethernet 21 is inserted the fiber module with DDM. Enable the transceiver monitoring of the port after showing the transceiver monitoring of the fiber module.

Step1: Show the transceiver monitoring of the fiber module. Both ethernet 21 and ethernet 22 do not enable the transceiver monitoring, its interval is set to 30 minutes.

```
Switch(config)#show transceiver threshold-violation interface ethernet 1/0/21-22
```

Ethernet 1/0/21 transceiver threshold-violation information:

Transceiver monitor is disabled. Monitor interval is set to 30 minutes.

The last threshold-violation doesn't exist.

Ethernet 1/0/22 transceiver threshold-violation information:

Transceiver monitor is disabled. Monitor interval is set to 30 minutes.

The last threshold-violation doesn't exist.

Step2: Enable the transceiver monitoring of ethernet 21.

```
Switch(config)#interface ethernet 1/0/21
```

```
Switch(config-if-ethernet1/0/21)#transceiver-monitoring enable
```

Step3: Show the transceiver monitoring of the fiber module. In the following configuration, ethernet 21 enabled the transceiver monitoring, the last threshold-violation time is Jan 02 11:00:50 2011, the detailed DDM information exceeding the threshold is also shown.

```
Switch(config-if-ethernet1/0/21)#quit
```

```
Switch(config)#show transceiver threshold-violation interface ethernet 1/0/21-22
```

Ethernet 1/0/21 transceiver threshold-violation information:

Transceiver monitor is enabled. Monitor interval is set to 30 minutes.

The current time is Jan 02 12:30:50 2011.

The last threshold-violation time is Jan 02 11:00:50 2011.

Brief alarm information:

RX loss of signal

RX power low

Detail diagnostic and threshold information:

	Diagnostic			Threshold	
	Realtime Value	High Alarm	Low Alarm	High Warn	Low Warn
	-----	-----	-----	-----	-----
Temperature (°C)	33	70	0	70	0
Voltage (V)	7.31	10.00	0.00	5.00	0.00

Bias current (mA)	3.11	10.30	0.00	5.00	0.00
RX Power (dBm)	-30.54(A-)	9.00	-25.00(-34)	9.00	-25.00
TX Power (dBm)	-1.01	9.00	-12.05	9.00	-10.00

Ethernet 1/0/22 transceiver threshold-violation information:

Transceiver monitor is disabled. Monitor interval is set to 30 minutes.

The last threshold-violation doesn't exist.

3.10.4 DDM Troubleshooting

If problems occur when configuring DDM, please check whether the problem is caused by the following reasons:

- ☞ Ensure that the transceiver of the fiber module has been inserted fast on the port, or else DDM configuration will not be shown.
- ☞ Ensure that SNMP configuration is valid, or else the warning event cannot inform the network management system.
- ☞ Because only some boards and box switches support SFP with DDM or XFP with DDM, ensure the used board and switch support the corresponding function.
- ☞ When using **show transceiver** command or **show transceiver detail** command, it cost much time due to the switch will check all ports, so it is recommended to query the monitoring information of the transceiver on the specified port.
- ☞ Ensure the threshold defined by the user is valid. When any threshold is error, the transceiver will give an alarm according to the default setting automatically.

3.11 EFM OAM

3.11.1 Introduction to EFM OAM

Ethernet is designed for Local Area Network at the beginning, but link length and network scope is extended rapidly while Ethernet is also applied to Metropolitan Area Network and Wide Area Network along with development. Due to lack the effectively management mechanism, it affects Ethernet application to Metropolitan Area Network and Wide Area Network, implementing OAM on Ethernet becomes a necessary development trend.

There are four protocol standards about Ethernet OAM, they are 802.3ah (EFM OAM), 802.3ag (CFM), E-LMI and Y.1731. EFM OAM and CFM are set for IEEE organization. EFM OAM works in data link layer to validly discover and manage the data link status of rock-bottom. Using EFM OAM can effectively advance management and maintenance for Ethernet to ensure

the stable network operation. CFM is used for monitoring the whole network connectivity and locating the fault in access aggregation network layer. Compare with CFM, Y.1731 standard set by ITU (International Telecommunications Union) is more powerful. E-LMI standard set by MEF is only applied to UNI. So above protocols can be used to different network topology and management, between them exist the complementary relation.

EFM OAM (Ethernet in the First Mile Operation, Administration and Maintenance) works in data link layer of OSI model to implement the relative functions through OAM sublayer, figure is as below:

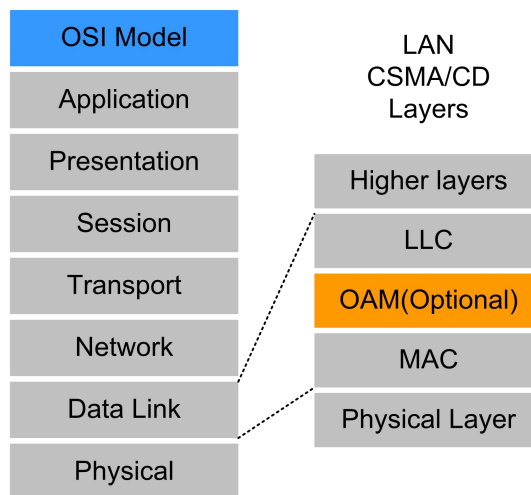

Figure 2- 13 OAM location in OSI model

OAM protocol data units (OAMPDU) use destination MAC address 01-80-c2-00-00-02 of protocol, the max transmission rate is 10Pkt/s.

EFM OAM is established on the basis of OAM connection, it provides a link operation management mechanism such as link monitoring, remote fault detection and remote loopback testing, the simple introduction for EFM OAM in the following:

1. Ethernet OAM connection establishment

Ethernet OAM entity discovers remote OAM entities and establishes sessions with them by exchanging Information OAMPDUs. EFM OAM can operate in two modes: active mode and passive mode. One session can only be established by the OAM entity working in the active mode and ones working in the passive mode need to wait until it receives the connection request. After an Ethernet OAM connection is established, the Ethernet OAM entities on both sides exchange Information OAMPDUs continuously to keep the valid Ethernet OAM connection. If an Ethernet OAM entity receives no Information OAMPDU for five seconds, the Ethernet OAM connection is disconnected.

2. Link Monitoring

Fault detection in an Ethernet is difficult, especially when the physical connection in the network is not disconnected but network performance is degrading gradually. Link monitoring is used to detect and discover link faults in various environments. EFM OAM implements link monitoring through the exchange of Event Notification OAMPDUs. When detecting a link error event, the local OAM entity sends an Event Notification OAMPDU to notify the remote OAM entity. At the same time it will log information and send SNMP Trap to the network management

system. While OAM entity on the other side receives the notification, it will also log and report it. With the log information, network administrators can keep track of network status in time.

The link event monitored by EFM OAM means that the link happens the error event, including Errored symbol period event, Errored frame event, Errored frame period event, Errored frame seconds event.

Errored symbol period event: The errored symbol number can not be less than the low threshold. (Symbol: the min data transmission unit of physical medium. It is unique for coding system, the symbols may be different for different physical mediums, symbol rate means the changed time of electron status per second.)

Errored frame period event: Specifying N is frame period, the errored frame number within the period of receiving N frames can not be less than the low threshold. (Errored frame: Receiving the errored frame detected by CRC.)

Errored frame event: The number of detected error frames over M seconds can not be less than the low threshold.

Errored frame seconds event: The number of error frame seconds detected over M seconds can not be less than the low threshold. (Errored frame second: Receiving an errored frame at least in a second.)

3. Remote Fault Detection

In a network where traffic is interrupted due to device failures or unavailability, the flag field defined in Ethernet OAMPDUs allows an Ethernet OAM entity to send fault information to its peer. As Information OAMPDUs are exchanged continuously across established OAM connections, an Ethernet OAM entity can inform one of its OAM peers of link faults through Information OAMPDUs. Therefore, the network administrator can keep track of link status in time through the log information and troubleshoot in time.

There are three kinds of link faults for Information OAMPDU, they are Critical Event, Dying Gasp and Link Fault, and their definitions are different for each manufacturer, here the definitions are as below:

Critical Event: EFM OAM function of port is disabled.

Link Fault: The number of unidirectional operation or fault can not be less than the high threshold in local. Unidirectional Operation means unidirectional link can not work normally on full-duplex link without autonegotiation. EFM OAM can detect the fault and inform the remote OAM peers through sending Information OAMPDU.

Dying Gasp: There is no definition present. Although device does not generate Dying Gasp OAMPDU, it still receives and processes such OAMPDU sent by its peer.

4. Remote loopback testing

Remote loopback testing is available only after an Ethernet OAM connection is established. With remote loopback enabled, operating Ethernet OAM entity in active mode issues remote loopback requests and the peer responds to them. If the peer operates in loopback mode, it returns all packets except Ethernet OAMPDUs to the senders along the original paths. Performing remote loopback testing periodically helps to detect network faults in time. Furthermore, performing remote loopback testing by network segments helps to locate network faults. Note: The communication will not be processed normally in remote loopback mode.

Typical EFM OAM application topology is in the following, it is used for point-to-point link and emulational IEEE 802.3ah point-to-point link. Device enables EFM OAM through point-to-point connection to monitor the link fault in the First Mile with Ethernet access. For user, the connection between user to telecommunication is “the First Mile”, for service provider, it is “the Last Mile”.

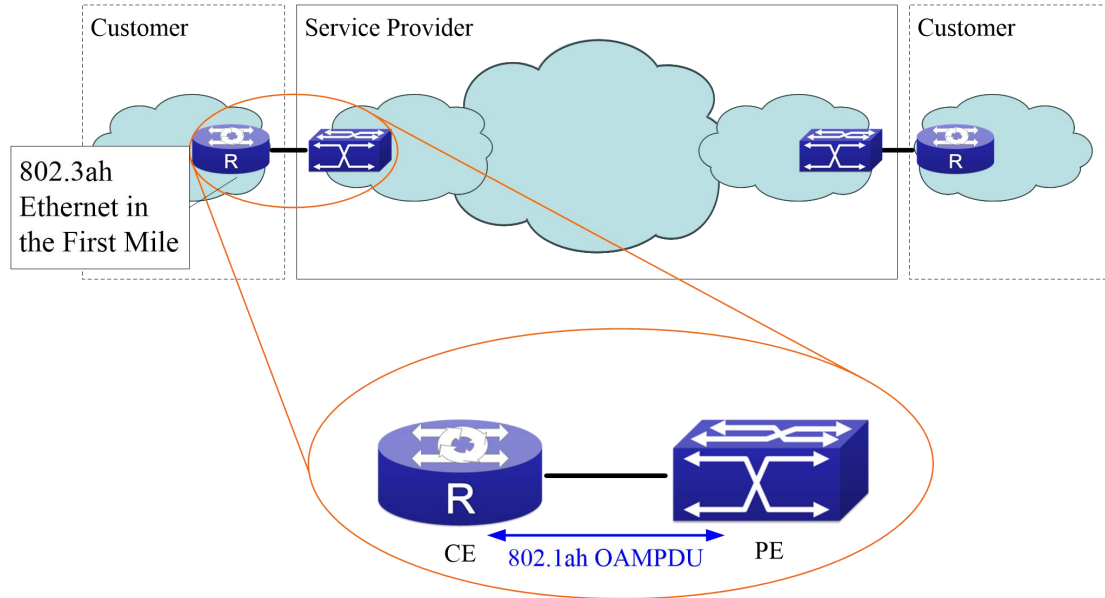

Figure 2-14 Typical OAM application topology

3.11.2 EFM OAM Configuration

EFM OAM configuration task list

1. Enable EFM OAM function of port
2. Configure link monitor
3. Configure remote failure
4. Enable EFM OAM loopback of port

Note: it needs to enable OAM first when configuring OAM parameters.

1. Enable EFM OAM function of port

Command	Explanation
Port mode	
ethernet-oam mode {active passive}	Configure work mode of EFM OAM, default is active mode.
ethernet-oam no ethernet-oam	Enable EFM OAM of port, no command disables EFM OAM of port.
ethernet-oam period <seconds> no ethernet-oam period	Configure transmission period of OAMPDU (optional), no command restores the default value.
ethernet-oam timeout <seconds> no ethernet-oam timeout	Configure timeout of EFM OAM connection, no command restores the

	default value.
--	----------------

2. Configure link monitor

Command	Explanation
Port mode	
ethernet-oam link-monitor no ethernet-oam link-monitor	Enable link monitor of EFM OAM, no command disables link monitor.
ethernet-oam errored-symbol-period {threshold low <low-symbols> window <seconds>} no ethernet-oam errored-symbol-period {threshold low window }	Configure the low threshold and window period of errored symbol period event, no command restores the default value. (optional)
ethernet-oam errored-frame-period {threshold low <low-frames> window <seconds>} no ethernet-oam errored-frame-period {threshold low window }	Configure the low threshold and window period of errored frame period event, no command restores the default value.
ethernet-oam errored-frame {threshold low <low-frames> window <seconds>} no ethernet-oam errored-frame {threshold low window }	Configure the low threshold and window period of errored frame event, no command restores the default value. (optional)
ethernet-oam errored-frame-seconds {threshold low <low-frame-seconds> window <seconds>} no ethernet-oam errored-frame-seconds {threshold low window }	Configure the low threshold and window period of errored frame seconds event, no command restores the default value. (optional)

3. Configure remote failure

Command	Explanation
Port mode	
ethernet-oam remote-failure no ethernet-oam remote-failure	Enable remote failure detection of EFM OAM (failure means critical-event or link-fault event of the local), no command disables the function. (optional)
ethernet-oam errored-symbol-period threshold high {high-symbols none} no ethernet-oam errored-symbol-period threshold high	Configure the high threshold of errored symbol period event, no command restores the default value. (optional)
ethernet-oam errored-frame-period threshold high {high-frames none} no ethernet-oam errored-frame-period threshold high	Configure the high threshold of errored frame period event, no command restores the default value. (optional)
ethernet-oam errored-frame threshold high {high-frames none}	Configure the high threshold of errored frame event, no command

no ethernet-oam errored-frame threshold high	restores the default value. (optional)
ethernet-oam errored-frame-seconds threshold high {high-frame-seconds none}	Configure the high threshold of errored frame seconds event, no command restores the default value. (optional)
no ethernet-oam errored-frame-seconds threshold high	

4. Enable EFM OAM loopback of port

Command	Explanation
Port mode	
ethernet-oam remote-loopback no ethernet-oam remote-loopback	Enable remote EFM OAM entity to enter OAM loopback mode (its peer needs to configure OAM loopback supporting), no command cancels remote OAM loopback.
ethernet-oam remote-loopback supported no ethernet-oam remote-loopback supported	Enable remote loopback supporting of port, no command cancels remote loopback supporting of port.

3.11.3 EFM OAM Example

Example:

CE and PE devices with point-to-point link enable EFM OAM to monitor “the First Mile” link performance. It will report the log information to network management system when occurring fault event and use remote loopback function to detect the link in necessary instance

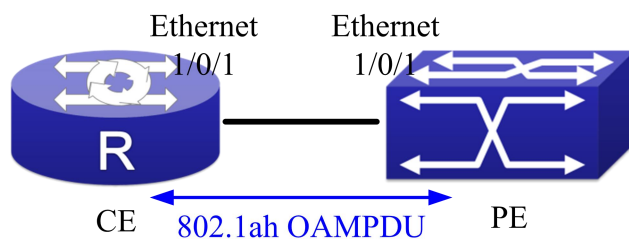

Figure 2- 15 Typical OAM application topology

Configuration procedure: (Omitting SNMP and Log configuration in the following)

Configuration on CE:

```
CE(config)#interface ethernet1/0/1
CE (config-if-ethernet1/0/1)#ethernet-oam mode passive
CE (config-if-ethernet1/0/1)#ethernet-oam
CE (config-if-ethernet1/0/1)#ethernet-oam remote-loopback supported
Other parameters use the default configuration.
```

Configuration on PE:

```
PE(config)#interface ethernet 1/0/1
PE (config-if-ethernet1/0/1)#ethernet-oam
Other parameters use the default configuration.
```

Execute the following command when using remote loopback.

```
PE(config-if-ethernet1/0/1)#ethernet-oam remote-loopback
```

Execute the following command to make one of OAM peers exiting OAM loopback after complete detection.

```
PE(config-if-ethernet1/0/1)# no ethernet-oam remote-loopback
```

Execute the following command without supporting remote loopback.

```
CE(config-if-ethernet1/0/1)#no ethernet-oam remote-loopback supported
```

3.11.4 EFM OAM Troubleshooting

When using EFM OAM, it occurs the problem, please check whether the problem is resulted by the following reasons:

- ☞ Check whether OAM entities of two peers of link in passive mode. If so, EFM OAM connection can not be established between two OAM entities.
- ☞ Ensuring SNMP configuration is correct, or else errored event can not be reported to network management system.
- ☞ Link does not normally communicate in OAM loopback mode, it should cancel remote loopback in time after detect the link performance.
- ☞ Ensuring the used board supports remote loopback function.
- ☞ Port should not configure STP, MRPP, ULPP, Flow Control, loopback detection functions after it enables OAM loopback function, because OAM remote loopback function and these functions are mutually exclusive.

When enabling OAM, the negotiation of the port will be disabled automatically. So the negotiation in the peer of the link must be disabled, otherwise the link connection will unsuccessful. When disabling OAM, the negotiation of the port will be restored. Therefore, to ensure the link connection is normal, the negotiations must be accordant in two peers of the link.

- ☞ After enabling OAM, when the link negotiations in two peers are successful, the state is up. After the fiber in RX redirection of the peer is pulled out, TX of the peer and RX with OAM are normal, so the port with OAM will be at up state all along.

3.12 PORT SECURITY

3.12.1 Introduction to PORT SECURITY

Port security is a MAC address-based security mechanism for network access controlling. It is an extension to the existing 802.1x authentication and MAC authentication. It controls the access of unauthorized devices to the network by checking the source MAC address of the received frame and the access to unauthorized devices by checking the destination MAC address of the sent frame. With port security, you can define various port security modes to make that a device learns only legal source MAC addresses, so as to implement corresponding network security management. After port security is enabled, the device detects an illegal frame, it triggers the corresponding port security feature and takes a pre-defined action automatically. This reduces user's maintenance workload and greatly enhances system security.

3.12.2 PORT SECURITY Configuration Task List

1. Basic configuration for PORT SECURITY

Command	Explanation
Port mode	
switchport port-security no switchport port-security	Configure port-security of the interface.
switchport port-security mac-address <mac-address> [vlan <vlan-id>] no switchport port-security mac-address <mac-address> [vlan <vlan-id>]	Configure the static security MAC of the interface.
switchport port-security maximum <value> [vlan <vlan-list>] no switchport port-security maximum <value> [vlan <vlan-list>]	Configure the maximum number of the security MAC address allowed by the interface.
switchport port-security violation {protect recovery restrict shutdown} no switchport port-security violation	When exceeding the maximum number of the configured MAC addresses, MAC address accessing the interface does not belongs to this interface in MAC address table or a MAC address is configured to several interfaces in same VLAN, both of them will violate the security of the MAC address.
switchport port-security aging {static time <value> type {absolute inactivity}} no switchport port-security violation aging {static time type}	Enable port-security aging entry of the interface, specify aging time or aging type.

Admin mode	
clear port-security {all configured dynamic sticky} [[address <mac-addr> interface <interface-id>] [vlan <vlan-id>]]	Clear the secure MAC entry of the interface.
show port-security [interface <interface-id>] [address vlan]	Show port-security configuration.

3.12.3 Example of PORT SECURITY

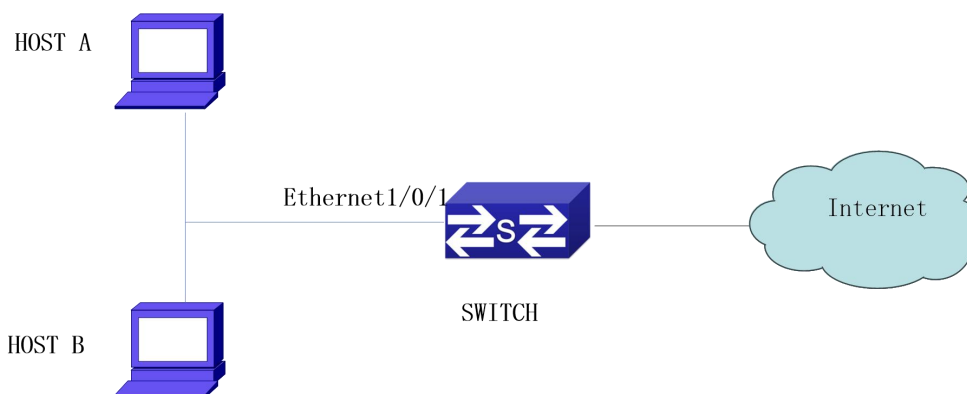

Figure 2- 16 Typical topology chart for port security

When the interface enabled Port security function, configure the maximum number of the secure MAC addresses allowed by a interface to be 10, the interface allows 10 users to access the internet at most. If it exceeds the maximum number, the new user cannot access the internet, so that it not only limit the user's number but also access the internet safely. If configuring the maximum number of the secure MAC addresses as 1, only HOST A or HOST B is able to access the internet.

Configuration process:

#Configure the switch.

```
Switch(config)#interface Ethernet 1/0/1
```

```
Switch(config-if-ethernet1/0/1)#switchport port-security
```

```
Switch(config-if- ethernet1/0/1)#switchport port-security maximum 10
```

```
Switch(config-if- ethernet1/0/1)#exit
```

```
Switch(config)#
```

3.12.4 PORT SECURITY Troubleshooting

If problems occur when configuring PORT SECURITY, please check whether the problem is caused by the following reasons:

- ☞ Check whether PORT SECURITY is enabled normally
- ☞ Check whether the valid maximum number of MAC addresses is configured

3.13 VLAN

3.13.1 Introduction to VLAN

VLAN (Virtual Local Area Network) is a technology that divides the logical addresses of devices within the network to separate network segments basing on functions, applications or management requirements. By this way, virtual workgroups can be formed regardless of the physical location of the devices. IEEE announced IEEE 802.1Q protocol to direct the standardized VLAN implementation, and the VLAN function of switch is implemented following IEEE 802.1Q.

The key idea of VLAN technology is that a large LAN can be partitioned into many separate broadcast domains dynamically to meet the demands.

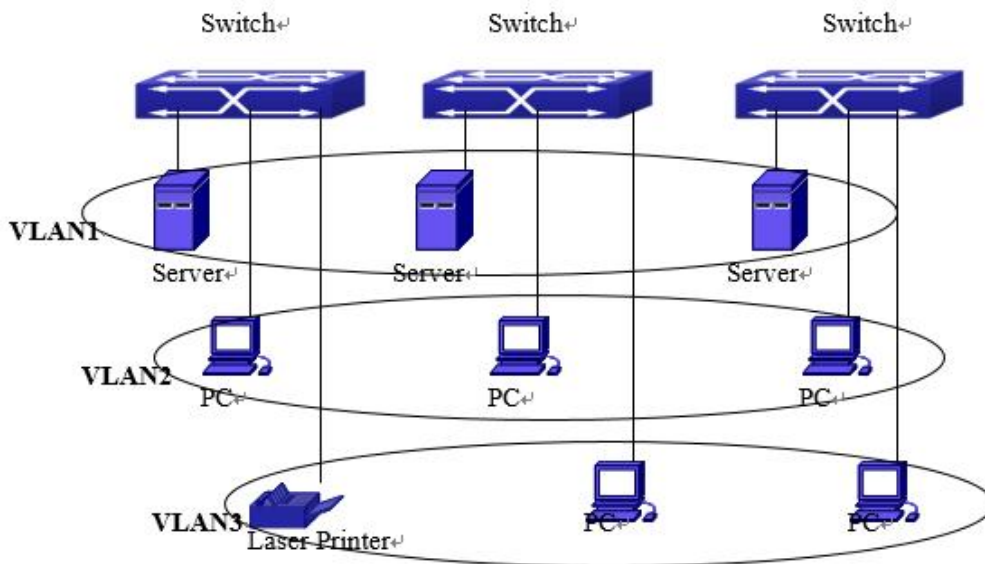

Figure 2- 17 VLAN network defined logically

Each broadcast domain is a VLAN. VLANs have the same properties as the physical LANs, except VLAN is a logical partition rather than physical one. Therefore, the partition of VLANs can be performed regardless of physical locations, and the broadcast, multicast and unicast traffic within a VLAN is separated from the other VLANs.

With the aforementioned features, VLAN technology provides us with the following convenience:

- ↳ Improving network performance
- ↳ Saving network resources
- ↳ Simplifying network management
- ↳ Lowering network cost
- ↳ Enhancing network security

Switch Ethernet Ports can works in three kinds of modes: Access, Hybrid and Trunk, each

mode has a different processing method in forwarding the packets with tagged or untagged.

The ports of Access type only belongs to one VLAN, usually they are used to connect the ports of the computer.

The ports of Trunk type allow multi-VLANs to pass, can receive and send the packets of multi-VLANs. Usually they are used to connect between the switches.

The ports of Hybrid type allow multi-VLANs to pass, can receive and send the packets of multi-VLANs. They can be used to connect between the switches, or to a computer of the user.

Hybrid ports and Trunk ports receive the data with the same process method, but send the data with different method: Hybrid ports can send the packets of multi-VLANs without the VLAN tag, while Trunk ports send the packets of multi-VLANs with the VLAN tag except the port native VLAN.

The switch implements VLAN and GVRP (GARP VLAN Registration Protocol) which are defined by 802.1Q. The chapter will explain the use and the configuration of VLAN and GVRP in detail.

3.13.2 VLAN Configuration Task List

1. Create or delete VLAN
2. Set or delete VLAN name
3. Assign Switch ports for VLAN
4. Set the switch port type
5. Set Trunk port
6. Set Access port
7. Set Hybrid port
8. Enable/Disable VLAN ingress rules on ports
9. Configure Private VLAN
10. Set Private VLAN association
11. Specify internal VLAN ID

1. Create or delete VLAN

Command	Explanation
Global Mode	
vlan WORD no vlan WORD	Create/delete VLAN or enter VLAN Mode

2. Set or delete VLAN name

Command	Explanation
VLAN Mode	
name <vlan-name> no name	Set or delete VLAN name.

3. Assigning Switch ports for VLAN

Command	Explanation
VLAN Mode	
switchport interface <interface-list> no switchport interface <interface-list>	Assign Switch ports to VLAN.

4. Set the Switch Port Type

Command	Explanation
Port Mode	
switchport mode {trunk access hybrid}	Set the current port as Trunk, Access or Hybrid port.

5. Set Trunk port

Command	Explanation
Port Mode	
switchport trunk allowed vlan {WORD all add WORD except WORD remove WORD} no switchport trunk allowed vlan	Set/delete VLAN allowed to be crossed by Trunk. The “no” command restores the default setting.
switchport trunk native vlan <vlan-id> no switchport trunk native vlan	Set/delete PVID for Trunk port.

6. Set Access port

Command	Explanation
Port Mode	
switchport access vlan <vlan-id> no switchport access vlan	Add the current port to the specified VLAN. The “no” command restores the default setting.

7. Set Hybrid port

Command	Explanation
Port Mode	
switchport hybrid allowed vlan {WORD all add WORD except WORD remove WORD} {tag untag} no switchport hybrid allowed vlan	Set/delete the VLAN which is allowed by Hybrid port with tag or untag mode.
switchport hybrid native vlan <vlan-id> no switchport hybrid native vlan	Set/delete PVID of the port.

8. Disable/Enable VLAN Ingress Rules

Command	Explanation
---------	-------------

Port Mode	
vlan ingress enable no vlan ingress enable	Enable/Disable VLAN ingress rules.

9. Configure Private VLAN

Command	Explanation
VLAN mode	
private-vlan {primary isolated community} no private-vlan	Configure current VLAN to Private VLAN. The no command deletes private VLAN.

10. Set Private VLAN association

Command	Explanation
VLAN mode	
private-vlan association <secondary-vlan-list> no private-vlan association	Set/delete Private VLAN association.

11. Specify internal VLAN ID

Command	Explanation
Global mode	
vlan <2-4094> internal	Specify internal VLAN ID.

3.13.3 Typical VLAN Application

Scenario:

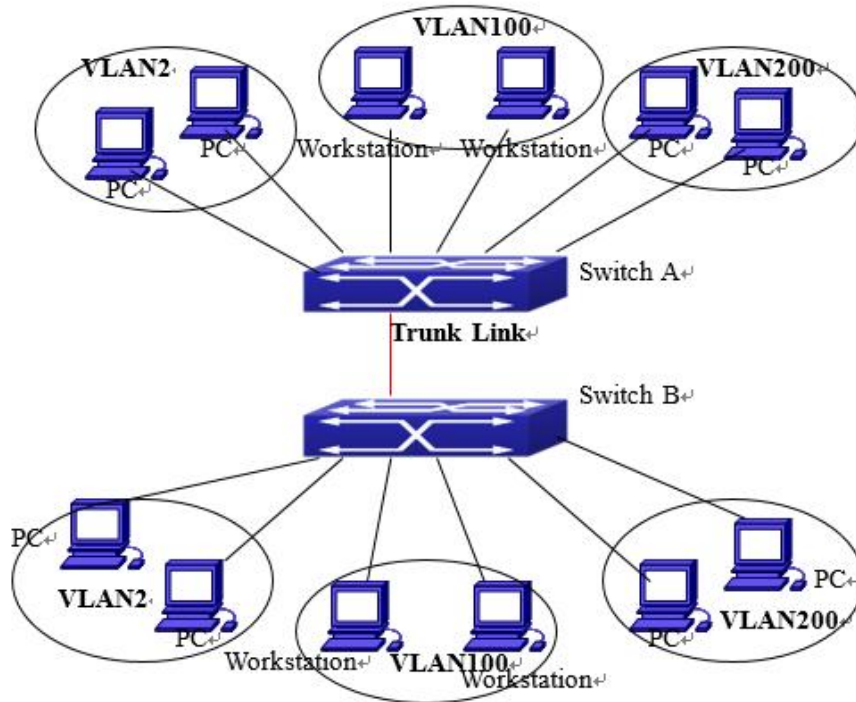

Figure 2- 18 Typical VLAN Application Topology

The existing LAN is required to be partitioned to 3 VLANs due to security and application requirements. The three VLANs are VLAN2, VLAN100 and VLAN200. Those three VLANs are cross two different location A and B. One switch is placed in each site, and cross-location requirement can be met if VLAN traffic can be transferred between the two switches.

Configuration Item	Configuration description
VLAN2	Site A and site B switch port 2-4.
VLAN100	Site A and site B switch port 5-7.
VLAN200	Site A and site B switch port 8-10.
Trunk port	Site A and site B switch port 11.

Connect the Trunk ports of both switches for a Trunk link to convey the cross-switch VLAN traffic; connect all network devices to the other ports of corresponding VLANs.

In this example, port 1 and port 12 are spared and can be used for management port or for other purposes.

The configuration steps are listed below:

Switch A:

```
Switch(config)#vlan 2
```

```
Switch(Config-Vlan2)#switchport interface ethernet 1/0/2-4
```

```
Switch (Config-Vlan2)#exit
```

```
Switch (config)#vlan 100
```

```
Switch (Config-Vlan100)#switchport interface ethernet 1/0/5-7
```

```
Switch (Config-Vlan100)#exit
```

```
Switch (config)#vlan 200
```

```
Switch (Config-Vlan200)#switchport interface ethernet 1/0/8-10
Switch (Config-Vlan200)#exit
Switch (config)#interface ethernet 1/0/11
Switch (Config-If-Ethernet1/0/11)#switchport mode trunk
Switch(Config-If-Ethernet1/0/11)#exit
Switch(config)#
```

Switch B:

```
Switch(config)#vlan 2
Switch(Config-Vlan2)#switchport interface ethernet 1/0/2-4
Switch (Config-Vlan2)#exit
Switch (config)#vlan 100
Switch (Config-Vlan100)#switchport interface ethernet 1/0/5-7
Switch (Config-Vlan100)#exit
Switch (config)#vlan 200
Switch (Config-Vlan200)#switchport interface ethernet 1/0/8-10
Switch (Config-Vlan200)#exit
Switch (config)#interface ethernet 1/0/11
Switch (Config-If-Ethernet1/0/11)#switchport mode trunk
Switch (Config-If-Ethernet1/0/11)#exit
```

3.13.4 Typical Application of Hybrid Port

Scenario:

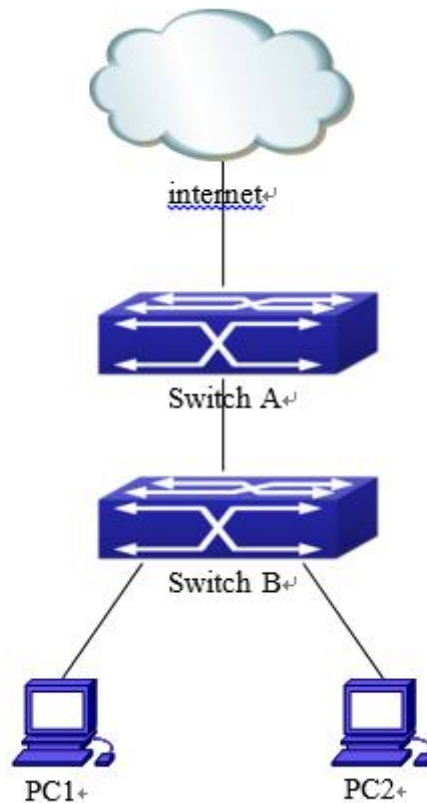

Figure 2- 19 Typical Application of Hybrid Port

PC1 connects to the interface Ethernet 1/0/7 of SwitchB, PC2 connects to the interface Ethernet 1/0/9 of SwitchB, Ethernet 1/0/10 of SwitchA connect to Ethernet 1/0/10 of SwitchB.

It is required that PC1 and PC2 can not mutually access due to reason of the security, but PC1 and PC2 can access other network resources through the gateway SwitchA. We can implement this status through Hybrid port.

Configuration items are as follows:

Port	Type	PVID	the VLANs are allowed to pass
Port 1/0/10 of Switch A	Access	10	Allow the packets of VLAN 10 to pass with untag method.
Port 1/0/10 of Switch B	Hybrid	10	Allow the packets of VLAN 7, 9, 10 to pass with untag method.
Port 1/0/7 of Switch B	Hybrid	7	Allow the packets of VLAN 7, 10 to pass with untag method.
Port 1/0/9 of Switch B	Hybrid	9	Allow the packets of VLAN 9, 10 to pass with untag method.

The configuration steps are listed below:

Switch A:

```
Switch(config)#vlan 10
```

```
Switch(Config-Vlan10)#switchport interface ethernet 1/0/10
```

Switch B:

```
Switch(config)#vlan 7;9;10
Switch(config)#interface ethernet 1/0/7
Switch(Config-If-Ethernet1/0/7)#switchport mode hybrid
Switch(Config-If-Ethernet1/0/7)#switchport hybrid native vlan 7
Switch(Config-If-Ethernet1/0/7)#switchport hybrid allowed vlan 7;10 untag
Switch(Config-If-Ethernet1/0/7)#exit
Switch(Config)#interface Ethernet 1/0/9
Switch(Config-If-Ethernet1/0/9)#switchport mode hybrid
Switch(Config-If-Ethernet1/0/9)#switchport hybrid native vlan 9
Switch(Config-If-Ethernet1/0/9)#switchport hybrid allowed vlan 9;10 untag
Switch(Config-If-Ethernet1/0/9)#exit
Switch(Config)#interface Ethernet 1/0/10
Switch(Config-If-Ethernet1/0/10)#switchport mode hybrid
Switch(Config-If-Ethernet1/0/10)#switchport hybrid native vlan 10
Switch(Config-If-Ethernet1/0/10)#switchport hybrid allowed vlan 7;9;10 untag
Switch(Config-If-Ethernet1/0/10)#exit
```

3.14 GVRP

3.14.1 Introduction to GVRP

GVRP, i.e. GARP VLAN Registration Protocol, is an application of GARP (Generic Attribute Registration Protocol). GARP is mainly used to establish an attribute transmission mechanism to transmit attributes, so as to ensure protocol entities registering and deregistering the attribute. According to different transmission attributes, GARP can be divided to many application protocols, such as GMRP and GVRP. Therefore, GVRP is a protocol which transmits VLAN attributes to the whole layer 2 network through GARP protocol.

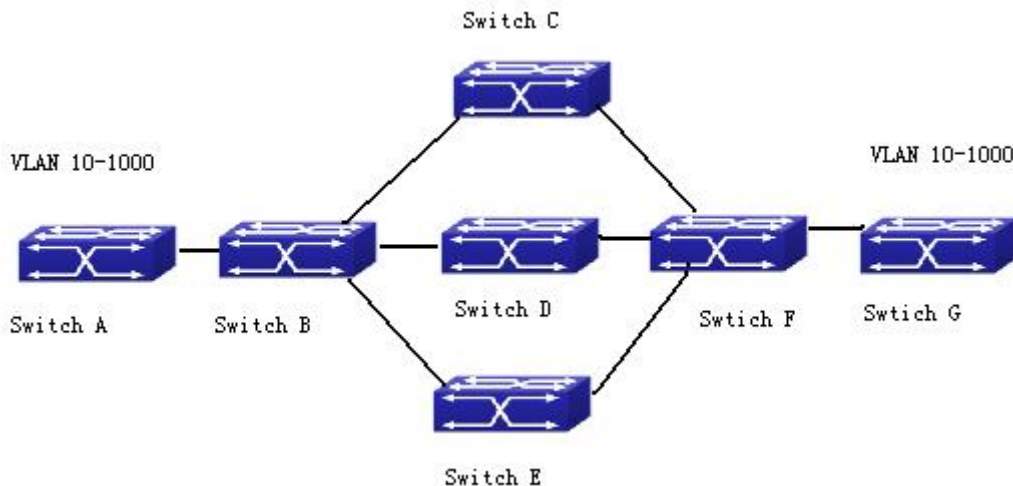

Figure 2-20 a typical application scene

A and G switches are not directly connected in layer 2 network; BCDEF are intermediate switches connecting A and G. Switch A and G configure VLAN100-1000 manually while BCDEF switches do not. When GVRP is not enabled, A and G cannot communicate with each other, because intermediate switches without relevant VLANs. However, after GVRP is enabled on all switches, its VLAN attribute transmission mechanism enables the intermediate switches registering the VLANs dynamically, and the VLAN in VLAN100-1000 of A and G can communicate with each other. The VLANs dynamically registered by intermediate switches will be deregistered when deregistering VLAN100-1000 of A and G switches manually. So the same VLAN of two unadjacent switches can communicate mutually through GVRP protocol instead of configuring each intermediate switch manually for achieving the purpose of simplifying VLAN configuration.

3.14.2 GVRP Configuration Task List

GVRP configuration task list:

1. Configure GVRP timer
2. Configure port type
3. Enable GVRP function

1. Configure GVRP timer

Command	Explanation
Global mode	
garp timer join <200-500> garp timer leave <500-1200> garp timer leaveall <5000-60000> no garp timer (join leave leaveAll)	Configure leaveall, join and leave timer for GVRP.

2. Configure port type

Command	Explanation
Port mode	
gvrp no gvrp	Enable/ disable GVRP function of port.

3. Enable GVRP function

Command	Explanation
Global mode	
gvrp no gvrp	Enable/ disable the global GVRP function of port.

3.14.3 Example of GVRP

GVRP application:

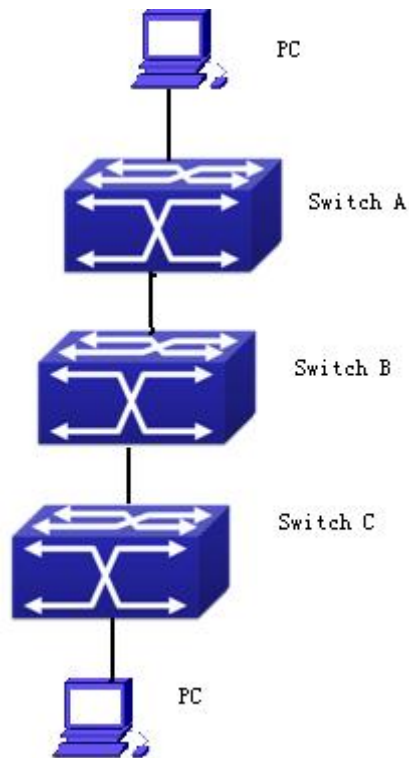

Figure 2-21 Typical GVRP Application Topology

To enable dynamic VLAN information register and update among switches, GVRP protocol is to be configured in the switch. Configure GVRP in Switch A, B and C, enable Switch B to learn VLAN100 dynamically so that two workstations connected to VLAN100 in Switch A and C can communicate with each other through Switch B without static VLAN100 entries.

Configuration Item	Configuration description
VLAN100	Port 2-6 of Switch A and C.
Trunk port	Port 11 of Switch A and C, Port 10, 11 of Switch B.
Global GVRP	Switch A, B, C.
Port GVRP	Port 11 of Switch A and C, Port 10, 11 of Switch B.

Connect two workstations to the VLAN100 ports in switch A and B, connect port 11 of Switch A to port 10 of Switch B, and port 11 of Switch B to port 11 of Switch C.

The configuration steps are listed below:

Switch A:

```
Switch(config)# gvrp
Switch(config)#vlan 100
Switch(Config-Vlan100)#switchport interface ethernet 1/0/2-6
Switch(Config-Vlan100)#exit
Switch(config)#interface ethernet 1/0/11
Switch(Config-If-Ethernet1/0/11)#switchport mode trunk
```

```
Switch(Config-If-Ethernet1/0/11)# gvrp
Switch(Config-If-Ethernet1/0/11)#exit
```

Switch B:

```
Switch(config)#gvrp
Switch(config)#interface ethernet 1/0/10
Switch(Config-If-Ethernet1/0/10)#switchport mode trunk
Switch(Config-If-Ethernet1/0/10)# gvrp
Switch(Config-If-Ethernet1/0/10)#exit
Switch(config)#interface ethernet 1/0/11
Switch(Config-If-Ethernet1/0/11)#switchport mode trunk
Switch(Config-If-Ethernet1/0/11)# gvrp
Switch(Config-If-Ethernet1/0/11)#exit
```

Switch C:

```
Switch(config)# gvrp
Switch(config)#vlan 100
Switch(Config-Vlan100)#switchport interface ethernet 1/0/2-6
Switch(Config-Vlan100)#exit
Switch(config)#interface ethernet 1/0/11
Switch(Config-If-Ethernet1/0/11)#switchport mode trunk
Switch(Config-If-Ethernet1/0/11)# gvrp
Switch(Config-If-Ethernet1/0/11)#exit
```

3.14.4 GVRP Troubleshooting

The GARP counter setting for Trunk ports in both ends of Trunk link must be the same, otherwise GVRP will not work normally. It is recommended to avoid enabling GVRP and RSTP at the same time in switch. If GVRP needs to be enabled, RSTP function for the ports must be disabled first.

3.15 Dot1q-tunnel

3.15.1 Introduction to Dot1q-tunnel

Dot1q-tunnel is also called QinQ (802.1Q-in-802.1Q), which is an expansion of 802.1Q. Its dominating idea is encapsulating the customer VLAN tag (CVLAN tag) to the service provider VLAN tag (SPVLAN tag). Carrying the two VLAN tags the packet is transmitted through the backbone network of the ISP internet, so to provide a simple layer-2 tunnel for the users. It is simple and easy to manage, applicable only by static configuration, and especially adaptive to small office network or small scale metropolitan area network using layer-3 switch as backbone equipment.

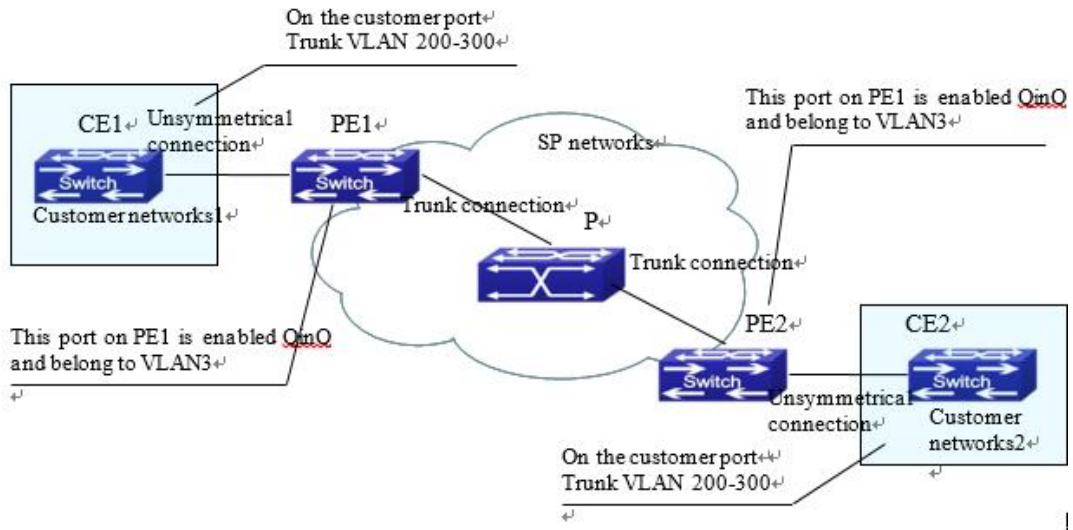

Figure 2-22 Dot1q-tunnel based Internetworking mode

As shown in above, after being enabled on the user port, dot1q-tunnel assigns each user an SPVLAN identification (SPVID). Here the identification of user is 3. Same SPVID should be assigned for the same network user on different PEs. When packet reaches PE1 from CE1, it carries the VLAN tag 200-300 of the user internal network. Since the dot1q-tunnel function is enabled, the user port on PE1 will add on the packet another VLAN tag, of which the ID is the SPVID assigned to the user. Afterwards, the packet will only be transmitted in VLAN3 when traveling in the ISP internet network while carrying two VLAN tags (the inner tag is added when entering PE1, and the outer is SPVID), whereas the VLAN information of the user network is open to the provider network. When the packet reaches PE2 and before being forwarded to CE2 from the client port on PE2, the outer VLAN tag is removed, then the packet CE2 receives is absolutely identical to the one sent by CE1. For the user, the role the operator network plays between PE1 and PE2, is to provide a reliable layer-2 link.

The technology of Dot1q-tunnel provides the ISP internet the ability of supporting many client VLANs by only one VLAN of theirselves. Both the ISP internet and the clients can configure their own VLAN independently.

It is obvious that, the dot1q-tunnel function has got following characteristics:

- ☞ Applicable through simple static configuration, no complex configuration or maintenance to be needed.
- ☞ Operators will only have to assign one SPVID for each user, which increases the number of concurrent supportable users; while the users has got the ultimate freedom in selecting and managing the VLAN IDs (select within 1~4096 at users' will).
- ☞ The user network is considerably independent. When the ISP internet is upgrading their network, the user networks do not have to change their original configuration.

Detailed description on the application and configuration of dot1q-tunnel will be provided in this section.

3.15.2 Dot1q-tunnel Configuration

Configuration Task Sequence of Dot1q-Tunnel:

PE2:

```
Switch(config)#vlan 3
Switch(Config-Vlan3)#switchport interface ethernet 1/0/1
Switch(Config-Vlan3)#exit
Switch(Config)#interface ethernet 1/0/1
Switch(Config-Ethernet1/0/1)# dot1q-tunnel enable
Switch(Config-Ethernet1/0/1)# exit
Switch(Config)#interface ethernet 1/0/10
Switch(Config-Ethernet1/0/10)#switchport mode trunk
Switch(Config-Ethernet1/0/10)#dot1q-tunnel tpid 0x9100
Switch(Config-Ethernet1/0/10)#exit
Switch(Config)#
```

3.15.4 Dot1q-tunnel Troubleshooting

- ☞ Enabling dot1q-tunnel on Trunk port will make the tag of the data packet unpredictable which is not required in the application. So it is not recommended to enable dot1q-tunnel on Trunk port.
- ☞ Enabled with STP/MSTP is not supported.
- ☞ Enabled with PVLAN is not supported.

3.16 VLAN-translation

3.16.1 Introduction to VLAN-translation

VLAN translation, as one can tell from the name, which translates the original VLAN ID to new VLAN ID according to the user requirements so to exchange data across different VLANs. VLAN translation is classified to ingress translation and egress translation, this switch only supports switchover of ingress for VLAN ID.

Application and configuration of VLAN translation will be explained in detail in this section. The access ports of the switch can not support this function.

3.16.2 VLAN-translation Configuration

Configuration task sequence of VLAN-translation:

1. Configure the VLAN-translation function on the port
2. Configure the VLAN-translation relations on the port
3. Configure whether the packet is dropped when checking VLAN-translation is failing
4. Show the related configuration of vlan-translation

1. Configure the VLAN-translation of the port

Command	Explanation
Port mode	
vlan-translation enable no vlan-translation enable	Enter/exit the port VLAN-translation mode.

2. Configure the VLAN-translation relation of the port

Command	Explanation
Port mode	
vlan-translation <old-vlan-id> to <new-vlan-id> in no vlan-translation old-vlan-id in	Add/delete a VLAN-translation relation.

3. Configure whether the packet is dropped when checking VLAN-translation is failing

Command	Explanation
Port mode	
vlan-translation miss drop in no vlan-translation miss drop in	Configure the VLAN-translation packet dropped on port if there is any failure.

4. Show the related configuration of vlan-translation

Command	Explanation
Admin mode	
show vlan-translation	Show the related configuration of vlan-translation.

3.16.3 Typical application of VLAN-translation

Scenario:

Edge switch PE1 and PE2 of the ISP internet support the VLAN20 data task between CE1 and CE2 of the client network with VLAN3. The port1/0/1 of PE1 is connected to CE1, port1/0/10 is connected to public network; port1/0/1 of PE2 is connected to CE2, port1/0/10 is connected to public network.

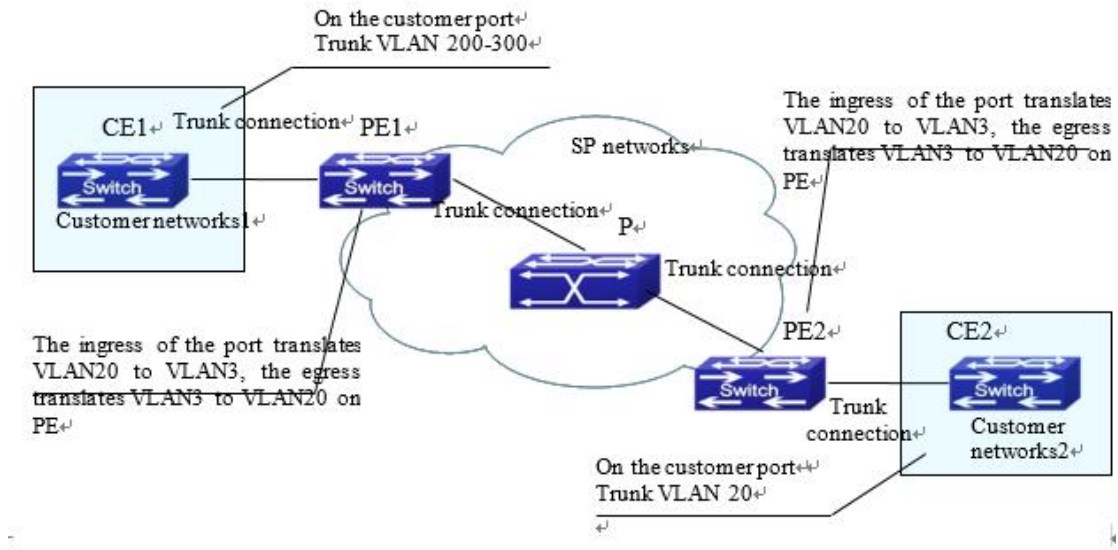

Figure 2-23 Vlan translation topology mode

Configuration Item	Configuration Explanation
VLAN-translation	Port1/0/1 of PE1 and PE2.
Trunk port	Port1/0/1 and Port1/0/10 of PE1 and PE2.

Configuration procedure is as follows:

PE1、PE2:

```

switch(Config)#interface ethernet 1/0/1
switch(Config-Ethernet1/0/1)#switchport mode trunk
switch(Config-Ethernet1/0/1)# vlan-translation enable
switch(Config-Ethernet1/0/1)# vlan-translation 20 to 3 in
switch(Config-Ethernet1/0/1)# vlan-translation 3 to 20 out
switch(Config-Ethernet1/0/1)# exit
switch(Config)#interface ethernet 1/0/10
switch(Config-Ethernet1/0/10)#switchport mode trunk
switch(Config-Ethernet1/0/10)#exit
switch(Config)#

```

3.17 Dynamic VLAN

3.17.1 Introduction to Dynamic VLAN

The dynamic VLAN is named corresponding to the static VLAN (namely the port based VLAN). Dynamic VLAN supported by the switch includes MAC-based VLAN, IP-subnet-based VLAN and Protocol-based VLAN. Detailed description is as follows:

The MAC-based VLAN division is based on the MAC address of each host, namely every host with a MAC address will be assigned to certain VLAN. By the means, the network user will

maintain his membership in his belonging VLAN when moves from a physical location to another. As we can see the greatest advantage of this VLAN division is that the VLAN does not have to be re-configured when the user physic location change, namely shift from one switch to another, which is because it is user based, not switch port based.

The IP subnet based VLAN is divided according to the source IP address and its subnet mask of every host. It assigns corresponding VLAN ID to the data packet according to the subnet segment, leading the data packet to specified VLAN. Its advantage is the same as that of the MAC-based VLAN: the user does not have to change configuration when relocated.

The VLAN is divided by the network layer protocol, assigning different protocol to different VLANs. This is very attractive to the network administrators who wish to organize the user by applications and services. Moreover the user can move freely within the network while maintaining his membership. Advantage of this method enables user to change physical position without changing their VLAN residing configuration, while the VLAN can be divided by types of protocols which is important to the network administrators. Further, this method has no need of added frame label to identify the VLAN which reduce the network traffic.

Notice: Dynamic VLAN needs to associate with Hybrid attribute of the ports to work, so the ports that may be added to a dynamic VLAN must be configured as Hybrid port.

3.17.2 Dynamic VLAN Configuration

Dynamic VLAN Configuration Task Sequence:

1. Configure the MAC-based VLAN function on the port
2. Set the VLAN to MAC VLAN
3. Configure the correspondence between the MAC address and the VLAN
 1. 4. Configure the IP-subnet-based VLAN function on the port
5. Configure the correspondence between the IP subnet and the VLAN
6. Configure the correspondence between the Protocols and the VLAN
7. Adjust the priority of the dynamic VLAN

1. Configure the MAC-based VLAN function on the port

Command	Explanation
Port Mode	
switchport mac-vlan enable no switchport mac-vlan enable	Enable/disable the MAC-based VLAN function on the port.

2. Set the VLAN to MAC VLAN

Command	Explanation
Global Mode	
mac-vlan vlan <vlan-id> no mac-vlan	Configure the specified VLAN to MAC VLAN; the “no mac-vlan” command cancels the MAC VLAN configuration of this VLAN.

3. Configure the correspondence between the MAC address and the VLAN

Command	Explanation
Global Mode	
mac-vlan mac <mac-addrss> <mac-mask> vlan <vlan-id> priority <priority-id> no mac-vlan {mac <mac-addrss> <mac-mask> all}	Add/delete the correspondence between the MAC address and the VLAN, it means to make the specified MAC address join/leave the specified VLAN.

4. Configure the IP-subnet-based VLAN function on the port

Command	Explanation
Port Mode	
switchport subnet-vlan enable no switchport subnet-vlan enable	Enable/disable the port IP-subnet-base VLAN function on the port.

5. Configure the correspondence between the IP subnet and the VLAN

Command	Explanation
Global Mode	
subnet-vlan ip-address <ipv4-addrss> mask <subnet-mask> vlan <vlan-id> priority <priority-id> no subnet-vlan {ip-address <ipv4-addrss> mask <subnet-mask> all}	Add/delete the correspondence between the IP subnet and the VLAN, namely specified IP subnet joins/leaves specified VLAN.

6. Configure the correspondence between the Protocols and the VLAN

Command	Explanation
Global Mode	
protocol-vlan mode {ethernetii etype <etype-id> llc {dsap <dsap-id> ssap <ssap-id>} snap etype <etype-id>} vlan <vlan-id> priority <priority-id> no protocol-vlan {mode {ethernetii etype <etype-id> llc {dsap <dsap-id> ssap <ssap-id>} snap etype <etype-id>} all}	Add/delete the correspondence between the Protocols and the VLAN, namely specified protocol joins/leaves specified VLAN.

7. Adjust the priority of the dynamic VLAN

Command	Explanation
Global Mode	
dynamic-vlan mac-vlan prefer dynamic-vlan subnet-vlan prefer	Configure the priority of the dynamic VLAN.

3.17.3 Typical Application of the Dynamic VLAN

Scenario:

In the office network Department A belongs to VLAN100. Several members of this department often have the need to move within the whole office network. It is also required to ensure the resource for other members of the department to access VLAN 100. Assume one of the members is M, the MAC address of his PC is 00-03-0f-11-22-33, when M moves to VLAN200 or VLAN300, the port connecting M is configured as Hybrid mode and belongs to VLAN100 with untag mode. In this way, the data of VLAN100 will be forwarded to the port connecting M, and implement the communication requirement in VLAN100.

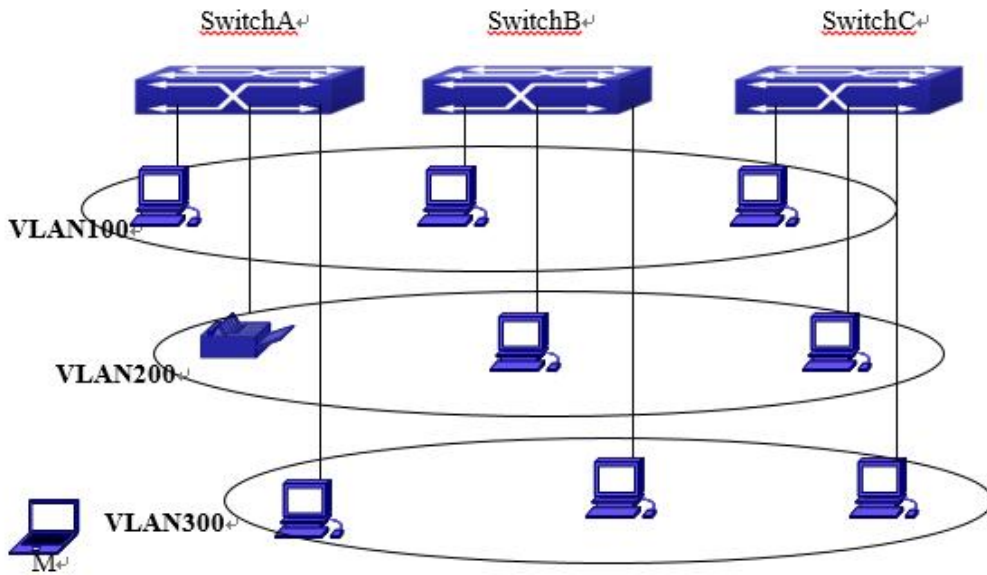

Figure 2-24 Typical topology application of dynamic VLAN

Configuration Items	Configuration Explanation
MAC-based VLAN	Global configuration on Switch A, Switch B, Switch C.

For example, M at E1/0/1 of SwitchA, then the configuration procedures are as follows:

Switch A, Switch B, Switch C:

```
SwitchA (Config)#mac-vlan mac 00-03-0f-11-22-33 vlan 100 priority 0
```

```
SwitchA (Config)#interface ethernet 1/0/1
```

```
SwitchA (Config-Ethernet1/0/1)# swportport mode hybrid
```

```
SwitchA (Config-Ethernet1/0/1)# swportport hybrid allowed vlan 100 untagged
```

```
SwitchB (Config)#mac-vlan mac 00-03-0f-11-22-33 vlan 100 priority 0
```

```
SwitchB (Config)#exit
```

```
SwitchB#
```

```
SwitchC (Config)#mac-vlan mac 00-03-0f-11-22-33 vlan 100 priority 0
```

```
SwitchC (Config)#exit
```

SwitchC#

3.17.4 Dynamic VLAN Troubleshooting

- On the switch configured with dynamic VLAN, if the two connected equipment (e.g. PC) are both belongs to the same dynamic VLAN, first communication between the two equipments may not go through. The solution will be letting the two equipments positively send data packet to the switch (such as ping), to let the switch learn their source MAC, then the two equipments will be able to communicate freely within the dynamic VLAN.

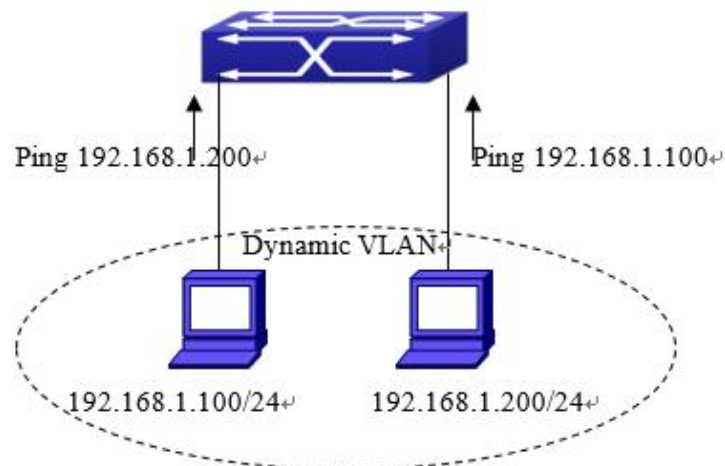

Figure 2-25 Dynamic VLAN Troubleshooting

Priority of dynamic vlan and vlan ingress filtering for processing packets is: dynamic vlan > vlan ingress filtering

3.18 Voice VLAN

3.18.1 Introduction to Voice VLAN

Voice VLAN is specially configured for the user voice data traffic. By setting a Voice VLAN and adding the ports of the connected voice equipments to the Voice VLAN, the user will be able to configure QoS (Quality of service) service for voice data, and improve the voice data traffic transmission priority to ensure the calling quality.

The switch can judge if the data traffic is the voice data traffic from specified equipment according to the source MAC address field of the data packet entering the port. The packet with the source MAC address complying with the system defined voice equipment OUI (Organizationally Unique Identifier) will be considered the voice data traffic and transmitted to the Voice VLAN.

The configuration is based on MAC address, acquiring a mechanism in which every voice equipment transmitting information through the network has got its unique MAC address. VLAN

will trace the address belongs to specified MAC. By This means, VLAN allows the voice equipment always belong to Voice VLAN when relocated physically. The greatest advantage of the VLAN is the equipment can be automatically placed into Voice VLAN according to its voice traffic which will be transmitted at specified priority. Meanwhile, when voice equipment is physically relocated, it still belongs to the Voice VLAN without any further configuration modification, which is because it is based on voice equipment other than switch port.

Notice: Voice VLAN needs to associate with Hybrid attribute of the ports to work, so the ports that may be added to Voice VLAN must be configured as Hybrid port.

3.18.2 Voice VLAN Configuration

Voice VLAN Configuration Task Sequence:

1. Set the VLAN to Voice VLAN
2. Add a voice equipment to Voice VLAN
3. Enable the Voice VLAN on the port

1. Configure the VLAN to Voice VLAN

Command	Explanation
Global Mode	
voice-vlan vlan <vlan-id> no voice-vlan	Set/cancel the VLAN as a Voice VLAN

2. Add a Voice equipment to a Voice VLAN

Command	Explanation
Global Mode	
voice-vlan mac <mac-address> mask <mac-mask> priority <priority-id> [name <voice-name>] no voice-vlan {mac <mac-address> mask <mac-mask> name <voice-name> all}	Specify certain voice equipment join/leave the Voice VLAN

3. Enable the Voice VLAN of the port

Command	Explanation
Port Mode	
switchport voice-vlan enable no switchport voice-vlan enable	Enable/disable the Voice VLAN function on the port

3.18.3 Typical Applications of the Voice VLAN

Scenario:

A company realizes voice communication through configuring Voice VLAN. IP-phone1 and IP-phone2 can be connected to any port of the switch, namely normal communication and interconnected with other switches through the uplink port. IP-phone1 MAC address is 00-03-0f-11-22-33, connect port 1/0/1 of the switch, IP-phone2 MAC address is 00-03-0f-11-22-55, connect port 1/0/2 of the switch.

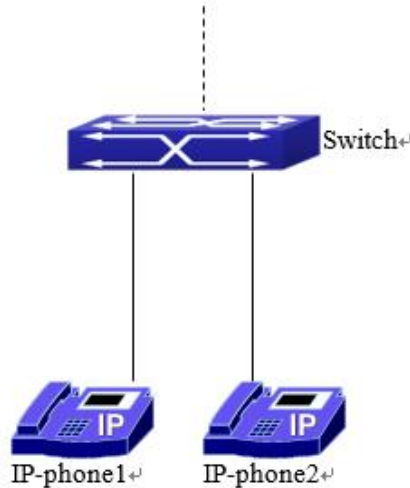

Figure 2-26 VLAN typical apply topology Figure

Configuration items	Configuration Explanation
Voice VLAN	Global configuration on the Switch.

Configuration procedure:

Switch 1:

```
Switch(config)#vlan 100
Switch(Config-Vlan100)#exit
Switch(config)#voice-vlan vlan 100
Switch(config)#voice-vlan mac 00-03-0f-11-22-33 mask 255 priority 5 name company
Switch(config)#voice-vlan mac 00-03-0f-11-22-55 mask 255 priority 5 name company
Switch(config)#interface ethernet 1/0/10
Switch(Config-If-Ethernet1/0/10)#switchport mode trunk
Switch(Config-If-Ethernet1/0/10)#exit
switch(Config)#interface ethernet 1/0/1
switch(Config-If-Ethernet1/0/1)#switchport mode hybrid
switch(Config-If-Ethernet1/0/1)#switchport hybrid allowed vlan 100 untag
switch(Config-If-Ethernet1/0/1)#exit
switch(Config)#interface ethernet 1/0/2
switch(Config-If-Ethernet1/0/2)#switchport mode hybrid
switch(Config-If-Ethernet1/0/2)#switchport hybrid allowed vlan 100 untag
switch(Config-If-Ethernet1/0/2)#exit
```

3.18.4 Voice VLAN Troubleshooting

Voice VLAN can not be applied concurrently with MAC-base VLAN.

3.19 Super VLAN

3.19.1 Introduction to Super VLAN

Super VLAN, also called VLAN aggregation, we introduce the notion of super VLAN and sub VLAN. One or more sub VLANs belong to a super VLAN, and sub VLAN does not occupy an absolute subnet segment any more. However, in the same super VLAN, whether host belongs to any sub VLAN, its IP address is within the subnet segment associated with super VLAN.

In LanSwitch network, VLAN technique is applied widely for advantages (flexible control of broadcast domain and deploy convenience). However, in generic layer-3 switch, it implements communication between broadcast domains through a method that a VLAN correspond to a layer-3 interface, it results in IP address waste.

For example, VLAN division of device is shown in the figure.

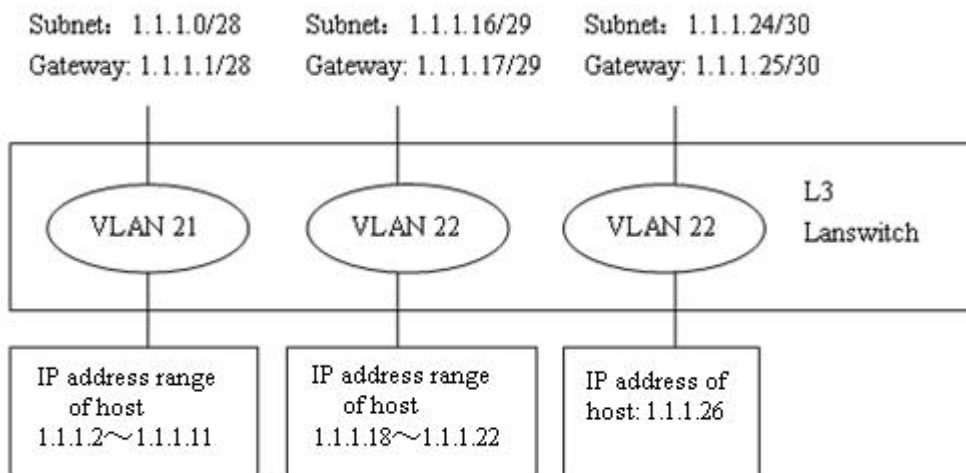

Fig 2-28 generic VLAN network

VLAN	IP Subnet	Gateway Address	Usable Hosts	Customer Hosts	Needed Hosts
21	1.1.1.0/28	1.1.1.1	14	13	10
22	1.1.1.16/29	1.1.1.17	6	5	5
23	1.1.1.24/30	1.1.1.25	2	1	1

Tab 1-1 host address division of generic VLAN

In above table, the needed hosts may be 10 in VLAN 21 and assign a subnet with mask of 28

bits—1.1.1.0/28. However, subnet 1.1.1.0 of network segment, subnet broadcast address 1.1.1.15 and the default gateway address 1.1.1.1 can not become the host address, address range within 1.1.1.2 to 1.1.1.14 can become the host address. So the usable host addresses total is 13 ($2^{32-28}-3=13$), however, only 10 addresses can satisfy the requirement for VLAN21.

The rest may be deduced by analogy, the needed host addresses is 5 for VLAN 22. To satisfy request, it needs to assign a subnet with mask of 29 bits (1.1.1.16/29) for VLAN 22. The needed host address is only 1 for VLAN 23, but it occupies subnet 1.1.1.24/30.

The needed addresses is 16 (10+5+1) for three VLANs, but the excellent method also occupies 28 addresses ($2^{32-28}+2^{32-29}+2^{32-30}=28$) according to address division of generic VLAN, so waste many addresses. Besides, if the needed hosts only reach to 3, but not to 10 hosts, and a subnet with mask of 28 bits is assigned to VLAN 21 before, here, the redundant addresses are wasted because they can not be used by other VLAN.

The above division is difficult to network update. If client of VLAN23 needs to add 2 hosts and client does not want to change the assigned IP address, but the addresses after 1.1.1.24 are assigned to others, so we should assign a subnet with mask of 29 bits and a new VLAN to this client. Here, there are 3 hosts for client of VLAN23 only, but this client is assigned two subnets (they are not in the same VLAN), therefore, it is difficult to management.

We can see that the number of the wasting IP address (such as subnet number, broadcast address, default gateway address) is considerable and badly reduce the addressing flexibility that waste many addresses. Therefore, Super VLAN is developed for solving the problem.

Super VLAN advantages are shown in the following:

Reduce IP address number about subnet number, default gateway address and broadcast address

Implement that the different broadcast domains use addresses of the same subnet segment

Enhance addressing flexibility

Reduce the address waste

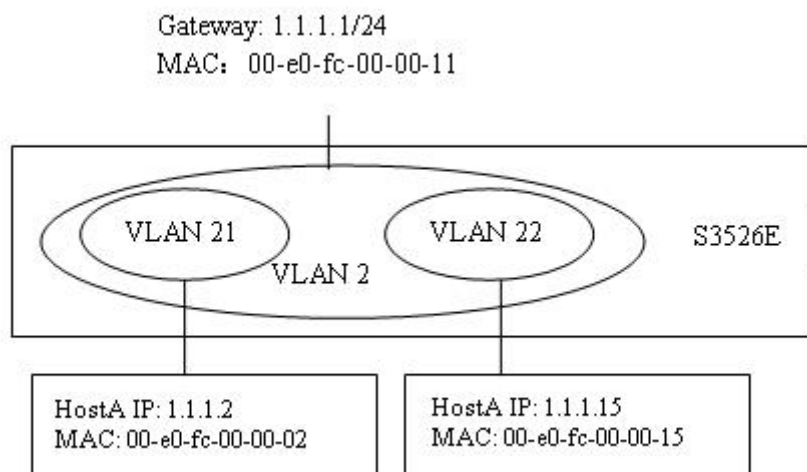

Fig 2-29 super vlan function

Super VLAN is different to the generic VLAN. Super VLAN only create a layer-3 interface and does not include any ports, is a layer-3 notion.

Layer-3 interface of super VLAN is also at UP state as long as there is physical port is at UP state in its sub-VLAN.

3.19.2 Super VLAN Configuration

1. Create or delete supervlan
2. Specify or delete subvlan
3. Enable or disable arp-proxy function of subvlan
4. Specify or delete ip-addr-range of interface
5. Specify or delete ip-addr-range of subvlan

1. Create or delete supervlan

Command	Explanation
VLAN configuration mode	
supervlan no supervlan	Create or delete supervlan.

2. Specify or delete subvlan

Command	Explanation
VLAN configuration mode	
subvlan WORD no subvlan {WORD all}	Specify or delete subvlan.

3. Enable or disable arp-proxy function of subvlan

Command	Explanation
Interface configuration mode	
arp-proxy subvlan {WORD all} no arp-proxy subvlan {WORD all}	Enable or disable arp-proxy function of subvlan.

4. Specify or delete ip-addr-range of interface

Command	Explanation
Interface configuration mode	
ip-addr-range <ipv4-addrss> to <ipv4-addrss> no ip-addr-range	Specify or delete address range of interface.

5. Specify or delete ip-addr-range of subvlan

Command	Explanation
Interface configuration mode	
ip-addr-range subvlan <vlan-id> <ipv4-addrss> to <ipv4-addrss> no ip-addr-range subvlan <vlan-id>	Specify or delete address range of subvlan.

3.19.3 Typical Application of Super VLAN

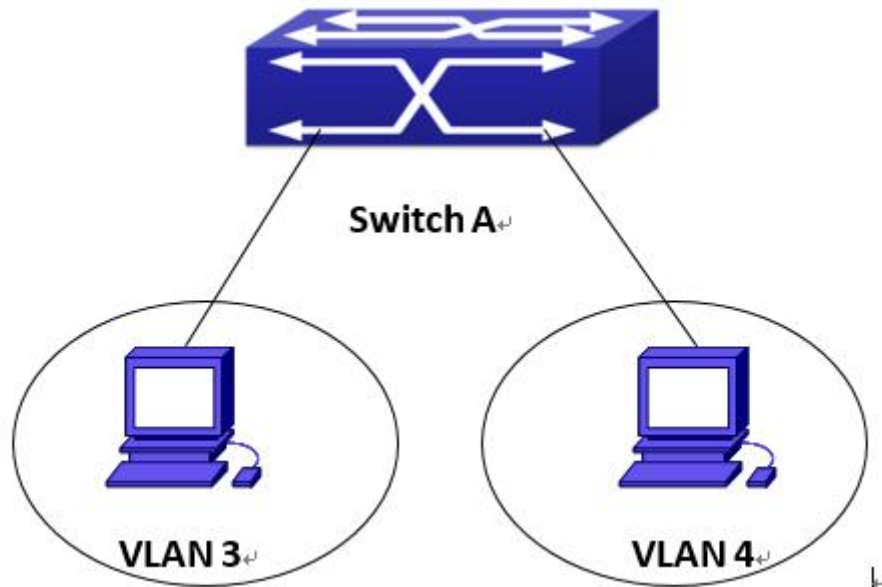

Figure 2-30 typical of super vlan topology

Terminals of two VLANs need to configure their addresses in the same network segment due to the requirement of LAN application. Layer-2 flows need to be isolated, but layer-3 flows can be forwarded normally between two terminals. Address range of VLAN3 from 1.1.1.1 to 1.1.1.10, address range of VLAN4 from 1.1.1.20 to 1.1.1.30, layer-3 flows of terminals within two address ranges allow to be forwarded only. To implement this requirement, it needs to configure supervlan on switch.

Configuration items	Configuration Explanation
VLAN2	Supervlan
VLAN3	Port1 of switchA
VLAN4	Port2 of switchA

Configuration procedure:

Switch A:

```
switch(Config)#vlan 2-4
switch(Config)#vlan 2
switch(Config-Vlan2)#supervlan
switch(Config-Vlan2)#subvlan 3;4
switch(Config-Vlan2)#exit
switch(Config)#interface vlan 2
switch(config-if-vlan2)#ip address 1.1.1.254 255.255.255.0
switch(config-if-vlan2)#arp-proxy subvlan all
switch(config-if-vlan2)#ip-addr-range subvlan 3 1.1.1.1 to 1.1.1.10
```

```
switch(config-if-vlan2)#ip-addr-range subvlan 4 1.1.1.20 to 1.1.1.30
switch(config-if-vlan2)#exit
```

3.19.4 Super VLAN Troubleshooting

- ☞ Supervlan and these functions (VRRP, dynamic VLAN, private VLAN, multicast VLAN, etc.) are mutually exclusive, so they should not be used at the same time.
- ☞ arp-proxy of subvlan takes effect to only one subvlan. Flow received by VLAN with arp-proxy can be forwarded to other VLAN. When two devices send flows to each other at different subvlan, please enable arp-proxy function on two subvlans.
- ☞ Sub vlan can not set layer-3 interface.
- ☞ When creating/deleting supervlan, VLAN needs to ensure no layer-3 interface, if not, it will result in error.
- ☞ If interface of supervlan specifies IP address range, but do not specify address range of subvlan, address range set by interface is standard. If both interface and subvlan specify IP address range, please check whether packets are within subvlan address range firstly, second, check whether packets are within interface address range. After that, packets can be processed other operations.
- ☞ When setting supervlan or subvlan, VLAN must be existed, it can be set.
- ☞ When port mode is set as trunk, it will automatically filter supervlan from allow-vlan.

3.20 MAC Table

3.20.1 Introduction to MAC Table

MAC table is a table identifies the mapping relationship between destination MAC addresses and switch ports. MAC addresses can be categorized as static MAC addresses and dynamic MAC addresses. Static MAC addresses are manually configured by the user, have the highest priority and are permanently effective (will not be overwritten by dynamic MAC addresses); dynamic MAC addresses are entries learnt by the switch in data frame forwarding, and is effective for a limited period. When the switch receives a data frame to be forwarded, it stores the source MAC address of the data frame and creates a mapping to the destination port. Then the MAC table is queried for the destination MAC address, if hit, the data frame is forwarded in the associated port, otherwise, the switch forwards the data frame to its broadcast domain. If a dynamic MAC address is not learnt from the data frames to be forwarded for a long time, the entry will be deleted from the switch MAC table.

There are two MAC table operations:

1. Obtain a MAC address.

- Forward or filter data frame according to the MAC table.

3.20.1.1 Obtaining MAC Table

The MAC table can be built up statically and dynamically. Static configuration is to set up a mapping between the MAC addresses and the ports; dynamic learning is the process in which the switch learns the mapping between MAC addresses and ports, and updates the MAC table regularly. In this section, we will focus on the dynamic learning process of MAC table.

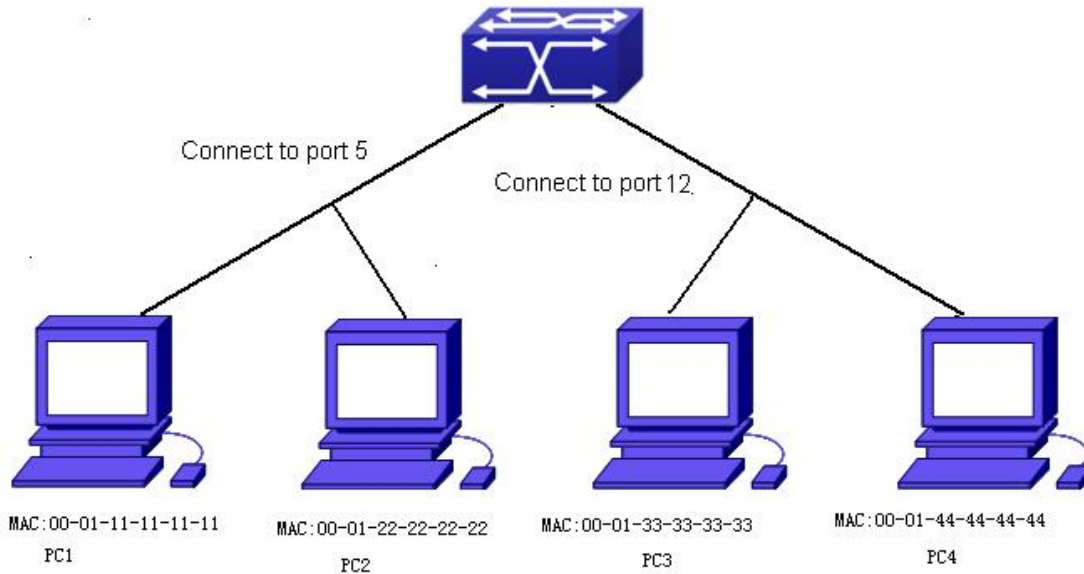

Figure 2-31 MAC Table dynamic learning

The topology of the figure above: 4 PCs connected to switch, where PC1 and PC2 belongs to a same physical segment (same collision domain), the physical segment connects to port 1/0/5 of switch; PC3 and PC4 belongs to the same physical segment that connects to port 1/0/12 of switch.

The initial MAC table contains no address mapping entries. Take the communication of PC1 and PC3 as an example, the MAC address learning process is as follow:

- When PC1 sends message to PC3, the switch receives the source MAC address 00-01-11-11-11-11 from this message, the mapping entry of 00-01-11-11-11-11 and port 1/0/5 is added to the switch MAC table.
- At the same time, the switch learns the message is destined to 00-01-33-33-33-33, as the MAC table contains only a mapping entry of MAC address 00-01-11-11-11-11 and port 1/0/5, and no port mapping for 00-01-33-33-33-33 present, the switch broadcast this message to all the ports in the switch (assuming all ports belong to the default VLAN1).
- PC3 and PC4 on port 1/0/12 receive the message sent by PC1, but PC4 will not reply, as the destination MAC address is 00-01-33-33-33-33, only PC3 will reply to PC1. When port 1/0/12 receives the message sent by PC3, a mapping entry for MAC address 00-01-33-33-33-33 and port 1/0/12 is added to the MAC table.
- Now the MAC table has two dynamic entries, MAC address 00-01-11-11-11-11 - port 1/0/5 and 00-01-33-33-33-33 - port 1/0/12.

- After the communication between PC1 and PC3, the switch does not receive any message sent from PC1 and PC3. And the MAC address mapping entries in the MAC table are deleted in 300 to 2*300 seconds (ie, in single to double aging time). The 300 seconds here is the default aging time for MAC address entry in switch. Aging time can be modified in switch.

3.20.1.2 Forward or Filter

The switch will forward or filter received data frames according to the MAC table. Take the above figure as an example, assuming switch have learnt the MAC address of PC1 and PC3, and the user manually configured the mapping relationship for PC2 and PC4 to ports. The MAC table of switch will be:

MAC Address	Port number	Entry added by
00-01-11-11-11-11	1/0/5	Dynamic learning
00-01-22-22-22-22	1/0/5	Static configuration
00-01-33-33-33-33	1/0/12	Dynamic learning
00-01-44-44-44-44	1/0/12	Static configuration

- Forward data according to the MAC table
If PC1 sends a message to PC3, the switch will forward the data received on port 1/0/5 from port1/0/12.
- Filter data according to the MAC table
If PC1 sends a message to PC2, the switch, on checking the MAC table, will find PC2 and PC1 are in the same physical segment and filter the message (i.e. drop this message).

Three types of frames can be forwarded by the switch:

- 👉 Broadcast frame
- 👉 Multicast frame
- 👉 Unicast frame

The following describes how the switch deals with all the three types of frames:

- Broadcast frame:** The switch can segregate collision domains but not broadcast domains. If no VLAN is set, all devices connected to the switch are in the same broadcast domain. When the switch receives a broadcast frame, it forwards the frame in all ports. When VLANs are configured in the switch, the MAC table will be adapted accordingly to add VLAN information. In this case, the switch will not forward the received broadcast frames in all ports, but forward the frames in all ports in the same VLAN.
- Multicast frame:** For the unknown multicast, the switch will broadcast it in the same vlan, but the switch only forwards the multicast frames to the multicast group's port if IGMP Snooping function or the static multicast group has been configured.
- Unicast frame:** When no VLAN is configured, if the destination MAC addresses are in the switch MAC table, the switch will directly forward the frames to the associated ports; when the destination MAC address in a unicast frame is not found in the MAC table, the switch will broadcast the unicast frame. When VLANs are configured, the switch will

forward unicast frame within the same VLAN. If the destination MAC address is found in the MAC table but belonging to different VLANs, the switch can only broadcast the unicast frame in the VLAN it belongs to.

3.20.2 Mac Address Table Configuration Task List

1. Configure the MAC address aging-time
 2. Configure static MAC forwarding or filter entry
 3. Clear dynamic address table
 4. Configure MAC learning through CPU control
- Configure bucket size for MAC address table

1. Configure the MAC aging-time

Command	Explanation
Global Mode	
mac-address-table aging-time <0> <i>aging-time</i> no mac-address-table aging-time	Configure the MAC address aging-time.

2. Configure static MAC forwarding or filter entry

Command	Explanation
Global Mode	
mac-address-table {static static-multicast blackhole} address <mac-addr> vlan <vlan-id > [interface [ethernet portchannel] <interface-name>] [source destination both] no mac-address-table {static static-multicast blackhole dynamic} [address <mac-addr>] [vlan <vlan-id>] [interface [ethernet portchannel] <interface-name>]	Configure static MAC entries, static multicast MAC entries, filter address entries.

3. Clear dynamic address table

Command	Explanation
Admin Mode	
clear mac-address-table dynamic [address <mac-addr>] [vlan <vlan-id>] [interface [ethernet portchannel] <interface-name>]	Clear the dynamic address table.

4. Configure MAC learning through CPU control

Command	Explanation

Global Mode	
mac-address-learning cpu-control no mac-address-learning cpu-control	Enable MAC learning through CPU control, the no command restores that the chip automatically learn MAC address.
show collision-mac-address-table	Show the hash collision mac table.
Admin Mode	
clear collision-mac-address-table	Clear the hash collision mac table.

5. Configure bucket size for MAC address table

Command	Explanation
Global Mode	
mac-address-table bucket size <1-4>	Sets the bucket size for MAC address table, to improve the learning performance of random mac address.

3.20.3 Typical Configuration Examples

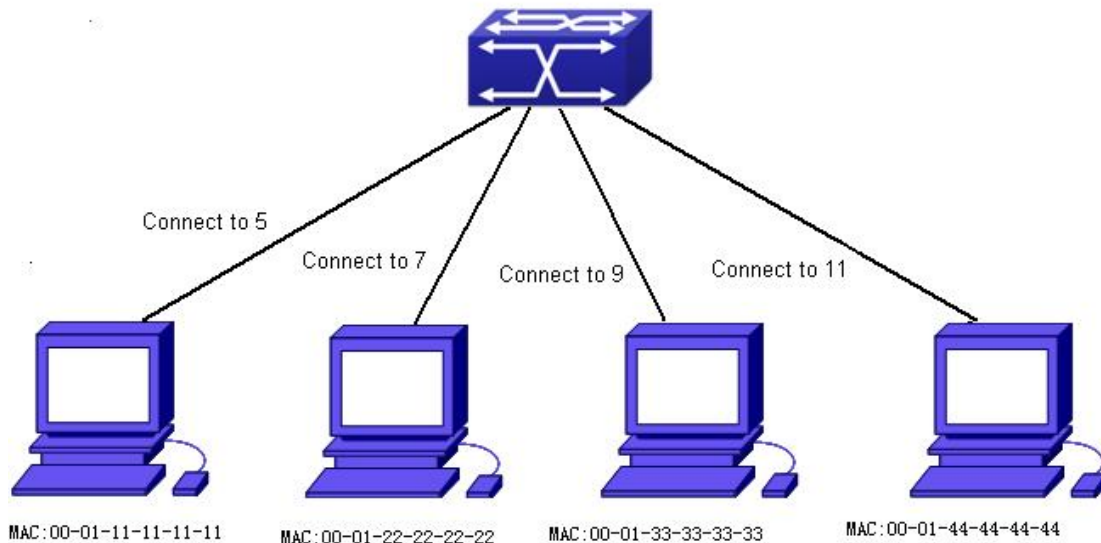

Figure 2-32 MAC Table typical configuration example

Scenario:

Four PCs as shown in the above figure connect to port 1/0/5, 1/0/7, 1/0/9, 1/0/11 of switch, all the four PCs belong to the default VLAN1. As required by the network environment, dynamic learning is enabled. PC1 holds sensitive data and can not be accessed by any other PC that is in another physical segment; PC2 and PC3 have static mapping set to port 1/0/7 and port 1/0/9, respectively.

The configuration steps are listed below:

1. Set the MAC address 00-01-11-11-11-11 of PC1 as a filter address.
Switch(config)#mac-address-table static 00-01-11-11-11-11 discard vlan 1.

2. Set the static mapping relationship for PC2 and PC3 to port 1/0/7 and port 1/0/9, respectively.
Switch(config)#mac-address-table static address 00-01-22-22-22-22 vlan 1 interface ethernet 1/0/7
Switch(config)#mac-address-table static address 00-01-33-33-33-33 vlan 1 interface ethernet 1/0/9

3.20.4 MAC Table Troubleshooting

Using the show mac-address-table command, a port is found to be failed to learn the MAC of a device connected to it. Possible reasons:

- ✎ The connected cable is broken.
- ✎ Spanning Tree is enabled and the port is in “discarding” status; or the device is just connected to the port and Spanning Tree is still under calculation, wait until the Spanning Tree calculation finishes, and the port will learn the MAC address.
- ✎ If not the problems mentioned above, please check for the switch port and contact technical support for solution.

3.21 Rmon

3.21.1 Rmon introduction

RMON provides statistics and alarm functions and is used to remotely monitor and manage managed devices on the network. The statistics function enables the managed device to collect statistics periodically or continuously on the traffic information on the network segment connected to the port, for example, the total number of received packets on a network segment within a certain period of time or the total number of received extremely long packets. The alarm function enables the managed device to monitor the value of a specified MIB variable. When the value reaches the alarm threshold (for example, the port rate or the proportion of broadcast packets), the managed device can automatically record logs and send Trap messages to the managed device.

Both RMON and SNMP are used for remote network management. SNMP is the basis of RMON implementation, and RMON is an enhancement of SNMP function. RMON uses the SNMP Trap sending mechanism to send Trap messages to management devices to inform them of alarm variable exceptions. Although SNMP also defines the Trap function, it is used to inform the managed devices of whether a function is running properly and the change of the physical status of interfaces. The monitored objects, trigger conditions, and report contents are different.

RMON enables SNMP to monitor remote network devices more effectively and proactively, and provides an efficient means for monitoring the operation of subnets. The RMON protocol provides that the managed device can automatically send Trap messages when the alarm threshold is reached. Therefore, the managed device does not need to

obtain MIB variable values for multiple times for comparison. In this way, the communication traffic between the managed device and the managed device can be reduced and the large interconnection network can be easily and effectively managed.

Multiple RMON groups are defined in the RMON specification (RFC2819). The device implements the statistics, history, event, and alarm groups supported in the public MIB.

1. Statistical Group. The statistics group provides that the system will continuously collect statistics on various traffic information of ports (currently, statistics are only supported for Ethernet ports) and store the statistics results in the Ethernet statistics table (etherStatsTable) for management devices to view at any time. Statistics include the number of network conflicts, number of CRC error packets, number of too small (or too large) data packets, number of broadcast and multicast packets, number of received bytes, and number of received packets.

After a statistics entry is successfully created on a specified interface, the statistics group collects statistics on the number of packets on the current interface. The statistics result is a continuous cumulative value.

2. History team. According to the history group, the system collects statistics on various traffic information of ports periodically and stores the statistics in the HistoryTable for management devices to view at any time. Statistics include bandwidth usage, number of error packets, and total packets.

The history group collects statistics on the packets received by a port in each period. You can set the period by running commands.

3. The event group. Event groups are used to define event index numbers and event processing methods. Events defined by event groups are used in alarm group configuration items and extended alarm group configuration items. When the monitored object reaches the alarm condition, an event is triggered. You can handle the event in the following ways:

(1) Log: Records event information (such as event occurrence and event content) in the event Log table of the RMON MIB of the local device, so that the management device can view the event through SNMP GET.

(2) Trap: Sends a Trap message to the NMS to inform the event.

(3) Log-Trap: Logs are recorded on the local device and Trap messages are sent to the NMS.

(4) None: You don't do anything.

4. The alarm set. RMON Alarm management monitors a specified alarm variable (for example, etherStatsPkts, the total number of packets received by a port in the statistics group). After an alarm entry is defined, the system obtains the value of the monitored alarm variable at a specified period. When the value of an alarm variable is greater than or equal to the upper threshold, an upper threshold alarm event is generated. When the

value of an alarm variable is less than or equal to the lower threshold, a lower threshold alarm event is triggered, and alarm management processes the event based on the event definition.

3.21.2 Rmon configuration

The RMON task configuration task sequence is as follows:

1. Enable RMON
2. Configure the RMON statistics group
3. Configure the RMON history group
4. Configure the RMON event group
5. Configure the RMON alarm group
6. The configuration and result are displayed

1.Enable RMON

command	explain
Global configuration mode	
rmon enable no rmon enable	Enable RMON. The no command disables the RMON function

2. Configure the RMON statistics group

command	explain
Global configuration mode	
rmon statistics <I-65535> (ethernet IFNAME IFNAME) (owner WORD) no rmon statistics <I-65535>	Configure the RMON statistics group. The no operation of this command deletes the RMON statistics group

3. Configure the RMON history group

command	explain
Global configuration mode	
rmon history <I-65535> (ethernet IFNAME IFNAME) (buckets <I-100>) (interval <5-3600>) (owner WORD) no rmon history <I-65535>	Configure the RMON history group. The no operation of this command deletes the RMON history group

4. Configure the RMON event group

command	explain
Global configuration mode	
rmon event <I-65535> (description NAME) type (log trap WORD log-trap WORD none) (owner WORD) no rmon event <I-65535>	Configure the RMON event group. The no operation of this command deletes the RMON event group

5. Configure the RMON alarm group

command	explain

Global configuration mode	
rmon alarm <i><1-65535></i> OID <i>interval</i> <i><5-3600></i> (<i>absolute delta</i>) rising-threshold <i>WORD</i> <i><1-65535></i> falling-threshold <i>WORD</i> <i><1-65535></i> startup-alarm <i>(rising falling risingorfalling)</i> (<i>owner</i> <i>NAME</i>) no rmon alarm <i><1-65535></i>	Configure the RMON alarm group. The no operation of this command deletes the RMON alarm group

6. The configuration and result are displayed

command	explain
Privileged mode&&Global configuration mode	
show rmon statistics (<i>ethernet IFNAME</i>)	The RMON group configuration and statistics result are displayed
show rmon history (<i>ethernet IFNAME</i>)	The RMON historical group configuration and statistics are displayed
show rmon event (<i><1-65535></i>)	Display RMON statistics group configuration
show rmon event-log (<i><1-65535></i>) (<i>event <1-65535></i>)	Displays the logs generated by the RMON statistics group in the alarm group
show rmon alarm	Display RMON alarm group configuration

3.21.3 Rmon for examples

Case 1:

User A has the following requirements: Collects statistics on packets received by 1/0/10 interfaces in real time and generates logs and alarms when the packet rate threshold of the interface is outside the range of 100 to 1000 P/s.

Configuration changes:

- a) Enable RMON
- b) Create RMON statistics table for interface 1/0/10
- c) Create RMON event table
- d) Create the RMON alarm table

The configuration steps are as follows:

```
Switch(config)# snmp-server enable
Switch(config)# rmon statistics 5 Ethernet1/0/10 owner A
Switch(config)# rmon event 1 type log
Switch(config)# rmon event 2 type log
```



```
Switch(config)# rmon alarm 1 1.3.6.1.4.1.6339.100.3.2.1.26.10 interval 5 absolute
rising-threshold 1000 1 falling-threshold 100 2 startup-alarm risingorfalling owner
A
```

Configure the results:

```
Switch(config)# show rmon statistics ethernet 1/0/10
```

```
Statistics entry 5 owner is A.
```

```
Interface : Ethernet1/0/10(index is 10,oid is 1.3.6.1.2.1.2.2.1.1.10)
```

```
0 packets received, 0 octets, 0 packets dorp
```

```
Input packets type statistics:
```

```
broadcast packets :0 ,multicast packets :0
```

```
undersize packets :0 ,oversize packets :0
```

```
fragments packets :0 ,jabbers packets :0
```

```
CRC alignment errors :0 ,collisions :0
```

```
Input packets length statistics:
```

```
(64) packets :0 , (65~127) packets:0
```

```
(128~255) packets :0 , (256~511) packets:0
```

```
(512~1023) packets :0 , (1024~1518)packets:0
```

```
Switch(config)# show rmon event
```

```
History control entry 1 owner is Invalid.
```

```
eventDescription :
```

```
eventType :log
```

```
eventCommunity :
```

```
History control entry 2 owner is Invalid.
```

```
eventDescription :
```

```
eventType :log
```

```
eventCommunity :
```

```
Switch(config)# show rmon alarm
```

```
event index is 1,owner is A
```

```
Interval timer :5
```

```
Variable :1.3.6.1.4.1.6339.100.3.2.1.26.10
```

```
SampleType :absolute
```

```
Startup Alarm :risingorfalling
```

```
Rising Threshold :1000
```

```
Rising EventIndex :1
```

```
Falling Threshold :100
```

```
Falling EventIndex :2
```

```
Switch(config)# show rmon event-log
```

```
logIndex 1 in event 1
```

(24191900)67:11:59.00 The 1.3.6.1.4.1.6339.100.3.2.1.26.10 defined in alarm table 1.alarm sample type is absolute.

log message : alarm rising event : value = 2012, RisingThreshold = 1000

logIndex 2 in event 2

(24204100)67:14:01.00 The 1.3.6.1.4.1.6339.100.3.2.1.26.10 defined in alarm table 1.alarm sample type is absolute.

log message : alarm falling event : value = 45, FallingThreshold = 100

logIndex 1 in event 2

(24133800)67:02:18.00 The 1.3.6.1.4.1.6339.100.3.2.1.26.10 defined in alarm table 1.alarm sample type is absolute.

log message : alarm falling event : value = 0, FallingThreshold = 100

Case 2:

User B has the following requirements: Collects statistics about packets received by 1/0/10 interfaces every interval and generates SNMP trap alarms about packets received by 1/0/10 interfaces whose packet rate threshold is outside the range of 100 to 1000 P/s.

Configuration changes:

- a) Enable RMON
- b) Create a RMON history table for interface 1/0/10
- c) Create RMON event table
- d) Create the RMON alarm table

The configuration steps are as follows:

```
Switch(config)# snmp-server enable
Switch(config)# snmp-server trap-source 110.1.1.2
Switch(config)# snmp-server host 110.1.1.1 v2c 1
Switch(config)# snmp-server enable traps
Switch(config)# rmon history 1 Ethernet1/0/10
Switch(config)# rmon event 1 type trap aa
Switch(config)# rmon event 2 type trap bb
Switch(config)# rmon alarm 1 1.3.6.1.4.1.6339.100.3.2.1.26.10 interval 5 absolute
rising-threshold 1000 1 falling-threshold 100 2 startup-alarm risingorfalling owner
B
```

Configure the results:

```
Switch(config)# show rmon history
History control entry 1 owner is Invalid.
Interface      : Ethernet1/0/10(index is 10,oid is 1.3.6.1.2.1.2.2.1.1.10)
Interval timer : 1800
Buckets numbers : 50
```

History statistics entry index 5 input packets:

```
Start time          : (25189400)69:58:14.00
received packets    : 163757    , received Octets    : 10490273
broadcast packets   : 163695    , multicast packets   : 62
undersize packets   : 0          , oversize packets    : 0
fragments packets   : 0          , jabbers packets     : 0
CRC alignment errors : 0          , collisions          : 0
drop packets        : 0          , utilization          : 0
```

History statistics entry index 4 input packets:

```
Start time          : (25009300)69:28:13.00
received packets    : 163757    , received Octets    : 10490177
broadcast packets   : 163695    , multicast packets   : 62
undersize packets   : 0          , oversize packets    : 0
fragments packets   : 0          , jabbers packets     : 0
CRC alignment errors : 0          , collisions          : 0
drop packets        : 0          , utilization          : 0
```

History statistics entry index 3 input packets:

```
Start time          : (24829300)68:58:13.00
received packets    : 163753    , received Octets    : 10489738
broadcast packets   : 163691    , multicast packets   : 62
undersize packets   : 0          , oversize packets    : 0
fragments packets   : 0          , jabbers packets     : 0
CRC alignment errors : 0          , collisions          : 0
drop packets        : 0          , utilization          : 0
```

History statistics entry index 2 input packets:

```
Start time          : (24649200)68:28:12.00
received packets    : 163758    , received Octets    : 10490241
broadcast packets   : 163696    , multicast packets   : 62
undersize packets   : 0          , oversize packets    : 0
fragments packets   : 0          , jabbers packets     : 0
CRC alignment errors : 0          , collisions          : 0
drop packets        : 0          , utilization          : 0
```

History statistics entry index 1 input packets:

```
Start time          : (24469100)67:58:11.00
received packets    : 163767    , received Octets    : 10491620
broadcast packets   : 163693    , multicast packets   : 74
undersize packets   : 0          , oversize packets    : 0
fragments packets   : 0          , jabbers packets     : 0
CRC alignment errors : 0          , collisions          : 0
drop packets        : 0          , utilization          : 0
```

```
Switch(config)# show rmon event
History control entry 1 owner is Invalid.
  eventDescription :
  eventType :trap
  eventCommunity :aa

History control entry 2 owner is Invalid.
  eventDescription :
  eventType :trap
  eventCommunity :bb
```

```
Switch(config)# show rmon alarm
event index is 1, owner is B
  Interval timer      :5
  Variable            :1.3.6.1.4.1.6339.100.3.2.1.26.10
  SampleType         :absolute
  Startup Alarm       :risingorfalling
  Rising Threshold    :1000
  Rising EventIndex   :1
  Falling Threshold   :100
  Falling EventIndex  :2
```

3.21.4 Rmon Troubleshooting

1. When configuring RMON, ensure that the SNMP-server enable function is enabled by default. No RMON enable deletes all RMON entries.
2. Run the show rmon command to check whether the configuration you sent to the table is correct.
3. Snmp-server enable Traps must be configured before triggering trap alarms.

Chapter 4 IP services Configuration

4.1 Layer 3 Interface

4.1.1 Introduction to Layer 3 Interface

Layer 3 interface can be created on switch. The Layer 3 interface is not a physical interface but a virtual interface. Layer 3 interface is built on VLANs. The Layer 3 interface can contain one or more layer 2 ports which belong to the same VLAN, or contain no layer 2 ports. At least one of the Layer 2 ports contained in Layer 3 interface should be in UP state for Layer 3 interface in UP state, otherwise, Layer 3 interface will be in DOWN state. All layer 3 interfaces in the switch use the same MAC address by default, this address is selected from the reserved MAC address while creating Layer 3 interface. The Layer 3 interface is the base for layer 3 protocols. The switch can use the IP addresses set in the layer 3 interfaces to communicate with the other devices via IP. The switch can forward IP packets between different Layer 3 interfaces. Loopback interface belongs to Layer 3 interface.

4.1.2 Layer 3 Interface Configuration Task List

Layer 3 Interface Configuration Task List:

1. Create Layer 3 interface
2. Bandwidth for Layer 3 Interface configuration
3. Configure VLAN interface description
4. Open or close the VLAN interface
5. VRF configuration
 - (1) Create VRF instance and enter VPN view
 - (2) Configure RD of VRF instance (optional)
 - (3) Configure RT of VRF instance (optional)
 - (4) Configure the relation between VRF instance and the interface

1. Create Layer 3 Interface

Command	Explanation
Global Mode	
interface vlan <vlan-id> no interface vlan <vlan-id>	Creates a VLAN interface (VLAN interface is a Layer 3 interface); the no command deletes the VLAN interface (Layer 3 interface) created in the switch.
interface loopback <loopback-id> no interface loopback <loopback-id>	Creates a Loopback interface then enter the loopback Port Mode; the no command deletes the Loopback interface created in the switch.

2. Bandwidth for Layer 3 Interface configuration

Command	Explanation
VLAN Interface Mode	
bandwidth <bandwidth> no bandwidth	Configure the bandwidth for Layer 3 Interface. The no command recovery the default value.

3. Configure VLAN interface description

Command	Explanation
VLAN Interface Mode	
description <text> no description	Configure the description information of VLAN interface. The no command will cancel the description information of VLAN interface.

4. Open or close the vlan interface

Command	Explanation
VLAN Interface Mode	
shutdown no shutdown	Open or close the vlan interface.

5. VRF configuration

- (1) Create VRF instance and enter VPN view
- (2) Configure RD of VRF instance (optional)
- (3) Configure RT of VRF instance (optional)
- (4) Configure the relation between VRF instance and the interface

Command	Explanation
Global Mode	
ip vrf <vrf-name> no ip vrf <vrf-name>	Create VRF instance; VRF instance is not created by default.
VRF Mode	
rd <ASN:nn_or_IP-address:nn>	Configure RD of VRF instance. RD is not created by default.
route-target {import export both} <rt-value> no route-target {import export both} <rt-value>	Configure RT of VRF instance
Interface Mode	
ip vrf forwarding <vrf-name> no ip vrf forwarding <vrf-name>	Configure the relation between VRF instance and the interface.
ip address <ip-address> <mask> no ip address <ip-address> <mask>	Configure the private IP address of direct link interface.

4.2 Network Management Port

4.2.1 Introduce to IP Network Management Port

The Network Management Port is located above the Console interface on the master management cards, marked as “Ethernet”, the software configuration name for this port is “Ethernet0”. The user can use the command “interface Ethernet 0” to access the network port configuration mode. The user can use programs such as Telnet, Web management and FTP to manage the switch through an Ethernet cable connected to the network management port.

4.2.2 Network Management Port Configuration

Network Management Port Configuration Task List:

1. Enter the network management port configuration mode
2. Configure the properties for the network management ports
 - (1) Enable/Disable ports
 - (2) Configuring port IP Address

1. Enter the network management port configuration mode

Command	Explanation
Global Mode	
interface ethernet <num>	Enters the network management port configuration mode.

2. Configure the properties for the network management port

Command	Explanation
Network Management Port Configuration	
shutdown no shutdown	Enables/Disables network management port.
ip address <ip-address> <mask> no ip address [<ip-address> <mask>]	Configures or cancels the IP address for network management port.

4.3 IP Configuration

4.3.1 Introduction to IPv4, IPv6

IPv4 is the current version of global universal Internet protocol. The practice has proved that IPv4 is simple, flexible, open, stable, strong and easy to implement while collaborating well with

various protocols of upper and lower layers. Although IPv4 almost has not been changed since it was established in 1980's, it has kept growing to the current global scale with the promotion of Internet. However, as Internet infrastructure and Internet application services continue boosting, IPv4 has shown its deficiency when facing the present scale and complexity of Internet.

IPv6 refers to the sixth version of Internet protocol which is the next generation Internet protocol designed by IETF to replace the current Internet protocol version 4 (IPv4). IPv6 was specially developed to make up the shortages of IPv4 addresses so that Internet can develop further.

The most important problem IPv6 has solved is to add the amount of IP addresses. IPv4 addresses have nearly run out, whereas the amount of Internet users has been increasing in geometric series. With the greatly and continuously boosting of Internet services and application devices (Home and Small Office Network, IP phone and Wireless Service Information Terminal which make use of Internet,) which require IP addresses, the supply of IP addresses turns out to be more and more tense. People have been working on the problem of shortage of IPv4 addresses for a long time by introducing various technologies to prolong the lifespan of existing IPv4 infrastructure, including Network Address Translation(NAT for short), and Classless Inter-Domain Routing(CIDR for short), etc.

Although the combination of CIDR, NAT and private addressing has temporarily mitigated the problem of IPv4 address space shortage, NAT technology has disrupted the end-to-end model which is the original intention of IP design by making it necessary for router devices that serve as network intermediate nodes to maintain every connection status which increases network delay greatly and decreases network performance. Moreover, the translation of network data packet addresses baffles the end-to-end network security check, IPSec authentication header is such an example.

Therefore, in order to solve all kinds of problems existing in IPv4 comprehensively, the next generation Internet Protocol IPv6 designed by IETF has become the only feasible solution at present.

First of all, the 128 bits addressing scheme of IPv6 Protocol can guarantee to provide enough globally unique IP addresses for global IP network nodes in the range of time and space. Moreover, besides increasing address space, IPv6 also enhanced many other essential designs of IPv4.

Hierarchical addressing scheme facilitates Route Aggregation, effectively reduces route table entries and enhances the efficiency and expansibility of routing and data packet processing.

The header design of IPv6 is more efficient compared with IPv4. It has less data fields and takes out header checksum, thus expedites the processing speed of basic IPv6 header. In IPv6 header, fragment field can be shown as an optional extended field, so that data packets fragmentation process won't be done in router forwarding process, and Path MTU Discovery Mechanism collaborates with data packet source which enhances the processing efficiency of router.

Address automatic configuration and plug-and-play is supported. Large amounts of hosts can find network routers easily by address automatic configuration function of IPv6 while obtaining a globally unique IPv6 address automatically as well which makes the devices using IPv6 Internet plug-and-play. Automatic address configuration function also makes the readdressing of existing network easier and more convenient, and it is more convenient for network operators to manage the transformation from one provider to another.

Support IPSec. IPSec is optional in IPv4, but required in IPv6 Protocol. IPv6 provides security extended header, which provides end-to-end security services such as access control, confidentiality and data integrity, consequently making the implement of encryption, validation and Virtual Private Network easier.

Enhance the support for Mobile IP and mobile calculating devices. The Mobile IP Protocol defined in IETF standard makes mobile devices movable without cutting the existing connection, which is a network function getting more and more important. Unlike IPv4, the mobility of IPv6 is from embedded automatic configuration to get transmission address (Care-Of-Address); therefore it doesn't need Foreign Agent. Furthermore, this kind of binding process enables Correspondent Node communicate with Mobile Node directly, thereby avoids the extra system cost caused by triangle routing choice required in IPv4.

Avoid the use of Network Address Translation. The purpose of the introduction of NAT mechanism is to share and reuse same address space among different network segments. This mechanism mitigates the problem of the shortage of IPv4 address temporarily; meanwhile it adds the burden of address translation process for network device and application. Since the address space of IPv6 has increased greatly, address translation becomes unnecessary, thus the problems and system cost caused by NAT deployment are solved naturally.

Support extensively deployed Routing Protocol. IPv6 has kept and extended the supports for existing Internal Gateway Protocols (IGP for short), and Exterior Gateway Protocols (EGP for short). For example, IPv6 Routing Protocol such as RIPng, OSPFv3, IS-ISv6 and MBGP4+, etc.

Multicast addresses increased and the support for multicast has enhanced. By dealing with IPv4 broadcast functions such as Router Discovery and Router Query, IPv6 multicast has completely replaced IPv4 broadcast in the sense of function. Multicast not only saves network bandwidth, but enhances network efficiency as well.

4.3.2 IP Configuration

Layer 3 interface can be configured as IPv4 interface, IPv6 interface.

4.3.2.1 IPv4 Address Configuration

IPv4 address configuration task list:

1. Configure the IPv4 address of three-layer interface

1. Configure the IPv4 address of three-layer interface

Command	Explanation
VLAN Interface Configuration Mode	
ip address <ip-address> <mask> [secondary] no ip address [<ip-address> <mask>]	Configure IP address of VLAN interface; the no ip address [<ip-address> <mask>] command cancels IP address of VLAN interface.

4.3.2.2 IPv6 Address Configuration

The configuration Task List of IPv6 is as follows:

1. IPv6 basic configuration
 - (1) Configure interface IPv6 address
 - (2) Configure IPv6 static routing
2. IPv6 Neighbor Discovery Configuration
 - (1) Configure DAD neighbor solicitation message number
 - (2) Configure send neighbor solicitation message interval
 - (3) Enable and disable router advertisement
 - (4) Configure router lifespan
 - (5) Configure router advertisement minimum interval
 - (6) Configure router advertisement maximum interval
 - (7) Configure prefix advertisement parameters
 - (8) Configure static IPv6 neighbor entries
 - (9) Delete all entries in IPv6 neighbor table
 - (10) Set the hoplimit of sending router advertisement
 - (11) Set the mtu of sending router advertisement
 - (12) Set the reachable-time of sending router advertisement
 - (13) Set the retrans-timer of sending router advertisement
 - (14) Set the flag representing whether information other than the address information will be obtained via DHCPv6
 - (15) Set the flag representing whether the address information will be obtained via DHCPv6
3. IPv6 Tunnel configuration
 - (1) Create/Delete Tunnel
 - (2) Configure tunnel description
 - (3) Configure Tunnel Source
 - (4) Configure Tunnel Destination
 - (5) Configure Tunnel Next-Hop
 - (6) Configure Tunnel Mode
 - (7) Configure Tunnel Routing

1. IPv6 Basic Configuration

- (1) Configure interface IPv6 address

Command	Explanation
Interface Configuration Mode	
ipv6 address <i><ipv6-address/prefix-length></i> [eui-64] no ipv6 address <i><ipv6-address/prefix-length></i>	Configure IPv6 address, including aggregatable global unicast addresses, site-local addresses and link-local addresses. The no ipv6 address <ipv6-address/prefix-length> command cancels IPv6 address.

- (2) Set IPv6 Static Routing

Command	Explanation

Global mode	
<pre> ipv6 route <ipv6-prefix/prefix-length> {<nexthop-ipv6-address> <interface- type interface-number> {<nexthop-ipv6-address> <interface-type interface-number>}} [distance] no ipv6 route <ipv6-prefix/prefix-length> {<nexthop-ipv6-address> <interface- type interface-number> {<nexthop-ipv6-address> <interface-type interface-number>}} [distance] </pre>	Configure IPv6 static routing. The no command cancels IPv6 static routing.

2. IPv6 Neighbor Discovery Configuration

(1) Configure DAD Neighbor solicitation Message number

Command	Explanation
Interface Configuration Mode	
<pre> ipv6 nd dad attempts <value> no ipv6 nd dad attempts </pre>	Set the neighbor query message number sent in sequence when the interface makes duplicate address detection. The no command resumes default value (1).

(2) Configure Send Neighbor solicitation Message Interval

Command	Explanation
Interface Configuration Mode	
<pre> ipv6 nd ns-interval <seconds> no ipv6 nd ns-interval </pre>	Set the interval of the interface to send neighbor query message. The NO command resumes default value (1 second).

(3) Enable and disable router advertisement

Command	Explanation
Interface Configuration Mode	
<pre> ipv6 nd suppress-ra no ipv6 nd suppress-ra </pre>	Forbid IPv6 Router Advertisement. The NO command enables IPv6 router advertisement.

(4) Configure Router Lifespan

Command	Explanation
Interface Configuration Mode	
<pre> ipv6 nd ra-lifetime <seconds> no ipv6 nd ra-lifetime </pre>	Configure Router advertisement Lifespan. The NO command resumes default value (1800 seconds).

(5) Configure router advertisement Minimum Interval

Command	Description
Interface Configuration Mode	
ipv6 nd min-ra-interval <seconds> no ipv6 nd min-ra-interval	Configure the minimum interval for router advertisement. The NO command resumes default value (200 seconds).

(6) Configure router advertisement Maximum Interval

Command	Explanation
Interface Configuration Mode	
ipv6 nd max-ra-interval <seconds> no ipv6 nd max-ra-interval	Configure the maximum interval for router advertisement. The NO command resumes default value (600 seconds).

(7) Configure prefix advertisement parameters

Command	Explanation
Interface Configuration Mode	
ipv6 nd prefix <i><ipv6-address/prefix-length></i> <i><valid-lifetime> <preferred-lifetime></i> [off-link] [no-autoconfig] no ipv6 nd prefix <i><ipv6-address/prefix-length></i> <i><valid-lifetime> <preferred-lifetime></i> [off-link] [no-autoconfig]	Configure the address prefix and advertisement parameters of router. The NO command cancels the address prefix of routing advertisement.

(8) Configure static IPv6 neighbor Entries

Command	Explanation
Interface Configuration Mode	
ipv6 neighbor <ipv6-address> <i><hardware-address></i> interface <i><interface-type interface-name></i>	Set static neighbor table entries, including neighbor IPv6 address, MAC address and two-layer port.
no ipv6 neighbor <ipv6-address>	Delete neighbor table entries.

(9) Delete all entries in IPv6 neighbor table

Command	Explanation
Admin Mode	
clear ipv6 neighbors	Clear all static neighbor table entries.

(10) Set the hoplimit of sending router advertisement

Command	Explanation
Interface Configuration Mode	
ipv6 nd ra-hoplimit <value>	Set the hoplimit of sending router advertisement.

(11) Set the mtu of sending router advertisement

Command	Explanation
Interface Configuration Mode	
ipv6 nd ra-mtu <value>	Set the mtu of sending router advertisement.

(12) Set the reachable-time of sending router advertisement

Command	Explanation
Interface Configuration Mode	
ipv6 nd reachable-time <seconds>	Set the reachable-time of sending router advertisement.

(13) Set the retrans-timer of sending router advertisement

Command	Explanation
Interface Configuration Mode	
ipv6 nd retrans-timer <seconds>	Set the retrans-timer of sending router advertisement.

(14) Set the flag representing whether information other than the address information will be obtained via DHCPv6.

Command	Explanation
Interface Configuration Mode	
ipv6 nd other-config-flag	Set the flag representing whether information other than the address information will be obtained via DHCPv6.

(15) Set the flag representing whether the address information will be obtained via DHCPv6

Command	Explanation
Interface Configuration Mode	
ipv6 nd managed-config-flag	Set the flag representing whether the address information will be obtained via DHCPv6.

3. IPv6 Tunnel Configuration

(1) Add/Delete tunnel

Command	Explanation
Global mode	
interface tunnel <tnl-id> no interface tunnel <tnl-id>	Create a tunnel. The NO command deletes a tunnel.

(2) Configure tunnel description

Command	Explanation
Tunnel Configuration Mode	
description <desc>	Configure tunnel description. The NO command

no description	deletes the tunnel description.
-----------------------	---------------------------------

(3) Configure tunnel source

Command	Explanation
Tunnel Configuration Mode	
tunnel source { <ipv4-address> <ipv6-address> <interface-name> } no tunnel source	Configure tunnel source end IPv4/IPv6 address. The NO command deletes the IPv4/IPv6 address of tunnel source end.

(4) Configure Tunnel Destination

Command	Explanation
Tunnel Configuration Mode	
tunnel destination {<ipv4-address> <ipv6-address>} no tunnel destination	Configure tunnel destination end IPv4/IPv6 address. The NO command deletes the IPv4/IPv6 address of tunnel destination end.

(5) Configure Tunnel Next-Hop

Command	Explanation
Tunnel Configuration Mode	
tunnel nexthop <ipv4-address> no tunnel nexthop	Configure tunnel next-hop IPv4 address. The NO command deletes the IPv4 address of tunnel next-hop end.

(6) Configure Tunnel Mode

Command	Explanation
Tunnel Configuration Mode	
tunnel mode [[gre] ipv6ip [6to4 isatap]] no tunnel mode	Configure tunnel mode. The NO command clears tunnel mode.

(7) Configure Tunnel Routing

Command	Explanation
Global mode	
ipv6 route <ipv6-address/prefix-length> {<interface-type interface-number> tunnel <tnl-id>} no ipv6 route <ipv6-address/prefix-length> {<interface-type interface-number> tunnel <tnl-id>}	Configure tunnel routing. The NO command clears tunnel routing.

4.3.3 IP Configuration Examples

4.3.3.1 Configuration Examples of IPv4

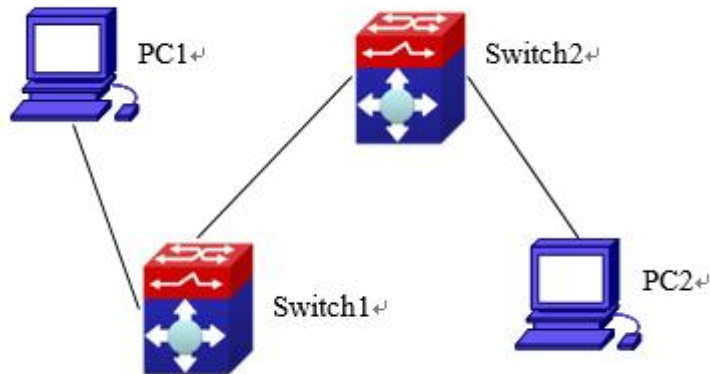

Figure 3- 1 IPv4 configuration example

The user's configuration requirements are: Configure IP address of different network segments on Switch1 and Switch2, configure static routing and validate accessibility using ping function.

Configuration Description:

1. Configure two VLANs on Switch1, namely, VLAN1 and VLAN2.
2. Configure IPv4 address 192.168.1.1 255.255.255.0 in VLAN1 of Switch1, and configure IPv4 address 192.168.2.1 255.255.255.0 in VLAN2.
3. Configure two VLANs on Switch2, respectively VLAN2 and VLAN3.
4. Configure IPv4 address 192.168.2.2 255.255.255.0 in VLAN2 of Switch2, and configure IPv4 address 192.168.3.1 255.255.255.0 in VLAN3.
5. The IPv4 address of PC1 is 192.168.1.100 255.255.255.0, and the IPv4 address of PC2 is 192.168.3.100 255.255.255.0.
6. Configure static routing 192.168.3.0/24 on Switch1, and configure static routing 192.168.1.0/24 on Switch2.
7. Ping each other among PCs.

Note: First make sure PC1 and Switch1 can access each other by ping, and PC2 and Switch2 can access each other by ping.

The configuration procedure is as follows:

```
Switch1(config)#interface vlan 1
Switch1(Config-if-Vlan1)#ip address 192.168.1.1 255.255.255.0
Switch1(config)#interface vlan 2
Switch1(Config-if-Vlan2)#ip address 192.168.2.1 255.255.255.0
Switch1(Config-if-Vlan2)#exit
Switch1(config)#ip route 192.168.3.0 255.255.255.0 192.168.2.2
```

```
Switch2(config)#interface vlan 2
Switch2(Config-if-Vlan2)#ip address 192.168.2.2 255.255.255.0
```

```
Switch2(config)#interface vlan 3
Switch2(Config-if-Vlan3)#ip address 192.168.3.1 255.255.255.0
Switch2(Config-if-Vlan3)#exit
Switch2(config)#ip route 192.168.1.0 255.255.255.0 192.168.2.1
```

4.3.3.2 Configuration Examples of IPv6

Example 1:

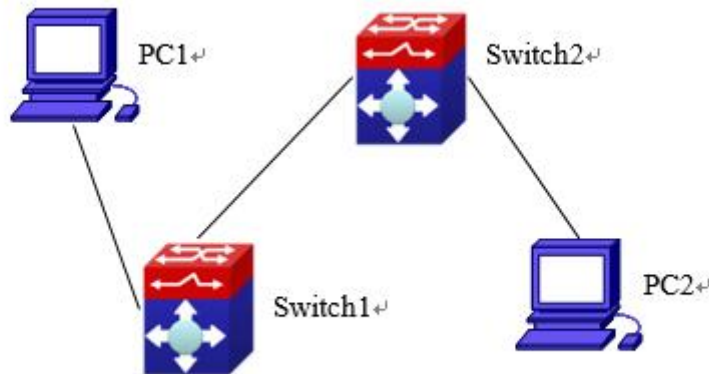

Figure 3-2 IPv6 configuration example

The user's configuration requirements are: Configure IPv6 address of different network segments on Switch1 and Switch2, configure static routing and validate reachability using ping6 function.

Configuration Description:

1. Configure two VLANs on Switch1, namely, VLAN1 and VLAN2.
2. Configure IPv6 address 2001::1/64 in VLAN1 of Switch1, and configure IPv6 address 2002::1/64 in VLAN2.
3. Configure 2 VLANs on Switch2, namely, VLAN2 and VLAN3.
4. Configure IPv6 address 2002::2/64 in VLAN2 of Switch2, and configure IPv6 address 2003::1/64 in VLAN3.
5. The IPv6 address of PC1 is 2001::11/64, and the IPv6 address of PC2 is 2003::33/64.
6. Configure static routing 2003::33/64 on Switch1, and configure static routing 2001::11/64 on Switch2.
7. ping6 each other among PCs.

Note: First make sure PC1 and Switch1 can access each other by ping, and PC2 and Switch2 can access each other by ping.

The configuration procedure is as follows:

```
Switch1(Config)#interface vlan 1
Switch1(Config-if-Vlan1)#ipv6 address 2001::1/64
Switch1(Config)#interface vlan 2
Switch1(Config-if-Vlan2)#ipv6 address 2002::1/64
```



```
Switch1(Config-if-Vlan2)#exit
Switch1(Config)#ipv6 route 2003::33/64 2002::2

Switch2(Config)#interface vlan 2
Switch2(Config-if-Vlan2)#ipv6 address 2002::2/64
Switch2(Config)#interface vlan 3
Switch2(Config-if-Vlan3)#ipv6 address 2003::1/64
Switch2(Config-if-Vlan3)#exit
Switch2(Config)#ipv6 route 2001::33/64 2002::1
```

```
Switch1#ping6 2003::33
```

Configuration result:

```
Switch1#show run
interface Vlan1
  ipv6 address 2001::1/64
  !
interface Vlan2
  ipv6 address 2002::2/64
  !
interface Loopback
  mtu 3924
  !
ipv6 route 2003::/64 2002::2
  !
no login
  !
end
```

```
Switch2#show run
interface Vlan2
  ipv6 address 2002::2/64
  !
interface Vlan3
  ipv6 address 2003::1/64
  !
interface Loopback
  mtu 3924
  !
ipv6 route 2001::/64 2002::1
  !
no login
  !
End
```

Example 2:

Figure 3-3 IPv6 tunnel

This case is IPv6 tunnel with the following user configuration requirements: SwitchA and SwitchB are tunnel nodes, dual-stack is supported. SwitchC only runs IPv4, PC-A and PC-B communicate.

Configuration Description:

1. Configure two vlans on SwitchA, namely, VLAN1 and VLAN2. VLAN1 is IPv6 domain, VLAN2 connects to IPv4 domain.
2. Configure IPv6 address 2002:caca:ca01:2::1/64 in VLAN1 of SwitchA and turn on RA function, configure IPv4 address 202.202.202.1 in VLAN2.
3. Configure two VLANs on SwitchB, namely, VLAN3 and VLAN4, VLAN4 is IPv6 domain, and VLAN3 connects to IPv4 domain.
4. Configure IPv6 address 2002:cacb:cb01:2::1/64 in VLAN4 of SwitchB and turn on RA function, configure IPv4 address 203.203.203.1 on VLAN3.
5. Configure tunnel on SwitchA, the source IPv4 address of the tunnel is 202.202.202.1, the tunnel routing is ::/0
6. Configure tunnel on SwitchB, the source IPv4 address of the tunnel is 203.203.203.1, and the tunnel routing is ::/0
7. Configure two VLANs on SwitchC, namely, VLAN2 and VLAN3. Configure IPv4 address 202.202.202.202 on VLAN2 and configure IPv4 address 203.203.203.203 on VLAN3.
8. PC-A and PC-B get the prefix of 2002 via SwitchA and SwitchB to configure IPv6

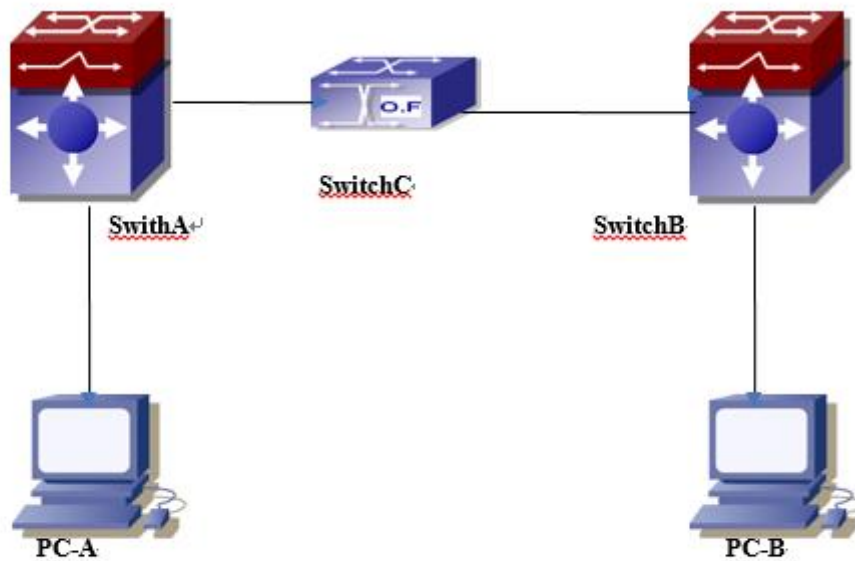
address automatically.

9. On PC-A, ping IPv6 address of PC-B

The configuration procedure is as follows:

```
SwitchA(Config-if-Vlan1)#ipv6 address 2002:caca:ca01:2::1/64
```

```
SwitchA(Config-if-Vlan1)#no ipv6 nd suppress-ra
```

```
SwitchA(Config-if-Vlan1)#interface vlan 2
```

```
SwitchA(Config-if-Vlan2)#ipv4 address 202.202.202.1 255.255.255.0
```

```
SwitchA(Config-if-Vlan1)#exit
```

```
SwitchA(config)# interface tunnel 1
```

```
SwitchA(Config-if-Tunnel1)#tunnel source 202.202.202.1
```

```
SwitchA(Config-if-Tunnel1)#tunnel destination 203.203.203.1
```

```
SwitchA(Config-if-Tunnel1)#tunnel mode ipv6ip
```

```
SwitchA(config)#ipv6 route ::/0 tunnel1
```

```
SwitchB(Config-if-Vlan4)#ipv6 address 2002:cacb:cb01::2/64
```

```
SwitchB(Config-if-Vlan4)#no ipv6 nd suppress-ra
```

```
SwitchB (Config-if-Vlan3)#interface vlan 3
```

```
SwitchB (Config-if-Vlan2)#ipv4 address 203.203.203.1 255.255.255.0
```

```
SwitchB (Config-if-Vlan1)#exit
```

```
SwitchB(config)#interface tunnel 1
```

```
SwitchB(Config-if-Tunnel1)#tunnel source 203.203.203.1
```

```
SwitchB(Config-if-Tunnel1)#tunnel destination 202.202.202.1
```

```
SwitchB(Config-if-Tunnel1)#tunnel mode ipv6ip
```

```
SwitchB(config)#ipv6 route ::/0 tunnel1
```

4.3.4 IPv6 Troubleshooting

☞ The router lifespan configured should not be smaller than the Send Router advertisement Interval. If the connected PC has not obtained IPv6 address, you should check RA announcement switch (the default is turned off).

4.4 IP Forwarding

4.4.1 Introduction to IP Forwarding

Gateway devices can forward IP packets from one subnet to another; such forwarding uses routes to find a path. IP forwarding of switch is done with the participation of hardware, and can achieve wire speed forwarding. In addition, flexible management is provided to adjust and monitor forwarding. Switch supports aggregation algorithm enabling/disabling optimization to adjust generation of network route entry in the switch chip and view statistics for IP forwarding

and hardware forwarding chip status.

4.4.2 IP Route Aggregation Configuration Task

IP route aggregation configuration task:

1. Set whether IP route aggregation algorithm with/without optimization should be used

1. Set whether IP route aggregation algorithm with/without optimization should be used

Command	Explanation
Global Mode	
ip fib optimize no ip fib optimize	Enables the switch to use optimized IP route aggregation algorithm; the “ no ip fib optimize ” disables the optimized IP route aggregation algorithm.

4.5 URPF

4.5.1 Introduction to URPF

URPF (Unicast Reverse Path Forwarding) introduces the RPF technology applied in multicast to unicast, so to protect the network from the attacks which is based on source address cheat.

When switch receives the packet, it will search the route in the route table using the source address as the destination address which is acquired from the packet. If the found router exit interface does not match the entrance interface acquired from this packet, the switch will consider this packet a fake packet and discard it.

In Source Address Spoofing attacks, attackers will construct a series of messages with fake source addresses. For applications based on IP address verification, such attacks may allow unauthorized users to access the system as some authorized ones, or even the administrator. Even if the response messages can't reach the attackers, they will also damage the targets.

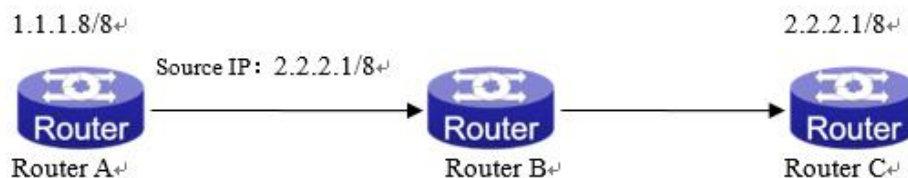

Figure 3-4 URPF application situation

In the above figure, Router A sends requests to the server Router B by faking messages whose source address are 2.2.2.1/8. In response, Router B will send the messages to the real “2.2.2.1/8”. Such illegal messages attack both Router B and Router C. The application of URPF technology in the situation described above can avoid the attacks based on the Source Address

ethernet IFNAME	the port
show urpf rule ipv6 num interface ethernet IFNAME	Display the number of IPv6 rules bound to the port.
show urpf rule ipv4 interface ethernet IFNAME	Display the details of IPv4 rules bound to the port.
show urpf rule ipv6 interface ethernet IFNAME	Display the details of IPv6 rules bound to the port.

4.5.3 URPF Typical Example

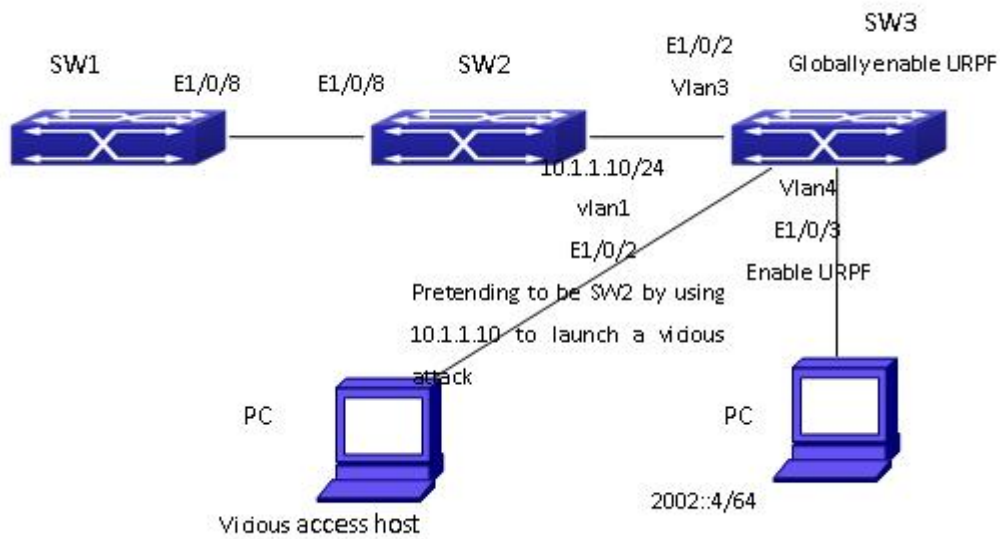

Figure 3-5 URPF Typical Example

In the network, topology shown in the graph above, IP URPF function is enabled on SW3. When there is someone in the network pretending to be someone else by using his IP address to launch a vicious attack, the switch will drop all the attacking messages directly through the hardware function.

Enable the URPF function in SW3.

SW3 configuration task sequence:

```
Switch3#config
```

```
Switch3(config)#urpf enable
```

4.5.4 URPF Troubleshooting

If all configurations are normal but URPF still can't operate as expected, please enable the URPF debug function and use 'show urpf' command to observe whether URPF is enabled, and send the result to the technology service center.



4.6 ARP

4.6.1 Introduction to ARP

ARP (Address Resolution Protocol) is mainly used to resolve IP address to Ethernet MAC address. Switch supports both dynamic ARP and static ARP configuration. Furthermore, switch supports the configuration of proxy ARP for some applications. For instance, when an ARP request is received on the port, requesting an IP address in the same IP segment of the port but not the same physical network, if the port has enabled proxy ARP, the port would reply to the ARP with its own MAC address and forward the actual packets received. Enabling proxy ARP allows machines physically separated but of the same IP segment ignores the physical separation and communicate via proxy ARP interface as if in the same physical network.

4.6.2 ARP Configuration Task List

ARP Configuration Task List:

1. Configure static ARP
2. Configure proxy ARP
3. Clear dynamic ARP
4. Clear the statistic information of ARP messages

1. Configure static ARP

Command	Explanation
VLAN Interface Mode	
arp <ip_address> <mac_address> {interface [ethernet] <portName>} no arp <ip_address>	Configures a static ARP entry; the no command deletes a ARP entry of the specified IP address.

2. Configure proxy ARP

Command	Explanation
VLAN Interface Mode	
ip proxy-arp no ip proxy-arp	Enables the proxy ARP function for Ethernet ports: the no command disables the proxy ARP.

3. Clear dynamic ARP

Command	Explanation
Admin mode	
clear arp-cache	Clear the dynamic ARP learnt by the switch.

4. Clear the statistic information of ARP message

Command	Explanation
Admin mode	
clear arp traffic	Clear the statistic information of ARP messages of the switch.

4.6.3 ARP Troubleshooting

If ping from the switch to directly connected network devices fails, the following can be used to check the possible cause and create a solution.

- ☞ Check whether the corresponding ARP has been learned by the switch.
- ☞ If ARP has not been learned, then enabled ARP debugging information and view the sending/receiving condition of ARP packets.
- ☞ Defective cable is a common cause of ARP problems and may disable ARP learning.

4.7 ARP Scanning Prevention

4.7.1 Introduction to ARP Scanning Prevention

Function

ARP scanning is a common method of network attack. In order to detect all the active hosts in a network segment, the attack source will broadcast lots of ARP messages in the segment, which will take up a large part of the bandwidth of the network. It might even do large-traffic-attack in the network via fake ARP messages to collapse of the network by exhausting the bandwidth. Usually ARP scanning is just a preface of other more dangerous attack methods, such as automatic virus infection or the ensuing port scanning, vulnerability scanning aiming at stealing information, distorted message attack, and DOS attack, etc.

Since ARP scanning threatens the security and stability of the network with great danger, so it is very significant to prevent it. Switch provides a complete resolution to prevent ARP scanning: if there is any host or port with ARP scanning features is found in the segment, the switch will cut off the attack source to ensure the security of the network.

There are two methods to prevent ARP scanning: port-based and IP-based. The port-based ARP scanning will count the number to ARP messages received from a port in a certain time range, if the number is larger than a preset threshold, this port will be “down”. The IP-based ARP scanning rate-limiting and isolate two levels threshold, when it above level-1 threshold (the limited threshold), the hardware transmits the ARP packet (including ARP request and reply) of this host normally, and only limit the CPU rate. And produce trap warning to notify administrator

that there may be attacked; when packets rate is level-2 threshold (isolation threshold), it will take action, record log and produce trap warning. The level-1 limited threshold and level-2 isolate threshold will be open when enable IP-based ARP scanning in global mode, level-1 threshold will take effect until it lower than level-2 threshold. The two kind of ARP scanning prevention can be start using at the same time, after port is banned, it can recover the state by configure the function of automatic recovery. After IP is banned, it can be automatic recovery when the rate of received arp packets is lower than level-2 threshold.

To improve the effect of the switch, users can configure trusted ports and IP, the ARP messages from which will not be checked by the switch. Thus the load of the switch can be effectively decreased.

4.7.2 ARP Scanning Prevention Configuration Task

Sequence

1. Enable the ARP Scanning Prevention function.
2. Configure the threshold of the port-based and IP-based ARP Scanning Prevention
3. Configure trusted ports
4. Configure trusted IP
5. Configure automatic recovery time
6. Display relative information of debug information and ARP scanning
7. Configure the action after above level-2 threshold.

1. Enable the ARP Scanning Prevention function.

Command	Explanation
Global configuration mode	
anti-arpscan enable [ip port] no anti-arpscan enable [ip port]	Enable or disable the ARP Scanning Prevention function globally.

2. Configure the threshold of the port-based and IP-based ARP Scanning Prevention

Command	Explanation
Global configuration mode	
anti-arpscan port-based threshold <threshold-value> no anti-arpscan port-based threshold	Set the threshold of the port-based ARP Scanning Prevention.
anti-arpscan ip-based {level1 level2} threshold <threshold-value> no anti-arpscan ip-based {level1 level2} threshold	Set the threshold of the IP-based ARP Scanning Prevention.

3. Configure trusted ports

Command	Explanation
---------	-------------

Port configuration mode	
anti-arpscan trust {port supertrust-port iptrust-port} no anti-arpscan trust {port supertrust-port iptrust-port}	Set the trust attributes of the ports.

4. Configure trusted IP

Command	Explanation
Global configuration mode	
anti-arpscan trust ip <ip-address> [<netmask>] no anti-arpscan trust ip <ip-address> [<netmask>]	Set the trust attributes of IP.

5. Configure automatic recovery time

Command	Explanation
Global configuration mode	
anti-arpscan recovery enable no anti-arpscan recovery enable	Enable or disable the automatic recovery function.
anti-arpscan recovery time <seconds> no anti-arpscan recovery time	Set automatic recovery time.

6. Display relative information of debug information and ARP scanning

anti-arpscan log enable no anti-arpscan log enable	Enable or disable the log function of ARP scanning prevention.
anti-arpscan trap enable [level1 level2] no anti-arpscan trap enable [level1 level2]	Enable or disable the SNMP Trap function of ARP scanning prevention.
anti-arpscan FFP max-num <num>	The maximum quantity of ARP scanning prevention function occupied FFP item.
show anti-arpscan [trust {ip port supertrust-port iptrust-port} prohibited {ip port}]	Display the state of operation and configuration of ARP scanning prevention.
show anti-arpscan ip-based attack-list [history]	Display source information or history source information of ARP scanning attacks prevention.
show anti-arpscan ip-based running-config	Display the current configuration of arp scanning prevention.
clear anti-arpscan speed-limit< IP Address>	Flush ARP limited rate for specified host manually.
clear anti-arpscan ip-isolate<IP Address>	Flush IP business isolation for specified host manually.
clear anti-arpscan attack-list {ip < IP Address > all }	Clear the ARP limit of the specific host or all the hosts manually.

clear anti-arpscan attack-history-list {ip < IP Address > all }	Clear the history attacks source information of ARP scanning prevention manually.
Admin Mode	
debug anti-arpscan [port ip] no debug anti-arpscan [port ip]	Enable or disable the debug switch of ARP scanning prevention.

7. Configure the action after above level-2 threshold

Command	Explanation
Global configuration Mode	
anti-arpscan ip-based level2 action {isolate discard-ARP}	After above level-2 threshold, users can configure ip business isolation and discard ARP packets.
anti-arpscan ip-based arp-to-cpu speed <pps> no anti-arpscan ip-based arp-to-cpu speed	Configure the rate of ARP send to CPU when level-1 threshold overrun.

4.7.3 ARP Scanning Prevention Typical Examples

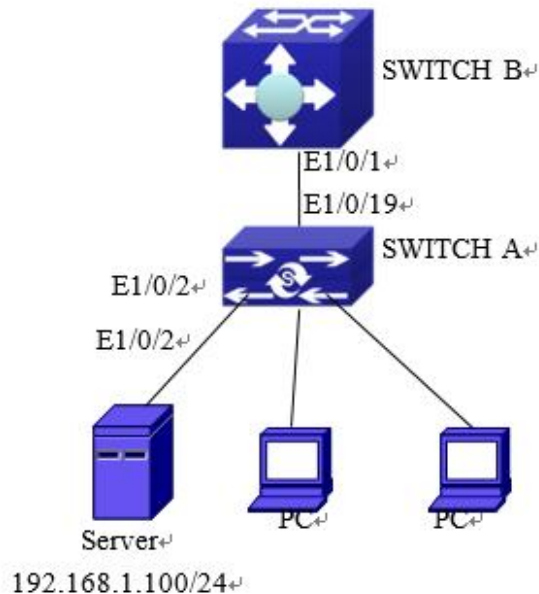

Figure 3-6 ARP scanning prevention typical configuration example

In the network topology above, port E1/0/1 of SWITCH B is connected to port E1/0/19 of SWITCH A, the port E1/0/2 of SWITCH A is connected to file server (IP address is 192.168.1.100/24), and all the other ports of SWITCH A are connected to common PC. The following configuration can prevent ARP scanning effectively without affecting the normal operation of the system.

SWITCH A configuration task sequence:

```
SwitchA(config)#anti-arpscan enable
```

```
SwitchA(config)#anti-arp scan recovery time 3600
SwitchA(config)#anti-arp scan trust ip 192.168.1.100 255.255.255.0
SwitchA(config)#interface ethernet1/0/2
SwitchA (Config-If-Ethernet1/0/2)#anti-arp scan trust port
SwitchA (Config-If-Ethernet1/0/2)#exit
SwitchA(config)#interface ethernet1/0/19
SwitchA (Config-If-Ethernet1/0/19)#anti-arp scan trust supertrust-port
Switch A(Config-If-Ethernet1/0/19)#exit
```

SWITCHB configuration task sequence:

```
Switch B(config)# anti-arp scan enable
SwitchB(config)#interface ethernet1/0/1
SwitchB(Config-If-Ethernet1/0/1)#anti-arp scan trust port
SwitchB(Config-If-Ethernet1/0/1)exit
```

4.7.4 ARP Scanning Prevention Troubleshooting Help

- 👉 ARP scanning prevention is disabled by default. After enabling ARP scanning prevention, users can enable the debug switch, “**debug anti-arp scan**”, to view debug information.

4.8 Prevent ARP Spoofing

4.8.1 Overview

4.8.1.1 ARP (Address Resolution Protocol)

Generally speaking, ARP (RFC-826) protocol is mainly responsible of mapping IP address to relevant 48-bit physical address, that is MAC address, for instance, IP address is 192.168.0.1, network card Mac address is 00-03-0F-FD-1D-2B. What the whole mapping process is that a host computer send broadcast data packet involving IP address information of destination host computer, ARP request, and then the destination host computer send a data packet involving its IP address and Mac address to the host, so two host computers can exchange data by MAC address.

4.8.1.2 ARP Spoofing

In terms of ARP Protocol design, to reduce redundant ARP data communication on networks, even though a host computer receives an ARP reply which is not requested by itself, it will also insert an entry to its ARP cache table, so it creates a possibility of “ARP spoofing”. If the hacker wants to snoop the communication between two host computers in the same network (even if are connected by the switches), it sends an ARP reply packet to two hosts separately, and make them

misunderstand MAC address of the other side as the hacker host MAC address. In this way, the direct communication is actually communicated indirectly among the hacker host computer. The hackers not only obtain communication information they need, but also only need to modify some information in data packet and forward successfully. In this sniff way, the hacker host computer doesn't need to configure intermix mode of network card, that is because the data packet between two communication sides are sent to hacker host computer on physical layer, which works as a relay.

4.8.1.3 How to prevent void ARP Spoofing

There are many sniff, monitor and attack behaviors based on ARP protocol in networks, and most of attack behaviors are based on ARP spoofing, so it is very important to prevent ARP spoofing. ARP spoofing accesses normal network environment by counterfeiting legal IP address firstly, and sends a great deal of counterfeited ARP application packets to switches, after switches learn these packets, they will cover previously corrected IP, mapping of MAC address, and then some corrected IP, MAC address mapping are modified to correspondence relationship configured by attack packets so that the switch makes mistake on transfer packets, and takes an effect on the whole network. Or the switches are made used of by vicious attackers, and they intercept and capture packets transferred by switches or attack other switches, host computers or network equipment.

What the essential method on preventing attack and spoofing switches based on ARP in networks is to disable switch automatic update function; the cheater can't modify corrected MAC address in order to avoid wrong packets transfer and can't obtain other information. At one time, it doesn't interrupt the automatic learning function of ARP. Thus it prevents ARP spoofing and attack to a great extent.

4.8.2 Prevent ARP Spoofing configuration

The steps of preventing ARP spoofing configuration as below:

1. Disable ARP automatic update function
2. Disable ARP automatic learning function
3. Changing dynamic ARP to static ARP

1. Disable ARP automatic update function

Command	Explanation
Global Mode and Port Mode	
ip arp-security updateprotect no ip arp-security updateprotect	Disable and enable ARP automatic update function.

2. Disable ARP automatic learning function

Command	Explanation
Global mode and Interface Mode	
ip arp-security learnprotect	Disable and enable ARP automatic learning

no ip arp-security learnprotect	function.
--	-----------

3. Function on changing dynamic ARP to static ARP

Command	Explanation
Global Mode and Port Mode	
ip arp-security convert	Change dynamic ARP to static ARP.

4.8.3 Prevent ARP Spoofing Example

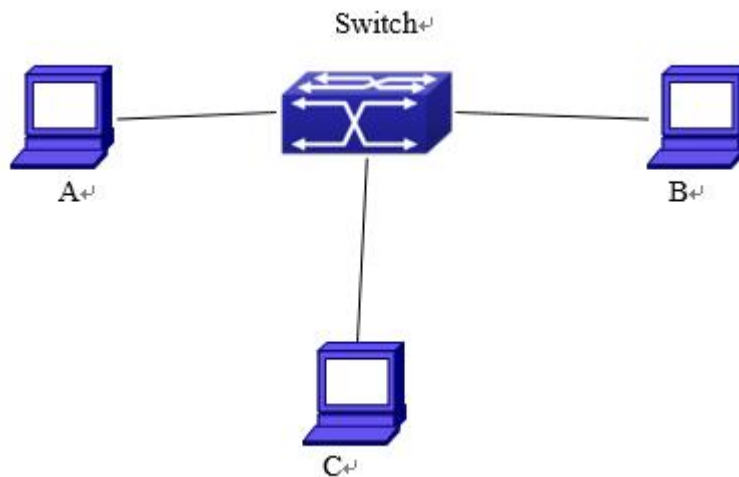

Equipment Explanation

Equipment	Configuration	Quality
switch	IP:192.168.2.4; IP:192.168.1.4; mac: 00-00-00-00-00-04	1
A	IP:192.168.2.1; mac: 00-00-00-00-00-01	1
B	IP:192.168.1.2; mac: 00-00-00-00-00-02	1
C	IP:192.168.2.3; mac: 00-00-00-00-00-03	some

There is a normal communication between B and C on above diagram. A wants switch to forward packets sent by B to itself, so need switch sends the packets transfer from B to A. firstly A sends ARP reply packet to switch, format is: 192.168.2.3, 00-00-00-00-00-01, mapping its MAC address to C's IP, so the switch changes IP address when it updates ARP list., then data packet of 192.168.2.3 is transferred to 00-00-00-00-00-01 address (A MAC address).

In further, a transfers its received packets to C by modifying source address and destination address, the mutual communicated data between B and C are received by A unconsciously. Because the ARP list is update timely, another task for A is to continuously send ARP reply packet, and refreshes switch ARP list.

So it is very important to protect ARP list, configure to forbid ARP learning command in stable environment, and then change all dynamic ARP to static ARP, the learned ARP will not be refreshed, and protect for users.

```
Switch#config
```

```
Switch(config)#interface vlan 1
```

```
Switch(Config-If-Vlan1)#arp 192.168.2.1 00-00-00-00-00-01 interface eth 1/0/2
Switch(Config-If-Vlan1)#interface vlan 2
Switch(Config-If-Vlan2)#arp 192.168.1.2 00-00-00-00-00-02 interface eth 1/0/2
Switch(Config-If-Vlan2)#interface vlan 3
Switch(Config-If-Vlan3)#arp 192.168.2.3 00-00-00-00-00-03 interface eth 1/0/2
Switch(Config-If-Vlan3)#exit
Switch(Config)#ip arp-security learnprotect
Switch(Config)#
Switch(config)#ip arp-security convert
```

If the environment changing, it enable to forbid ARP refresh, once it learns ARP property, it wont be refreshed by new ARP reply packet, and protect use data from sniffing.

```
Switch#config
Switch(config)#ip arp-security updateprotect
```

4.9 ARP GUARD

4.9.1 Introduction to ARP GUARD

There is serious security vulnerability in the design of ARP protocol, which is any network device, can send ARP messages to advertise the mapping relationship between IP address and MAC address. This provides a chance for ARP cheating. Attackers can send ARP REQUEST messages or ARP REPLY messages to advertise a wrong mapping relationship between IP address and MAC address, causing problems in network communication. The danger of ARP cheating has two forms: 1. PC4 sends an ARP message to advertise that the IP address of PC2 is mapped to the MAC address of PC4, which will cause all the IP messages to PC2 will be sent to PC4, thus PC4 will be able to monitor and capture the messages to PC2; 2. PC4 sends ARP messages to advertise that the IP address of PC2 is mapped to an illegal MAC address, which will prevent PC2 from receiving the messages to it. Particularly, if the attacker pretends to be the gateway and do ARP cheating, the whole network will be collapsed.

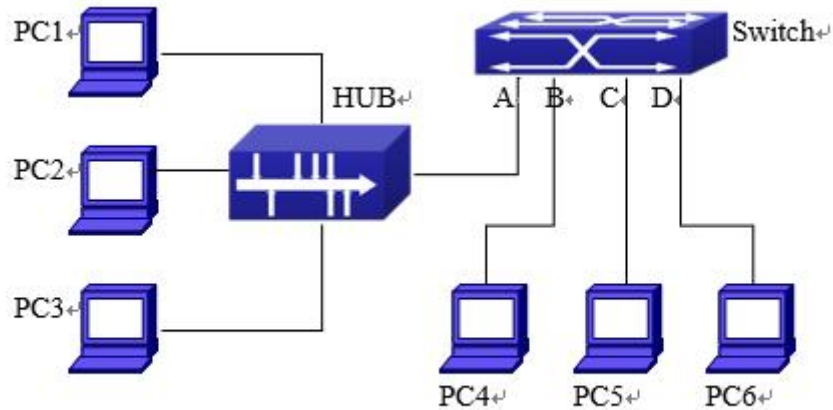

Figure 3-7 ARP GUARD schematic diagram

We utilize the filtering entries of the switch to protect the ARP entries of important network devices from being imitated by other devices. The basic theory of doing this is that utilizing the filtering entries of the switch to check all the ARP messages entering through the port, if the source address of the ARP message is protected, the messages will be directly dropped and will not be forwarded.

ARP GUARD function is usually used to protect the gateway from being attacked. If all the accessed PCs in the network should be protected from ARP cheating, then a large number of ARP GUARD address should be configured on the port, which will take up a big part of FFP entries in the chip, and as a result, might affect other applications. So this will be improper. It is recommended that adopting FREE RESOURCE related accessing scheme. Please refer to relative documents for details.

4.9.2 ARP GUARD Configuration Task List

1. Configure the protected IP address

Command	Explanation
Port configuration mode	
arp-guard ip <addr> no arp-guard ip <addr>	Configure/delete ARP GUARD address

4.10 ARP Local Proxy

4.10.1 Introduction to ARP Local Proxy function

In a real application environment, the switches in the aggregation layer are required to implement local ARP proxy function to avoid ARP cheating. This function will restrict the

forwarding of ARP messages in the same vlan and thus direct the L3 forwarding of the data flow through the switch.

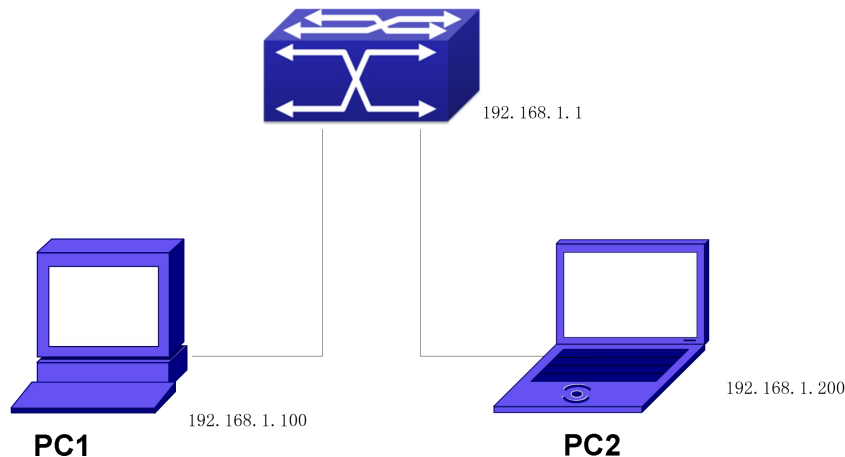

Figure 3-8

As shown in the figure above, PC1 wants to send an IP message to PC2, the overall procedure goes as follows (some non-arp details are ignored)

1. Since PC1 does not have the ARP of PC2, it sends and broadcasts ARP request.
2. Receiving the ARP message, the switch hardware will send the ARP request to CPU instead of forwarding this message via hardware, according to new ARP handling rules.
3. With local ARP proxy enabled, the switch will send ARP reply message to PC1 (to fill up its mac address)
4. After receiving the ARP reply, PC1 will create ARP, send an IP message, and set the destination MAC of the Ethernet head as the MAC of the switch.
5. After receiving the ip message, the switch will search the router table (to create router cache) and distribute hardware entries.
6. If the switch has the ARP of PC2, it will directly encapsulate the Ethernet head and send the message (the destination MAC is that of PC2)
7. If the switch does not have the ARP of PC2, it will request it and then send the ip message.

This function should cooperate with other security functions. When users configure local ARP proxy on an aggregation switch while configuring interface isolation function on the layer-2 switch connected to it, all ip flow will be forwarded on layer 3 via the aggregation switch. And due to the interface isolation, ARP messages will not be forwarded within the vlan, which means other PCs will not receive it.

4.10.2 ARP Local Proxy Function Configuration Task

List

1. Enable/disable ARP local proxy function

1. Enable/disable ARP local proxy function

Command	Explanation
---------	-------------

Interface vlan mode	
ip local proxy-arp no ip local proxy-arp	Enable or disable ARP local proxy function.

4.10.3 Typical Examples of ARP Local Proxy Function

As shown in the following figure, S1 is a medium/high-level layer-3 switch supporting ARP local proxy, S2 is layer-2 access switches supporting interface isolation.

Considering security, interface isolation function is enabled on S2. Thus all downlink ports of S2 is isolated from each other, making all ARP messages able to be forwarded through S1. If ARP local proxy is enabled on S1, then all interfaces on S1 isolate ARP while S1 serves as an ARP proxy. As a result, IP flow will be forwarded at layer 3 through S1 instead of S2.

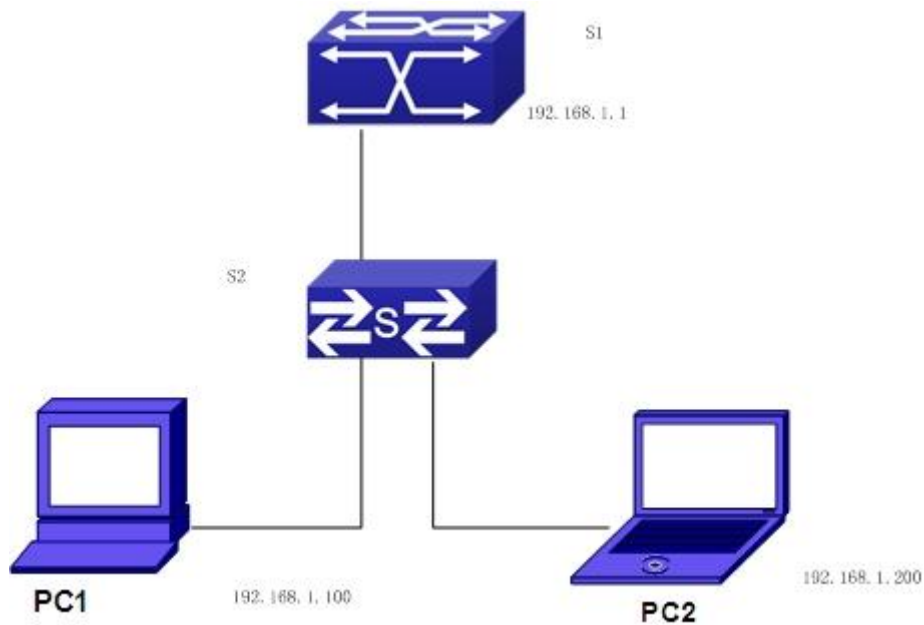

Figure 3-9

We can configure as follows:

```
Switch(config)#interface vlan 1
Switch(Config-if-Vlan1)#ip address 192.168.1.1 255.255.255.0
Switch(Config-if-Vlan1)#ip local proxy-arp
Switch(Config-if-Vlan1)#exit
```

4.10.4 ARP Local Proxy Function Troubleshooting

ARP local proxy function is disabled by default. Users can view the current configuration with display command. With correct configuration, by enabling debug of ARP, users can check whether the ARP proxy is normal and send proxy ARP messages.

In the process of operation, the system will show corresponding prompts if any operational error occurs.

4.11 Gratuitous ARP Configuration

4.11.1 Introduction to Gratuitous ARP

Gratuitous ARP is a kind of ARP request that is sent by the host with its IP address as the destination of the ARP request.

The basic working mode for the switch is as below: The Layer 3 interfaces of the switch can be configured to advertise gratuitous ARP packets period or the switch can be configured to enable to send gratuitous ARP packets in all the interfaces globally.

The purpose of gratuitous ARP is as below:

1. To reduce the frequency that the host sends ARP request to the switch. The hosts in the network will periodically send ARP requests to the gateway to update the MAC address of the gateway. If the switch advertises gratuitous ARP requests, the host will not have to send these requests. This will reduce the frequency the hosts' sending ARP requests for the gateway's MAC address.
2. Gratuitous ARP is a method to prevent ARP cheating. The switch's advertising gratuitous ARP request will force the hosts to update its ARP table cache. Thus, forged ARP of gateway cannot function.

4.11.2 Gratuitous ARP Configuration Task List

1. Enable gratuitous ARP and configure the interval to send gratuitous ARP request
2. Display configurations about gratuitous ARP

1. Enable gratuitous ARP and configure the interval to send gratuitous ARP request.

Command	Explanation
Global Configuration Mode and Interface Configuration Mode.	
ip gratuitous-arp <5-1200> no ip gratuitous-arp	To enable gratuitous ARP and configure the interval to send gratuitous ARP request. The no command cancels the gratuitous ARP.

2. Display configurations about gratuitous ARP

Command	Explanation
Admin Mode and Configuration Mode	
show ip gratuitous-arp [interface vlan <1-4094>]	To display configurations about gratuitous ARP.

4.11.3 Gratuitous ARP Configuration Example

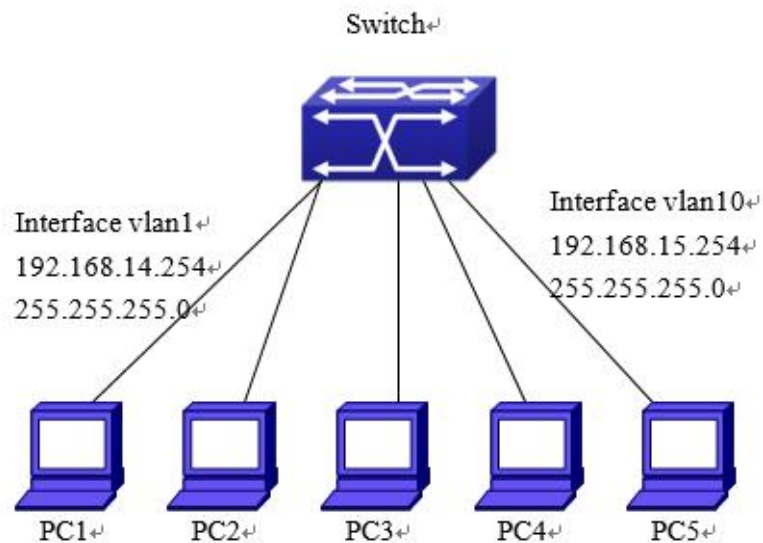

Figure 3-10 Gratuitous ARP Configuration Example

For the network topology shown in the figure above, interface VLAN10 whose IP address is 192.168.15.254 and network address mask is 255.255.255.0 in the switch system. Three PCs – PC3, PC4, PC5 are connected to the interface. The IP address of interface VLAN 1 is 192.168.14.254, its network address mask is 255.255.255.0. Two PCs – PC1 and PC2 are connected to this interface. Gratuitous ARP can be enabled through the following configuration:

1. Configure two interfaces to use gratuitous ARP at one time.

```
Switch(config)#ip gratuitous-arp 300
Switch(config)#exit
```

2. Configure gratuitous ARP specifically for only one interface at one time.

```
Switch(config)#interface vlan 10
Switch(Config-if-Vlan10)#ip gratuitous-arp 300
Switch(Config-if-Vlan10)#exit
Switch(config) #exit
```

4.11.4 Gratuitous ARP Troubleshooting

Gratuitous ARP is disabled by default. And when gratuitous ARP is enabled, the debugging information about ARP packets can be retrieved through the command `debug arp send`.

If gratuitous ARP is enabled in global configuration mode, it can be disabled only in global configuration mode. If gratuitous ARP is configured in interface configuration mode, the configuration can only be disabled in interface configuration mode.

4.12 Keepalive Gateway

4.12.1 Introduction to Keepalive Gateway

Ethernet port is used to process backup or load balance, for the reason that it is a broadcast channel, it may not detect the change of physical signal and fails to get to down when the gateway is down. Keepalive Gateway is introduced to detect the connectivity to the higher-up gateway, in the case that a Ethernet port connect with a higher-up gateway to form a point-to-point network topology.

For example: router connects optical terminal device and the line is up all the time, While the line between moden and remote gateway is down, it is necessary to use a effective method to detect whether the remote gateway is reachable. At present, detect gateway connectivity by sending ARP request to gateway on time, if ARP resolution is failing, shutdown the interface, if ARP resolution is successful, keep the interface up.

Only layer 3 switch supports keepalive gateway function.

4.12.2 Keepalive Gateway Configuration Task List

1. Enable or disable keepalive gateway, configure the interval period that ARP request packet is sent and the retry-count after detection is failing
2. Show keepalive gateway and IPv4 running status of the interface

1. Enable or disable keepalive gateway, configure the interval period that ARP request packet is sent and the retry-count after detection is failing

Command	Explanation
Interface mode	
keepalive gateway <ip-address> [{<interval-seconds> msec } [retry-count]] no keepalive gateway	Enable keepalive gateway, configure IP address of gateway, the interval period that ARP request packet is sent, and the retry-count after detection is failing, the no command disables the function.

2. Show keepalive gateway and IPv4 running status of interface

Command	Explanation
Admin and configuration mode	
show keepalive gateway [interface-name]	Show keepalive running status of the specified interface, if there is no interface is specified,

	show keepalive running status of all interfaces.
show ip interface [interface-name]	Show IPv4 running status of the specified interface, if there is no interface is specified, show IPv4 running status of all interfaces.

4.12.3 Keepalive Gateway Example

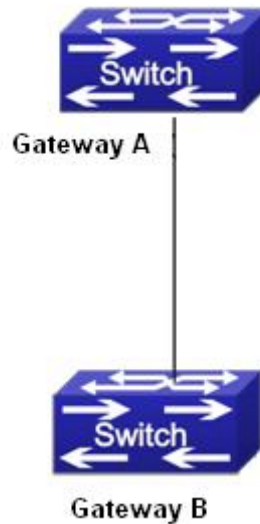

Figure 3- 11keepalive gateway typical example

In above network topology, interface address of interface vlan10 is 1.1.1.1 255.255.255.0 for gateway A, interface address of interface vlan100 is 1.1.1.2 255.255.255.0 for gateway B, gateway B supports keepalive gateway function, the configuration in the following:

1. Adopt the default interval that ARP packet is sent and the retry-count after detection is failing (the default interval is 10s, the default retry-count is 5 times)

```
Switch(config)#interface vlan 100
Switch(config-if-vlan100)#keepalive gateway 1.1.1.1
Switch(config-if-vlan100)#exit
```

2. Configure the interval that ARP packet is sent and the retry-count after detection is failing manually.

```
Switch(config)#interface vlan 100
Switch(config-if-vlan100)#keepalive gateway 1.1.1.1 3 3
Switch(config-if-vlan100)#exit
```

Send ARP detection once 3 seconds to detect whether gateway A is reachable, after 3 times detection is failing, gateway A is considered to be unreachable.

4.12.4 Keping Gateway Troubleshooting

If there is any problem happens when using keepalive gateway function, please check whether the problem is caused by the following reasons:

- ✎ Make sure the device is layer 3 switch, layer 2 switch does not support keepalive gateway
- ✎ The detection method is used to point-to-point topology mode only
- ✎ Detect IPv4 accessibility by the method, so the detection result only affects IPv4 traffic, other traffic such as IPv6 is not affected
- ✎ Physical state of interface only controlled by physical signal
- ✎ Interface can't run IPv4 after determine gateway is not reachable, so all relative IPv4 routes are deleted and IPv4 route protocol can't establish the neighbor on the interface

4.13 DHCP

4.13.1 Introduction to DHCP

DHCP [RFC2131] is the acronym for Dynamic Host Configuration Protocol. It is a protocol that assigns IP address dynamically from the address pool as well as other network configuration parameters such as default gateway, DNS server, and default route and host image file position within the network. DHCP is the enhanced version of BOOTP. It is a mainstream technology that can not only provide boot information for diskless workstations, but can also release the administrators from manual recording of IP allocation and reduce user effort and cost on configuration. Another benefit of DHCP is it can partially ease the pressure on IP demands, when the user of an IP leaves the network that IP can be assigned to another user.

DHCP is a client-server protocol, the DHCP client requests the network address and configuration parameters from the DHCP server; the server provides the network address and configuration parameters for the clients; if DHCP server and clients are located in different subnets, DHCP relay is required for DHCP packets to be transferred between the DHCP client and DHCP server. The implementation of DHCP is shown below:

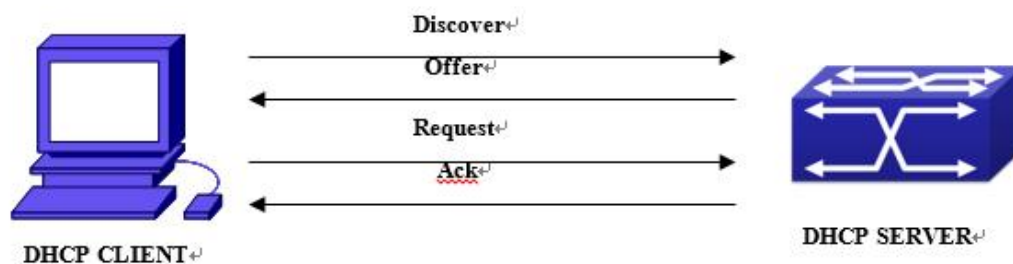

Figure 3- 12 DHCP protocol interaction

Explanation:

1. DHCP client broadcasts DHCPDISCOVER packets in the local subnet.
2. On receiving the DHCPDISCOVER packet, DHCP server sends a DHCPOFFER packet along with IP address and other network parameters to the DHCP client.

3. DHCP client broadcast DHCPREQUEST packet with the information for the DHCP server it selected after selecting from the DHCPOFFER packets.
4. The DHCP server selected by the client sends a DHCPACK packet and the client gets an IP address and other network configuration parameters.

The above four steps finish a Dynamic host configuration assignment process. However, if the DHCP server and the DHCP client are not in the same network, the server will not receive the DHCP broadcast packets sent by the client, therefore no DHCP packets will be sent to the client by the server. In this case, a DHCP relay is required to forward such DHCP packets so that the DHCP packets exchange can be completed between the DHCP client and server.

Switch can act as both a DHCP server and a DHCP relay. DHCP server supports not only dynamic IP address assignment, but also manual IP address binding (i.e. specify a specific IP address to a specified MAC address or specified device ID over a long period. The differences and relations between dynamic IP address allocation and manual IP address binding are: 1) IP address obtained dynamically can be different every time; manually bound IP address will be the same all the time. 2) The lease period of IP address obtained dynamically is the same as the lease period of the address pool, and is limited; the lease of manually bound IP address is theoretically endless. 3) Dynamically allocated address cannot be bound manually. 4) Dynamic DHCP address pool can inherit the network configuration parameters of the dynamic DHCP address pool of the related segment.

4.13.2 DHCP Server Configuration

DHCP Sever Configuration Task List:

1. Enable/Disable DHCP service
2. Configure DHCP Address pool
 - (1) Create/Delete DHCP Address pool
 - (2) Configure DHCP address pool parameters
 - (3) Configure manual DHCP address pool parameters
3. Enable logging for address conflicts

1.	Enable/Disable	DHCP	service

Command	Explanation
Global Mode	
service dhcp	Enable DHCP server. The no command
no service dhcp	disables DHCP server.

2. Configure DHCP Address pool

- (1) Create/Delete DHCP Address pool

Command	Explanation
Global Mode	
ip dhcp pool <name> no ip dhcp pool <name>	Configure DHCP Address pool. The no operation cancels the DHCP Address pool.

(2) Configure DHCP address pool parameters

Command	Explanation
DHCP Address Pool Mode	
network-address <network-number> [mask prefix-length] no network-address	Configure the address scope that can be allocated to the address pool. The no operation of this command cancels the allocation address pool.
default-router [<address1> <address2>[...<address8>]] no default-router	Configure default gateway for DHCP clients. The no operation cancels the default gateway.
dns-server [<address1> <address2>[...<address8>]] no dns-server	Configure DNS server for DHCP clients. The no command deletes DNS server configuration.
domain-name <domain> no domain-name	Configure Domain name for DHCP clients; the “ no domain-name ” command deletes the domain name.
netbios-name-server [<address1> <address2>[...<address8>]] no netbios-name-server	Configure the address for WINS server. The no operation cancels the address for server.
netbios-node-type {b-node h-node m-node p-node <type-number>} no netbios-node-type	Configure node type for DHCP clients. The no operation cancels the node type for DHCP clients.
bootfile <filename> no bootfile	Configure the file to be imported for DHCP clients on boot up. The no command cancels this operation.
next-server [<address1> <address2>[...<address8>]] no next-server [<address1> <address2>[...<address8>]]	Configure the address of the server hosting file for importing. The no command deletes the address of the server hosting file for importing.
option <code> {ascii <string> hex <hex> ipaddress <ipaddress>} no option <code>	Configure the network parameter specified by the option code. The no command deletes the network parameter specified by the option code.
lease { days [hours][minutes] infinite } no lease	Configure the lease period allocated to addresses in the address pool. The no command deletes the lease period allocated to addresses in the address pool.
max-lease-time {<days> [<hours>] [<minutes>] infinite}	Set the maximum lease time for the addresses in the address pool; the no command restores

no max-lease-time	the default setting.
Global Mode	
ip dhcp excluded-address <low-address> [<high-address>] no ip dhcp excluded-address <low-address> [<high-address>]	Exclude the addresses in the address pool that are not for dynamic allocation.

(3) Configure manual DHCP address pool parameters

Command	Explanation
DHCP Address Pool Mode	
hardware-address <hardware-address> [{Ethernet IEEE802} <type-number>] no hardware-address	Specify/delete the hardware address when assigning address manually.
host <address> [<mask> <prefix-length>] no host	Specify/delete the IP address to be assigned to the specified client when binding address manually.
client-identifier <unique-identifier> no client-identifier	Specify/delete the unique ID of the user when binding address manually.

3. Enable logging for address conflicts

Command	Explanation
Global Mode	
ip dhcp conflict logging no ip dhcp conflict logging	Enable/disable logging for DHCP address to detect address conflicts.
Admin Mode	
clear ip dhcp conflict <address all >	Delete a single address conflict record or all conflict records.

4.13.3 DHCP Relay Configuration

When the DHCP client and server are in different segments, DHCP relay is required to transfer DHCP packets. Adding a DHCP relay makes it unnecessary to configure a DHCP server for each segment, one DHCP server can provide the network configuration parameter for clients from multiple segments, which is not only cost-effective but also management-effective.

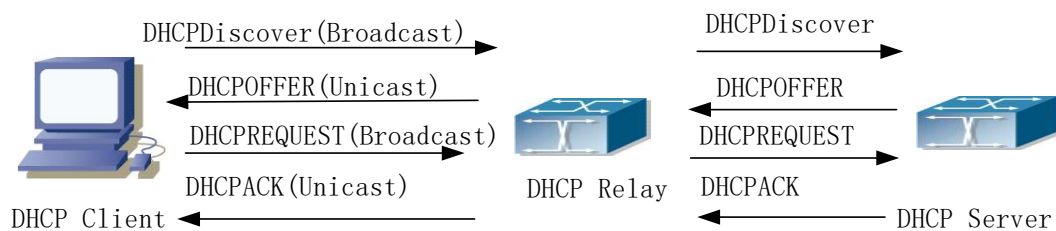

Figure 3- 13 DHCP relay

As shown in the above figure, the DHCP client and the DHCP server are in different

networks, the DHCP client performs the four DHCP steps as usual yet DHCP relay is added to the process.

1. The client broadcasts a DHCPDISCOVER packet, and DHCP relay inserts its own IP address to the relay agent field in the DHCPDISCOVER packet on receiving the packet, and forwards the packet to the specified DHCP server (for DHCP frame format, please refer to RFC2131).
2. On the receiving the DHCPDISCOVER packets forwarded by DHCP relay, the DHCP server sends the DHCPOFFER packet via DHCP relay to the DHCP client.
3. DHCP client chooses a DHCP server and broadcasts a DHCPREQUEST packet, DHCP relay forwards the packet to the DHCP server after processing.
4. On receiving DHCPREQUEST, the DHCP server responds with a DHCPACK packet via DHCP relay to the DHCP client.

DHCP Relay Configuration Task List:

1. Enable DHCP relay.
2. Configure DHCP relay to forward DHCP broadcast packet.

1. Enable DHCP relay.

Command	Explanation
Global Mode	
service dhcp no service dhcp	DHCP server and DHCP relay is enabled as the DHCP service is enabled.

2. Configure DHCP relay to forward DHCP broadcast packet.

Command	Explanation
Global Mode	
ip forward-protocol udp bootps no ip forward-protocol udp bootps	The UDP port 67 is used for DHCP broadcast packet forwarding.
Interface Configuration Mode	
ip helper-address <ipaddress> no ip helper-address <ipaddress>	Set the destination IP address for DHCP relay forwarding; the “ no ip helper-address <ipaddress> ” command cancels the setting.

4.13.4 DHCP Configuration Examples

Scenario 1:

Too save configuration efforts of network administrators and users, a company is using switch as a DHCP server. The Admin VLAN IP address is 10.16.1.2/16. The local area network for the company is divided into network A and B according to the office locations. The network configurations for location A and B are shown below.

PoolA(network 10.16.1.0)		PoolB(network 10.16.2.0)	
Device	IP address	Device	IP address
Default gateway	10.16.1.200	Default gateway	10.16.1.200
	10.16.1.201		10.16.1.201

DNS server	10.16.1.202	DNS server	10.16.1.202
WINS server	10.16.1.209	WWW server	10.16.1.209
WINS node type	H-node		
Lease	3 days	Lease	1 day

In location A, a machine with MAC address 00-03-22-23-dc-ab is assigned with a fixed IP address of 10.16.1.210 and named as “management”.

```
Switch(config)#service dhcp
Switch(config)#interface vlan 1
Switch(Config-Vlan-1)#ip address 10.16.1.2 255.255.0.0
Switch(Config-Vlan-1)#exit
Switch(config)#ip dhcp pool A
Switch(dhcp-A-config)#network 10.16.1.0 24
Switch(dhcp-A-config)#lease 3
Switch(dhcp-A-config)#default-route 10.16.1.200 10.16.1.201
Switch(dhcp-A-config)#dns-server 10.16.1.202
Switch(dhcp-A-config)#netbios-name-server 10.16.1.209
Switch(dhcp-A-config)#netbios-node-type H-node
Switch(dhcp-A-config)#exit
Switch(config)#ip dhcp excluded-address 10.16.1.200 10.16.1.201
Switch(config)#ip dhcp pool B
Switch(dhcp-B-config)#network 10.16.2.0 24
Switch(dhcp-B-config)#lease 1
Switch(dhcp-B-config)#default-route 10.16.2.200 10.16.2.201
Switch(dhcp-B-config)#dns-server 10.16.2.202
Switch(dhcp-B-config)#option 72 ip 10.16.2.209
Switch(dhcp-config)#exit
Switch(config)#ip dhcp excluded-address 10.16.2.200 10.16.2.201
Switch(config)#ip dhcp pool A1
Switch(dhcp-A1-config)#host 10.16.1.210
Switch(dhcp-A1-config)#hardware-address 00-03-22-23-dc-ab
Switch(dhcp-A1-config)#exit
```

Usage Guide: When a DHCP/BOOTP client is connected to a VLAN1 port of the switch, the client can only get its address from 10.16.1.0/24 instead of 10.16.2.0/24. This is because the broadcast packet from the client will be requesting the IP address in the same segment of the VLAN interface after VLAN interface forwarding, and the VLAN interface IP address is 10.16.1.2/24, therefore the IP address assigned to the client will belong to 10.16.1.0/24.

If the DHCP/BOOTP client wants to have an address in 10.16.2.0/24, the gateway forwarding broadcast packets of the client must belong to 10.16.2.0/24. The connectivity between the client gateway and the switch must be ensured for the client to get an IP address from the 10.16.2.0/24 address pool.

Scenario 2:

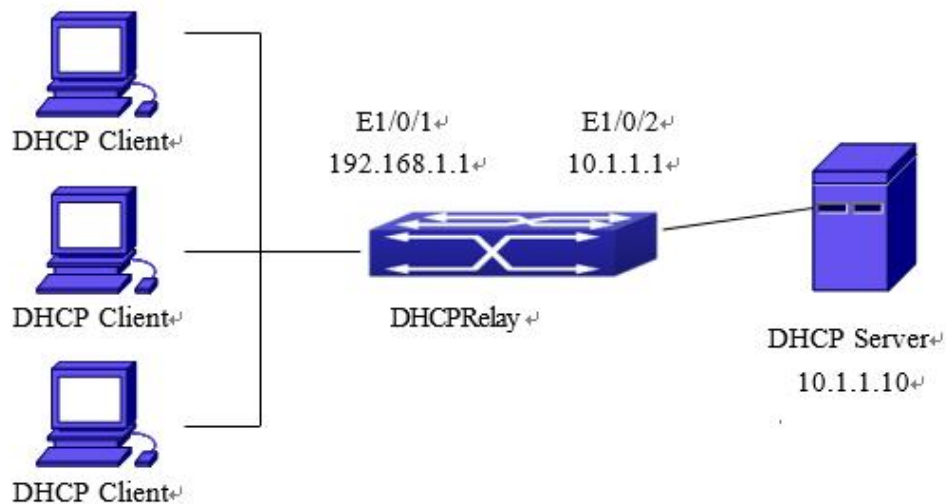

Figure 3- 14 DHCP Relay Configuration

As shown in the above figure, route switch is configured as a DHCP relay. The DHCP server address is 10.1.1.10, the configuration steps is as follows:

```
Switch(config)#service dhcp
Switch(config)#interface vlan 1
Switch(Config-if-Vlan1)#ip address 192.168.1.1 255.255.255.0
Switch(Config-if-Vlan1)#exit
Switch(config)#vlan 2
Switch(Config-Vlan-2)#exit
Switch(config)#interface Ethernet 1/0/2
Switch(Config-Erthetnet1/0/2)#switchport access vlan 2
Switch(Config-Erthetnet1/0/2)#exit
Switch(config)#interface vlan 2
Switch(Config-if-Vlan2)#ip address 10.1.1.1 255.255.255.0
Switch(Config-if-Vlan2)#exit
Switch(config)#ip forward-protocol udp bootps
Switch(config)#interface vlan 1
Switch(Config-if-Vlan1)#ip help-address 10.1.1.10
Switch(Config-if-Vlan1)#exit
```

Note: It is recommended to use the combination of command **ip forward-protocol udp <port>** and **ip helper-address <ipaddress>**. **ip helper-address** can only be configured for ports on layer 3 and cannot be configured on layer 2 ports directly.

4.13.5 DHCP Troubleshooting

If the DHCP clients cannot obtain IP addresses and other network parameters, the following

procedures can be followed when DHCP client hardware and cables have been verified ok.

- ☞ Verify the DHCP server is running, start the related DHCP server if not running. If the DHCP clients and servers are not in the same physical network, verify the router responsible for DHCP packet forwarding has DHCP relay function. If DHCP relay is not available for the intermediate router, it is recommended to replace the router or upgrade its software to one that has a DHCP relay function.
- ☞ In such case, DHCP server should be examined for an address pool that is in the same segment of the switch VLAN, such a pool should be added if not present, and (This does not indicate switch cannot assign IP address for different segments, see solution 2 for details.)
- ☞ In DHCP service, pools for dynamic IP allocation and manual binding are conflicting, i.e., if command “**network-address**” and “**host**” are run for a pool, only one of them will take effect; furthermore, in manual binding, only one IP-MAC binding can be configured in one pool. If multiple bindings are required, multiple manual pools can be created and IP-MAC bindings set for each pool. New configuration in the same pool overwrites the previous configuration.

4.14 DHCP option 82

4.14.1 Introduction to DHCP option 82

DHCP option 82 is the Relay Agent Information Option, its option code is 82. DHCP option 82 is aimed at strengthening the security of DHCP servers and improving the IP address configuration policy. The Relay Agent adds option 82 (including the client’s physical access port, the access device ID and other information), to the DHCP request message from the client then forwards the message to DHCP server. When the DHCP server which supports the option 82 function receives the message, it will allocate an IP address and other configuration information for the client according to preconfigured policies and the option 82 information in the message. At the same time, DHCP server can identify all the possible DHCP attack messages according to the information in option 82 and defend against them. DHCP Relay Agent will peel the option 82 from the reply messages it receives, and forward the reply message to the specified port of the network access device, according to the physical port information in the option. The application of DHCP option 82 is transparent for the client.

4.14.1.1 DHCP option 82 Message Structure

A DHCP message can have several option segments; option 82 is one of them. It has to be placed after other options but before option 255. The following is its format:

Code	Len	Agent Information Field					
82	N	i1	i2	i3	i4	...	iN

Code: represents the sequence number of the relay agent information option, the option 82 is called so because RFC3046 is defined as 82.

Len: the number of bytes in Agent Information Field, not including the two bytes in Code segment and Len segment.

Option 82 can have several sub-options, and need at least one sub-option. RFC3046 defines the following two sub-options, whose formats are showed as follows:

SubOpt	Len	Sub-option Value					
1	N	s1	s2	s3	s4	...	sN

SubOpt	Len	Sub-option Value					
2	N	i1	i2	i3	i4	...	iN

SubOpt: the sequence number of sub-option, the sequence number of Circuit ID sub-option is 1, the sequence number of Remote ID sub-option is 2.

Len: the number of bytes in Sub-option Value, not including the two bytes in SubOpt segment and Len segment.

4.14.1.2 option 82 Working Mechanism

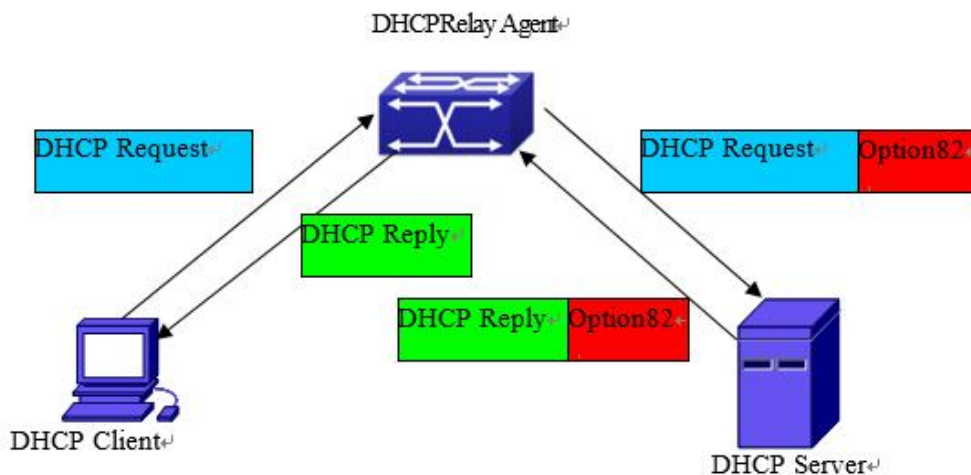

Figure 3- 15 DHCP option 82 flow chart

If the DHCP Relay Agent supports option 82, the DHCP client should go through the following four steps to get its IP address from the DHCP server: discover, offer, select and acknowledge. The DHCP protocol follows the procedure below:

- 1) DHCP client sends a request broadcast message while initializing. This request message does not have option 82.
- 2) DHCP Relay Agent will add the option 82 to the end of the request message it receives, then relay and forward the message to the DHCP server. By default, the sub-option 1 of option 82 (Circuit ID) is the interface information of the switch connected to the DHCP client (VLAN name and physical port name), but the users can configure the Circuit ID as they wish. The sub-option 2 of option 82(Remote ID) is the MAC address of the DHCP relay device.
- 3) After receiving the DHCP request message, the DHCP server will allocate IP address and other information for the client according to the information and preconfigured policy in the option segment of the message. Then it will forward the reply message with DHCP configuration information and option 82 information to DHCP Relay Agent.
- 4) DHCP Relay Agent will peel the option 82 information from the replay message sent by DHCP server, and then forward the message with DHCP configuration information to the DHCP client.

4.14.2 DHCP option 82 Configuration Task List

1. Enabling the DHCP option 82 of the Relay Agent
2. Configure the DHCP option 82 attributes of the interface
3. Enable the DHCP option 82 of server
4. Configure DHCP option 82 default format of Relay Agent
5. Configure delimiter
6. Configure creation method of option82
7. Diagnose and maintain DHCP option 82

1. Enabling the DHCP option 82 of the Relay Agent.

Command	Explanation
Global mode	
ip dhcp relay information option no ip dhcp relay information option	Set this command to enable the option 82 function of the switch Relay Agent. The “no ip dhcp relay information option” is used to disable the option 82 function of the switch Relay Agent.

2. Configure the DHCP option 82 attributes of the interface

Command	Explanation
Interface configuration mode	
ip dhcp relay information policy {drop keep replace} no ip dhcp relay information policy	This command is used to set the retransmitting policy of the system for the received DHCP request message which contains option 82. The drop mode means that if the message has option82, then the

	<p>system will drop it without processing; keep mode means that the system will keep the original option 82 segment in the message, and forward it to the server to process; replace mode means that the system will replace the option 82 segment in the existing message with its own option 82, and forward the message to the server to process. The “no ip dhcp relay information policy” will set the retransmitting policy of the option 82 DHCP message as “replace”.</p>
<pre>ip dhcp relay information option subscriber-id {standard <ircuit-id>} no ip dhcp relay information option subscriber-id</pre>	<p>This command is used to set the format of option 82 sub-option1(Circuit ID option) added to the DHCP request messages from interface, standard means the standard VLAN name and physical port name format, like”Vlan2+Ethernet1/0/12”,<ircuit-id> is the circuit-id contents of option 82 specified by users, which is a string no longer than 64characters. The” no ip dhcp relay information option subscriber-id” command will set the format of added option 82 sub-option1 (Circuit ID option) as standard format.</p>
Global Mode	
<pre>ip dhcp relay information option remote-id {standard <remote-id>} no ip dhcp relay information option remote-id</pre>	<p>Set the suboption2 (remote ID option) content of option 82 added by DHCP request packets (They are received by the interface). The no command sets the additive suboption2 (remote ID option) format of option 82 as standard.</p>

3. Enable the DHCP option 82 of server.

Command	Explanation
Global mode	
<pre>ip dhcp server relay information enable no ip dhcp server relay information enable</pre>	<p>This command is used to enable the switch DHCP server to identify option82. The “no ip dhcp server relay information enable” command will make the server ignore the option 82.</p>

4. Configure DHCP option 82 default format of Relay Agent

Command	Explanation
Global mode	

ip dhcp relay information option subscriber-id format {hex ascii vs-hp}	Set subscriber-id format of Relay Agent option82.
ip dhcp relay information option remote-id format {default vs-hp}	Set remote-id format of Relay Agent option82.

5. Configure delimiter

Command	Explanation
Global mode	
ip dhcp relay information option delimiter [colon dot slash space] no ip dhcp relay information option delimiter	Set the delimiter of each parameter for suboption of option82 in global mode, no command restores the delimiter as slash.

6. Configure creation method of option82

Command	Explanation
Global mode	
ip dhcp relay information option self-defined remote-id {hostname mac string WORD} no ip dhcp relay information option self-defined remote-id	Set creation method for option82, users can define the parameters of remote-id suboption by themselves
ip dhcp relay information option self-defined remote-id format [ascii hex]	Set self-defined format of remote-id for relay option82.
ip dhcp relay information option self-defined subscriber-id {vlan port id (switch-id (mac hostname) remote-mac) string WORD } no ip dhcp relay information option self-defined subscriber-id	Set creation method for option82, users can define the parameters of circute-id suboption by themselves
ip dhcp relay information option self-defined subscriber-id format [ascii hex]	Set self-defined format of circuit-id for relay option82.

7. Diagnose and maintain DHCP option 82

Command	Explanation
Admin mode	
show ip dhcp relay information option	This command will display the state information of the DHCP option 82 in the system, including option82 enabling switch, the interface retransmitting policy, the circuit ID mode and the DHCP server option82 enabling switch.
debug ip dhcp relay packet	This command is used to display the information of data packets processing in

	DHCP Relay Agent, including the “add” and “peel” action of option 82.
--	---

4.14.3 DHCP option 82 Application Examples

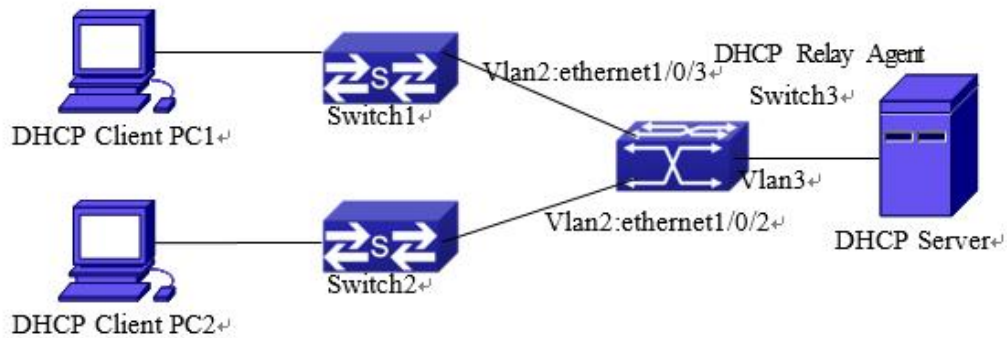

Figure 3- 16 A DHCP option 82 typical application example

In the above example, layer 2 switches Switch1 and Switch2 are both connected to layer 3 switch Switch3, Switch 3 will transmit the request message from DHCP client to DHCP server as DHCP Relay Agent. It will also transmit the reply message from the server to DHCP client to finish the DHCP protocol procedure. If the DHCP option 82 is disabled, DHCP server cannot distinguish that whether the DHCP client is from the network connected to Switch1 or Switch2. So, all the PC terminals connected to Switch1 and Switch2 will get addresses from the public address pool of the DHCP server. After the DHCP option 82 function is enabled, since the Switch3 appends the port information of accessing Switch3 to the request message from the client, the server can tell that whether the client is from the network of Switch1 or Switch2, and thus can allocate separate address spaces for the two networks, to simplify the management of networks.

The following is the configuration of Switch3(MAC address is 00:03:0f:02:33:01):

```
Switch3(Config)#service dhcp
Switch3(Config)#ip dhcp relay information option
Switch3(Config)#ip forward-protocol udp bootps
Switch3(Config)#interface vlan 3
Switch3(Config-if-vlan3)#ip address 192.168.10.222 255.255.255.0
Switch3(Config-if-vlan2)#ip address 192.168.102.2 255.255.255.0
Switch3(Config-if-vlan2)#ip helper 192.168.10.88
```

Linux ISC DHCP Server supports option 82, its configuration file /etc/dhcpd.conf is

```
ddns-update-style interim;
ignore client-updates;
```

```
class "Switch3Vlan2Class1" {
match if option agent.circuit-id = "Vlan2+Ethernet1/0/2" and option
agent.remote-id=00:03:0f:02:33:01;
}
```

```
class "Switch3Vlan2Class2" {
match    if    option    agent.circuit-id    =    "Vlan2+Ethernet1/0/3"    and    option
agent.remote-id=00:03:0f:02:33:01;
}

subnet 192.168.102.0 netmask 255.255.255.0 {
option routers 192.168.102.2;
option subnet-mask 255.255.255.0;
option domain-name "example.com.cn";
option domain-name-servers 192.168.10.3;
authoritative;

pool {
range 192.168.102.21 192.168.102.50;
default-lease-time 86400; #24 Hours
max-lease-time 172800; #48 Hours
allow members of "Switch3Vlan2Class1";
}
pool {
range 192.168.102.51 192.168.102.80;
default-lease-time 43200; #12 Hours
max-lease-time 86400; #24 Hours
allow members of "Switch3Vlan2Class2";
}
}
```

Now, the DHCP server will allocate addresses for the network nodes from Switch1 which are relayed by Switch3 within the range of 192.168.102.21 ~ 192.168.102.50, and allocate addresses for the network nodes from Switch1 within the range of 192.168.102.51 ~ 192.168.102.80.

4.14.4 DHCP option 82 Troubleshooting

- ✎ DHCP option 82 is implemented as a sub-function module of DHCP Relay Agent. Before using it, users should make sure that the DHCP Relay Agent is configured correctly.
- ✎ DHCP option 82 needs the DHCP Relay Agent and the DHCP server cooperate to finish the task of allocating IP addresses. The DHCP server should set allocating policy correctly depending on the network topology of the DHCP Relay Agent, or, even the Relay Agent can operate normally, the allocation of addresses will fail. When there is more than one kind of Relay Agent, please pay attention to the retransmitting policy of the interface DHCP request messages.
- ✎ To implement the option 82 function of DHCP Relay Agent, the “debug dhcp relay packet”

command can be used during the operating procedure, including adding the contents of option 82, the retransmitting policy adopted, the option 82 contents of the server peeled by the Relay Agent and etc., such information can help users to do troubleshooting.

- ☞ To implement the option 82 function of DHCP server, the “debug ip dhcp server packet” command can be used during the operating procedure to display the procedure of data packets processing of the server, including displaying the identified option 82 information of the request message and the option 82 information returned by the reply message.

4.15 DHCP Snooping

4.15.1 Introduction to DHCP Snooping

DHCP Snooping means that the switch monitors the IP-getting process of DHCP CLIENT via DHCP protocol. It prevents DHCP attacks and illegal DHCP SERVER by setting trust ports and untrust ports. And the DHCP messages from trust ports can be forwarded without being verified. In typical settings, trust ports are used to connect DHCP SERVER or DHCP RELAY Proxy, and untrust ports are used to connect DHCP CLINET. The switch will forward the DHCP request messages from untrust ports, but not DHCP reply ones. If any DHCP reply messages is received from a untrust port, besides giving an alarm, the switch will also implement designated actions on the port according to settings, such as “shutdown”, or distributing a “blackhole”. If DHCP Snooping binding is enabled, the switch will save binding information (including its MAC address, IP address, IP lease, VLAN number and port number) of each DHCP CLINET on untrust ports in DHCP snooping binding table. With such information, DHCP Snooping can combine modules like dot1x and ARP, or implement user-access-control independently.

Defense against Fake DHCP Server: once the switch intercepts the DHCP Server reply packets (including DHCP OFFER, DHCP ACK, and DHCP NAK), it will alarm and respond according to the situation (shutdown the port or send Black hole)。

Defense against DHCP over load attacks: To avoid too many DHCP messages attacking CPU, users should limit the DHCP speed of receiving packets on trusted and non-trusted ports.

Record the binding data of DHCP: DHCP SNOOPING will record the binding data allocated by DHCP SERVER while forwarding DHCP messages, it can also upload the binding data to the specified server to backup it. The binding data is mainly used to configure the dynamic users of dot1x user based ports. Please refer to the chapter called “dot1x configuration” to find more about the usage of dot1x use-based mode.

Add binding ARP: DHCP SNOOPING can add static binding ARP according to the binding data after capturing binding data, thus to avoid ARP cheating.

Add trusted users: DHCP SNOOPING can add trusted user list entries according to the parameters in binding data after capturing binding data; thus these users can access all resources

without DOT1X authentication.

Automatic Recovery: A while after the switch shut down the port or send blockhole, it should automatically recover the communication of the port or source MAC and send information to Log Server via syslog.

LOG Function: When the switch discovers abnormal received packets or automatically recovers, it should send syslog information to Log Server.

The Encryption of Private Messages: The communication between the switch and the inner network security management system TrustView uses private messages. And the users can encrypt those messages of version 2.

Add authentication option82 Function: It is used **with dot1x** dhcption82 authentication mode. Different option 82 will be added in DHCP messages according to user's authentication status.

4.15.2 DHCP Snooping Configuration Task Sequence

1. Enable DHCP Snooping
2. Enable DHCP Snooping binding function
3. Enable DHCP Snooping binding ARP function
4. Enable DHCP Snooping option82 function
5. Set the private packet version
6. Set DES encrypted key for private packets
7. Set helper server address
8. Set trusted ports
9. Enable DHCP Snooping binding DOT1X function
10. Enable DHCP Snooping binding USER function
11. Adding static list entries function
12. Set defense actions
13. Set rate limitation of DHCP messages
14. Enable the debug switch
15. Configure DHCP Snooping option 82 attributes

1. Enable DHCP Snooping

Command	Explanation
Globe mode	
ip dhcp snooping enable no ip dhcp snooping enable	Enable or disable the DHCP snooping function.

2. Enable DHCP Snooping binding

Command	Explanation
Globe mode	
ip dhcp snooping binding enable no ip dhcp snooping binding enable	Enable or disable the DHCP snooping binding function.

3. Enable DHCP Snooping binding ARP function

Command	Explanation
Globe mode	
ip dhcp snooping binding arp no ip dhcp snooping binding arp	Enable or disable the dhcp snooping binding ARP function.

4. Enable DHCP Snooping option82 function

Command	Explanation
Globe mode	
ip dhcp snooping information enable no ip dhcp snooping information enable	Enable/disable DHCP Snooping option 82 function.

5. Set the private packet version

Command	Explanation
Globe mode	
ip user private packet version two no ip user private packet version two	To configure/delete the private packet version.

6. Set DES encrypted key for private packets

Command	Explanation
Globe mode	
enable trustview key 0/7 <password> no enable trustview key	To configure/delete DES encrypted key for private packets.

7. Set helper server address

Command	Explanation
Globe mode	
ip user helper-address A.B.C.D [port <udpport>] source <ipAddr> (secondary) no ip user helper-address (secondary)	Set or delete helper server address.

8. Set trusted ports

Command	Explanation
Port mode	
ip dhcp snooping trust no ip dhcp snooping trust	Set or delete the DHCP snooping trust attributes of ports.

9. Enable DHCP SNOOPING binding DOT1X function

Command	Explanation
---------	-------------

Port mode	
ip dhcp snooping binding dot1x no ip dhcp snooping binding dot1x	Enable or disable the DHCP snooping binding dot1x function.

10. Enable or disable the DHCP SNOOPING binding USER function

Command	Explanation
Port mode	
ip dhcp snooping binding user-control no ip dhcp snooping binding user-control	Enable or disable the DHCP snooping binding user function.

11. Add static binding information

Command	Explanation
Globe mode	
ip dhcp snooping binding user <mac> address <ipAddr> vlan <vid> interface (ethernet) <ifname> no ip dhcp snooping binding user <mac> interface (ethernet) <ifname>	Add/delete DHCP snooping static binding list entries.

12. Set defense actions

Command	Explanation
Port mode	
ip dhcp snooping action {shutdown blackhole} [recovery <second>] no ip dhcp snooping action	Set or delete the DHCP snooping automatic defense actions of ports.

13. Set rate limitation of data transmission

Command	Explanation
Globe mode	
ip dhcp snooping limit-rate <pps> no ip dhcp snooping limit-rate	Set rate limitation of the transmission of DHCP snooping messages.

14. Enable the debug switch

Command	Explanation
Admin mode	
debug ip dhcp snooping packet debug ip dhcp snooping event debug ip dhcp snooping update	Please refer to the chapter on system troubleshooting.

debug ip dhcp snooping binding	
---------------------------------------	--

15. Configure DHCP Snooping option 82 attributes

Command	Explanation
Globe mode	
ip dhcp snooping information option subscriber-id format {hex acsii vs-hp}	This command is used to set subscriber-id format of DHCP snooping option82.
ip dhcp snooping information option remote-id {standard <remote-id>} no ip dhcp snooping information option remote-id	Set the suboption2 (remote ID option) content of option 82 added by DHCP request packets (they are received by the port). The no command sets the additive suboption2 (remote ID option) format of option 82 as standard.
ip dhcp snooping information option delimiter [colon dot slash space] no ip dhcp snooping information option delimiter	Set the delimiter of each parameter for suboption of option82 in global mode, no command restores the delimiter as slash.
ip dhcp snooping information option self-defined remote-id {hostname mac string WORD} no ip dhcp snooping information option self-defined remote-id	Set creation method for option82, users can define the parameters of remote-id suboption by themselves.
ip dhcp snooping information option self-defined remote-id format [ascii hex]	Set self-defined format of remote-id for snooping option82.
ip dhcp snooping information option self-defined subscriber-id {vlan port id (switch-id (mac hostname) remote-mac) string WORD} no ip dhcp snooping information option type self-defined subscriber-id	Set creation method for option82, users can define the parameters of circute-id suboption by themselves.
ip dhcp snooping information option self-defined subscriber-id format [ascii hex]	Set self-defined format of circuit-id for snooping option82.
Port mode	
ip dhcp snooping information option subscriber-id {standard <circuit-id>} no ip dhcp snooping information option subscriber-id	Set the suboption1 (circuit ID option) content of option 82 added by DHCP request packets (they are received by the port). The no command sets the additive suboption1 (circuit ID option) format of option 82 as standard.

Command	Explanation
Globe mode	

<p>ip dhcp snooping information option allow-untrusted (replace) no ip dhcp snooping information option allow-untrusted (replace)</p>	<p>This command is used to set that allow untrusted ports of DHCP snooping to receive DHCP packets with option82 option. When the "replace" is setting, the option82 option is allowed to replace. When disabling this command, all untrusted ports will drop DHCP packets with option82 option.</p>
--	--

4.15.3 DHCP Snooping Typical Application

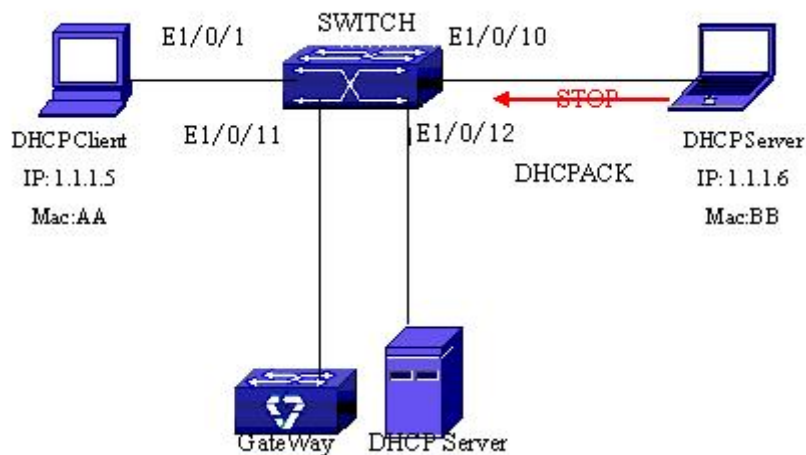

Figure 3- 17 Sketch Map of TRUNK

As showed in the above chart, Mac-AA device is the normal user, connected to the non-trusted port 1/0/1 of the switch. It operates via DHCP Client, IP 1.1.1.5; DHCP Server and GateWay are connected to the trusted ports 1/0/11 and 1/0/12 of the switch; the malicious user Mac-BB is connected to the non-trusted port 1/0/10, trying to fake a DHCP Server (by sending DHCPACK) . Setting DHCP Snooping on the switch will effectively detect and block this kind of network attack.

Configuration sequence is:

```
switch#
switch#config
switch(config)#ip dhcp snooping enable
switch(config)#interface ethernet 1/0/11
switch(Config-Ethernet1/0/11)#ip dhcp snooping trust
switch(Config-Ethernet1/0/11)#exit
switch(config)#interface ethernet 1/0/12
switch(Config-Ethernet1/0/12)#ip dhcp snooping trust
switch(Config-Ethernet1/0/12)#exit
switch(config)#interface ethernet 1/0/1-10
switch(Config-Port-Range)#ip dhcp snooping action shutdown
switch(Config-Port-Range)#
```

4.15.4 DHCP Snooping Troubleshooting Help

4.15.4.1 Monitor and Debug Information

The “debug ip dhcp snooping” command can be used to monitor the debug information.

4.15.4.2 DHCP Snooping Troubleshooting Help

If there is any problem happens when using DHCP Snooping function, please check if the problem is caused by the following reasons:

- ☞ Check that whether the global DHCP Snooping is enabled;
- ☞ If the port does not react to invalid DHCP Server packets, please check that whether the port is set as a non-trusted port of DHCP Snooping.

4.16 DHCP option 60 and option 43

4.16.1 Introduction to DHCP option 60 and option 43

DHCP server analyzes DHCP packets from DHCP client. If packets with option 60, it will decide whether option 43 is returned to DHCP client according to option 60 of packets and configuration of option 60 and option 43 in DHCP server address pool.

Configure the corresponding option 60 and option 43 in DHCP server address pool:

1. Address pool configured option 60 and option 43 at the same time. The received DHCP packet with option 60 from DHCP client, if it matches with option 60 of DHCP server address pool, DHCP client will receive the option 43 configured in the address pool, or else do not return option 43 to DHCP client.
2. Address pool only configured option 43, it will match with any option 60. If the received DHCP packet with option 60 from DHCP client, DHCP client will receive the option 43 configured in the address pool.
3. Address pool only configured option 60, it will not return option 43 to DHCP client.

4.16.2 DHCP option 60 and option 43 Configuration

Task List

1. Basic DHCP option 60 and option 43 configuration

Command	Explanation
Address pool configuration mode	
option 60 ascii LINE	Configure option 60 character

	string with ascii format in ip dhcp pool mode.
option 43 ascii LINE	Configure option 43 character string with ascii format in ip dhcp pool mode.
option 60 hex WORD	Configure option 60 character string with hex format in ip dhcp pool mode.
option 43 hex WORD	Configure option 43 character string with hex format in ip dhcp pool mode.
option 60 ip A.B.C.D	Configure option 60 character string with IP format in ip dhcp pool mode.
option 43 ip A.B.C.D	Configure option 43 character string with IP format in ip dhcp pool mode.
no option 60	Delete the configured option 60 in the address pool mode.
no option 43	Delete the configured option 43 in the address pool mode.

4.16.3 DHCPv6 option 60 and option 43 Example

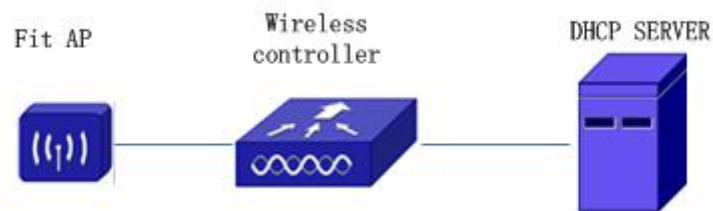

Figure 3- 18 Typical DHCP option 60 and option 43 topology

Fit AP obtains IP address and option 43 attribute by DHCP server to send unicast discovery request for wireless controller. DHCP server configures option 60 matched with the option 60 of fit ap to return option 43 attribute to FTP AP. The wireless controller addresses of DHCP option 43 are 192.168.10.5 and 192.168.10.6.

Configuration procedure:

```
# Configure DHCP server
```

```
switch (config)#ip dhcp pool a
```

```
switch (dhcp-a-config)#option 60 ascii AP1000
```

```
switch (dhcp-a-config)#option 43 hex 0104C0A80A050104C0A80A06
```

4.16.4 DHCP option 60 and option 43 Troubleshooting

If problems occur when configuring DHCP option 60 and option 43, please check whether the problem is caused by the following reasons:

- 👉 Check whether service dhcp function is enabled
- 👉 If the address pool configured option 60, check whether it matches with the option 60 of the packets

Chapter 5 Routing Protocol Related Configuration

5.1 Routing Protocol Overview

To communicate with a remote host over the Internet, a host must choose a proper route via a set of routers or Layer3 switches.

Both routers and layer3 switches calculate the route using CPU, the difference is that layer3 switch adds the calculated route to the switch chip and forward by the chip at wire speed, while the router always store the calculated route in the route table or route buffer, and data forwarding is performed by the CPU. For this reason, although both routers and switches can perform route selection, layer3 switches have great advantage over routers in data forwarding. The following describes basic principle and methods used in layer3 switch route selection.

In route selection, the responsibility of each layer3 switch is to select a proper midway route according to the destination of the packet received; and send the packet to the next layer3 switch until the last layer3 switch in the route send the packet to the destination host. A route is the path selected by each layer3 switch to pass the packet to the next layer3 switch. Route can be grouped into direct route, static route and dynamic route.

Direct route refer to the path directly connects to the layer3 switch, and can be obtained with no calculation.

Static route is the manually specified path to a network or a host; static route cannot be changed freely. The advantage of static route is simple and consistent, and it can limit illegal route modification, and is convenient for load balance and route backup. However, as this is set manually, it is not suitable for mid- or large-scale networks for the route in such conditions are too huge and complex.

Dynamic route is the path to a network or a host calculated by the layer3 switch according to the routing protocols enabled. If the next hop layer3 switch in the path is not reachable, layer3 switch will automatically discard the path to that next hop layer3 switch and choose the path through other layer3 switches.

There are two dynamic routing protocols: Interior Gateway Protocol (IGP) and Exterior Gateway protocol (EGP). IGP is the protocol used to calculate the route to a destination inside an autonomous system. IGP supported by switch include RIP and OSPF, RIP and OSRF can be configured according to the requirement. Switch supports running several IGP dynamic routing protocols at the same time. Or, other dynamic routing protocols and static route can be introduced to a dynamic routing protocol, so that multiple routing protocols can be associated.

EGP is used to exchange routing information among different autonomous systems, such as BGP protocol. EGP supported by switch include BGP-4, BGP-4+.

5.1.1 Routing Table

As mentioned before, layer3 switch is mainly used to establish the route from the current layer3 switch to a network or a host, and to forward packets according to the route. Each layer3 switch has its own route table containing all routes used by that switch. Each route entry in the route table specifies the physical port should be used for forwarding packet to reach a destination host or the next hop layer3 switch to the host.

The route table mainly consists of the following:

- 👉 Destination address: used to identify the destination address or destination network of an IP packet.
- 👉 Network mask: used together with destination address to identify the destination host or the network the layer3 switch resides. Network mask consists of several consecutive binary 1's, and usually in the format of dotted decimal (an address consists of 1 to 4 255's.) When "AND" the destination address with network mask, we can get the network address for the destination host or the network the layer3 switch resides. For example, the network address of a host or the segment the layer3 switch resides with a destination address of 200.1.1.1 and mask 255.255.255.0 is 200.1.1.0.
- 👉 Output interface: specify the interface of layer3 switch to forward IP packets.
- 👉 IP address of the next layer3 switch (next hop): specify the next layer3 switch the IP packet will pass.
- 👉 Route entry priority: There may be several different next hop routes leading to the same destination. Those routes may be discovered by different dynamic routing protocols or static routes manually configured. The entry with the highest priority (smallest value) becomes the current best route. The user can configure several routes of different priority to the same destination; layer3 switch will choose one route for IP packet forwarding according to the priority order.

To prevent too large route table, a default route can be set. Once route table look up fails, the default route will be chosen for forwarding packets.

The table below describes the routing protocols supported by switch and the default route look up priority value.

Routing Protocols or route type	Default priority value
Direct route	0
OSPF	110
Static route	1
RIP	120
OSPF ASE	150
IBGP	200
EBGP	20
Unknown route	255

5.1.2 IP Routing Policy

5.1.2.1 Introduction to Routing Policy

Some policies have to be applied when the router publishing and receiving routing messages so to filter routing messages, such as only receiving or publishing routing messages meets the specified conditions. A routing protocol maybe need redistribute other routing messages found by other protocols such as OSPF so to increase its own routing knowledge; when the router redistributing routing messages from other routing protocols there may be only part of the qualified routing messages is needed, and some properties may have to be configured to suit this protocol.

To achieve routing policy, first we have to define the characteristics of the routing messages to be applied with routing policies, namely define a group matching rules. We can configure by different properties in the routing messages such as destination address, the router address publishing the routing messages. The matching rules can be previously configured to be applied in the routing publishing, receiving and distributing policies.

Five filters are provided in switch: route-map, acl, as-path, community-list and ip-prefix for use. We will introduce each filter in following sections:

1. route-map

For matching certain properties of the specified routing information and setting some routing properties when the conditions are fulfilled.

Route-map is for controlling and changing the routing messages while also controlling the redistribution among routes. A route-map consists of a series of match and set commands in which the match command specifies the conditions required matching, and the set command specifies the actions to be taken when matches. The route-map is also for controlling route publishing among different route process. It can also used on policy routing which select different routes for the messages other than the shortest route.

A group matches and set clauses make up a node. A route-map may consist of several nodes each of which is a unit for matching test. We match among nodes with by sequence-number. Match clauses define matching rules. The matching objects are some properties of routing messages. Different match clause in the same node is “and” relation logically, which means the matching test of a node, will not be passed until conditions in its entire match clause are matched. Set clause specifies actions, namely configure some properties of routing messages after the matching test is passed.

Different nodes in a route-map is an “or” relation logically. The system checks each node of the route-map in turn and once certain node test is passed the route-map test will be passed without taking the next node test.

2. access control list(acl)

ACL (Access Control Lists) is a data packet filter mechanism in the switch. The switch controls the network access and secure the network service by permitting or denying certain data packet transmtting out from or into the network. Users can establish a group of rules by certain messages in the packet, in which each rule to be applied on certain amount of matching messages: permit or deny. The users can apply these rules to the entrance or exit of specified switch, with which data stream in certain direction on certain port would have to follow the specified ACL rules in-and-out the switch. Please refer to chapter “ACL Configuration”.

3. Ip-prefix list

The ip-prefix list acts similarly to acl while more flexible and more understandable. The match object of ip-prefix is the destination address messages field of routing messages when applied in routing messages filtering.

An ip-prefix is identified by prefix list name. Each prefix list may contain multiple items, each of which specifies a matching range of a network prefix type and identifies with a sequence-number which specifies the matching check order of ip-prefix.

In the process of matching, the switch check each items identified by sequence-number in ascending order and the filter will be passed once certain items is matched(without checking rest items)

4. Autonomic system path information access-list as-path

The autonomic system path information access-list as-path is only used in BGP. In the BGP routing messages packet there is an autonomic system path field (in which autonomic system path the routing messages passes through is recorded). As-path is specially for specifying matching conditions for autonomic system path field.

As for relevant as-path configurations, please refer to the ip as-path command in BGP configuration.

5. community-list

Community-list is only for BGP. There is a community property field in the BGP routing messages packet for identifying a community. The community list is for specifying matching conditions for Community-list field.

As for relevant Community-list configuration, please refer to the ip as-path command in BGP configuration

5.1.2.2 IP Routing Policy Configuration Task List

1. Define route-map
2. Define the match clause in route-map
3. Define the set clause in route-map
4. Define address prefix list

1. Define route-map

Command	Explanation
Global mode	
<code>route-map <map_name> {deny permit} <sequence_num></code> <code>no route-map <map_name> [{deny permit} <sequence_num>]</code>	Configure route-map; the no route-map <map_name> [{deny permit} <sequence_num>] command deletes the route-map.

2. Define the match clause in route-map

Command	Explanation
Route-map configuration mode	

<pre>match as-path <list-name> no match as-path [<list-name>]</pre>	<p>Match the autonomous system as path access-list the BGP route passes through; the no match as-path [<list-name>] command deletes match condition.</p>
<pre>match community <community-list-name community-list-num > [exact-match] no match community [<community-list-name community-list-num > [exact-match]]</pre>	<p>Match a community property access-list. The no match community [<community-list-name community-list-num > [exact-match]] command deletes match condition.</p>
<pre>match interface <interface-name > no match interface [<interface-name >]</pre>	<p>Match by ports; The no match interface [<interface-name >] command deletes match condition.</p>
<pre>match ip <address next-hop> <ip-acl-name ip-acl-num prefix-list list-name> no match ip <address next-hop> [<ip-acl-name ip-acl-num prefix-list [list-name]>]</pre>	<p>Match the address or next-hop; The no match ip <address next-hop> [<ip-acl-name ip-acl-num prefix-list [list-name]>] command deletes match condition.</p>
<pre>match metric <metric-val > no match metric [<metric-val >]</pre>	<p>Match the routing metric value; The no match metric [<metric-val >] command deletes match condition.</p>
<pre>match origin <egp igp incomplete > no match origin [<egp igp incomplete >]</pre>	<p>Match the route origin; The no match origin [<egp igp incomplete >] command deletes match condition.</p>
<pre>match route-type external <type-1 type-2 > no match route-type external [<type-1 type-2 >]</pre>	<p>Match the route type; The no match route-type external [<type-1 type-2 >] command deletes match condition.</p>
<pre>match tag <tag-val > no match tag [<tag-val >]</pre>	<p>Match the route tag; The no match tag [<tag-val >] command deletes match condition.</p>

3. Define the set clause in route-map

Command	Explanation
Route-map configuration mode	
set aggregator as <as-number> <ip_addr> no set aggregator as [<as-number> <ip_addr>]	Distribute an AS No. for BGP aggregator; The no command deletes the configuration
set as-path prepend <as-num> no set as-path prepend [<as-num>]	Add a specified AS No. before the BGP routing messages as-path series; The no command deletes the configuration
set atomic-aggregate no set atomic-aggregate	Configure the BGP atomic aggregate property; The no command deletes the configuration
set comm-list <community-list-name <community-list-num> delete no set comm-list <community-list-name <community-list-num> delete	Delete BGP community list value; The no command deletes the configuration
set community [AA:NN] [internet] [local-AS] [no-advertise] [no-export] [none] [additive] no set community [AA:NN] [internet] [local-AS] [no-advertise] [no-export] [none] [additive]	Configure BGP community list value; The no command deletes the configuration
set extcommunity <rt soo> <AA:NN> no set extcommunity <rt soo> [<AA:NN>]	Configure BGP extended community list property; The no command deletes the configuration
set ip next-hop <ip_addr> no set ip next-hop [<ip_addr>]	Set next-hop IP address; The no command deletes the configuration
set local-preference <pre_val> no set local-preference [<pre_val>]	Set local preference; The no command deletes the configuration
set metric < +/- metric_val metric_val> no set metric [+/- metric_val metric_val]	Set routing metric value; The no command deletes the configuration
set metric-type <type-1 type-2> no set metric-type [<type-1 type-2>]	Set OSPF metric type; The no command deletes the configuration
set origin <egp igp incomplete > no set origin [<egp igp incomplete >]	Set BGP routing origin; The no command deletes the configuration
set originator-id <ip_addr>	Set routing originator ID;

no set originator-id [<ip_addr>]	The no command deletes the configuration
set tag <tag_val> no set tag [<tag_val>]	Set OSPF routing tag value; The no command deletes the configuration
set vpnv4 next-hop <ip_addr> no set vpnv4 next-hop [<ip_addr>]	Set BGP VPNv4 next-hop address; the no command deletes the configuration
set weight <weight_val> no set weight [<weight_val>]	Set BGP routing weight; The no command deletes the configuration

4. Define address prefix list

Command	Explanation
Global mode	
ip prefix-list <list_name> description <description> no ip prefix-list <list_name> description	Describe the prefix list; The no ip prefix-list <list_name> description command deletes the configuration.
ip prefix-list <list_name> [seq <sequence_number>] <deny permit> < any ip_addr/mask_length [ge min_prefix_len] [le max_prefix_len]> no ip prefix-list <list_name> [seq <sequence_number>] [<deny permit> < any ip_addr/mask_length [ge min_prefix_len] [le max_prefix_len]>]	Set the prefix list; The no ip prefix-list <list_name> [seq <sequence_number>] [<deny permit> < any ip_addr/mask_length [ge min_prefix_len] [le max_prefix_len]>] command deletes the configuration.

5.1.2.3 Configuration Examples

The figure below shows a network consisting of four Layer 3 switches. This example demonstrates how to set the BGP as-path properties through route-map. BGP protocol is applied among the Layer 3 switches. As for switchC, the network 192.68.11.0/24 can be reached through two paths in which one is AS-PATH 1 by IBGP (going through SwitchD), the other one is AS-PATH 2 by EBGp (going through SwitchB). BGP selects the shortest path, so AS-PATH 1 is the preferred path. If the path 2 is wished, which is through EBGp path, we can add two extra AS path numbers into the AS-PATH messages from SwitchA to SwitchD so as to change the determination SwitchC take to 192.68.11.0/24.

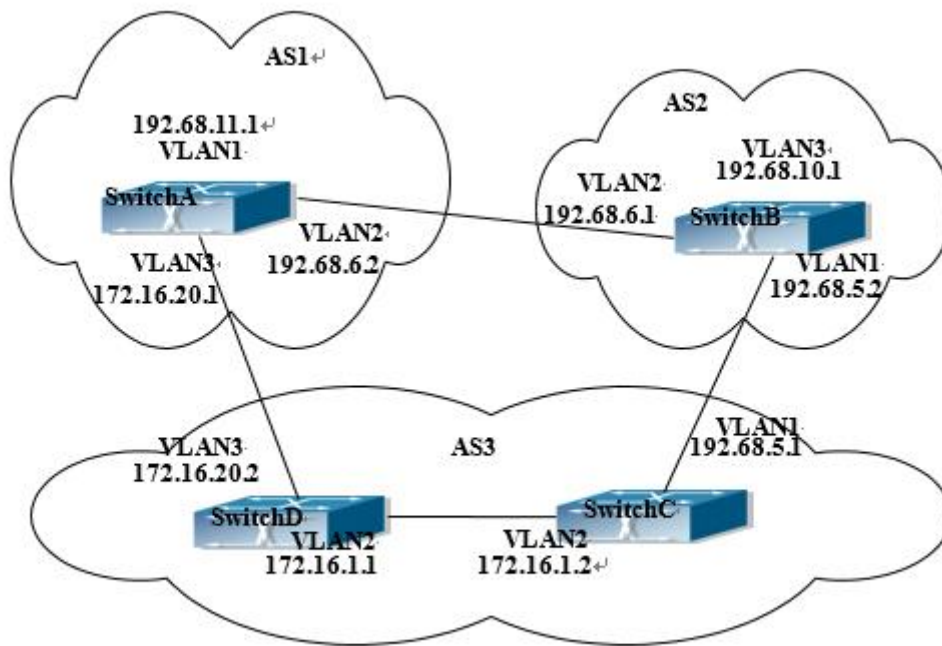

Figure 4- 1 Policy routing Configuration

Configuration procedure: (only SwitchA is listed, configurations for other switches are omitted.)

The configuration of Layer 3 switchA:

```
SwitchA#config
```

```
SwitchA(config)#router bgp 1
```

```
SwitchA(config-router)#network 192.68.11.0 mask 255.255.255.0
```

```
SwitchA(config-router)#neighbor 172.16.20.2 remote-as 3
```

```
SwitchA(config-router)#neighbor 172.16.20.2 route-map AddAsNumbers out
```

```
SwitchA(config-router)#neighbor 192.68.6.1 remote-as 2
```

```
SwitchA(config-router)#exit
```

```
SwitchA(config)#route-map AddAsNumbers permit 10
```

```
SwitchA(config-route-map)#set as-path prepend 1 1
```

5.1.2.4 Troubleshooting

Faq: The routing protocol could not achieve the routing messages study under normal protocol running state

Troubleshooting: check following errors:

- ☞ Each node of route-map should at least has one node is permit match mode. When the route map is used in routing messages filtering, the routing messages will be considered not pass the routing messages filtering if certain routing messages does not pass the filtering of any nodes. When all nodes are set to deny mode, all routing messages will not pass the filtering in this route-map.
- ☞ Items in address prefix list should at least have one item set to permit mode. The deny mode

items can be defined first to fast remove the unmatched routing messages, however if all the items are set to deny mode, any route will not be able to pass the filtering of this address prefix list. We can define a permit 0.0.0.0/0 le 32 item after several deny mode items are defined so to permit all other routing messages pass through. Only default route will be matched in less-equal 32 is not specified.

5.2 Static Route

5.2.1 Introduction to Static Route

As mentioned earlier, the static route is the manually specified path to a network or a host. Static route is simple and consistent, and can prevent illegal route modification, and is convenient for load balance and route backup. However, it also has its own defects. Static route, as its name indicates, is static, it won't modify the route automatically on network failure, and manual configuration is required on such occasions, therefore it is not suitable for mid and large-scale networks.

Static route is mainly used in the following two conditions: 1) in stable networks to reduce load of route selection and routing data streams. For example, static route can be used in route to STUB network. 2) For route backup, configure static route in the backup line, with a lower priority than the main line.

Static route and dynamic route can coexist; layer3 switch will choose the route with the highest priority according to the priority of routing protocols. At the same time, static route can be introduced (redistribute) in dynamic route, and change the priority of the static route introduced as required.

5.2.2 Introduction to Default Route

Default route is a kind of static route, which is used only when no matching route is found. In the route table, default route is indicated by a destination address of 0.0.0.0 and a network mask of 0.0.0.0, too. If the route table does not have the destination of a packet and has no default route configured, the packet will be discarded, and an ICMP packet will be sent to the source address indicate the destination address or network is unreachable.

5.2.3 Static Route Configuration Task List

1. Static route configuration
2. VRF configuration

1. Static route configuration

Command	Explanation
Global mode	
ip route {<ip-prefix> <mask> <ip-prefix>/<prefix-length>} {<gateway-address> <gateway-interface>} [<distance>]	Set static routing; the no ip route {<ip-prefix> <mask> <ip-prefix>/<prefix-length>} {<gateway-address> <gateway-interface>} [<distance>] command deletes a static route entry
no ip route {<ip-prefix> <mask> <ip-prefix>/<prefix-length>} {<gateway-address> <gateway-interface>} [<distance>]	

2. VRF configuration

Command	Explanation
Global mode	
ip route vrf <name> {<ip-prefix> <mask> <ip-prefix/>prefix-length>} {<gateway-address> <gateway-interface>} [<distance>]	Configure the static route, the no command will delete the static route.
no ip route vrf <name> {<ip-prefix> <mask> <ip-prefix/>prefix-length>} {<gateway-address> <gateway-interface>} [<distance>]	

5.2.4 Static Route Configuration Examples

The figure shown below is a simple network consisting of three layer3 switches, the network mask for all switches and PC is 255.255.255.0. PC-A and PC-C are connected via the static route set in SwitchA and SwitchC; PC3 and PC-B are connected via the static route set in SwitchC to SwitchB; PC-B and PC-C is connected via the default route set in SwitchB.

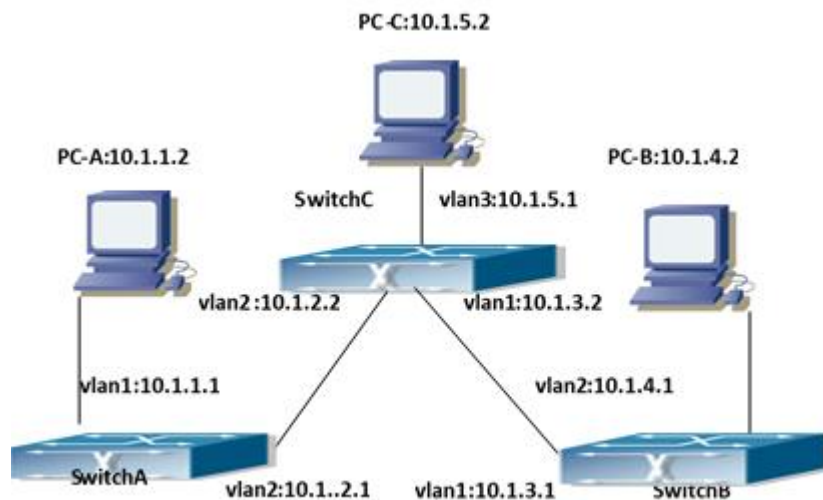

Figure 4-2 Static Route Configurations

Configuration steps:

Configuration of layer3 SwitchA

```
Switch#config
```

```
Switch (config) #ip route 10.1.5.0 255.255.255.0 10.1.2.2
```

Configuration of layer3 SwitchC

```
Switch#config
```

Next hop use the partner IP address

```
Switch(config)#ip route 10.1.1.0 255.255.255.0 10.1.2.1
```

Next hop use the partner IP address

```
Switch(config)#ip route 10.1.4.0 255.255.255.0 10.1.3.1
```

Configuration of layer3 SwitchB

```
Switch#config
```

```
Switch(config)#ip route 0.0.0.0 0.0.0.0 10.1.3.2
```

In this way, ping connectivity can be established between PC-A and PC-C, and PC-B and PC-C.

5.3 RIP

5.3.1 Introduction to RIP

RIP is first introduced in ARPANET, this is a protocol dedicated to small, simple networks. RIP is a distance vector routing protocol based on the Bellman-Ford algorithm. Network devices running vector routing protocol send two kind of information to the neighboring devices regularly:

- Number of hops to reach the destination network, or metrics to use or number of networks to pass.
- What is the next hop, or the director (vector) to use to reach the destination network.

The distance vector Layer 3 switch send all their route selecting tables to the neighbor layer3 switches at regular interval. A layer3 switch will build their own route selecting information table based on the information received from the neighbor layer3 switches. Then, it will send this information to its own neighbor layer3 switches. As a result, the route selection table is built on second hand information, route beyond 15 hops will be deemed as unreachable.

RIP protocol is an optional routing protocol based on UDP. Hosts using RIP send and receive packets on UDP port 520. All layer3 switches running RIP send their route table to all neighbor layer3 switches every 30 seconds for update. If no information from the partner is received in 180 seconds, then the device is deemed to have failed and the network connected to that device is considered to be unreachable. However, the route of that layer3 switch will be kept in the route table for another 120 seconds before deletion.

As layer3 switches running RIP built route table with second hand information, infinite count may occur. For a network running RIP routing protocol, when an RIP route becomes unreachable, the neighboring RIP layer3 switch will not send route update packets at once, instead, it waits until the update interval timeout (every 30 seconds) and sends the update packets containing that route. If before it receives the updated packet, its neighbors send packets containing the information

about the failed neighbor, “infinite count” will be resulted. In other words, the route of unreachable layer3 switch will be selected with the metrics increasing progressively. This greatly affects the route selection and route aggregation time.

To prevent “infinite count”, RIP provides mechanism such as “split horizon” and “triggered update” to solve route loop. “Split horizon” is done by avoiding sending to a gateway routes learned from that gateway. There are two split horizon methods: “simple split horizon” and “poison reverse split horizon”. Simple split horizon deletes from the route to be sent to the neighbor gateways the routes learnt from the neighbor gateways; poison reverse split horizon not only deletes the abovementioned routes, but set the costs of those routes to infinite. “Triggering update” mechanism defines whenever route metric changed by the gateway, the gateway advertise the update packets immediately, regardless of the 30 second update timer status.

There two versions of RIP, version 1 and version 2. RFC1058 introduces RIP-I protocol, RFC2453 introduces RIP-II, which is compatible with RFC1723 and RFC1388. RIP-I updates packets by packets broadcast, subnet mask and authentication is not supported. Some fields in the RIP-I packets are not used and are required to be all 0's; for this reason, such all 0's fields should be checked when using RIP-I, the RIP-I packets should be discarded if such fields are non-zero. RIP-II is a more improved version than RIP-I. RIP-II sends route update packets by multicast packets (multicast address is 224.0.0.9). Subnet mask field and RIP authentication filed (simple plaintext password and MD5 password authentication are supported), and support variable length subnet mask. RIP-II used some of the zero field of RIP-I and require no zero field verification. switch send RIP-II packets in multicast by default, both RIP-I and RIP-II packets will be accepted.

Each layer3 switch running RIP has a route database, which contains all route entries for reachable destination, and route table is built based on this database. When a RIP layer3 switch sent route update packets to its neighbor devices, the complete route table is included in the packets. Therefore, in a large network, routing data to be transferred and processed for each layer3 switch is quite large, causing degraded network performance.

Besides the above mentioned, RIP protocol allows route information discovered by the other routing protocols to be introduced to the route table. It can also be as the protocol exchanging route messages with CE on PE routers, and supports the VPN route/transmitting examples.

The operation of RIP protocol is shown below:

1. Enable RIP. The switch sends request packets to the neighbor layer3 switches by broadcasting; on receiving the request, the neighbor devices reply with the packets containing their local routing information.
2. The Layer3 switch modifies its local route table on receiving the reply packets and sends triggered update packets to the neighbor devices to advertise route update information. On receiving the triggered update packet, the neighbor lay3 switches send triggered update packets to their neighbor lay3 switches. After a sequence of triggered update packet broadcast, all layer3 switches get and maintain the latest route information.

In addition, RIP layer3 switches will advertise its local route table to their neighbor devices every 30 seconds. On receiving the packets, neighbor devices maintain their local route table, select the best route and advertise the updated information to their own neighbor devices, so that the updated routes are globally valid. Moreover, RIP uses a timeout mechanism for outdated route,

that is, if a switch does not receive regular update packets from a neighbor within a certain interval (invalid timer interval), it considers the route from that neighbor invalid, after holding the route for a certain interval (holddown timer interval), it will delete that route.

5.3.2 RIP Configuration Task List

1. Enable RIP (required)
 - (1) Enable/disable RIP module.
 - (2) Enable interface to send/receive RIP packets
2. Configure RIP protocol parameters (optional)
 - (1) Configure RIP sending mechanism
 - 1) Configure specified RIP packets transmission address
 - 2) Configure RIP interface broadcast
 - (2) Configure the RIP routing parameters
 - 1) Configure route introduction (default route metric, configure routes of the other protocols to be introduced in RIP)
 - 2) Configure interface authentication mode and password
 - 3) Configure the route deviation
 - 4) Configure and apply route filter
 - 5) Configure Split Horizon
 - (3) Configure other RIP protocol parameters
 - 1) Configure the managing distance of RIP route
 - 2) Configure the RIP route capacity limit in route table
 - 3) Configure the RIP update, timeout, holddown and other timer.
 - 4) Configure the receiving buffer size of RIP UDP
3. Configure RIP-I/RIP-II switch
 - (1) Configure the RIP version to be used in all interfaces
 - (2) Configure the RIP version to send/receive in all interfaces
 - (3) Configure whether to enable RIP packets sending/receiving for interfaces
4. Delete the specified route in RIP route table
5. Configure the RIP routing aggregation
 - (1) Configure aggregation route of IPv4 route mode
 - (2) Configure aggregation route of IPv4 interface configuration mode
 - (3) Display IPv4 aggregation route information
6. Configure redistribution of OSPF routing to RIP
 - (1) Enable Redistribution of OSPF routing to RIP
 - (2) Display and debug the information about configuration of redistribution of OSPF routing to RIP
7. Configure VRF address family mode for RIP
 - (1) Enable/disable RIP module
 - (2) Configure VRF address family

1. Enable RIP protocol

Applying RIP route protocol with basic configuration in switch is simple. Normally you only have to open the RIP switch and configure the segments running RIP, namely send and receive the RIP data packet by default RIP configuration. The version of data packet sending and receiving is variable when needed, allow/deny sending, receiving RIP data packet. Refer to 3.

Command	Explanation
Global Mode	
router rip no router rip	Enables RIP; the no router rip command disables RIP.
Router and address family configuration mode	
network <A.B.C.D/M ifname vlan> no network <A.B.C.D/M ifname vlan>	Enables the segment running RIP protocol; the no network <A.B.C.D/M ifname vlan> command deletes the segment.

2. Configure RIP protocol parameters

(1) Configure RIP packet transmitting mechanism

- 1) Configure the RIP data packet point-transmitting
- 2) Configure the Rip broadcast

Command	Explanation
Router Configuration Mode	
neighbor <A.B.C.D> no neighbor <A.B.C.D>	Specify the IP address of the neighbor router needs point-transmitting; the no neighbor <A.B.C.D> command cancels the appointed router.
passive-interface<ifname vlan> no passive-interface<ifname vlan >	Block the RIP broadcast on specified port and the RIP data packet is only transmittable among Layer 3 switch configured with neighbor. The no passive-interface<ifname vlan > command cancels the function.

(2) Configure RIP route parameters

- 1) Configure route introduction (default route metric, configure routes of the other protocols to be introduced in RIP)

Command	Explanation
Router Configuration Mode	
default-metric <value> no default-metric	Sets the default route metric for route to be introduced; the no default-metric command restores the default setting.
redistribute {kernel connected static ospf isis bgp} [metric<value>] [route-map<word>] no redistribute {kernel connected static ospf isis bgp} [metric<value>] [route-map<word>]	Redistribute the routes distributed in other routing protocols into the RIP data packet; the no redistribute {kernel connected static ospf isis bgp} [metric<value>] [route-map<word>] command cancels the distributed route of corresponding protocols.

default-information originate no default-information originate	Generate a default route to the RIP protocol; the no default-information originate command cancels the feature.
---	--

2) Configure interface authentication mode and password

Command	Explanation
Interface configuration mode	
ip rip authentication mode { text md5} no ip rip authentication mode [text md5]	Sets the authentication method; the no ip rip authentication mode [text md5] command cancels the authentication action.
ip rip authentication string <text> no ip rip authentication string	Sets the authentication key; the no ip rip authentication string command means no key is needed.
ip rip authentication key-chain <name-of-chain> no ip rip authentication key-chain [<name-of-chain>]	Sets the key chain used in authentication, the no ip rip authentication key-chain [<name-of-chain>] command means the key chain is not used.
ip rip authentication cisco-compatible no ip rip authentication cisco-compatible	After configure this command, configure MD5 authentication, then can receive RIP packet of Cisco, the no command restores the default configuration.
Global mode	
key chain <name-of-chain> no key chain < name-of-chain >	Enter keychain mode, and configure a key chain, the no key chain < name-of-chain > command deletes the key chain.
Keychain mode	
key <keyid> no key <keyid>	Enter the keychain-key mode and configure a key of the keychain; the no key <keyid> command deletes one key.
Keychain-key mode	
key-string <text> no key-string <text>	Configure the password used by the key, the no key-string <text> command deletes the password.
accept-lifetime <start-time> {<end-time> duration<seconds> infinite} no accept-lifetime	Configure a key on the key chain and accept it as an authorized time; the no accept-lifetime command deletes it.
send-lifetime <start-time> {<end-time> duration<seconds> infinite} no send-lifetime	Configure the transmitting period of a key on the key chain; the no send-lifetime command deletes the send-lifetime.

3) Configure the route deviation

Command	Explanation
Router configuration mode	

offset-list <access-list-number access-list-name> {in out } <number> [<ifname>] no offset-list <access-list-number access-list-name> {in out }<number >[<ifname>]	Configure that provide a deviation value to the route metric value when the port sends or receives RIP data packet; the no offset-list <access-list-number access-list-name> {in out } <number >[<ifname>] command removes the deviation table.
---	---

4) Configure and apply the route filtering

Command	Explanation
Router configuration mode	
distribute-list {< access-list-number access-list-name > prefix<prefix-list-name >}{in out} [<ifname>] no distribute-list {< access-list-number access-list-name > prefix<prefix-list-name >}{in out} [<ifname>]	Configure and apply the access table and prefix table to filter the routes. The no distribute-list {< access-list-number access-list-name> prefix<prefix-list-name>}{in out} [<ifname>] command means do not use the access table and prefix table.

5) Configure the split horizon

Command	Explanation
Interface configuration mode	
ip rip split-horizon [poisoned] no ip rip split-horizon	Configure that take the split horizon when the port sends data packets; poisoned for poison reverse the no ip rip split-horizon command cancels the split horizon.

(3) Configure other RIP protocol parameters

- 1) Configure RIP routing priority
- 2) Configure the RIP route capacity limit in route table
- 3) Configure timer for RIP update, timeout and hold-down
- 4) Configure RIP UDP receiving buffer size

Command	Explanation
Router configuration mode	
distance <number> [<A.B.C.D/M>] [<access-list-name access-list-number >] no distance [<A.B.C.D/M>]	Specify the route administratively distance of RIP protocol; the no distance [<A.B.C.D/M>] command restores the default value 120.
maximum-prefix <maximum-prefix>[<threshold>] no maximum-prefix <maximum-prefix > no maximum-prefix	Configure the maximum of RIP route; the no maximum-prefix <maximum-prefix > no maximum-prefix command cancels the limit.
timers basic <update> <invalid> <garbage> no timers basic	Adjust the update, timeout and garbage collection time, the no timers basic command restores the default configuration.
recv-buffer-size <size> no recv-buffer-size	The command configures the UDP receiving buffer size of the RIP; the no recv-buffer-size

	command restores the system default values.
--	---

3. Configure RIP-I/RIP-II toggling

(1) Configure the RIP version to be used in all ports

Command	Explanation
RIP configuration mode	
version { 1 2 } no version	Configure the versions of all the RIP data packets transmitted/received by the Layer 3 switch port sending/receiving the no version command restores the default configuration, version 2.

(2) Configure the RIP version to send/receive in all ports.

(3) Configure whether to enable RIP packets sending/receiving for ports

Command	Explanation
Interface configuration mode	
ip rip send version { 1 1-compatible 2 } no ip rip send version	Sets the version of RIP packets to send on all ports; the no ip rip send version command set the version to the one configured by the version command.
ip rip receive version {1 2 } no ip rip receive version	Sets the version of RIP packets to receive on all ports; the no action of this command set the version to the one configured by the version command.
ip rip receive-packet no ip rip receive-packet	Enables receiving RIP packets on the interface; the no ip rip receive-packet command close data receiving on this port.
ip rip send-packet no ip rip send-packet	Enables sending RIP packets on the interface; the no ip rip send-packet command disables sending RIP packets on the interface.

4. Delete the specified route in RIP route table

Command	Explanation
Admin Mode	
clear ip rip route {<A.B.C.D/M> kernel static connected rip ospf isis bgp all}	The command deletes a specified route from the RIP route table.

5. Configure the RIP routing aggregation

(1) Configure IPv4 aggregation route globally

Command	Explanation
Router Configuration Mode	
ip rip aggregate-address A.B.C.D/M no ip rip aggregate-address A.B.C.D/M	To configure or delete IPv4 aggregation route globally.

(2) Configure IPv4 aggregation route on interface

Command	Explanation

Interface Configuration Mode	
ip rip aggregate-address A.B.C.D/M no ip rip aggregate-address A.B.C.D/M	To configure or delete IPv4 aggregation route on interface.

(3) Display IPv4 aggregation route information

Command	Explanation
Admin Mode and Configuration Mode	
show ip rip aggregate	To display aggregation route information.

6. Configure redistribution of OSPF routing to RIP

(1) Enable Redistribution of OSPF routing to RIP

Command	Explanation
Router RIP Configuration Mode	
redistribute ospf [<process-id>] [metric <value>] [route-map <word>] no redistribute ospf [<process-id>]	To enable or disable the redistribution of OSPF routing to RIP.

(2) Display and debug the information about configuration of redistribution of OSPF routing to RIP

Command	Explanation
Admin Mode and Configuration Mode	
show ip rip redistribute	To display the information about configuration of redistribute from other routing.
Admin Mode	
debug rip redistribute message send no debug rip redistribute message send debug rip redistribute route receive no debug rip redistribute route receive	To enable or disable debugging messages sent by RIP for redistribution of OSPF routing. To enable or disable debugging messages received from NSM.

7. Configure VRF address family mode for RIP

Command	Explanation
Router RIP configuration mode	
address-family ipv4 vrf <vrf-name> no address-family ipv4 vrf <vrf-name>	The command configures a RIP address family on the VRF of the PE router; the no command deletes the configured address family.
Address family configuration mode	
exit-address-family	This command exits the address family mode.

5.3.3 RIP Examples

5.3.3.1 Typical RIP Examples

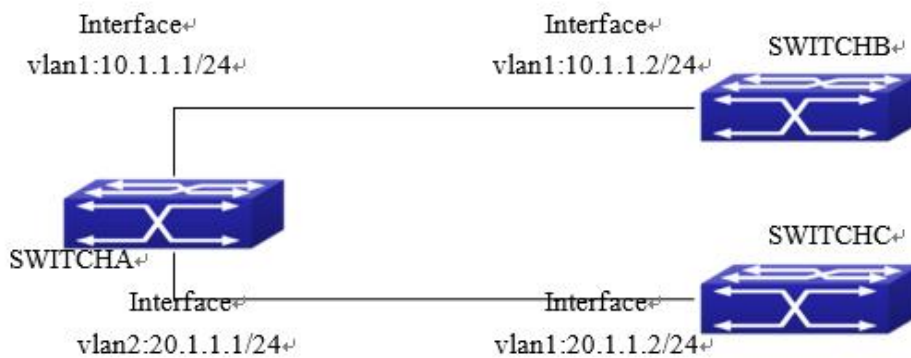

Figure 4-3 RIP example

In the figure shown above, a network consists of three Layer 3 switches, in which SwitchA connected with SwitchB and SwitchC, and RIP routing protocol is running in all of the three switches. SwitchA (interface vlan1: 10.1.1.1, interface vlan2: 20.1.1.1) exchanges Layer 3 switch update messages only with SwitchB (interface vlan1: 10.1.1.2), but not with SwitchC (interface vlan 2: 20.1.1.2).

SwitchA, SwitchB, SwitchC configurations are as follows:

a) Layer 3 SwitchA:

Configure the IP address of interface vlan 1

```
SwitchA#config
```

```
SwitchA(config)# interface vlan 1
```

```
SwitchA(Config-if-Vlan1)# ip address 10.1.1.1 255.255.255.0
```

```
SwitchA(config-if-Vlan1)#
```

Configure the IP address of interface vlan 2

```
SwitchA(config)# vlan 2
```

```
SwitchA(Config-Vlan2)# switchport interface ethernet 1/0/2
```

Set the port Ethernet1/0/2 access vlan 2 successfully

```
SwitchA(Config-Vlan2)# exit
```

```
SwitchA(config)# interface vlan 2
```

```
SwitchA(Config-if-Vlan2)# ip address 20.1.1.1 255.255.255.0
```

Initiate RIP protocol and configure the RIP segments

```
SwitchA(config)#router rip
```

```
SwitchA(config-router)#network vlan 1
```

```
SwitchA(config-router)#network vlan 2
```

```
SwitchA(config-router)#exit
```

Configure that the interface vlan 2 do not transmit RIP messages to SwitchC

```
SwitchA(config)#router rip
```

```
SwitchA(config-router)#passive-interface vlan 2
```

```
SwitchA(config-router)#exit
```

```
SwitchA(config) #
```

b) Layer 3 SwitchB

Configure the IP address of interface vlan 1

```
SwitchB#config
```



```

SwitchB(config)# interface vlan 1
SwitchB(Config-if-Vlan1)# ip address 10.1.1.2 255.255.255.0
SwitchB(Config-if-Vlan1)# exit
Initiate RIP protocol and configure the RIP segments
SwitchB(config)#router rip
SwitchB(config-router)#network vlan 1
SwitchB(config-router)#exit

```

c) Layer 3 SwitchC

```

SwitchC#config
SwitchC(config)# interface vlan 1
Configure the IP address of interface vlan 1
SwitchC(Config-if-Vlan1)# ip address 20.1.1.2 255.255.255.0
SwitchC(Config-if-Vlan1)#exit
Initiate RIP protocol and configure the RIP segments
SwitchC(config)#router rip
SwitchC(config-router)#network vlan 1
SwitchC(config-router)#exit

```

5.3.3.2 Typical Examples of RIP aggregation function

The application topology as follows:

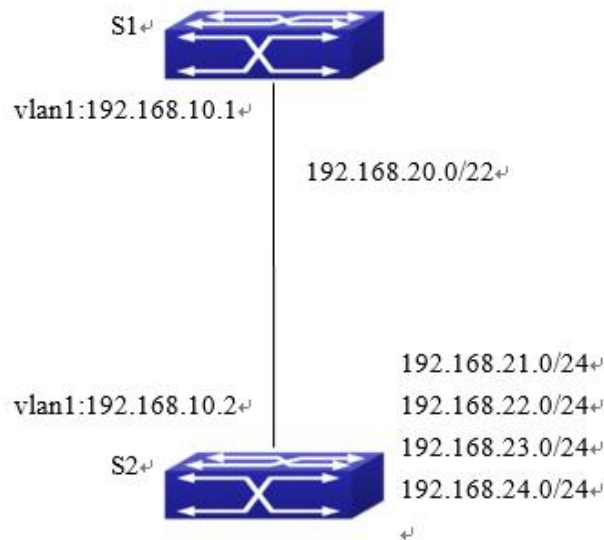

Figure 4-4 Typical application of RIP aggregation

As the above network topology, S2 is connected to S1 through interface vlan1, there are other 4 subnet routers of S2, which are 192.168.21.0/24, 192.168.22.0/24, 192.168.23.0/24, 192.168.24.0/24. S2 supports route aggregation, and to configure aggregation route 192.168.20.0/22 in interface vlan1 of S2, after that, sending router messages to S1 through vlan1, and put the four subnet routers aggregated to one router as 192.168.20.0/22, and send to S1, and not send subnet to neighbor. It can reduce the router table of S1, save the memory.

S1 configuration list:

```
S1(config)#router rip
S1(config-router) #network vlan 1
S2 configuration list:
S2(config)#router rip
S2(config-router) #network vlan 1
S2(config-router) #exit
S2(config)#in vlan 1
S2(Config-if-Vlan1)# ip rip agg 192.168.20.0/22
```

5.3.4 RIP Troubleshooting

The RIP protocol may not be working properly due to errors such as physical connection, configuration error when configuring and using the RIP protocol. So users should pay attention to following:

- 👉 First ensure the physic connection is correct
- 👉 Second, ensure the interface and chain protocol are UP (use **show interface** command)
- 👉 Then initiate the RIP protocol (use **router rip** command) and configure the segment (use **network** command) and set RIP protocol parameter on corresponding interfaces, such as the option between RIP-I and RIP-II
- 👉 After that, one feature of RIP protocol should be noticed ---the Layer 3 switch running RIP protocol sending route updating messages to all neighboring Layer 3 switches every 30 seconds. A Layer 3 switch is considered inaccessible if no route updating messages from the switch is received within 180 seconds, then the route to the switch will remains in the route table for 120 seconds before it is deleted. Therefore, if to delete a RIP route, this route item is assured to be deleted from route table after 300 seconds.
- 👉 When exchanging routing messages with CE using RIP protocol on the PE router, we should first create corresponding VPN routing/transmitting examples to associate with corresponding interfaces. Then enter the RIP address family mode configuring corresponding parameters. If the RIP routing problem remains unresolved, please use debug rip command to record the debug message in three minutes, and send them to our technical service center.

5.4 OSPF

5.4.1 Introduction to OSPF

OSPF is abbreviation for Open Shortest Path First. It is an interior dynamic routing protocol

for autonomous system based on link-state. The protocol creates a link-state database by exchanging link-states among layer3 switches, and then uses the Shortest Path First algorithm to generate a route table basing on that database.

Autonomous system (AS) is a self-managed interconnected network. In large networks, such as the Internet, a giant interconnected network is broken down to autonomous systems. Big enterprise networks connecting to the Internet are independent AS, since the other hosts on the Internet are not managed by those AS and they don't share interior routing information with the layer3 switches on the Internet.

Each link-state Layer3 switch can provide information about the topology with its neighboring Layer3 switches.

- The network segment (link) connecting to the layer3 switch
- State of the connecting link

Link-state information is flooded throughout the network so that all Layer3 switches can get firsthand information. Link-state Layer3 switches will not broadcast all information contained in their route tables; instead, they only send changed link-state information. Link-state Layer3 switches establish neighborhood by sending "HELLO" to their neighbors, then link-state advertisements (LSA) will be sent among neighboring Layer3 switches. Neighboring Layer3 switch copy the LSA to their routing table and transfer the information to the rest part of the network. This process is referred to as "flooding". In this way, firsthand information is sent throughout the network to provide accurate map for creating and updating routes in the network. Link-state routing protocols use cost instead of hops to decide the route. Cost is assigned automatically or manually. According to the algorithm in link-state protocol, cost can be used to calculate the hop number for packets to pass, link bandwidth, and current load of the link. The administrator can even add weight for better assessment of the link-state.

1) When a link-state layer3 switch enters a link-state interconnected network, it sends a HELLO packet to get to know its neighbors and establish neighborhood.

2) The neighbors respond with information about the links they are connecting and the related costs.

3) The originate layer3 switch uses this information to build its own routing table

4) Then, as part of the regular update, layer3 switch send link-state advertisement (LSA) packets to its neighboring layer3 switches. The LSA include links and related costs of that layer3 switch.

5) Each neighboring layer3 switch copies the LSA packet and passes it to the next neighbor (i.e. flooding).

6) Since routing database is not recalculated before layer3 switch forwards LSA flooding, the converging time is greatly reduced.

One major advantage of link-state routing protocols is the fact that infinite counting is impossible, this is because of the way link-state routing protocols build up their routing table. The second advantage is that converging in a link-state interconnected network is very fast, once the routing topology changes, updates will be flooded throughout the network very soon. Those advantages release some layer3 switch resources, as the process ability and bandwidth used by bad route information are minor.

The features of OSPF protocol include the following: OSPF supports networks of various scales, several hundreds of layer3 switches can be supported in an OSPF network. Routing

topology changes can be quickly found and updating LSAs can be sent immediately, so that routes converge quickly. Link-state information is used in shortest path algorithm for route calculation, eliminating loop route. OSPF divides the autonomous system into areas, reducing database size, bandwidth occupation and calculation load. (According to the position of layer3 switches in the autonomous system, they can be grouped as internal area switches, area border switches, AS border switches and backbone switches). OSPF supports load balance and multiple routes to the same destination of equal costs. OSPF supports 4 level routing mechanisms (process routing according to the order of intra-area path, inter-area path, type 1 external path and type 2 external path). OSPF supports IP subnet and redistribution of routes from the other routing protocols, and interface-based packet verification. OSPF supports sending packets in multicast.

Each OSPF layer3 switch maintains a database describing the topology of the whole autonomous system. Each layer3 switch gathers the local status information, such as available interface, reachable neighbors, and sends link-state advertisement (sending out link-state information) to exchange link-state information with other OSPF layer3 switches to form a link-state database describing the whole autonomous system. Each layer3 switch builds a shortest path tree rooted by itself according to the link-state database, this tree provides the routes to all nodes in an autonomous system. If two or more layer3 switches exist (i.e. multi-access network), "designated layer3 switch" and "backup designated layer3 switch" will be selected. Designated layer3 switch is responsible for spreading link-state of the network. This concept helps reducing the traffic among the Layer3 switches in multi-access network.

OSPF protocol requires the autonomous system to be divided into areas. That is to divide the autonomous system into 0 area (backbone area) and non-0 areas. Routing information between areas are further abstracted and summarized to reduce the bandwidth required in the network. OSPF uses four different kinds of routes; they are intra-area route, inter-area route, type 1 external route and type 2 external route, in the order of highest priority to lowest. The route inside an area and between areas describes the internal network structure of an autonomous system, while external routes describe how to select the routing information to destination outside the autonomous system. The first type of exterior route corresponds to the information introduced by OSPF from the other interior routing protocols, the costs of those routes are comparable with the costs of OSPF routes; the second type of exterior route corresponds to the information introduced by OSPF from the other exterior routing protocols, but the costs of those routes are far greater than that of OSPF routes, so OSPF route cost is ignored when calculating route costs.

OSPF areas are centered with the Backbone area, identified as Area 0, all the other areas must be connected to Area 0 logically, and Area 0 must be continuous. For this reason, the concept of virtual link is introduced to the backbone area, so that physically separated areas still have logical connectivity to the backbone area. The configurations of all the layer3 switches in the same area must be the same.

In conclusion, LSA can only be transferred between neighboring Layer3 switches, OSPF protocol includes 5 types of LSA: router LSA, network LSA, network summary LSA to the other areas, ASBR summary LSA and AS external LSA. They can also be called type1 LSA, type2 LSA, type3 LSA, type4 LSA, and type5 LSA. Router LSA is generated by each layer3 switch inside an OSPF area, and is sent to all the other neighboring layer3 switches in the same area; network LSA is generated by the designated layer3 switch in the OSPF area of multi-access network, and is sent to all other neighboring layer3 switches in this area. (In order to reduce traffic on layer3 switches

in the multi-access network, “designated layer3 switch” and “backup designated layer3 switch” should be selected in the multi-access network, and the network link-state is broadcasted by the designated layer3 switch); network summary LSA is generated by border switches in an OSPF area, and is transferred among area border layer3 switches; AS external LSA is generated by layer3 switches on external border of AS, and is transferred throughout the AS.

As to autonomous systems mainly advertises exterior link-state, OSPF allow some areas to be configured as STUB areas to reduce the size of the topology database. Type4 LSA (ASBR summary LSA) and type5 LSA (AS external LSA) are not allowed to flood into/through STUB areas. STUB areas must use the default routes, the layer3 switches on STUB area edge advertise the default routes to STUB areas by type 3 summary LSA, those default routes only floods inside STUB area and will not get out of STUB area. Each STUB area has a corresponding default route, the route from a STUB area to AS exterior destination must rely on the default route of that area.

The following simply outlines the route calculation process of OSPF protocol:

- 1) Each OSPF-enabled layer3 switch maintains a database (LS database) describing the link-state of the topology structure of the whole autonomous system. Each layer3 switch generates a link-state advertisement according to its surrounding network topology structure (router LSA), and sends the LSA to other layer3 switches through link-state update (LSU) packets. Thus each layer3 switches receives LSAs from other layer3 switches, and all LSAs are combined to the link-state database.
- 2) Since a LSA is the description of the network topology structure around a layer3 switch, the LS database is the description of the network topology structure of the whole network. The layer3 switches can easily create a weighted vector map according to the LS database. Obviously, all layer3 switches in the same autonomous system will have the same network topology map.
- 3) Each layer3 switch uses the shortest path first (SPF) algorithm to calculate a tree of shortest path rooted by itself. The tree provides the route to all the nodes in the autonomous system, leaf nodes consist of the exterior route information. The exterior route can be marked by the layer3 switch broadcast it, so that additional information about the autonomous system can be recorded. As a result, the route table of each layer3 switch is different.

OSPF protocol is developed by the IETF; the OSPF v2 widely used now is fulfilled according to the content described in RFC2328.

5.4.2 OSPF Configuration Task List

The OSPF configuration may be different from the configuration procedure to switches of the other manufacturers. It is a two-step process:

1、 Enable OSPF in the Global Mode; 2 、 Configure OSPF area for the interfaces. The configuration task list is as follows:

1. Enable OSPF protocol (required)

- (1) Enable/disable OSPF protocol (required)
 - (2) Configure the ID number of the layer3 switch running OSPF (optional)
 - (3) Configure the network scope for running OSPF (optional)
 - (4) Configure the area for the interface (required)
2. Configure OSPF protocol parameters (optional)
- (1) Configure OSPF packet sending mechanism parameters
 - 1) Configure OSPF packet verification
 - 2) Set the OSPF interface to receive only
 - 3) Configure the cost for sending packets from the interface
 - 4) Configure OSPF packet sending timer parameter (timer of broadcast interface sending HELLO packet to poll, timer of neighboring layer3 switch invalid timeout, timer of LSA transmission delay and timer of LSA retransmission.
 - (2) Configure OSPF route introduction parameters
 - 1) Configure default parameters (default type, default tag value, default cost)
 - 2) Configure the routes of the other protocols to introduce to OSPF.
 - (3) Configure OSPF importing the routes of other OSPF processes
 - 1) Enable the function of OSPF importing the routes of other OSPF processes
 - 2) Display relative information
 - 3) Debug
 - (4) Configure other OSPF protocol parameters
 - 1) Configure OSPF routing protocol priority
 - 2) Configure cost for OSPF STUB area and default route
 - 3) Configure OSPF virtual link
 - 4) Configure the priority of the interface when electing designated layer3 switch (DR).
 - 5) Configure to keep a log for OSPF adjacency changes or not
 - 6) Filter the route obtained by OSPF
3. Disable OSPF protocol

1. Enable OSPF protocol

Basic configuration of OSPF routing protocol on switch is quite simple, usually only enabling OSPF and configuration of the OSPF area for the interface are required. The OSPF protocol parameters can use the default settings. If OSPF protocol parameters need to be modified, please refer to “2. Configure OSPF protocol parameters”.

Command	Explanation
Global Mode	
[no] router ospf [process <id>] [VRF Name]	Enables OSPF protocol; the no command disables OSPF protocol. (required)
OSPF Protocol Configuration Mode	

router-id <router_id> no router-id	Configures the ID number for the layer3 switch running OSPF; the no router id command cancels the ID number. The IP address of an interface is selected to be the layer3 switch ID. (optional)
[no] network {<network> <mask> <network>/<prefix>} area <area_id>	Configure certain segment to certain area, the no network {<network> <mask> <network>/<prefix>} area <area_id> command cancels this configuration. (required)

2. Configure OSPF protocol parameters

(1) Configure OSPF packet sending mechanism parameters

- 1) Configure OSPF packet verification
- 2) Set the OSPF interface to receive only
- 3) Configure the cost for sending packets from the interface

Command	Explanation
Interface Configuration Mode	
ip ospf authentication { message-digest null} no ip ospf authentication	Configures the authentication method by the interface to accept OSPF packets; the no ip ospf authentication command restores the default settings.
ip ospf [<ip-address>] authentication-key <0 LINE 7 WORD LINE> no ip ospf [<ip-address>] authentication	Specify the authentication key required in sending and receiving OSPF packet on the interface; the no command cancels the authentication key.
[no] passive-interface <ifname> [<ip-address>]	Sets an interface to receive only, the no passive-interface <ifname>[<ip-address>] command cancels this configuration.
ip ospf cost <cost > no ip ospf cost	Sets the cost for running OSPF on the interface; the no ip ospf cost command restores the default setting.

4) Configure OSPF packet sending timer parameter (timer of broadcast interface sending HELLO packet to poll, timer of neighboring layer3 switch invalid timeout, timer of LSA transmission delay and timer of LSA retransmission).

Command	Explanation
Interface Configuration Mode	
ip ospf hello-interval <time> no ip ospf hello-interval	Sets interval for sending HELLO packets; the no ip ospf hello-interval command restores the default setting.
ip ospf dead-interval <time > no ip ospf dead-interval	Sets the interval before regarding a neighbor layer3 switch invalid; the no ip ospf

	dead-interval command restores the default setting.
ip ospf transit-delay <time> no ip ospf transit-delay	Sets the delay time before sending link-state broadcast; the no ip ospf transmit-delay command restores the default setting.
ip ospf retransmit <time> no ip ospf retransmit	Sets the interval for retransmission of link-state advertisement among neighbor layer3 switches; the no ip ospf retransmit command restores the default setting.

(2) Configure OSPF route introduction parameters

Configure the routes of the other protocols to introduce to OSPF.

Command	Explanation
OSPF Protocol Configuration Mode	
redistribute { bgp connected static rip kernel} [metric-type { 1 2 }] [tag <tag>] [metric <cost_value>] [router-map <WORD>] no redistribute { bgp connected static rip kernel }	Distribute other protocols to find routing and static routings as external routing messages the no redistribute {bgp connected static rip kernel} command cancels the distributed external messages.

(3) Configure OSPF importing the routes of other OSPF processes

1) Enable the function of OSPF importing the routes of other OSPF processes

Command	Explanation
Router OSPF Mode	
redistribute ospf [<process-id>] [metric<value>] [metric-type {1 2}][route-map<word>] no redistribute ospf [<process-id>] [metric<value>] [metric-type {1 2}][route-map<word>]	Enable or disable the function of OSPF importing the routes of other OSPF processes.

2) Display relative information

Command	Explanation
Admin Mode or Configure Mode	
show ip ospf [<process-id>] redistribute	Display the configuration information of the OSPF process importing other outside routes.

3) Debug

Command	Explanation
Admin Mode	
debug ospf redistribute message send no debug ospf redistribute message send	Enable or disable debugging of sending command from OSPF process redistributed to

debug ospf redistribute route receive no debug ospf redistribute route receive	other OSPF process routing. Enable or disable debugging of received routing message from NSM for OSPF process.
---	---

(4) Configure other OSPF protocol parameters

- 1) Configure how to calculate OSPF SPF algorithm time
- 2) Configure the LSA limit in the OSPF link state database
- 3) Configure various OSPF parameters

Command	Explanation
OSPF Protocol Configuration Mode	
timers spf <interval> no timers spf	Configure the SPF timer of OSPF; the no timers spf command restores the default settings.
overflow database {<max-LSA> [hard soft] external <max-LSA> <recover time>} no overflow database [external <max-LSA> <recover time >]	Configure the LSA limit in current OSPF process database; the no overflow database [external < max-LSA > < recover time >] command restores the default settings.
area <id> {authentication [message-digest] default-cost <cost> filter-list {access prefix} <WORD> {in out} nssa [default-information-originate no-redistribution no-summary translator-role] range <range> stub [no-summary] virtual-link <neighbor>} no area <id> {authentication default-cost filter-list {access prefix} <WORD> {in out} nssa [default-information-originate no-redistribution no-summary translator-role] range <range> stub [no-summary] virtual-link <neighbor>}	Configure the parameters in OSPF area (STUB area, NSSA area and virtual links); the no area <id> {authentication default-cost filter-list {access prefix} <WORD> {in out} nssa [default-information-originate no-redistribution no-summary translator-role] range <range> stub [no-summary] virtual-link <neighbor>} command restores the default settings.

4) Configure the priority of the interface when electing designated layer3 switch (DR).

Command	Explanation
Interface Configuration Mode	
ip ospf priority <priority> no ip ospf priority	Sets the priority of the interface in “designated layer3 switch” election; the no ip ospf priority command restores the default setting.

5) Configure to keep a log for OSPF adjacency changes or not

Command	Explanation
OSPF Protocol Configuration Mode	

log-adjacency-changes detail	Configure to keep a log for OSPF adjacency changes or not.
no log-adjacency-changes detail	

6) Filter the route obtained by OSPF

Command	Explanation
OSPF Protocol Configuration Mode	
filter-policy <access-list-name>	Use access list to filter the route obtained by OSPF, the no command cancels the route filtering.
no filter-policy	

3. Disable OSPF protocol

Command	Explanation
Global Mode	
no router ospf [process <id>]	Disables OSPF routing protocol.

5.4.3 OSPF Examples

5.4.3.1 Configuration Example of OSPF

Scenario 1: OSPF autonomous system.

This scenario takes an OSPF autonomous system consists of five switch for example.

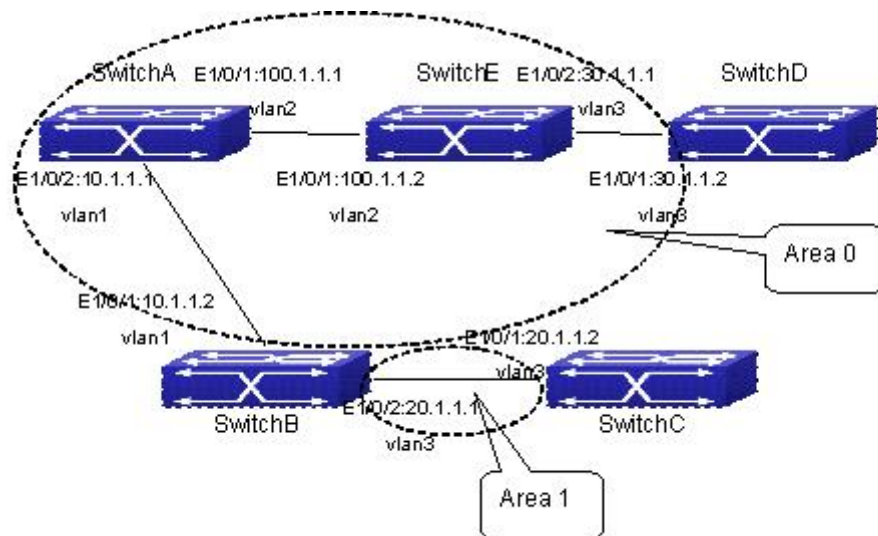

Figure 4- 5 Network topology of OSPF autonomous system

The configuration for layer3 Switch1 and Switch5 is shown below:

Layer 3 Switch1

Configuration of the IP address for interface vlan1

```
Switch1#config
```

```
Switch1(config)# interface vlan 1
```

```
Switch1(config-if-vlan1)# ip address 10.1.1.1 255.255.255.0
```

```
Switch1(config-if-vlan1)#exit
```

Configuration of the IP address for interface vlan2

Configure the IP address of interface vlan2

```
Switch1(config)# interface vlan 2
Switch1(config-if-vlan2)# ip address 100.1.1.1 255.255.255.0
Switch1 (config-if-vlan2)#exit
Enable OSPF protocol, configure the area number for interface vlan1 and vlan2.
Switch1(config)#router ospf
Switch1(config-router)#network 10.1.1.0/24 area 0
Switch1(config-router)#network 100.1.1.0/24 area 0
Switch1(config-router)#exit
Switch1(config)#exit
Switch1#
Layer 3 Switch2:
Configure the IP address for interface vlan1 and vlan2.
Switch2#config
Switch2(config)# interface vlan 1
Switch2(config-if-vlan1)# ip address 10.1.1.2 255.255.255.0
Switch2(config-if-vlan1)#no shutdown
Switch2(config-if-vlan1)#exit
Switch2(config)# interface vlan 3
Switch2(config-if-vlan3)# ip address 20.1.1.1 255.255.255.0
Switch2(config-if-vlan3)#no shutdown
Switch2(config-if-vlan3)#exit
Enable OSPF protocol, configure the OSPF area interfaces vlan1 and vlan3 in
Switch2(config)#router ospf
Switch2(config-router)# network 10.1.1.0/24 area 0
Switch2(config-router)# network 20.1.1.0/24 area 1
Switch2(config-router)#exit
Switch2(config)#exit
Switch2#
Layer 3 Switch3:
Configuration of the IP address for interface vlan3.
Switch3#config
Switch3(config)# interface vlan 3
Switch3(config-if-vlan1)# ip address 20.1.1.2 255.255.255.0
Switch3(config-if-vlan3)#no shutdown
Switch3(config-if-vlan3)#exit
Initiate the OSPF protocol, configure the OSPF area to which interface vlan3 belongs
Switch3(config)#router ospf
Switch3(config-router)# network 20.1.1.0/24 area 1
Switch3(config-router)#exit
Switch3(config)#exit
Switch3#
Layer 3 Switch4:
Configuration of the IP address for interface vlan3
Switch4#config
```

```
Switch4(config)# interface vlan 3
Switch4(config-if-vlan3)# ip address 30.1.1.2 255.255.255.0
Switch4(config-if-vlan3)# no shutdown
Switch4(config-if-vlan3)# exit
Enable OSPF protocol, configure the OSPF area in which interfaces vlan3 reside in.
Switch4(config)# router ospf
Switch4(config-router)# network 30.1.1.0/24 area 0
Switch4(config-router)# exit
Switch4(config)# exit
Switch4#
```

Layer 3 Switch5:

Configuration of the IP address for interface vlan2

```
Switch5# config
Switch5(config)# interface vlan 2
Switch5(config-if-vlan2)# ip address 100.1.1.2 255.255.255.0
Switch5(config-if-vlan2)# no shutdown
Switch5(config-if-vlan2)# exit
Configuration of the IP address for interface vlan3
Switch5(config)# interface vlan 3
Switch5(config-if-vlan3)# ip address 30.1.1.1 255.255.255.0
Switch5(config-if-vlan3)# no shutdown
Switch5(config-if-vlan3)# exit
```

Enable OSPF protocol, configure the number of the area in which interface vlan2 and vlan3 reside in.

```
Switch5(config)# router ospf
Switch5(config-router)# network 30.1.1.0/24 area 0
Switch5(config-router)# network 100.1.1.0/24 area 0
Switch5(config-router)# exit
Switch5(config)# exit
Switch5#
```

Scenario 2: Typical OSPF protocol complex topology.

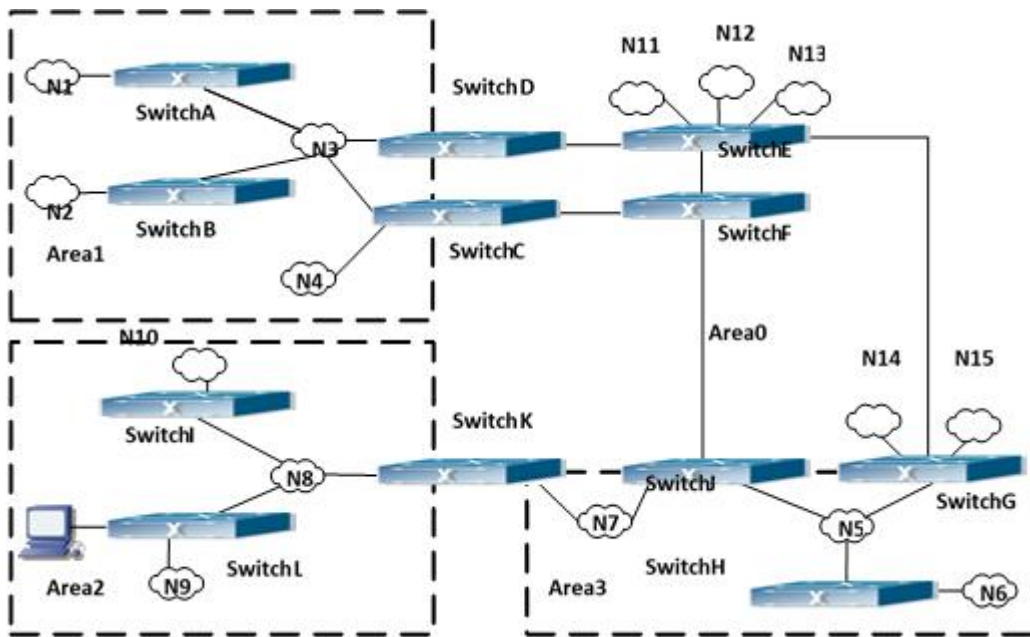

Figure 4-6 Typical complex OSPF autonomous system

This scenario is a typical complex OSPF autonomous system network topology. Area1 include network N1-N4 and layer3 SwitchA-SwitchD, area2 include network N8-N10, host H1 and layer3 SwitchH, area3 include N5-N7 and layer3 SwitchF, SwitchG SwitchA0 and Switch11, and network N8-N10 share a summary route with host H1(i.e. area3 is defined as a STUB area). Layer3 SwitchA, SwitchB, SwitchD, SwitchE, SwitchG, SwitchH, Switch12 are in-area layer3 switches, SwitchC, SwitchD, SwitchF, Switch10 and Switch11 are edge layer3 switches of the area, SwitchD and SwitchF are edge layer3 switches of the autonomous system.

To area1, layer3 switches SwitchA and SwitchB are both in-area switches, area edge switches SwitchC and SwitchD are responsible for reporting distance cost to all destination outside the area, while they are also responsible for reporting the position of the AS edge layer3 switches SwitchD and SwitchF, AS exterior link-state advertisement from SwitchD and SwitchF are flooded throughout the whole autonomous system. When ASE LSA floods in area 1, those LSAs are included in the area 1 database to get the routes to network N11 and N15.

In addition, layer3 SwitchC and SwitchD must summary the topology of area 1 to the backbone area (area 0, all non-0 areas must be connected via area 0, direct connections are not allowed), and advertise the networks in area 1 (N1-N4) and the costs from SwitchC and SwitchD to those networks. As the backbone area is required to keep connected, there must be a virtual link between backbone layer3 Switch10 and Switch11. The area edge layer3 switches exchange summary information via the backbone layer3 switch, each area edge layer3 switch listens to the summary information from the other edge layer3 switches.

Virtual link can not only maintain the connectivity of the backbone area, but also strengthen the backbone area. For example, if the connection between backbone layer3 SwitchG and Switch10 is cut down, the backbone area will become incontinuous. The backbone area can become more robust by establishing a virtual link between backbone layer3 switches SwitchF and Switch10. In addition, the virtual link between SwitchF and Switch10 provide a short path from area 3 to layer3 SwitchF.

Take area 1 as an example. Assume the IP address of layer3 SwitchA is 10.1.1.1, IP address of layer3 SwitchB interface VLAN2 is 10.1.1.2, IP address of layer3 SwitchC interface VLAN2 is 10.1.1.3, IP address of layer3 SwitchD interface VLAN2 is 10.1.1.4. SwitchA is connecting to network N1 through Ethernet interface VLAN1 (IP address 20.1.1.1); SwitchB is connecting to network N2 through Ethernet interface VLAN1 (IP address 20.1.2.1); SwitchC is connecting to network N4 through Ethernet interface VLAN3 (IP address 20.1.3.1). All the three addresses belong to area 1. SwitchC is connecting to layer3 SwitchE through Ethernet interface VLAN1 (IP address 10.1.5.1); SwitchD is connecting to layer3 SwitchD through Ethernet interface VLAN1 (IP address 10.1.6.1); both two addresses belong to area 1. Simple authentication is implemented among layer3 switches in area1, edge layer3 switches of area 1 authenticate with the area 0 backbone layer3 switches by MD5 authentication.

The followings are just configurations for all layer3 switches in area 1, configurations for layer3 switches of the other areas are omitted. The following are the configurations of SwitchA SwitchB.SwitchC and SwitchD:

1)SwitchA:

Configure IP address for interface vlan2

```
SwitchA#config
```

```
SwitchA(config)# interface vlan 2
```

```
SwitchA(config-If-Vlan2)# ip address 10.1.1.1 255.255.255.0
```

```
SwitchA(config-If-Vlan2)#exit
```

Enable OSPF protocol, configure the area number for interface vlan2.

```
SwitchA(config)#router ospf
```

```
SwitchA(config-router)#network 10.1.1.0/24 area 1
```

```
SwitchA(config-router)#exit
```

Configure simple key authentication.

```
SwitchA(config)#interface vlan 2
```

```
SwitchA(config-If-Vlan2)#ip ospf authentication
```

```
SwitchA(config-If-Vlan2)#ip ospf authentication-key test
```

```
SwitchA(config-If-Vlan2)exit
```

Configure IP address and area number for interface vlan1.

```
SwitchA(config)# interface vlan 1
```

```
SwitchA(config-If-Vlan1)#ip address 20.1.1.1 255.255.255.0
```

```
SwitchA(config-If-Vlan1)#exit
```

```
SwitchA(config)#router ospf
```

```
SwitchA(config-router)#network 20.1.1.0/24 area 1
```

```
SwitchA(config-router)#exit
```

2)SwitchB:

Configure IP address for interface vlan2

```
SwitchB#config
```

```
SwitchB(config)# interface vlan 2
```

```
SwitchB(config-If-Vlan2)# ip address 10.1.1.2 255.255.255.0
```

```
SwitchB(config-If-Vlan2)#exit
```

Enable OSPF protocol, configure the area number for interface vlan2.

```
SwitchB(config)#router ospf
```

```
SwitchB(config-router)#network 10.1.1.0/24 area 1
SwitchB(config-router)#exit
SwitchB(config)#interface vlan 2
Configure simple key authentication.
SwitchB(config)#interface vlan 2
SwitchB(config-If-Vlan2)#ip ospf authentication
SwitchB(config-If-Vlan2)#ip ospf authentication-key test
SwitchB(config-If-Vlan2)#exit
Configure IP address and area number for interface vlan1.
SwitchB(config)# interface vlan 1
SwitchB(config-If-Vlan1)#ip address 20.1.2.1 255.255.255.0
SwitchB(config-If-Vlan1)#exit
SwitchB(config)#router ospf
SwitchB(config-router)#network 20.1.2.0/24 area 1
SwitchB(config-router)#exit
SwitchB(config)#exit
3)SwitchC:
Configure IP address for interface vlan2
SwitchC#config
SwitchC(config)# interface vlan 2
SwitchC(config-If-Vlan2)# ip address 10.1.1.3 255.255.255.0
SwitchC(config-If-Vlan2)#exit
Enable OSPF protocol, configure the area number for interface vlan2
SwitchC(config)#router ospf
SwitchC(config-router)#network 10.1.1.0/24 area 1
SwitchC(config-router)#exit
Configure simple key authentication
SwitchC(config)#interface vlan 2
SwitchC(config-If-Vlan2)#ip ospf authentication
SwitchC(config-If-Vlan2)#ip ospf authentication-key test
SwitchC(config-If-Vlan2)#exit
Configure IP address and area number for interface vlan3
SwitchC(config)# interface vlan 3
SwitchC(config-If-Vlan3)#ip address 20.1.3.1 255.255.255.0
SwitchC(config-If-Vlan3)#exit
SwitchC(config)#router ospf
SwitchC(config-router)#network 20.1.3.0/24 area 1
SwitchC(config-router)#exit
Configure IP address and area number for interface vlan 1
SwitchC(config)# interface vlan 1
SwitchC(config-If-Vlan1)#ip address 10.1.5.1 255.255.255.0
SwitchC(config-If-Vlan1)#exit
SwitchC(config)#router ospf
SwitchC(config-router)#network 10.1.5.0/24 area 0
```

```

SwitchC(config-router)#exit
Configure MD5 key authentication.
SwitchC(config)#interface vlan 1
SwitchC (config-If-Vlan1)#ip ospf authentication message-digest
SwitchC (config-If-Vlan1)#ip ospf authentication-key test
SwitchC (config-If-Vlan1)#exit
SwitchC(config)#exit
SwitchC#
4)SwitchD:
Configure IP address for interface vlan2
SwitchD#config
SwitchD(config)# interface vlan 2
SwitchD(config-If-Vlan2)# ip address 10.1.1.4 255.255.255.0
SwitchD(config-If-Vlan2)#exit
Enable OSPF protocol, configure the area number for interface vlan2.
SwitchD(config)#router ospf
SwitchD(config-router)#network 10.1.1.0/24 area 1
SwitchD(config-router)#exit
Configure simple key authentication.
SwitchD(config)#interface vlan 2
SwitchD(config-If-Vlan2)#ip ospf authentication
SwitchD(config-If-Vlan2)#ip ospf authentication-key test
SwitchD(config-If-Vlan2)#exit
Configure the IP address and the area number for the interface vlan 1
SwitchD(config)# interface vlan 1
SwitchD(config-If-Vlan1)# ip address 10.1.6.1 255.255.255.0
SwitchD(config-If-Vlan1)exit
SwitchD(config)#router ospf
SwitchD(config-router)#network 10.1.6.0/24 area 0
SwitchD(config-router)#exit
Configure MD5 key authentication
SwitchD(config)#interface vlan 1
SwitchD(config-If-Vlan1)#ip ospf authentication message-digest
SwitchD(config-If-Vlan1)#ip ospf authentication-key test
SwitchD(config-If-Vlan1)exit
SwitchD(config)#exit
SwitchD#

```

Scenario 3: The function of OSPF importing the routers of other OSPF processes

As shown in the following graph, a switch running the OSPF routing protocol connects two networks: network A and network B. Because of some reason, it is required that network A should be able to learn the routers of network B, but network B should not be able to learn the routers of network A. According to that, two OSPF processes can be started respectively on interface vlan 1 and interface vlan 2. the OSPF process which interface vlan 1 belongs to is configured to import

the routers of the OSPF process which interface vlan 2 belongs to, while the OSPF process which interface vlan 2 belongs to should not be configured to import the routers of the OSPF process which interface vlan 1 belongs to.

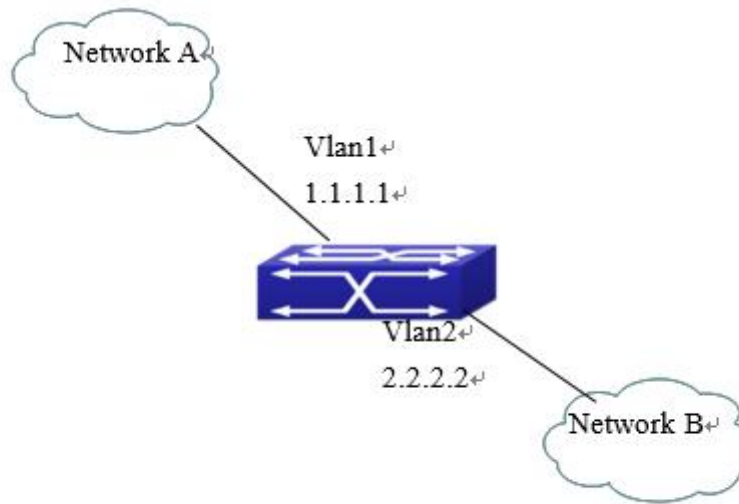

Figure 4- 7 Function of OSPF importing the routers of other OSPF processes example

We can configure as follows:

```
Switch(config)#interface vlan 1
Switch(Config-if-Vlan1)#ip address 1.1.1.1 255.255.255.0
Switch(Config-if-Vlan1)#exit
Switch(config)#interface vlan 2
Switch(Config-if-Vlan2)#ip address 2.2.2.2 255.255.255.0
Switch(Config-if-Vlan2)#exit
Switch(config)#router ospf 10
Switch(config-router)#network 2.2.2.0/24 area 1
Switch(config-router)#exit
Switch(config)#router ospf 20
Switch(config-router)#network 1.1.1.0/24 area 1
Switch(config-router)#redistribute ospf 10
Switch(config-router)#exit
```

5.4.3.2 Configuration Examples of OSPF VPN

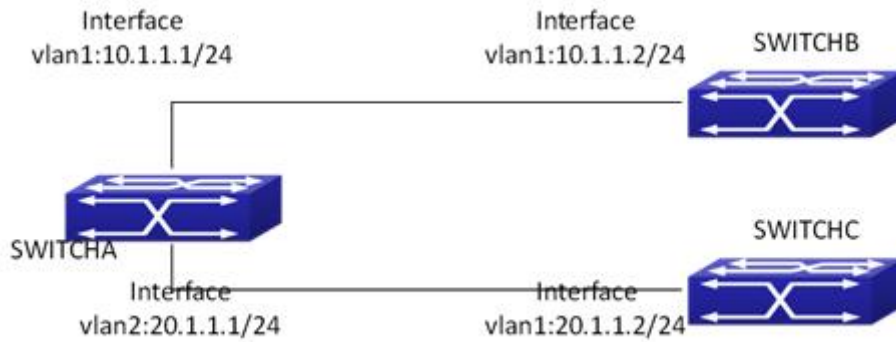

Figure 4-8 OSPF VPN Example

The above figure shows that a network consists of three Layer 3 switches in which the switchA as PE, SwitchB and SwitchC as CE1 and CE2. The PE is connected to CE1 and CE2 through vlan1 and vlan2. The routing messages are exchanged between PE and CE through OSPF protocol.

a) SwitchA, the Layer 3 switch as PE

Configure VPN route/transmitting examples vpng and vpnc

```
SwitchA#config
```

```
SwitchA(config)#ip vrf vpng
```

```
SwitchA(config-vrf)#
```

```
SwitchA(config-vrf)#exit
```

```
SwitchA#(config)
```

```
SwitchA(config)#ip vrf vpnc
```

```
SwitchA(config-vrf)#
```

```
SwitchA(config-vrf)#exit
```

Associate the vlan 1 and vlan 2 respectively with vpng and vpnc while configuring IP address

```
SwitchA(config)#in vlan1
```

```
SwitchA(config-if-Vlan1)#ip vrf forwarding vpng
```

```
SwitchA(config-if-Vlan1)#ip address 10.1.1.1 255.255.255.0
```

```
SwitchA(config-if-Vlan1)#exit
```

```
SwitchA(config)#in vlan2
```

```
SwitchA(config-if-Vlan2)#ip vrf forwarding vpnc
```

```
SwitchA(config-if-Vlan2)#ip address 20.1.1.1 255.255.255.0
```

```
SwitchA(config-if-Vlan2)#exit
```

Configure OSPF examples associated with vpng and vpnc respectively

```
SwitchA(config)#
```

```
SwitchA(config)#router ospf 100 vpng
```

```
SwitchA(config-router)#network 10.1.1.0/24 area 0
```

```
SwitchA(config-router)#redistribute bgp
```

```
SwitchA(config-router)#exit
```

```
SwitchA(config)#router ospf 200 vpnc
```

```
SwitchA(config-router)#network 20.1.1.0/24 area 0
```

```
SwitchA(config-router)#redistribute bgp
```

b) The Layer 3 SwitchB of CE1:

```
Configure the IP address of Ethernet E 1/0/2
SwitchB#config
SwitchB(config)# interface Vlan1
SwitchB(config-if-vlan1)# ip address 10.1.1.2 255.255.255.0
SwitchB (config-if-vlan1)#exit
Enable OSPF protocol and configuring OSPF segments
SwitchB(config)#router ospf
SwitchB(config-router)#network 10.1.1.0/24 area 0
SwitchB(config-router)#exit

c) The Layer 3 SwitchC of CE2
Configure the IP address of Ethernet E 1/0/2
SwitchC#config
SwitchC(config)# interface Vlan1
SwitchC(config-if-vlan1)# ip address 20.1.1.2 255.255.255.0
SwitchC(config-if-vlan1)#exit
Initiate OSPF protocol and configuring OSPF segments
SwitchC(config)#router ospf
SwitchC(config-router)#network 20.1.1.0/24 area 0
SwitchC(config-router)#exit
```

5.4.4 OSPF Troubleshooting

The OSPF protocol may not be working properly due to errors such as physic connection, configuration error when configuring and using the OSPF protocol. So users should pay attention to following:

- ☞ First ensure the physic connection is correct
- ☞ Second, ensure the interface and link protocol are UP (use **show interface** command)
- ☞ Configure different IP address from different segment on each interface
- ☞ Then initiate OSPF protocol (use **router-ospf** command) and configure the OSPF area on corresponding interface
- ☞ After that, a OSPF protocol feature should be checked---the OSPF backbone area should be continuous and apply virtual link to ensure it is continuous. if not; all non 0 areas should only be connected to other non 0 area through 0 area; a border Layer 3 switch means that one part of the interfaces of this switch belongs to 0 area, the other part belongs to non 0 area; Layer 3 switch DR should be specified for multi-access network such as broadcast network.

5.5 BGP

5.5.1 Introduction to BGP

BGP stands for a Border Gateway Protocol. It's a dynamic routing protocol inter-autonomous system. Its basic function is automatically exchanging routing information without loops. By exchanging routing reachable information with autonomous number of AS sequence attributes, BGP could create autonomous topological map to eliminate routing loop and implement policies configured by users. Generally, the switches in an AS may use several IGPs (Interior Gateway Protocol) in order to exchange routing information in the AS, such as RIP and OSPF which are IGPs; and exchange information among ASes with EGP (Exterior Gateway Protocol). For example, BGP is one kind of EGP. The AS is usually established on a single administrative department. BGP is often used on the switches among ISPs or the departments of Multi-national Corporation.

BGP has been used since 1989, its earliest three versions are RFC1105 (BGP-1), RFC1163 (BGP-2) and RFC1267 (BGP-3). Currently, the most popular one is RFC1771 (BGP-4). The switch supports BGP-4.

1. Characteristics of BGP-4

BGP-4 is suitable for the distributed structure and supports Classless InterDomain Routing (CIDR). BGP-4 is becoming the virtual exterior routing protocol standard used for the global Internet. The features of BGP-4 are as follows.

- BGP is an exterior routing protocol, unlike interior routing protocol, such as OSPF and RIP, BGP can't discovery and calculate routes, but it can control the transmission of routes and select the best route.
- By carrying AS routing information in the updating route, the problem of Routing Loops can be resolved
- BGP uses TCP on port 179 as its transport protocol, this could enhance the reliability of the protocol.
- BGP-4 supports CIDR (Classless InterDomain Routing), which is an important improvement to BGP-3. CIDR has a brand new way to look on IP address; it doesn't distinguish class A, Class B and class C network. For instance, an illegal class C address 192.213.0.0 255.255.0.0 can be represented as 192.213.0.0/16 by CIDR which is a legal super network. /16 represents that the network number is formed by 16 bits from the beginning left of the address. The introduction of CIDR abbreviates the route aggregation. The route aggregation is the process of combining several different routes. So notifying several routes can be changed to notify only one route which decreases the route table.
- When updating route, BGP send only incremental route. The bandwidth occupied by BGP transmission is reduced greatly and it is suitable for the mass routing information transmitted on the internet
- For political and economical reasons, each AS expects to filter and control the route,

BGP-4 provides abundant route policies which make BGP-4 more extendable to encourage the internet development.

2. The Overview of BGP-4 operation

Unlike RIP and OSPF protocols, BGP protocol is connection oriented. BGP switches must establish connection to exchange routing information. The operation of BGP protocol is driven by messages and the messages can be divided into four kinds:

Open message----It's the first message which is sent after a TCP connection is established. It is used to create BGP connecting relation among BGP peers. Some parameters in Open Message are used to negotiate if a connection could be established among BGP peers.

Keepalive Message ----- it's the message to check connection availability. It's usually sent periodically to keep BGP connection. If this message or Update message is not received within holdtime time, BGP connection is closed.

Update Message----- it's the most important message in the BGP system. It's used to exchange routing information among peers. The switches exchange not only updated routing information, but also unavailable or canceled routing information. It consists of three parts: unreachable route, NLRI (Network LayerReachability Information) and Path Attributes.

Notification Message-----it's the mistake notification message. When a BGP speaker receives this message, it shutdowns the BGP connections with its neighbors

BGP-4 is connection oriented. BGP acts as higher protocol and runs on the particular equipments. When detecting a neighbor, a TCP session is established and maintained. Then the exchanging and synchronization of the route table will be carried out. By sending the whole BGP route table the routing information is exchanged only when the system initiates. After that, the routing information is exchanged only when the updated routing information is available. Only incremental update message is exchanged. BGP-4 maintains links and sessions periodically through keep alive message. That is sending and receiving keep alive message periodically to check if the connections are normal.

The switches that participate the BGP session are called BGP speaker. It continuously receives or generates new routing information and advertises it to other BGP speakers. When a BGP speaker receives a new routing notification from other AS, if this route is better than the presently known route or there is no acceptable route, it sends this route to all the other BGP speakers of the AS. A BGP speaker calls other speakers that exchange route information with it as neighbors or peers. Several relevant neighbors can constitute a peer group. BGP operates on the switches in the following two manners:

- IBGP: Internal BGP
- EBGP: External BGP

When BGP runs in the same AS, it's called IBGP. When in the different AS, it's called EBGP. Generally, the outer neighbors are connected physically and the inner neighbors can be in any place of the AS. The difference is finally shown in the dealing manner of BGP to routing information. The equipments may check the AS numbers of the Open Message from neighbors to decide treating the neighbor switches as the exterior neighbor or as the interior neighbor.

IBGP are used in the AS. It sends message to all the BGP neighbors in the AS. IBGP exchanges AS routing information in a big organization. Attention, the switches in the AS needn't be connected physically. Only if the switches are in the same AS, they can be neighbors each other. Because BGP can't detect route, the route tables of other inner route protocols (such as static route,

direct route, OSPF and RIP) need contain neighbor IP addresses and these routes are used to exchange information among BGPs. In order to avoid routing loops, when a BGP speaker receives a route notification from inner neighbor, it would not notify this route to other inner neighbors.

EBGP is used among the AS, and it transmits routing information to the BGP neighbors of outer ASes. EBGP need physical connection and share the same medium. Because EBGP need physical connection, the boundary equipments between two AS are usually running EBGP. When a BGP speaker receives routing information from outer neighbors, it notifies these routes to other inner neighbors.

3. Route attribute

BGP-4 can share and query inner IP route table through relevant mechanisms, but it has its own route table. In the BGP route table, each route has a network number, AS listing information (also called AS path) that it passed and some routing attributes (such as origin). The routing attribute that BGP-4 used is very complex, this attribute can be used as metrics to select path.

4. Route-selecting policy of BGP

When receiving BGP notification about a same route from several neighbors, selecting the best route need to be take into account after routing filtering. This process is called BGP route selecting process. BGP route selecting process will start only when the following conditions are fulfilled:

- The switch's route must be next hop reachable. That is in the route table there is the route that can reach the next hop.
- BGP must be synchronized with IGP (unless asynchronism is configured; only restricted to IBGP)

BGP route selecting process is based on the BGP attribute. When there are several routes that indicate the same destination, BGP need select the best route to the destination. The decision-making process is as the following:

1. Select the route with the most weight first;
2. If the weights are the same, select the route with the most local preference;
3. If the local preferences are the same, select the route generated by local switch.
4. If the local preferences are the same and there is no route generated by local switch, select the route with the shortest AS path;
5. If the AS paths are the same, select the route with the lowest "origin" type (IGP<EGP<INCOMPLETE);
6. If the "origin" types are the same, select the route with the lowest MED attribute. Unless activating command "bgp always-compare-med", this comparison is only available among the routes from the same neighbor AS.
7. If the MED attributes are the same, EBGP is preferable to outer confederation and outer confederation is preferable to IBGP.
8. If it's still the same by now, BGP router ID (router ID) is used to break the balance. The best route is the one from the least router ID.
9. If it's still the same by now, BGP router ID (router ID) is used to break the balance. The best route is the one from the least router ID.

5.5.2 BGP Configuration Task List

The BGP configuration tasks include basic and advanced tasks. Basic BGP configuration tasks include the following:

1. Enable BGP Routing (required)
2. Configure BGP Neighbors (required)
3. Administrate the change of routing policy
4. Configure BGP Weights
5. Configure BGP Route Filtering policy basing on Neighbors
6. Configure Next-Hop of BGP
7. Configure Multi-Hop of EGBP
8. Configure BGP Session Identifier
9. Configure BGP Version

Advanced BGP configuration tasks include the following:

1. Use Route Maps to Modify Route
2. Configure Route Aggregation
3. Configure BGP Community Filtering
4. Configure BGP Confederation
5. Configure a Route Reflector
6. Configure Peer Groups
7. Configure Neighbors and Peer Groups' Parameters
8. Adjust BGP Timers
9. Adjust BGP Announcement Interval
10. Configure the default Local Priority
11. Allow to Transfer Default Route
12. Configure BGP's MED Value
13. Configure BGP Routing Redistribution
14. Configure BGP Route Dampening
15. Configure BGP capability Negotiation
16. Configure Routing Server
17. Configure Path-Selected Rule
18. Configure redistribution of OSPF routing to BGP
 - (1) Enable redistribution of OSPF routing to BGP
 - (2) Display and debug the information about configuration of redistribution of OSPF routing to BGP

I . Basic BGP configuration tasks

1. Enable BGP Routing

Command	Explanation
---------	-------------

Global mode	
router bgp <as-id> no router bgp <as-id>	Enable BGP, the no router bgp <as-id> command disables BGP process.
BGP protocol mode	
bgp asnotation asdot no bgp asnotation asdot	Show AS number and match the regular expression with ASDOT method . <i>The no</i> command cancels this method.
network <ip-address/M> no network <ip-address/M>	Set the network that BGP will announce, the no network <ip-address/M> command cancels the network that will be announced.
address-family ipv4 {unicast multicast vrf <vrf-nam>} no address-family ipv4 {unicast multicast vrf <vrf-nam>}	Create IPv4 for BGP protocol and enter BGP-VPN view. Any IPv4 is not created by default.

2. Configure BGP Neighbors

Command	Explanation
Router configuration mode	
neighbor {<ip-address> <TAG>} remote-as <as-id> no neighbor {<ip-address> <TAG>} [remote-as <as-id>]	Specify a BGP neighbor, the no neighbor {<ip-address> <TAG>} [remote-as <as-id>] command deletes the neighbor.

3. Administrate the change of routing policy

(1) Configure hard reconfiguration.

Command	Explanation
Admin Mode	
clear ip bgp {<*> <as-id> external peer-group <NAME> <ip-address>}	Configure hard reconfiguration.

(2) Configure outbound soft reconfiguration.

Command	Explanation
Admin Mode	
clear ip bgp {<*> <as-id> external peer-group <NAME> <ip-address>} soft out	Configure outbound soft reconfiguration.

(3) Configure inbound soft reconfiguration.

Command	Explanation
BGP configuration mode	
neighbor { <ip-address> <TAG> } soft-reconfiguration inbound	This command can store routing information from neighbors and

no neighbor { <ip-address> <TAG> } soft-reconfiguration inbound	peers; the no neighbor { <ip-address> <TAG> } soft-reconfiguration inbound command cancels the storage of routing information.
Admin Mode	
clear ip bgp {<*> <as-id> external peer-group <NAME> <ip-address>} soft in	Configure BGP inbound soft reconfiguration.

4. Configure BGP Weights

Command	Explanation
BGP configuration mode	
neighbor { <ip-address> <TAG> } weight <weight> no neighbor { <ip-address> <TAG> }	Configure BGP neighbor weights; the no neighbor { <ip-address> <TAG> } command recovers default weights.

5. Configure BGP Route Filtering policy based on neighbor

Command	Explanation
BGP configuration mode	
neighbor {<ip-address> <TAG>} distribute-list {<1-199> <1300-2699> <WORD>} {in out} no neighbor {<ip-address> <TAG>} distribute-list {<1-199> <1300-2699> <WORD>} {in out}	Filter neighbor routing updating information. The no neighbor {<ip-address> <TAG>} distribute-list {<1-199> <1300-2699> <WORD>} {in out} command cancels routing filter.

6. Configure Next-Hop

1) Set Next-Hop as the switch's address

Command	Explanation
BGP configuration mode	
neighbor { <ip-address> <TAG> } next-hop-self no neighbor { <ip-address> <TAG> } next-hop-self	While sending route Next-Hop set Next-Hop as the switch's address; the no neighbor { <ip-address> <TAG> } next-hop-self command cancels the setting.

2) Cancel default Next-Hop through route map

Command	Explanation
Route mapped configuration command	
set ip next-hop <ip-address> no set ip next-hop	Set the Next-Hop attribute of outbound route. The no set ip next-hop command cancels this setting.

7. Configure EGBP Multi-Hop

If the connections with outer neighbors are not direct, the following command can configure neighbor Multi-Hop.

Command	Explanation
BGP configuration mode	
neighbor {<ip-address> <TAG>} ebgp-multihop [<1-255>] no neighbor {<ip-address> <TAG>} ebgp-multihop [<1-255>]	Configure the allowance of EGBP connection with other networks that are not connected directly; the no neighbor {<ip-address> <TAG>} ebgp-multihop [<1-255>] command cancels the setting.

8. Configure BGP session identifier

Command	Explanation
BGP configuration mode	
bgp router-id <ip-address> no bgp router-id	Configure the router-id value; the no bgp router-id command recovers the default value.

9. Configure the BGP Version

Command	Explanation
BGP configuration mode	
neighbor {<ip-address> <TAG>} version <value> no neighbor {<ip-address> <TAG>} version	Set the version used by BGP neighbors; the no neighbor {<ip-address> <TAG>} version command recovers default setting. Presently only supporting version 4 th .

II . Advanced BGP configuration tasks

1. Use Route Maps to Modify Route

Command	Explanation
BGP configuration mode	
neighbor { <ip-address> <TAG> } route-map <map-name> {in out} no neighbor { <ip-address> <TAG> } route-map <map-name> {in out}	Apply a route map to incoming or outgoing routes; the no neighbor { <ip-address> <TAG> } route-map <map-name> {in out} command cancels the settings of routing maps.

2. Configure Route Aggregation

Command	Explanation
BGP configuration mode	

aggregate-address <ip-address/M> [summary-only] [as-set] no aggregate-address <ip-address/M> [summary-only] [as-set]	Create an aggregate entry in the BGP routing table; the no aggregate-address <ip-address/M> [summary-only] [as-set] command cancels the aggregate entry.
---	---

3. Configure BGP Community Filtering

Command	Explanation
BGP configuration mode	
neighbor {<ip-address> <TAG>} send-community no neighbor {<ip-address> <TAG>} send-community	Allow the routing updates with community attributes sending to BGP neighbors; the no neighbor {<ip-address> <TAG>} send-community command enables the route without community attributes.

4. Configure BGP Confederation

Command	Explanation
BGP configuration mode	
bgp confederation identifier <as-id> no bgp confederation identifier <as-id>	Configure a BGP AS confederation identifier; the no bgp confederation identifier <as-id> command deletes the BGP AS confederation identifier.
bgp confederation peers <as-id> [<as-id>..] no bgp confederation peers <as-id> [<as-id>..]	Configure the AS affiliated to the AS confederation; the no bgp confederation peers <as-id> [<as-id>..] command deletes the AS from the AS confederation.

5. Configure a Route Reflector

(1) The following commands can be used to configure route reflector and its clients.

Command	Explanation
BGP configuration mode	
neighbor <ip-address> route-reflector-client no neighbor <ip-address> route-reflector-client	Configure the current switch as route reflector and specify a client; the no neighbor <ip-address> route-reflector-client command format deletes a client.

(2) If there are more than one route reflectors in the cluster, the following commands

can configure cluster-id

Command	Explanation
BGP configuration mode	
bgp cluster-id <cluster-id> no bgp cluster-id	Configure cluster id; the no bgp cluster-id command cancels the cluster id configuration.

(3) If the route reflector from clients to clients is needed, the following commands can be used.

Command	Explanation
BGP configuration mode	
bgp client-to-client reflection no bgp client-to-client reflection	Configure the allowance of the route reflector from clients to clients; the no bgp client-to-client reflection command forbids this allowance.

6. Configure Peer Groups

(1) Create peer groups

Command	Explanation
BGP configuration mode	
neighbor <TAG> peer-group no neighbor <TAG> peer-group	Create peer groups; the no neighbor <TAG> peer-group command deletes peer groups.

(2) Add neighbors to peers groups

Command	Explanation
BGP configuration mode	
neighbor <ip-address> peer-group <TAG> no neighbor <ip-address> peer-group <TAG>	Make a neighbor a member of the peer group. The no neighbor <ip-address> peer-group <TAG> command cancels the specified member.

7. Configure neighbors and peer Groups' parameters

Command	Explanation
BGP configuration mode	
neighbor {<ip-address> <TAG>} remote-as <as-id> no neighbor {<ip-address> <TAG>} remote-as <as-id>	Specify a BGP neighbor; the no neighbor {<ip-address> <TAG>} remote-as <as-id> command deletes the neighbor.
neighbor { <ip-address> <TAG> } description <LINE> no neighbor { <ip-address> <TAG> } description	Associate a description with a neighbor; the no neighbor {<ip-address> <TAG>} description command deletes this description.
neighbor { <ip-address> <TAG> } default-originate [route-map <NAME>]	Permit to send the default route 0.0.0.0; the no neighbor

<pre>no neighbor { <ip-address> <TAG> } default-originate [route-map <NAME>]</pre>	<pre>{ <ip-address> <TAG> } default-originate [route-map <NAME>] command cancels sending default route.</pre>
<pre>neighbor { <ip-address> <TAG> } send-community no neighbor { <ip-address> <TAG> } send-community</pre>	<p>Configure the community attributes sent to the neighbor.</p>
<pre>neighbor { <ip-address> <TAG> } timers <keep alive> <holdtime> no neighbor { <ip-address> <TAG> } timers</pre>	<p>Configure a particular neighbor's keep-alive and hold-time timer; the no neighbor {<ip-address> <TAG>} timers command recovers the default value.</p>
<pre>neighbor {<ip-address> <TAG>} advertisement-interval <seconds> no neighbor {<ip-address> <TAG>} advertisement-interval</pre>	<p>Configure the min interval of sending BGP routing information; the no neighbor {<ip-address> <TAG>} advertisement-interval command recovers the default value.</p>
<pre>neighbor {<ip-address> <TAG>} ebgp-multihop [<1-255>] no neighbor {<ip-address> <TAG>} ebgp-multihop</pre>	<p>Configure the allowance of EBGP connections with networks connected indirectly; the no neighbor {<ip-address> <TAG>} ebgp-multihop command cancels this setting.</p>
<pre>neighbor { <ip-address> <TAG> } weight <weight> no neighbor { <ip-address> <TAG> } weight</pre>	<p>Configure BGP neighbor weights; the no neighbor { <ip-address> <TAG> } weight command recovers the default weights.</p>
<pre>neighbor { <ip-address> <TAG> } distribute-list { <access-list-number> <name> } { in out } no neighbor { <ip-address> <TAG> } distribute-list { <access-list-number> <name> } { in out }</pre>	<p>Filter neighbor route update; the no neighbor { <ip-address> <TAG> } distribute-list { <access-list-number> <name> } { in out } command cancels route filtering.</p>
<pre>neighbor { <ip-address> <TAG> } route-reflector-client no neighbor { <ip-address> <TAG> } route-reflector-client</pre>	<p>Configure the current switch as route reflector and specify a client; the no neighbor { <ip-address> <TAG> } route-reflector-client command deletes a client.</p>
<pre>neighbor { <ip-address> <TAG> } next-hop-self no neighbor { <ip-address> <TAG> } next-hop-self</pre>	<p>When sending route, configure Next-Hop as its address; the no neighbor { <ip-address> <TAG> } next-hop-self command cancels the setting.</p>

neighbor { <ip-address> <TAG> } version <value> no neighbor { <ip-address> <TAG> } version	Specify the BGP version communicating with BGP neighbors; the no neighbor { <ip-address> <TAG> } version command recovers default setting.
neighbor { <ip-address> <TAG> } route-map <map-name> {in out} no neighbor { <ip-address> <TAG> } route-map <map-name> {in out}	Apply a route map to incoming or outgoing routes; the no neighbor { <ip-address> <TAG> } route-map <map-name> {in out} command cancels the setting of route reflector.
neighbor { <ip-address> <TAG> } soft-reconfiguration inbound no neighbor { <ip-address> <TAG> } soft-reconfiguration inbound	Store the route information from neighbor or peers; the no neighbor { <ip-address> <TAG> } soft-reconfiguration inbound command cancels the storage.
neighbor { <ip-address> <TAG> } shutdown no neighbor { <ip-address> <TAG> } shutdown	Shutdown BGP neighbor or peers; the no neighbor { <ip-address> <TAG> } shutdown command activates the closed BGP neighbor or peers.

8. Adjust BGP Timers

(1) Configure the BGP timer of all the neighbors

Command	Explanation
BGP configuration mode	
timers bgp <keep alive> <holdtime> no timers bgp	Configure the BGP timers of all the neighbors; the no timer bgp command recovers the default value.

(2) Configure the timer value of a particular neighbor

Command	Explanation
BGP configuration mode	
neighbor { <ip-address> <TAG> } timers <keep alive> <holdtime> no neighbor { <ip-address> <TAG> } timers	Configure the keep alive and holdtime timer of a particular neighbor; the no neighbor { <ip-address> <TAG> } timers command recovers the default value.

9. Adjust BGP announcement Interval

Command	Explanation
BGP configuration mode	

neighbor {<ip-address> <TAG>} advertisement-interval <seconds> no neighbor {<ip-address> <TAG>} advertisement-interval	Configure the minimum interval among BGP routes update information; the no neighbor {<ip-address> <TAG>} advertisement-interval command recovers the default setting.
---	---

10. Configure the Local Preference Value

Command	Explanation
BGP configuration mode	
bgp default local-preference <value> no bgp default local-preference	Change default local preference; the no bgp default local-preference command recovers the default value.

11. Enable sending default route

Command	Explanation
BGP configuration mode	
neighbor { <ip-address> <TAG> } default-originate no neighbor { <ip-address> <TAG> } default-originate	Permit sending default route 0.0.0.0; the no neighbor { <ip-address> <TAG> } default-originate command cancels sending default route.

12. Configure BGP's MED Value

(1) Configure MED value

Command	Explanation
Route map configuration command	
set metric <metric-value> no set metric	Configure metric value; the no set metric command recovers the default value.

(2) Apply route selection based on MED according to the path from different AS

Command	Explanation
BGP configuration mode	
bgp always-compare-med no bgp always-compare-med	Permit the MED comparison from different AS; the no bgp always-compare-med command forbids the comparison.

13. Configure BGP routing redistribution

Command	Explanation
BGP configuration mode	
redistribute { connected static rip ospf } [metric <metric>] [route-map	Redistribute IGP routes to BGP and may specify the redistributed metric and route

<NAME> no redistribute { connected static rip ospf }	reflector; the no redistribute { connected static rip ospf } command cancels the redistribution.
---	---

14. Configure Route Dampening

Command	Explanation
BGP configuration mode	
bgp dampening [<1-45> [<1-2000> <1-2000> <1-255>] [<1-45>] no bgp dampening	Enable BGP route dampening and apply the specified parameters; the no bgp dampening command stops route dampening

15. Configure BGP capability Negotiation

Command	Explanation
BGP configuration mode	
neighbor {<ip-address> <TAG>} capability {dynamic route-refresh} no neighbor {<ip-address> <TAG>} capability {dynamic route-refresh} neighbor {<ip-address> <TAG>} capability orf prefix-list {<both> <send> <receive>} no neighbor {<ip-address> <TAG>} capability orf prefix-list {<both> <send> <receive>} neighbor {<ip-address> <TAG>} dont-capability-negotiate no neighbor {<ip-address> <TAG>} dont-capability-negotiate neighbor {<ip-address> <TAG>} override-capability no neighbor {<ip-address> <TAG>} override-capability neighbor {<ip-address> <TAG>} strict-capability-match no neighbor {<ip-address> <TAG>} strict-capability-match	BGP provides capability negotiation regulation and carry out this capability match while establishing connection. The currently supported capabilities include route update, dynamic capability, outgoing route filtering capability and the address family's capability of supporting the negotiation. Use these command to enable these capabilities, its format "no" close these capabilities .It can also be configured by commands to not do capability negotiation, do strict capability negotiation or not care about the negotiation results.

16. Configure Routing Server

Command	Explanation
BGP configuration mode	
neighbor {<ip-address> <TAG>} route-server-client no neighbor {<ip-address> <TAG>} route-server-client	Route server may configure BGP neighbors under EBGp environment to reduce the number of peers that every client has configured; format "no" of the command configures this router as route server and

	specify the clients it serves, the no neighbor {<ip-address> <TAG>} route-server-client command can delete clients.
--	---

17. Configure Path-selected rules

Command	Explanation
BGP configuration mode	
bgp always-compare-med no bgp always-compare-med bgp bestpath as-path ignore no bgp bestpath as-path ignore bgp bestpath compare-confed-asp no bgp bestpath compare-confed-asp bgp bestpath compare-routerid no bgp bestpath compare-routerid bgp bestpath med {{confed}} [missing-is-worst]} no bgp bestpath med {{confed}} [missing-is-worst]}	BGP may change some path-select rules by configuration to change the best selection and compare MED under EBGP environment through these command, ignore the AS-PATH length, compare the confederation as-path length, compare the route identifier and compare the confederation MED etc. Its format “no” recovers the default route path-selected rules.

18. Configure redistribution of OSPF routing to BGP

(1) Enable redistribution of OSPF routing to BGP

Command	Explanation
Router BGP Configuration Mode	
redistribute ospf [<process-id>] [route-map<word>] no redistribute ospf [<process-id>]	To enable or disable the redistribution of OSPF routing to BGP.

(2) Display and debug the information about configuration of redistribution of OSPF routing to BGP

Command	Explanation
Admin Mode and Configuration Mode	
show ip bgp redistribute	To enable or disable the redistribution of OSPF routing to BGP.
Admin Mode	
debug bgp redistribute message send no debug bgp redistribute message send debug bgp redistribute route receive no debug bgp redistribute route receive	To enable or disable debugging messages sent by BGP for redistributing OSPF routing. To enable or disable debugging messages received from NSM for redistributing OSPF routing.

5.5.3 Configuration Examples of BGP

5.5.3.1 Examples 1: configure BGP neighbor

SwitchB, SwitchC and SwitchD are in AS200, SwitchA is in AS100. SwitchA and SwitchB

share the same network segment. SwitchB and SwitchD are not connected physically.

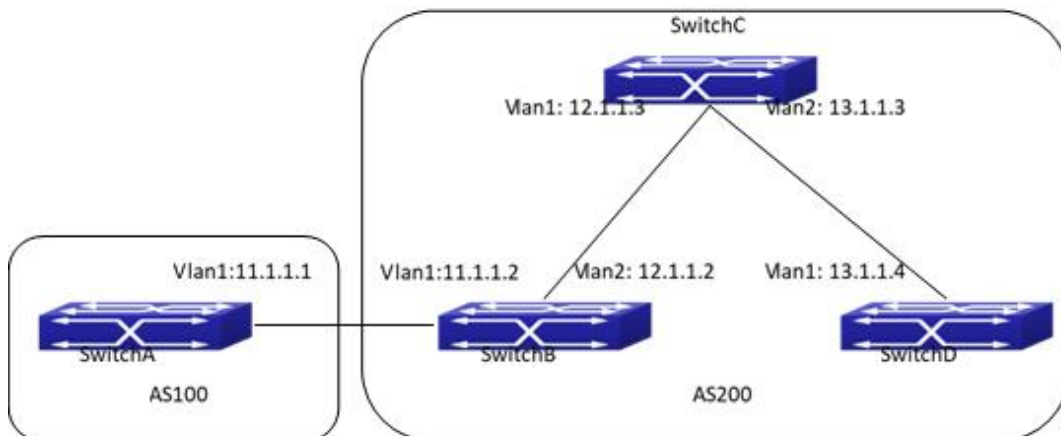

Figure 4-9 BGP Network Topological Map

The configurations of SwitchA are as following:

```
SwitchA(config)#router bgp 100
SwitchA(config-router-bgp)#neighbor 11.1.1.2 remote-as 200
SwitchA(config-router-bgp)#exit
```

The configurations of SwitchB are as following:

```
SwitchB(config)#router bgp 200
SwitchB(config-router-bgp)#network 11.0.0.0
SwitchB(config-router-bgp)#network 12.0.0.0
SwitchB(config-router-bgp)#network 13.0.0.0
SwitchB(config-router-bgp)#neighbor 11.1.1.1 remote-as 100
SwitchB(config-router-bgp)#neighbor 12.1.1.3 remote-as 200
SwitchB(config-router-bgp)#neighbor 13.1.1.4 remote-as 200
SwitchB(config-router-bgp)#exit
```

The configurations of SwitchC are as following:

```
SwitchC(config)#router bgp 200
SwitchC(config-router-bgp)#network 12.0.0.0
SwitchC(config-router-bgp)#network 13.0.0.0
SwitchC(config-router-bgp)#neighbor 12.1.1.2 remote-as 200
SwitchC(config-router-bgp)#neighbor 13.1.1.4 remote-as 200
SwitchC(config-router-bgp)#exit
```

The configurations of SwitchD are as following:

```
SwitchD(config)#router bgp 200
SwitchD(config-router-bgp)#network 13.0.0.0
SwitchD(config-router-bgp)#neighbor 12.1.1.2 remote-as 200
SwitchD(config-router-bgp)#neighbor 13.1.1.3 remote-as 200
SwitchD(config-router-bgp)#exit
```

Presently, the connection between SwitchB and SwitchA is EBGP, and other connections with SwitchC and SwitchD are IBGP. SwitchB and SwitchD may have BGP connection without physical connection. But there is a precondition that these two switches must have reachable route to each other. This route can be attained through static route or IGP.

5.5.3.2 Examples 2: configure BGP aggregation

In this sample, configure route aggregation. Firstly, enable command redistribute to redistribute static route to BGP route table:

```
SwitchB(config)#ip route 193.0.0.0/24 11.1.1
```

```
SwitchB(config)#router bgp 100
```

```
SwitchB(config-router-bgp)#redistribute static
```

When there is at least one route affiliated to the specified range, the following configuration will create an aggregation route in the BGP route table. The aggregation route will be regarded as the AS from itself. More detailed route information about 193.0.0.0 will be announced.

```
SwitchB(config)#router bgp 100
```

```
SwitchB(config-router-bgp)#aggregate 193.0.0.0/16
```

At the same time, the aggregation command above can be modified as following, then this switch only announce aggregation route 193.0.0.0 and forbid to announce more specified route to all the neighbors.

```
SwitchB(config-router-bgp)#aggregate 193.0.0.0/16 summary-only
```

5.5.3.3 Examples 3: configure BGP community attributes

In the following sample, “route map set-community” is used for the outgoing update to neighbor 16.1.1.6. By accessing to route in table 1 to configure special community value to “1111”, other can be announced normally.

```
Switch(config)#router bgp 100
```

```
Switch(config-router-bgp)#neighbor 16.1.1.6 remote-as 200
```

```
Switch(config-router-bgp)#neighbor 16.1.1.6 route-map set-community out
```

```
Switch(config-router-bgp)#exit
```

```
Switch(config)#route-map set-community permit 10
```

```
Switch(config-route-map)#match address 1
```

```
Switch(config-route-map)#set community 1111
```

```
Switch(config-route-map)#exit
```

```
Switch(config)#route-map set-community permit 20
```

```
Switch(config-route-map)#match address 2
```

```
Switch(config-route-map)#exit
```

```
Switch(config)#access-list 1 permit 11.1.0.0 0.0.255.255
```

```
Switch(config)#access-list 2 permit 0.0.0.0 255.255.255.255
```

```
Switch(config)#exit
```

```
Switch#clear ip bgp 16.1.1.6 soft out
```

In the following sample, configure the MED local preference of the routes from neighbor 16.1.1.6 selectively according to the route community value. All the routes that match the

community list will set MED as 2000, community list com1 permits the route with community value “100 200 300” or “900 901” to pass. This route may have other community attributes. All the routes that pass community list com2 will set the local preference as 500. But the route that can't pass both com1 and com2 will be rejected.

```
Switch(config)#router bgp 100
Switch(config-router-bgp)#neighbor 16.1.1.6 remote-as 200
Switch(config-router-bgp)#neighbor 16.1.1.6 route-map match-community in
Switch(config-router-bgp)#exit
Switch(config)#route-map match-community permit 10
Switch(config-route-map)#match community com1
Switch(config-route-map)#set metric 2000
Switch(config-route-map)#exit
Switch(config)#route-map match-community permit 20
Switch(config-route-map)#match community com2
Switch(config-route-map)#set local-preference 500
Switch(config-route-map)#exit
Switch(config)#ip community-list com1 permit 100 200 300
Switch(config)#ip community-list com1 permit 900 901
Switch(config)#ip community-list com2 permit 88
Switch(config)#ip community-list com2 permit 90
Switch(config)#exit
Switch#clear ip bgp 16.1.1.6 soft out
```

5.5.3.4 Examples 4: configure BGP confederation

The following is the configuration of an AS. As the picture illustrated, SwitchB and SwitchC establish IBGP connection. SwitchD is affiliated to AS 20. SwitchB and SwitchC establish EBGP of inner AS confederation. AS10 and AS20 form AS confederation with the AS number AS200; SwitchA belongs to AS100, SwitchB may create EBGP connection by AS200.

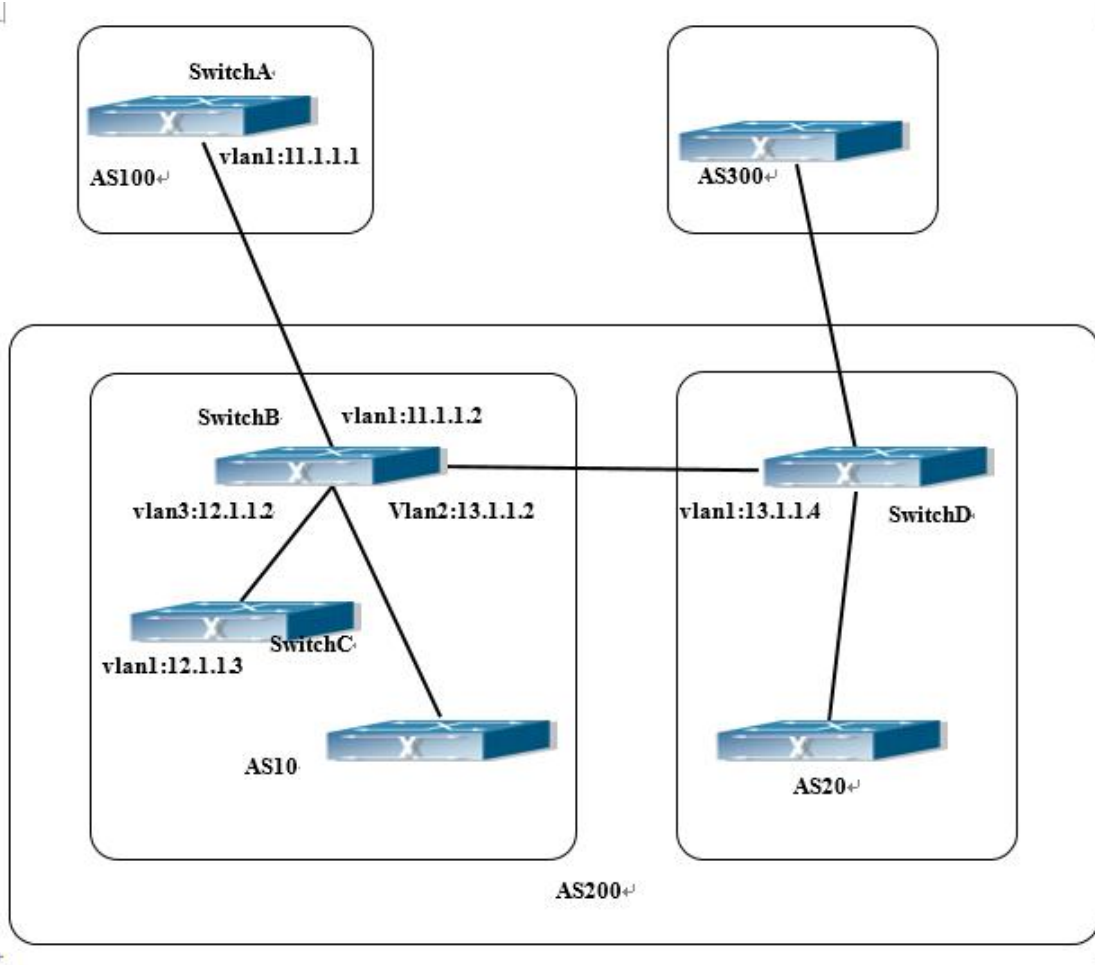

Figure 4- 10 Confederation configuring topology

The configurations are as following:

SwitchA:

```
SwitchA(config)#router bgp 100
SwitchA(config-router-bgp)#neighbor 11.1.1.2 remote-as 200
```

SwitchB:

```
SwitchB(config)#router bgp 10
SwitchB(config-router-bgp)#bgp confederation identifier 200
SwitchB(config-router-bgp)#bgp confederation peers 20
SwitchB(config-router-bgp)#neighbor 12.1.1.3 remote-as 10
SwitchB(config-router-bgp)#neighbor 13.1.1.4 remote-as 20
SwitchB(config-router-bgp)#neighbor 11.1.1.1 remote-as 100
```

SwitchC:

```
SwitchC(config)#router bgp 10
SwitchC(config-router-bgp)#bgp confederation identifier 200
SwitchC(config-router-bgp)#bgp confederation peers 20
SwitchC(config-router-bgp)#neighbor 12.1.1.2 remote-as 10
```

SwitchD:

```
SwitchD(config)#router bgp 20
SwitchD(config-router-bgp)#bgp confederation identifier 200
SwitchD(config-router-bgp)#bgp confederation peers 10
SwitchD(config-router-bgp)#neighbor 13.1.1.2 remote-as 10
```

5.5.3.5 Examples 5: configure BGP route reflector

The following is the configuration of a route reflector. As the picture illustrated, SwitchA, SwitchB, SwitchC, SwitchD, SWE, SWF and SWG establish IBGP connection which is affiliated to AS100. SwitchC creates EBGP connection with AS200. SwitchA creates EBGP connection with AS300. SwitchC, SwitchD and SWG make route reflectors.

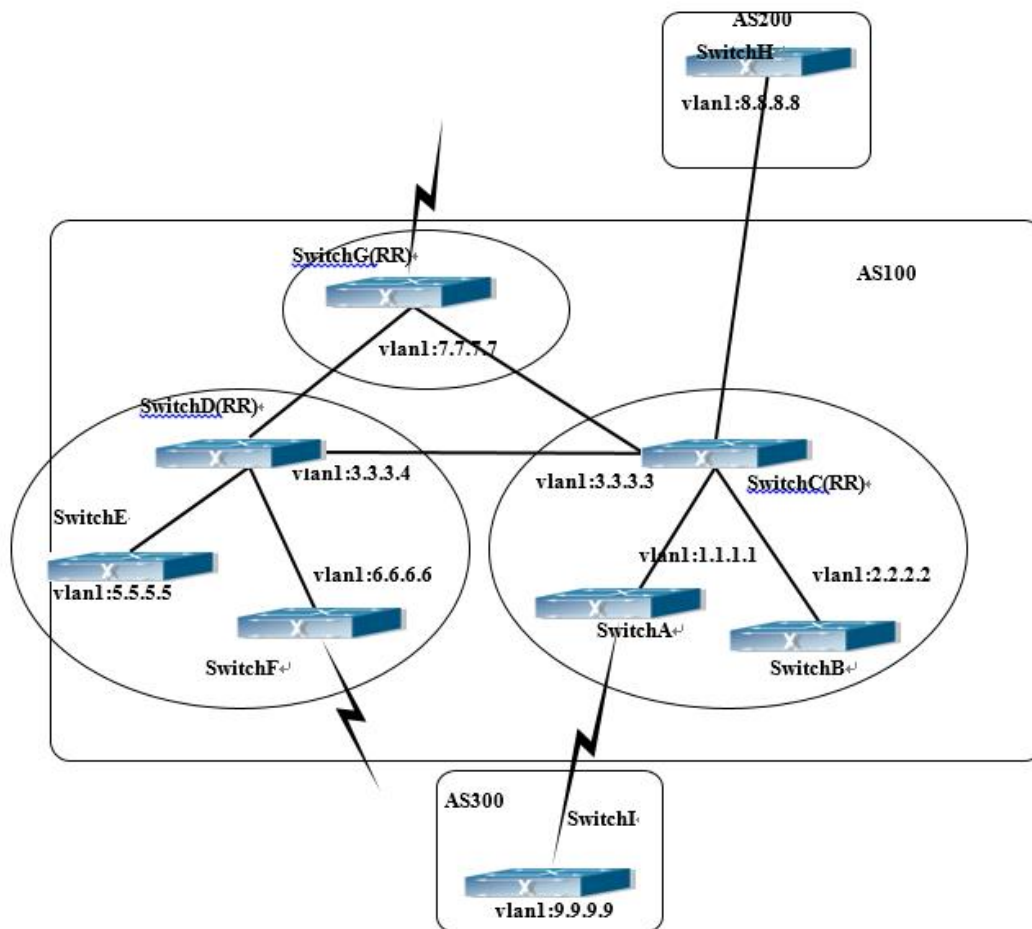

Figure 4- 11 the Topological Map of Route Reflector

The configurations are as following:

The configurations of SwitchC:

```
SwitchC(config)#router bgp 100
SwitchC(config-router-bgp)#neighbor 1.1.1.1 remote-as 100
SwitchC(config-router-bgp)#neighbor 1.1.1.1 route-reflector-client
SwitchC(config-router-bgp)#neighbor 2.2.2.2 remote-as 100
```

```
SwitchC(config-router-bgp)#neighbor 2.2.2.2 route-reflector-client
SwitchC(config-router-bgp)#neighbor 7.7.7.7 remote-as 100
SwitchC(config-router-bgp)#neighbor 3.3.3.4 remote-as 100
SwitchC(config-router-bgp)#neighbor 8.8.8.8 remote-as 200
```

The configurations of SwitchD:

```
SwitchD(config)#router bgp 100
SwitchD(config-router-bgp)#neighbor 5.5.5.5 remote-as 100
SwitchD(config-router-bgp)#neighbor 5.5.5.5 route-reflector-client
SwitchD(config-router-bgp)#neighbor 6.6.6.6 remote-as 100
SwitchD(config-router-bgp)#neighbor 6.6.6.6 route-reflector-client
SwitchD(config-router-bgp)#neighbor 3.3.3.3 remote-as 100
SwitchD(config-router-bgp)#neighbor 7.7.7.7 remote-as 100
```

The configurations of SwitchA:

```
SwitchA(config)#router bgp 100
SwitchA(config-router-bgp)#neighbor 1.1.1.2 remote-as 100
SwitchA(config-router-bgp)#neighbor 9.9.9.9 remote-as 300
```

The SwitchA at this time needn't to create IBGP connection with all the switches in the AS100 and could receive BGP route from other switches in the AS.

5.5.3.6 Examples 6: configure MED of BGP

The following is the configuration of a MED. As illustrated, SwitchA is affiliated to AS100, SwitchB is affiliated to AS400, SwitchC and SwitchD belong to AS300.

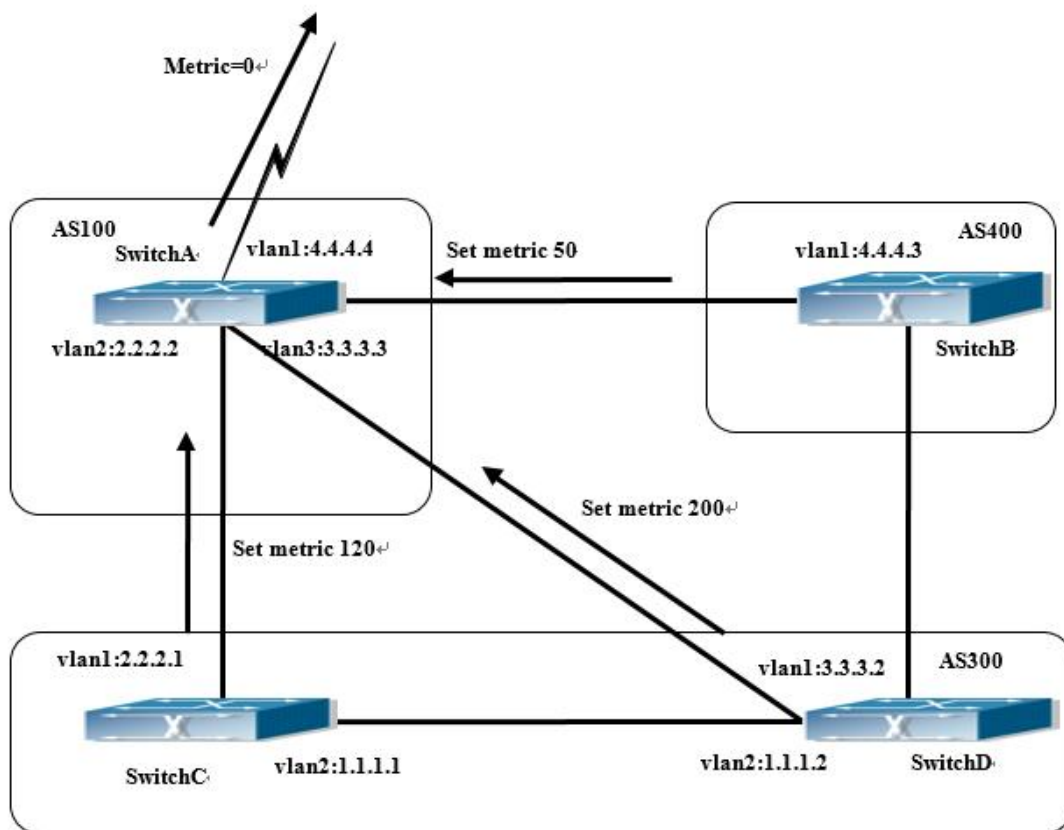

Figure 4- 12 MED Configuring Topological Map

The configurations of SwitchA:

```
SwitchA(config)#router bgp 100
SwitchA(config-router-bgp)#neighbor 2.2.2.1 remote-as 300
SwitchA(config-router-bgp)#neighbor 3.3.3.2 remote-as 300
SwitchA(config-router-bgp)#neighbor 4.4.4.3 remote-as 400
```

The configurations of SwitchC:

```
SwitchC(config)#router bgp 300
SwitchC (config-router-bgp)#neighbor 2.2.2.2 remote-as 100
SwitchC (config-router-bgp)#neighbor 2.2.2.2 route-map set-metric out
SwitchC (config-router-bgp)#neighbor 1.1.1.2 remote-as 300
SwitchC (config-router-bgp)#exit
SwitchC (config)#route-map set-metric permit 10
SwitchC (Config-Router-RouteMap)#set metric 120
```

The configurations of SwitchD

```
SwitchD (config)#router bgp 300
SwitchD (config-router-bgp)#neighbor 3.3.3.3 remote-as 100
SwitchD (config-router-bgp)#neighbor 3.3.3.3 route-map set-metric out
SwitchD (config-router-bgp)#neighbor 1.1.1.1 remote-as 300
SwitchD (config-router-bgp)#exit
```



```
SwitchD (config)#route-map set-metric permit 10
SwitchD (Config-Router-RouteMap)#set metric 200
```

The configurations of SwitchB

```
SwitchB (config)#router bgp 400
SwitchB (config-router-bgp)#neighbor 4.4.4.4 remote-as 100
SwitchB (config-router-bgp)#neighbor 4.4.4.4 route-map set-metric out
SwitchB (config-router-bgp)#exit
SwitchB (config)#route-map set-metric permit 10
SwitchB (Config-Router-RouteMap)#set metric 50
```

After the configuration above, SwitchB, SwitchC and SwitchD are assumed to send a route 12.0.0.0 to SwitchA. According to the comparison of BGP route strategy; there is an assumption that the routes sent by the three switches above have the same attribute value before the comparison of metric attribute. At this time, the route with lower value is the better route. But the comparison of metric attribute will only be done with the routes from the same AS. For SwitchA, the routes passed SwitchC are preferable to the one passed SwitchD. Because SwitchC and SwitchB are not located in the same AS, the SwitchA will not do metric comparison between the two switches. If the metric comparison between different AS is needed, the command "bgp always-compare-med" will be used. If this command is configured, the routes passed SwitchB are the best to SwitchA. At this time, the following command may be added on SwitchA:

```
SwitchA (config-router-bgp)#bgp always-compare-med
```

5.5.3.7 Examples 7: example of BGP VPN

For the configuration of MPLS VPN, BGP is part of the core routing system and it is also an important utility to support ILM and FTN entries on the edge devices. For switch, the BGP protocol together with the LDP protocol, constructs the foundation of the MPLS VPN application. The LDP protocol works at the WLAN side and for the routers which are not on the edge of the network, the BGP protocol does not function.

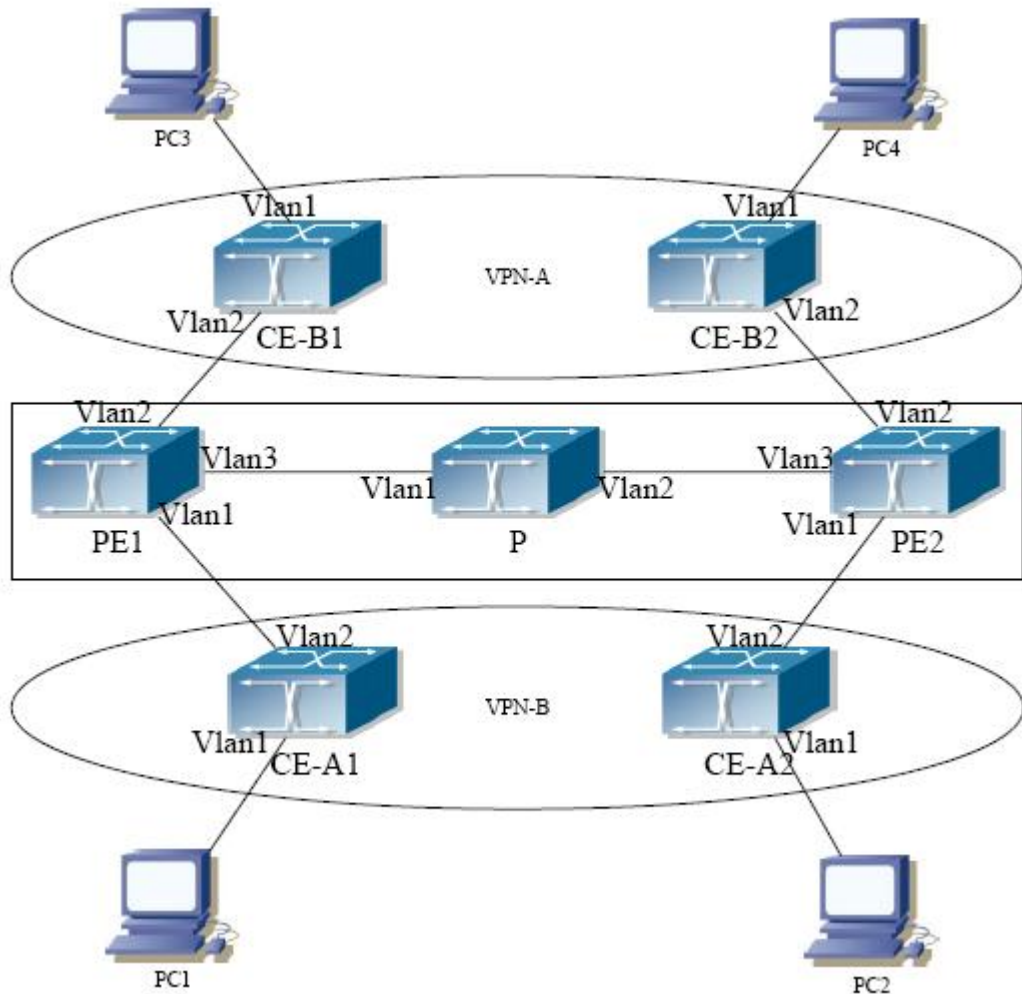

Figure 4- 13 Example of MPLS VPN

As the figure shows, for a typical MPLS VPN application, the public network region consists of PE1, P and PE2, which MPLS is applied for packet transmission. VPN-A consists of CE-A1 and CE-A2, and VPN-B consists of CE-B1 and CE-B2. These two VPNs are isolated from each other. PE1 and PE2 are edge routers which are provided by the operators. CE-A1, CE-A2, CE-B1 and CE-B2 are the access switches on the user side. PC1-PC4 indicate the network users. BGP runs at both the public and private network region. For the public network region, VPN routing should be supported and the LOOPBACK interface should be used for connections.

The sample configurations are listed as below.

Configurations on CE-A1:

```
CE-A1#config
CE-A1(config)#interface vlan 2
CE-A1(config-if-Vlan2)#ip address 192.168.101.2 255.255.255.0
CE-A1(config-if-Vlan2)#exit
CE-A1(config)#interface vlan 1
CE-A1(config-if-Vlan2)#ip address 10.1.1.1 255.255.255.0
CE-A1(config-if-Vlan2)#exit
CE-A1(config)#router bgp 60101
```

```
CE-A1(config-router)#neighbor 192.168.101.1 remote-as 100
CE-A1(config-router)#exit
```

Configurations on CE-A2: .

```
CE-A2#config
CE-A2(config)#interface vlan 2
CE-A2(config-if-Vlan2)#ip address 192.168.102.2 255.255.255.0
CE-A2(config-if-Vlan2)#exit
CE-A2(config)#interface vlan 1
CE-A2(config-if-Vlan2)#ip address 10.1.2.1 255.255.255.0
CE-A2(config-if-Vlan2)#exit
CE-A2(config)#router bgp 60102
CE-A2(config-router)#neighbor 192.168.102.1 remote-as 100
CE-A2(config-router)#exit
```

Configurations on CE-B1: .

```
CE-B1#config
CE-B1(config)#interface vlan 2
CE-B1(config-if-Vlan2)#ip address 192.168.201.2 255.255.255.0
CE-B1(config-if-Vlan2)#exit
CE-B1(config)#interface vlan 1
CE-B1(config-if-Vlan2)#ip address 20.1.1.1 255.255.255.0
CE-B1(config-if-Vlan2)#exit
CE-B1(config)#router bgp 60201
CE-B1(config-router)#neighbor 192.168.201.1 remote-as 100
CE-B1(config-router)#exit
```

Configurations on CE-BE2: .

```
CE-B2#config
CE-B2(config)#interface vlan 2
CE-B2(config-if-Vlan2)#ip address 192.168.202.2 255.255.255.0
CE-B2(config-if-Vlan2)#exit
CE-B2(config)#interface vlan 1
CE-B2(config-if-Vlan2)#ip address 20.1.2.1 255.255.255.0
CE-B2(config-if-Vlan2)#exit
CE-B2(config)#router bgp 60202
CE-B2(config-router)#neighbor 192.168.202.1 remote-as 100
CE-B2(config-router)#exit
```

Configurations on PE1:

```
PE1#config
PE1(config)#ip vrf VRF-A
PE1(config-vrf)#rd 100:10
PE1(config-vrf)#route-target both 100:10
```

```
PE1(config-vrf)#exit
PE1(config)#ip vrf VRF-B
PE1(config-vrf)#rd 100:20
PE1(config-vrf)#route-target both 100:20
PE1(config-vrf)#exit
PE1(config)#interface vlan 1
PE1(config-if-Vlan1)#ip vrf forwarding VRF-A
PE1(config-if-Vlan1)#ip address 192.168.101.1 255.255.255.0
PE1(config-if-Vlan1)#exit
PE1(config)#interface vlan 2
PE1(config-if-Vlan2)#ip vrf forwarding VRF-B
PE1(config-if-Vlan2)#ip address 192.168.201.1 255.255.255.0
PE1(config-if-Vlan2)#exit
PE1(config)#interface vlan 3
PE1(config-if-Vlan3)#ip address 202.200.1.2 255.255.255.0
PE1(config-if-Vlan3)#label-switching
PE1(config-if-Vlan3)#exit
PE1(config)#interface loopback 1
PE1(Config-if-Loopback1)# ip address 200.200.1.1 255.255.255.255
PE1(config-if-Vlan3)#exit
PE1(config)#router bgp 100
PE1(config-router)#neighbor 200.200.1.2 remote-as 100
PE1(config-router)#neighbor 200.200.1.2 update-source 200.200.1.1
PE1(config-router)#address-family vpnv4 unicast
PE1(config-router-af)#neighbor 200.200.1.2 activate
PE1(config-router-af)#exit-address-family
PE1(config-router)#address-family ipv4 vrf VRF-A
PE1(config-router-af)# neighbor 192.168.101.2 remote-as 60101
PE1(config-router-af)#exit-address-family
PE1(config-router)#address-family ipv4 vrf VRF-B
PE1(config-router-af)# neighbor 192.168.201.2 remote-as 60201
PE1(config-router-af)#exit-address-family
```

Configurations on PE2:

```
PE2#config
PE2(config)#ip vrf VRF-A
PE2(config-vrf)#rd 100:10
PE2(config-vrf)#route-target both 100:10
PE2(config-vrf)#exit
PE2(config)#ip vrf VRF-B
PE2(config-vrf)#rd 100:20
PE2(config-vrf)#route-target both 100:20
PE2(config-vrf)#exit
PE2(config)#interface vlan 1
```

```
PE2(config-if-Vlan1)#ip vrf forwarding VRF-A
PE2(config-if-Vlan1)#ip address 192.168.102.1 255.255.255.0
PE2(config-if-Vlan1)#exit
PE2(config)#interface vlan 2
PE2(config-if-Vlan2)#ip vrf forwarding VRF-B
PE2(config-if-Vlan2)#ip address 192.168.202.1 255.255.255.0
PE2(config-if-Vlan2)#exit
PE2(config)#interface vlan 3
PE2(config-if-Vlan3)#ip address 202.200.2.2 255.255.255.0
PE2(config-if-Vlan3)#label-switching
PE2(config-if-Vlan3)#exit
PE2(config)#interface loopback 1
PE2(Config-if-Loopback1)# ip address 200.200.1.2 255.255.255.255
PE2(config-if-Vlan3)#exit
PE2(config)#router bgp 100
PE2(config-router)#neighbor 200.200.1.1 remote-as 100
PE2(config-router)#address-family vpnv4 unicast
PE2(config-router-af)#neighbor 200.200.1.1 activate
PE2(config-router-af)#exit-address-family
PE2(config-router)#address-family ipv4 vrf VRF-A
PE2(config-router-af)# neighbor 192.168.102.2 remote-as 60102
PE2(config-router-af)#exit-address-family
PE2(config-router)#address-family ipv4 vrf VRF-B
PE2(config-router-af)# neighbor 192.168.202.2 remote-as 60202
PE2(config-router-af)#exit-address-family
```

The sample configurations which are listed above is the most typical one. To enable communication between VRF, the route-target should be modified. And if the BGP AS number duplicates for the ends, the “**neighbor <ip-addr> as-override**” command should be configured to avoid the duplication of AS numbers.

Also, only BGP related configuration are listed above, to run LDP on the public network region, please refer to the LDP configuration sample.

5.5.4 BGP Troubleshooting

In the process of configuring and implementing BGP protocol, physical connection, configuration false probably leads to BGP protocol doesn't work. Therefore, the customers should give their attention to points as follow:

- ☞ First of all, to ensure correct physical connection;
- ☞ Secondly, to ensure interface and link protocol are UP (execute **show interface** instruction);
- ☞ And startup BGP protocol (use **router bgp** command), configure affiliated IBGP and EBGP neighbors (use **neighbor remote-as** command).

- ☞ Notice BGP protocol itself can't detect route, needs to import other routes to create BGP route. Only it enables these routes to announce IBGP and EBGP neighbors by importing routes. Direct-link routes, static route, and IGP route (RIP and OSPF) are included in these imported routes. **network** and **redistribute (BGP)** command are the ways of imported routes.
- ☞ For BGP, pay attention to the difference between the behaviors of IBGP and EBGP.
- ☞ After configuration finishes, the command of **show ip bgp summary** can be used to observe neighbor's connections, so that all of the neighbors keep BGP connection situation. And use **show ip bgp** command to observe BGP routing table.
- ☞ If BGP routing problem still can't be solved by debugging, please use debug instructions like **debug ip bgp** packet/events etc, and copy DEBUG information in 3 minutes, then send them to our Technology Service Center.

5.6 IPv4 Black Hole Routing

5.6.1 Introduction to Black Hole Routing

Black Hole Routing is a special kind of static routing which drops all the datagrams that match the routing rule.

5.6.2 IPv4 Black Hole Routing Configuration Task

1. Configure IPv4 Black Hole Routing

1. Configure IPv4 Black Hole Routing

Command	Explanation
Global Configuration Mode	
ip route {<ip-prefix> <mask> <ip-prefix>/<prefix-length> null0 [<distance>] no ip route {<ip-prefix> <mask> <ip-prefix>/<prefix-length> null0	To configure the static Black Hole Routing. The no form of this command will remove the specified Black Hole Routing configuration.

5.6.3 Black Hole Routing Configuration Examples

Example 1: IPv4 Black Hole Routing function.

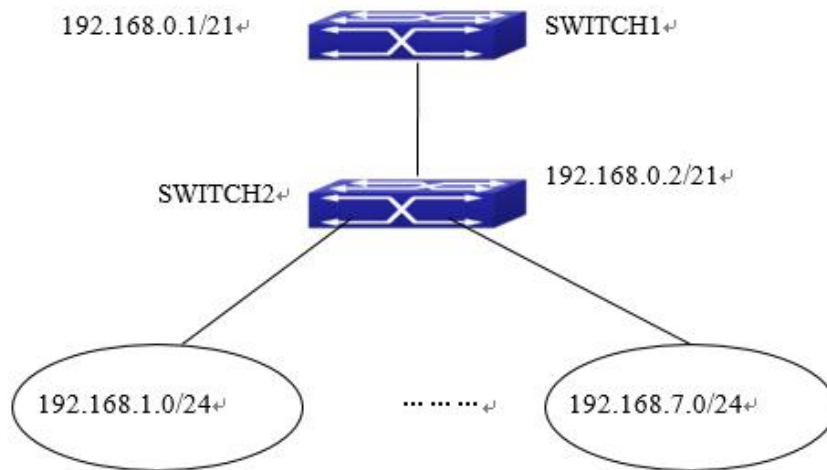

Figure 4- 14 IPv4 Black Hole Routing Configuration Example

As it is shown in the figure, in Switch 2, eight in all interfaces are configured as Layer 3 VLAN interfaces for access interfaces. The network addresses are 192.168.1.0/24 ~ 192.268.7.0/24. A default routing is configured on Switch 2 to connect to Switch 1. And a backward default routing is configured on Switch 1 to Switch 2, whose network address is 192.168.0.0/21. Commonly, this configuration will work well. However, if one of the Layer 3 interfaces in Switch 2 goes down, for example, the interface belonged to 192.168.1.0/24. When datagrams arrives at VLAN1 in Switch 2, there will be no routing rules for these datagrams. The switch then will forward these datagrams according to the default routing, back to Switch 1. When Switch 1 receives these datagrams, it will forward them back to Switch 2. Thus, loopback exists. To solve this problem, Black Hole Routing can be introduced on Switch 2.

```
ip route 192.168.0.0/21 null0 50
```

Then Switch 2 will drop the datagrams from interface VLAN1 that match the Black Hole Routing rule. And loopback routing is prevented.

Configuration steps are listed as below:

```
Switch#config
```

```
Switch(config)#ip route 192.168.0.0/21 null0 50
```

5.6.4 Black Hole Routing Troubleshooting

When configuring the Black Hole Routing function, the configuration may not work due to some reasons such as incorrect network address mask, and incorrect management distance. Attention should be paid to the following items:

- ✎ IPv6 should be enabled before IPv6 Black Hole Routing can work.
- ✎ It is suggested that the length of the network address mask should be longer than that of normal routing configuration, in order to prevent the Black Hole Routing from intervening other routing configuration.

☞ When the network address mask of Black Hole Routing configuration is the same with some other configuration, it is suggested that the distance of Black Hole Routing is set lower.

For problems that cannot be fixed through above methods, please issue the command `show ip route distance` and `show ip route fib`, and `show l3`. And copy and paste the output of the commands, and send to the technical service center of our company.

5.7 GRE

5.7.1 Introduction to GRE Tunnel

GRE (General Routing-protocol Encapsulation) was referred to IETF by Cisco and Net-smiths companies in 1994, in RFC1701 and RFC1702. At present, the network devices of the most manufacturers support the GRE tunnel protocol. GRE set how to encapsulate a kind of network protocol in other kind of network protocol. The GRE tunnel is defined by the source IP address and the destination IP address of two ends, it allows that users can use IP packets to encapsulate IP, IPX, AppleTalk packets, and supports all routing protocols (such as RIP2, OSPF, etc). By GRE, users can use the public IP network to connect IPX network, AppleTalk network, and use the reserved address to connect through the internet work, or hide the IP address of the corporation network to the public network. GRE only provides the encapsulation of the data packets, and has no encryption function to avoid the network interception and attack. Therefore, it is used with IPsec usually in the actual environment, and IPsec provides the data encryption to supply very good security for users.

The most use of GRE protocol: the internal protocol encapsulation and the private address encapsulation of the enterprise. In our nation, the enterprise network almost adopts TCP/IP protocol, so there are fewer requirements to the internal protocol encapsulation. The enterprise use GRE almost for encapsulating the private address .In our switches, the GRE is used mainly for the transition of the network protocol (include IPv6 OVER IPv4 and IPv4 OVER IPv6).

RFC1701, 1702, 2784 are referred for the implement.

5.7.2 GRE Tunnel Basic Configuration

GRE Tunnel Configuration Task List:

1. Configure tunnel mode
 - 1) Configure tunnel mode as GREv4 tunnel
2. Configure the source address and the destination address of GRE tunnel
 - 1) Configure the source address as the IPv4 address for GRE tunnel
 - 2) Configure the destination address as the IPv4 address for GRE tunnel
3. Configure the interface address of GRE tunnel
 - 1) Configure the IPv4 address of GRE tunnel interface
 - 2) Configure the IPv6 address of GRE tunnel interface

4. Configure the egress interface of the static route as GRE tunnel
 - 1) Configure the egress interface of the IPv4 static route to GRE tunnel
 - 2) Configure the egress interface of the IPv6 static route to GRE tunnel

1. Configure tunnel mode

Command	Explanation
Tunnel interface configuration mode	
tunnel mode gre ip no tunnel mode	Configure the tunnel mode as GREv4 tunnel. After the data packet is encapsulated with GRE, it has a head of IPv4 packets, and passes the IPv4 network.

2. Configure the source address and the destination address of GRE tunnel

Command	Explanation
Tunnel interface configuration mode	
tunnel source <ipv4-address> no tunnel source	Configure the source address as the IPv4 address for GRE tunnel.
tunnel destination <ipv4-address> no tunnel destination	Configure the destination address as the IPv4 address for GRE tunnel.

Command	Explanation
Tunnel interface configuration mode	
tunnel source {<ipv6-address> <ipv4-address>} no tunnel source	Configure the source address as the IPv6 or IPv4 address for GRE tunnel.
tunnel destination {<ipv6-address> <ipv4-address>} no tunnel destination	Configure the destination address as the IPv6 or IPv4 address for GRE tunnel.

3. Configure the interface address of GRE tunnel

Command	Explanation
Tunnel interface configuration mode	
ip address <ipv4-address> <mask> no ip address <ipv4-address> <mask>	Configure the IPv4 address of GRE tunnel interface.
ipv6 address <ipv6-address/prefix> no ipv6 address <ipv6-address/prefix>	Configure the IPv6 address of GRE tunnel interface.

4. Configure the egress interface of the static route as GRE tunnel

Command	Explanation
Global Mode	
ip route <ipv4-address/mask> tunnel <ID> no ip route <ipv4-address/mask> tunnel <ID>	Configure the egress interface of the IPv4 static route to GRE tunnel.
ipv6 route <ipv6-address/prefix> tunnel <ID> no ipv6 route <ipv6-address/prefix> tunnel <ID>	Configure the egress interface of the IPv6 static route to GRE tunnel.

5.7.3 Example of GRE Tunnel

The Typical Example of GRE Tunnel:

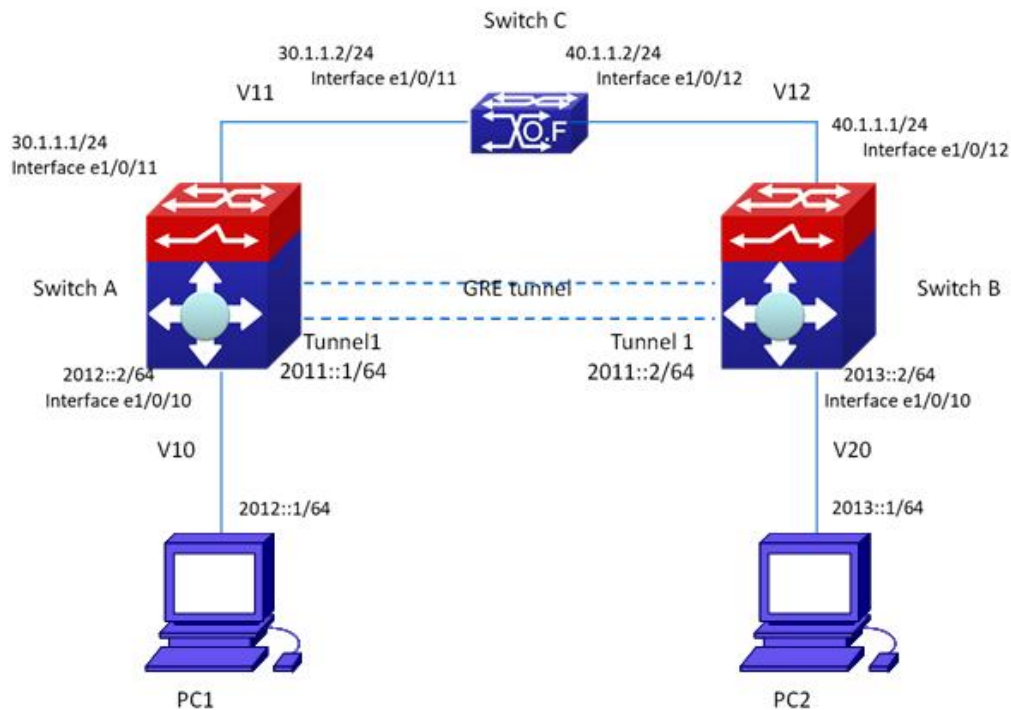

Figure 4- 15 the typical network of IPv6 over IPv4 GRE tunnel character

Configuration summary:

- ✎ Configure IPv4 network, and ensure IPv4 connectivity.
- ✎ Configure the tunnel interface, and the interface that connect PC.
- ✎ Configure the tunnel parameters and enable the tunnel interface.
- ✎ Enable OSPF route protocol to forward the data between PC1 and PC2 through the tunnel.

Configuration steps

Instruction: the topology environment of this chapter may be different to the actual

environment. To ensure the effect of the configuration, please make sure the current configuration of the device does not conflict with the following configuration.

(1) The configuration of device A

1. The configuration step

- ☞ Create the interface VLAN 11 and its address.

```
SwitchA(config)#vlan 11
SwitchA(config-vlan11)#switchport interface ethernet 1/0/11
SwitchA(config-vlan11)#exit
SwitchA(config)#interface vlan 11
SwitchA(config-if-vlan11)#ip address 30.1.1.1/24
```

- ☞ Configure the IPv4 static route to switch B from interface Vlan11.

```
SwitchA(config)#ip route 40.1.1.1/24 30.1.1.2
```

- ☞ Configure tunnel interface: source, destination and type. After the tunnel is enabled, its source address and destination address can not be modified except the source address as the layer 3 interface.

```
SwitchA(config)#interface tunnel 1
SwitchA(config-if-tunnel1)# tunnel source 30.1.1.1
SwitchA(config-if-tunnel1)# tunnel destination 40.1.1.1
SwitchA(config-if-tunnel1)# tunnel mode gre ip
SwitchA#show gre tunnel
```

name	mode	source	destination
Tunnel1	gre ip	30.1.1.1	40.1.1.1

The configuration of GRE tunnel is successful.

- ☞ Configure the IPv6 address of the tunnel interface. Only one interface address can be configured for the tunnel interface, and this limitation will also be used to other tunnels, such as configure tunnel, 6to4, isatap.

Notice: the tunnel must stays in active state when configuring IPv4 address, but configure IPv6 address is different to IPv4 address.

```
SwitchA (config-if-tunnel1)#ipv6 address 2011::1/64
```

- ☞ Configure the interface VLAN10 and its address.

```
SwitchA(config)#vlan 10
SwitchA(config-vlan10)#switchport interface ethernet 1/0/10
SwitchA(config-vlan10)#exit
SwitchA(config)#interface vlan 10
SwitchA(config-if-vlan10)# ipv6 address 2012::2/64
SwitchA(config-if-vlan10)#exit
```

- ☞ Configure OSPF routing protocol.

```
SwitchA(config)#router ospf
SwitchA(config-router)#router-id 1.1.1.1
SwitchA(config-router)#network 30.1.1.1/24 area 0
SwitchA(config-router)#exit
```

(2) The configuration of device B

1. The configuration step

- ☞ Create the interface VLAN 12 and its address.

```
SwitchA(config)#vlan 12
SwitchA(config-vlan12)#switchport interface ethernet 1/0/12
SwitchA(config-vlan12)#exit
SwitchA(config)#interface vlan 12
SwitchA(config-if-vlan12)#ip address 40.1.1.1/24
SwitchA(config-if-vlan12)#exit
SwitchA(config)#
```

- ☞ Configure the IPv4 static route to Switch A from interface Vlan12.

```
SwitchA(config)#ip route 30.1.1.1/24 40.1.1.2
```

- ☞ Configure tunnel interface: source, destination and type.

```
SwitchA(config)#interface tunnel 1
SwitchA(config-if-tunnel1)# tunnel source 40.1.1.1
SwitchA(config-if-tunnel1)# tunnel destination 30.1.1.1
SwitchA(config-if-tunnel1)# tunnel mode gre ip
SwitchA#show gre tunnel
```

name	mode	source	destination
Tunnell	gre ip	40.1.1.1	30.1.1.1

The configuration of GRE tunnel is successful.

- ☞ Configure the IPv6 address of the tunnel interface. To run OSPF routing protocol, the interface address must be configured.

```
SwitchA (config-if-tunnel1)#ipv6 address 2011::2/64
```

- ☞ Configure the interface VLAN20 and its address.

```
SwitchA(config)#vlan 20
SwitchA(config-vlan20)#switchport interface ethernet 1/0/10
SwitchA(config-vlan20)#exit
SwitchA(config)#interface vlan 20
SwitchA(config-if-vlan20)# ipv6 address 2013::2/64
SwitchA(config-if-vlan20)#exit
SwitchA(config)#
```

- ☞ Configure OSPF routing protocol.

```
SwitchA(config)#router ospf
SwitchA(config-router)#router-id 1.1.1.2
SwitchA(config-router)#network 40.1.1.0/24 area 0
SwitchA(config-router)#exit
SwitchA(config)#
```

(3) The configuration of device C

1. The configuration step

- ☞ Create the interface VLAN 11 and its address.

```
SwitchA(config)#vlan 11
SwitchA(config-vlan11)#switchport interface ethernet 1/0/11
```

```
SwitchA(config-vlan11)#exit
SwitchA(config)#interface vlan 11
SwitchA(config-if-vlan11)#ip address 30.1.1.2/24
```

- 👉 Create the interface VLAN 12 and its address

```
SwitchA(config)#vlan 12
SwitchA(config-vlan12)#switchport interface ethernet 1/0/12
SwitchA(config-vlan12)#exit
SwitchA(config)#interface vlan 12
SwitchA(config-if-vlan12)#ip address 40.1.1.2/24
SwitchA(config-if-vlan12)#exit
```

(4) The configuration of PC

- 👉 Configure the IP address of PC1 and the default gateway.
PC1: the IP address: 2012::1/64, the default gateway: 2012::2
PC2: the IP address: 2013::1/64, the default gateway: 2013::2

5.7.4 Example of GRE Tunnel Quotes Loopback Group

Introduction to loopback group

When the cards with different types are inserted to a device, implement the redirection between the different cards through loopback function, such as: the cards whether support GRE tunnel are inserted, so the GRE tunnel data received by the cards (do not support GRE tunnel) to be processed to the supporting GRE tunnel cards. A loopback group uses the (one or several) card's ports without any configuration. To increase the redirection bandwidth between the cards, join many ports in a loopback group to implement the load balance.

Example of GRE tunnel quotes loopback group

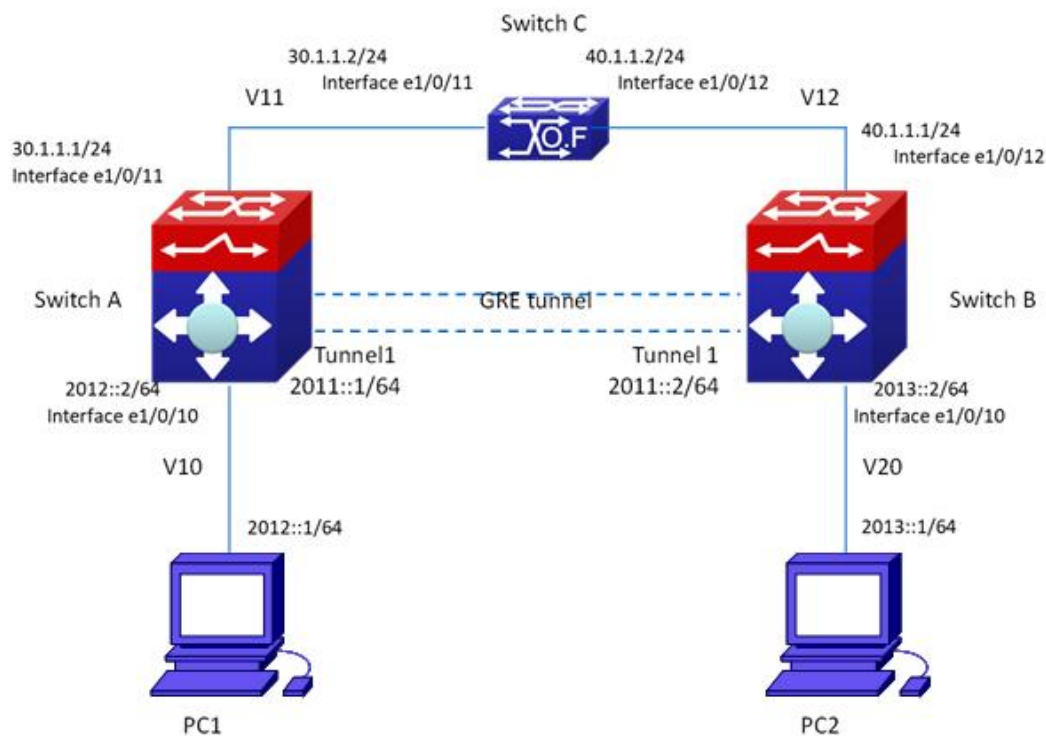

Figure 4- 16 GRE tunnel quotes loopback group topology

Introduction to loopback group topology

IPv4 network between SwitchA and SwitchB, PC1 and PC2 at IPv6 network, so PC1 must pass IPv4 network between SwitchA and SwitchB to communicate with PC2 through GRE tunnel. The cards with different types may be inserted to SwitchA, card 1 does not support GRE tunnel, card 3 supports GRE tunnel, so the data received by card 1 needs to be processed to card 3 through loopback group function.

Configuration summary:

- ✎ Configure IPv4 network, and ensure IPv4 connectivity.
- ✎ Configure the tunnel interface, and the interface that connect PC.
- ✎ Configure the tunnel parameters and enable the tunnel interface.
- ✎ Configure loopback group, join port 1/0/12 of the card 3 in this loopback group and enable the tunnel to quote this loopback group.
- ✎ Enable OSPF route protocol to forward the data between PC1 and PC2 through the tunnel.

Configuration steps

Instruction: the topology environment of this chapter may be different to the actual environment. To ensure the effect of the configuration, please make sure the current configuration of the device does not conflict with the following configuration.

(1) The configuration of device A

1. The configuration step

- ✎ Create the interface VLAN 11 and its address.
SwitchA(config)#vlan 11

```
SwitchA(config-vlan11)#switchport interface ethernet 1/0/11
SwitchA(config-vlan11)#exit
SwitchA(config)#interface vlan 11
SwitchA(config-if-vlan11)#ip address 30.1.1.1/24
```

- ☞ Configure the IPv4 static route to switch B from interface Vlan11.

```
SwitchA(config)#ip route 40.1.1.1/24 30.1.1.2
```

- ☞ Configure tunnel interface: source, destination and type.

```
SwitchA(config)#interface tunnel 1
SwitchA(config-if-tunnel1)# tunnel source 30.1.1.1
SwitchA(config-if-tunnel1)# tunnel destination 40.1.1.1
SwitchA(config-if-tunnel1)# tunnel mode gre ip
SwitchA#show gre tunnel
```

name	mode	source	destination
Tunnel1	gre ipv6	30.1.1.1	40.1.1.1

The configuration of GRE tunnel is successful.

- ☞ Configure the IPv6 address of the tunnel interface. To run OSPF routing protocol, the interface address must be configured.

```
SwitchA (config-if-tunnel1)#ipv6 address 2011::1/64
```

- ☞ Configure the interface VLAN10 and its address.

```
SwitchA(config)#vlan 10
SwitchA(config-vlan10)#switchport interface ethernet 1/0/10
SwitchA(config-vlan10)#exit
SwitchA(config)#interface vlan 10
SwitchA(config-if-vlan10)# ipv6 address 2012::2/64
SwitchA(config-if-vlan10)#exit
```

- ☞ Configure loopback group and enable the tunnel to quote this loopback group.

```
SwitchA (config)#loopback-group 1
SwitchA (config-if-ethernet1/0/12)#loopback-group 1
SwitchA (config-if-tunnel1)# loopback-group 1
```

- ☞ Configure OSPF routing protocol.

```
SwitchA(config)#router ospf
SwitchA(config-router)#router-id 1.1.1.1
SwitchA(config-router)#network 30.1.1.0/24 area 0
SwitchA(config-router)#exit
```

(2) The configuration of device B

1. The configuration step

- ☞ Create the interface VLAN 12 and its address.

```
SwitchA(config)#vlan 12
SwitchA(config-vlan12)#switchport interface ethernet 1/0/12
SwitchA(config-vlan12)#exit
SwitchA(config)#interface vlan 12
SwitchA(config-if-vlan11)#ip address 30.1.1.2/24
```

```
SwitchA(config-if-vlan12)#exit
```

```
SwitchA(config)#
```

- Configure the IPv4 static route to Switch A from interface Vlan12.

```
SwitchA(config)#ip route 30.1.1.1/24 40.1.1.2
```

- Configure tunnel interface: source, destination and type.

```
SwitchA(config)#interface tunnel 1
```

```
SwitchA(config-if-tunnel1)# tunnel source 40.1.1.1
```

```
SwitchA(config-if-tunnel1)# tunnel destination 30.1.1.1
```

```
SwitchA(config-if-tunnel1)# tunnel mode gre ip
```

```
SwitchA#show gre tunnel
```

name	mode	source	destination
Tunnel1	gre ipv6	40.1.1.1	30.1.1.1

The configuration of GRE tunnel is successful.

- Configure the IPv6 address of the tunnel interface. To run OSPF routing protocol, the interface address must be configured.

```
SwitchA (config-if-tunnel1)#ipv6 address 2011::2/64
```

- Configure the interface VLAN20 and its address.

```
SwitchA(config)#vlan 20
```

```
SwitchA(config-vlan20)#switchport interface ethernet 1/0/10
```

```
SwitchA(config-vlan20)#exit
```

```
SwitchA(config)#interface vlan 20
```

```
SwitchA(config-if-vlan20)# ipv6 address 2013::2/64
```

```
SwitchA(config-if-vlan20)#exit
```

```
SwitchA(config)#
```

- Configure OSPF routing protocol.

```
SwitchA(config)#router ospf
```

```
SwitchA(config-router)#router-id 1.1.1.2
```

```
SwitchA(config-router)#network 40.1.1.0/24 area 0
```

```
SwitchA(config-router)#exit
```

```
SwitchA(config)#
```

(3) The configuration of device C

1. The configuration step

- Create the interface VLAN 11 and its address.

```
SwitchA(config)#vlan 11
```

```
SwitchA(config-vlan11)#switchport interface ethernet 1/0/11
```

```
SwitchA(config-vlan11)#exit
```

```
SwitchA(config)#interface vlan 11
```

```
SwitchA(config-if-vlan11)#ip address 30.1.1.2/24
```

- Create the interface VLAN 12 and its address

```
SwitchA(config)#vlan 12
```

```
SwitchA(config-vlan12)#switchport interface ethernet 1/0/12
```

```
SwitchA(config-vlan12)#exit
```



```
SwitchA(config)#interface vlan 12
SwitchA(config-if-vlan12)#ip address 40.1.1.2/24
SwitchA(config-if-vlan12)#exit
```

(4) The configuration of PC

- ✎ Configure the IP address of PC1 and the default gateway.
PC1: the IP address: 2012::1/64, the default gateway: 2012::2
PC2: the IP address: 2013::1/64, the default gateway: 2013::2

5.7.5 GRE Tunnel Troubleshooting

If there is any problem happens when using GRE tunnel, please check whether the problem is caused by the following reasons:

- ✎ Check the configuration, whether the source and the destination addresses of the tunnel are correctly configured, whether the tunnel mode (`tunnel mode gre {ip | ipv6}`) is configured correctly.
- ✎ Check the static route that with the GRE tunnel interface as the next hop interface.
- ✎ Whether the connection is normal between the switches, use `debug gre {packet | event | all}` to check whether the switch receives and processes the GRE packets correctly.

5.8 ECMP

5.8.1 Introduction to ECMP

ECMP (Equal-cost Multi-path Routing) works in the network environment where there are many different links to arrive at the same destination address. If using the traditional routing technique, only a link can be used to send the data packets to the destination address, other links at the backup state or the invalidation state, and it needs some times to process the mutual switchover under the static routing environment. However, ECMP protocol can use multi-links under such network environment, it not only implements the load balance, increases the transport bandwidth, but also can completely backup the data transport of the invalidation links without delay and packet loss.

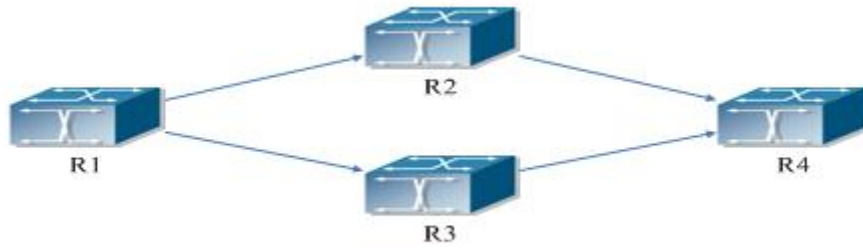

Figure 4- 15 the application environment of ECMP

As it is shown in the figure, there are two paths can be selected from R1 to R4, they are R1-R2-R4 and R1-R3-R4. If the route type and the cost are same, then it can forms two routes from R1 to R4, but the next hop is different. If two routes are selected as the best, then they form the equal-cost route.

5.8.2 ECMP Configuration Task List

1. Configure the max number of equal-cost route
2. Configure load-balance mode for port-group

1. Configure the max number of equal-cost route

Command	Explanation
Global mode	
maximum-paths <1-8> no maximum-paths	Configure the max number of equal-cost route.

2. Configure load-balance mode for port-group

Command	Explanation
Global Mode	
load-balance {dst-src-mac dst-src-ip dst-src-mac-ip }	Set load-balance for switch, it takes effect for port-group and ECMP function at the same time.

5.8.3 ECMP Typical Example

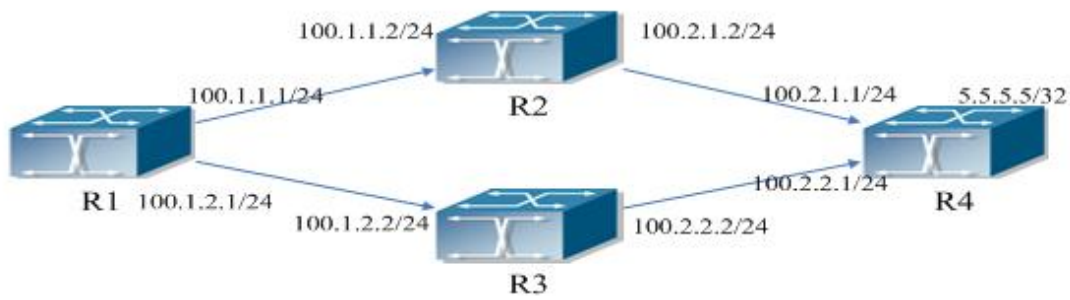

Figure 4- 16 the application environment of ECMP

As it is shown in the figure, the R1 connect to R2 and R3 with the interface address 100.1.1.1/24 and 100.1.2.1/24. The R2 and R3 connect to R1 with the interface address 100.1.1.2/24 and 100.1.2.2/24. The R4 connect to R2 and R3 with interface address 100.2.1.1/24 and 100.2.2.1/24. The R2 and R3 connect to R4 with the interface address 100.2.1.2/24, 100.2.2.2/24. The loopback address of R4 is 5.5.5.5/32.

5.8.3.1 Static Route Implements ECMP

```
R1(config)#ip route 5.5.5.5/32 100.1.1.2
```

```
R1(config)#ip route 5.5.5.5/32 100.1.2.2
```

On R1, show ip route, the following is displayed:

```
R1(config)#show ip route
```

Codes: K - kernel, C - connected, S - static, R - RIP, B - BGP

O - OSPF, IA - OSPF inter area

N1 - OSPF NSSA external type 1, N2 - OSPF NSSA external type 2

E1 - OSPF external type 1, E2 - OSPF external type 2

i - IS-IS, L1 - IS-IS level-1, L2 - IS-IS level-2, ia - IS-IS inter area

* - candidate default

```
C    1.1.1.1/32 is directly connected, Loopback1  tag:0
```

```
S    5.5.5.5/32 [1/0] via 100.1.1.2, Vlan100  tag:0
```

```
      [1/0] via 100.1.2.2, Vlan200  tag:0
```

```
C    100.1.1.0/24 is directly connected, Vlan100  tag:0
```

```
C    100.1.2.0/24 is directly connected, Vlan200 tag:0
```

```
C    127.0.0.0/8 is directly connected, Loopback  tag:0
```

```
Total routes are : 6 item(s)
```

5.8.3.2 OSPF Implements ECMP

R1 configuration:

```
R1(config)#interface Vlan100
```

```
R1(Config-if-Vlan100)# ip address 100.1.1.1 255.255.255.0
```

```
R1(config)#interface Vlan200
```

```
R1(Config-if-Vlan200)# ip address 100.1.2.1 255.255.255.0
R1(config)#interface loopback 1
R1(Config-if-loopback1)# ip address 1.1.1.1 255.255.255.255
R1(config)#router ospf 1
R1(config-router)# ospf router-id 1.1.1.1
R1(config-router)# network 100.1.1.0/24 area 0
R1(config-router)# network 100.1.2.0/24 area 0
```

R2 configuration:

```
R2(config)#interface Vlan100
R2(Config-if-Vlan100)# ip address 100.1.1.2 255.255.255.0
R2(config)#interface Vlan200
R2(Config-if-Vlan200)# ip address 100.2.1.2 255.255.255.0
R2(config)#interface loopback 1
R2(Config-if-loopback1)# ip address 2.2.2.2 255.255.255.255
R2(config)#router ospf 1
R2(config-router)# ospf router-id 2.2.2.2
R2(config-router)# network 100.1.1.0/24 area 0
R2(config-router)# network 100.2.1.0/24 area 0
```

R3 configuration:

```
R3(config)#interface Vlan100
R3(Config-if-Vlan100)# ip address 100.1.2.2 255.255.255.0
R3(config)#interface Vlan200
R3(Config-if-Vlan200)# ip address 100.2.2.2 255.255.255.0
R3(config)#interface loopback 1
R3(Config-if-loopback1)# ip address 3.3.3.3 255.255.255.255
R3(config)#router ospf 1
R3(config-router)# ospf router-id 3.3.3.3
R3(config-router)# network 100.1.2.0/24 area 0
R3(config-router)# network 100.2.2.0/24 area 0
```

R4 configuration:

```
R4(config)#interface Vlan100
R4(Config-if-Vlan100)# ip address 100.2.1.1 255.255.255.0
R4(config)#interface Vlan200
R4(Config-if-Vlan200)# ip address 100.2.2.1 255.255.255.0
R4(config)#interface loopback 1
R4(Config-if-loopback1)# ip address 5.5.5.5 255.255.255.255
R4(config)#router ospf 1
R4(config-router)# ospf router-id 4.4.4.4
R4(config-router)# network 100.2.1.0/24 area 0
R4(config-router)# network 100.2.2.0/24 area 0
```

On R1, show ip route, the following is displayed:

```
R1(config)#show ip route
```

```
Codes: K - kernel, C - connected, S - static, R - RIP, B - BGP
```

```
O - OSPF, IA - OSPF inter area
```

```
N1 - OSPF NSSA external type 1, N2 - OSPF NSSA external type 2
```

```
E1 - OSPF external type 1, E2 - OSPF external type 2
```

```
i - IS-IS, L1 - IS-IS level-1, L2 - IS-IS level-2, ia - IS-IS inter area
```

```
* - candidate default
```

```
C    1.1.1.1/32 is directly connected, Loopback1  tag:0
O    5.5.5.5/32 [110/3] via 100.1.1.2, Vlan100, 00:00:05  tag:0
      [110/3] via 100.1.2.2, Vlan200, 00:00:05  tag:0
C    100.1.1.0/24 is directly connected, Vlan100  tag:0
C    100.1.2.0/24 is directly connected, Vlan200  tag:0
O    100.2.1.0/24 [110/2] via 100.1.1.2, Vlan100, 00:02:25  tag:0
O    100.2.2.0/24 [110/2] via 100.1.2.2, Vlan200, 00:02:25  tag:0
C    127.0.0.0/8 is directly connected, Loopback  tag:0
      Total routes are : 8 item(s)
```

5.8.4 ECMP Troubleshooting

When configuring ECMP, ECMP may not run normally for the reasons of physical connection and false configuration, so users should note the following essential.

- ☞ When using ECMP, load-balance mode should be set as `dst-src-ip` or `dst-src-mac-ip`, after that, load-balance is correct for packets.

5.9 BFD

5.9.1 Introduction to BFD

BFD (Bidirectional Forwarding Detection) provides a detection mechanism to quickly detect and monitor the connectivity of links in networks. To improve network performance, between protocol neighbors must quickly detect communication failures to restore communication through backup paths as soon as possible.

BFD provides a general-purpose, standard, medium-independent and protocol-independent fast failure detection mechanism. It can uniformly and quickly detect the failures of the bidirectional forwarding paths between two network devices for superstratum protocols, such as routing protocols and Multiprotocol Label Switching (MPLS). BFD establishes session between two network devices to monitor their bidirectional forwarding paths to serve for superstratum

protocols. However, there is no discovery mechanism for BFD, it is notified by superstratum protocol to establish sessions. After a session is established, if no BFD control packet is received from the peer within detection time, it notifies the failure to superstratum protocol which will take appropriate measures.

5.9.2 BFD Configuration Task List

1. Configure BFD basic function
2. Configure BFD for RIP (ng)
3. Configure BFD for static route (IPv6)
4. Configure BFD for VRRP (v3)

1. Configure BFD basic function

Command	Explanation
Global Mode	
bfd mode{active passive} no bfd mode	Configure the mode before establishing BFD session, the default is active mode. No command restores active mode.
bfd authentication key <1-255> text <WORD> no bfd authentication key <1-255>	Configure key and authentication character string encrypted with text for BFD, no command deletes the configured key.
bfd authentication key <1-255> md5 <WORD> no bfd authentication key	Configure key and authentication character string encrypted with md5 for BFD, no command deletes the configured key.
Interface Mode	
bfd interval <value1> min_rx <value2> multiplier <value3> no bfd interval	Configure the minimum transmission interval and the multiplier of session detection for BFD control packets, no command restores the default detection multiplier.
bfd min-echo-receive-interval <value> no bfd min-echo-receive-interval	Configure the minimum receiving interval for BFD control packets, no command restores its default value.
bfd echo no bfd echo	Enable bfd echo, no command disables the function.
bfd echo-source-ip <ipv4-address> no bfd echo-source-ip	Detect link fault by configuring source address of echo packets,

	no command deletes the configured source address of echo packets.
bfd echo-source-ipv6 <ipv6-address> no bfd echo-source-ipv6	Detect link fault by configuring source address of echo packets, no command deletes the configured source address of echo packets.
bfd authentication key <1-255> no bfd authentication key	Enable BFD authentication and configure key for interface, no command disables BFD authentication.

2. Configure BFD for RIP (ng)

Command	Explanation
Interface Mode	
rip bfd enable no rip bfd enable	Configure BFD for RIP protocol on the specific interface, no command disables BFD for RIP protocol.
ipv6 rip bfd enable no ipv6 rip bfd enable	Configure BFD for RIPng protocol on the specific interface, no command cancels the configuration.

3. Configure BFD for static route (IPv6)

Command	Explanation
Global Mode	
ip route {vrf <name> <ipv4-address> <ipv4-address>} mask <nexthop> bfd no ip route {vrf <name> <ipv4-address> <ipv4-address>} mask <nexthop> bfd	Configure BFD for the static route, no command cancels the configuration.
ipv6 route {vrf <name> <ipv6-address> <ipv6-address>} prefix <nexthop> bfd no ipv6 route {vrf <name> <ipv6-address> <ipv6-address>} prefix <nexthop> bfd	Configure BFD for the static IPv6 route, no command cancels the configuration.

4. Configure BFD for VRRP (v3)

Command	Explanation
VRRP(v3) Group Configuration Mode	
bfd enable no bfd enable	Enable BFD for VRRP(v3) protocol and enable BFD detection on this group, no command disables the function.

5.9.3 Examples of BFD

5.9.3.1 Example for Linkage of BFD and Static Route

Example:

Configure a static route to 14.1.1.0/24 on Switch A and configure a static route to 15.1.1.0/24 on Switch B. Both switches enable BFD detection. When the link between Switch A and Switch B is failing, BFD can detect it immediately.



Figure 4- 17

Configuration procedure:

Switch A:

```
Switch#config
```

```
Switch(config)#interface vlan 12
```

```
Switch(config-if-vlan12)#ip address 12.1.1.1 255.255.255.0
```

```
Switch(config)#interface vlan 15
```

```
Switch(config-if-vlan15)#ip address 15.1.1.1 255.255.255.0
```

```
Switch(config)#ip route 14.1.1.0 255.255.255.0 12.1.1.2 bfd
```

Switch B:

```
Switch#config
```

```
Switch(config)#interface vlan 12
```

```
Switch(config-if-vlan12)#ip address 12.1.1.2 255.255.255.0
```

```
Switch(config)#interface vlan 14
```

```
Switch(config-if-vlan15)#ip address 14.1.1.1 255.255.255.0
```

```
Switch(config)#ip route 15.1.1.0 255.255.255.0 12.1.1.1 bfd
```

When the link between Switch B and layer 2 switch is failing, Switch A can detect the change of Switch B immediately, here the static routing is at inactive state.

5.9.3.2 Example for Linkage of BFD and RIP Route

Example:

Switch A and Switch B are connected and run RIP protocol, both of them enable BFD function. When the link between Switch A and Switch B is failing, BFD can detect it immediately.

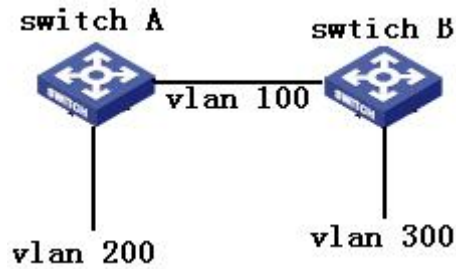

Figure 4- 18

Configuration procedure:

Switch A:

```
Switch#config
Switch(config)#bfd mode active
Switch(config)#interface vlan 100
Switch(config-if-vlan100)#ip address 10.1.1.1 255.255.255.0
Switch(config)#interface vlan 200
Switch(config-if-vlan200)#ip address 20.1.1.1 255.255.255.0
Switch(config)#router rip
Switch (config-router)#network vlan 100
Switch (config-router)#network vlan 200
Switch(config)#interface vlan 100
Switch(config-if-vlan100) #rip bfd enable
```

Switch B:

```
Switch#config
Switch(config)#bfd mode passive
Switch(config)#interface vlan 100
Switch(config-if-vlan100)#ip address 10.1.1.2 255.255.255.0
Switch(config)#interface vlan 300
Switch(config-if-vlan300)#ip address 30.1.1.1 255.255.255.0
Switch(config)#router rip
Switch (config-router)#network vlan 100
Switch (config-router)#network vlan 300
Switch(config)#interface vlan 100
Switch(config-if-vlan100) #rip bfd enable
```

When the link between Switch A and Switch B is failing, BFD can detect it immediately and notifies RIP to delete the learnt route.

5.9.3.3 Example for Linkage of BFD and VRRP

Example:

When the master is failing, the backup cannot become the master until the configured timeout timer expires. The timeout is generally three to four seconds and therefore the switchover is slow. To solve this problem, VRRP uses BFD to probe the state of the master. Once the master fails, the backup can become the new master within 100 ms.

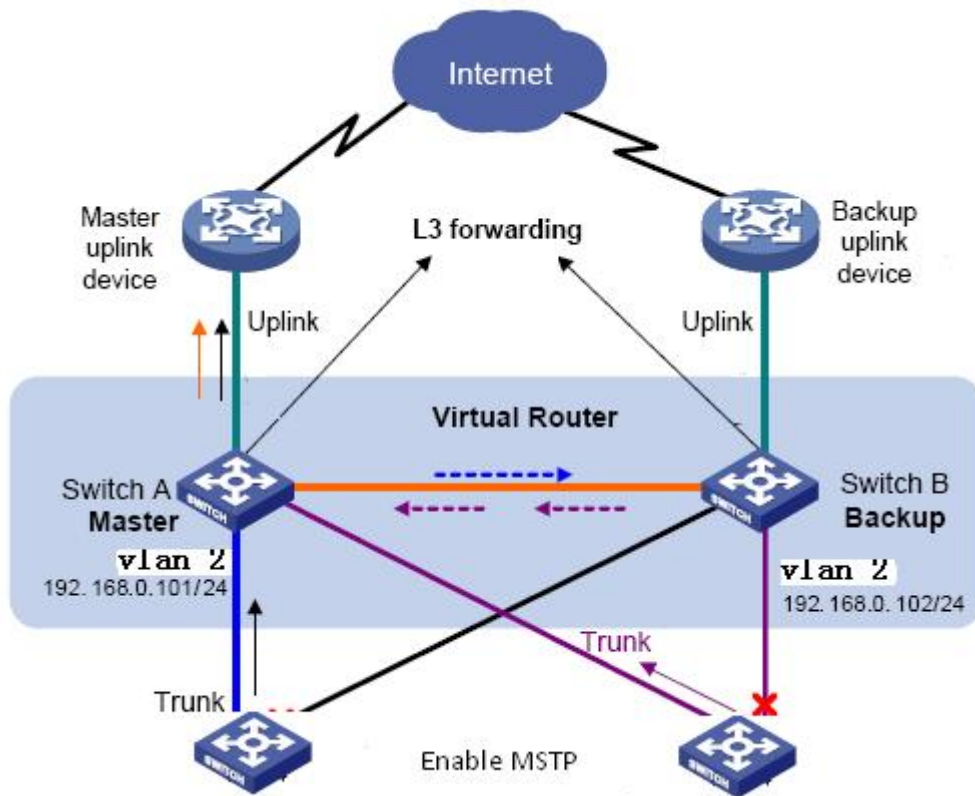

Figure 4- 19

Configuration procedure:

Configure Switch A

```
Switch#config
```

```
Switch(config)#bfd mode active
```

```
Switch(config)#interface vlan 2
```

```
Switch(config-ip-vlan2)#ip address 192.16.0.101 255.255.255.0
```

```
Switch(config)#router vrrp 1
```

```
Switch(config-router)#virtual-ip 192.168.0.10
```

```
Switch(config-router)#interface vlan 1
```

```
Switch(config-router)#enable
```

```
Switch(config-router)#bfd enable
```

Configure Switch B

```
Switch#config
```

```
Switch(config)#bfd mode passive
```

```
Switch(config)#interface vlan 2
```

```
Switch(config-ip-vlan2)#ip address 192.16.0.102 255.255.255.0
```

```
Switch(config)#router vrrp 1
```

```
Switch(config-router)#virtual-ip 192.168.0.10
```

```
Switch(config-router)#interface vlan 1
```

```
Switch(config-router)#enable
```

```
Switch(config-router)#bfd enable
```

5.9.4 BFD Troubleshooting

When the problem of BFD function happens, please check whether the problem is resulted by the following reasons:

- 👉 Check whether the route protocol neighbor is established successfully. If no route protocol neighbor is established successfully, here BFD can not process the detection.
- 👉 Check whether the configured source-ip is correct for linkage with static route, if the connectivity of IP between two peers fails, BFD can not process the detection.
- 👉 Check whether VRRP group is established successfully for linkage with VRRP protocol. If no VRRP group is established successfully, here BFD can not process the detection.

5.10 BGP GR

5.10.1 Introduction to GR

Along with network development, it requires the higher availability, so HA (High Availability) is set, namely, how to ensure packets to be forwarded and does not affect traffic operation when router control layer can not work normally.

Usually, when a router does not work normally, neighbor in route protocol layer will detect their relationship to be down, and is up soon. The process is called neighborhood shock. This shock will result the router shock that will eventually result router black hole or data passed by restarted router. Finally network availability will decrease quickly.

In order to achieve high availability, it needs upper layer route protocol to support GR (Graceful Restart). Use GR can ensure that packets can be processed or forwarded correctly when the control layer is failing.

GR can reduce route shock, resource expend consumption of control layer and improve network stability. What describe in this document is GR, which can restart BGP protocol without affecting forwarding process, and forward packets in the correct path.

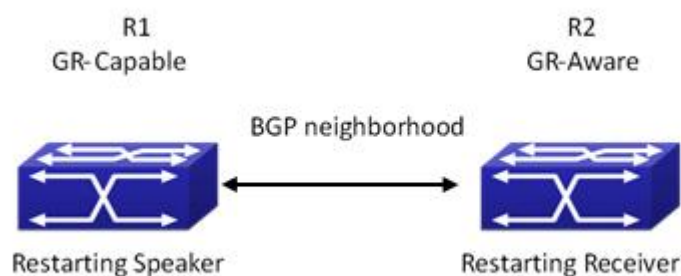

Figure 4-20 Application environment for GR

GR needs cooperation of GR-Capable router and GR-Aware router to complete. A restarted router is called Restarting Speaker (or GR-Restarter), and its neighbor can be called Receiving Speaker (or GR-Helper). Restarting Speaker is GR-Capable router while Receiving Speaker is GR-Aware router. In this way, they can complete GR. Suppose that router R1 and R2 establish BGP neighborhood, as shown in Fig 13- 1, GR process can be described as:

Restarting Speaker (GR-Restarter) :

1. R1 and R2 negotiate GR capability through OPEN when establish original BGP neighbor.
2. When R1 is restarted, the route is kept in the interface board and guide forwarding continuously.
3. R1 establishes TCP connection with R2 again, it sets Restart state to 1 in BGP OPEN messages to show that this router has been restarted. At the same time, it will inform the value of restart time (it is less than Holdtime in OPEN messages) to neighbor. Additionally, it should inform neighbor what type of GR is supported.
4. After R1 is established connection with R2 correctly, it is able to receive and deal with the update information and enable selection deferral timer.
5. R1 delays the count process of the local BGP route until it receives all End-of-RIB from BGP neighbors in GR-Aware or until the local selection deferral timer is overtime.
6. Count route and send the update route. After that, it will send End-of-RIB to neighbors.

Restarting Speaker (GR-Helper) :

1. R1 and R2 negotiate GR capability with the restarted router when they establish the original neighborhood with BGP, R1 is a router that support GR-Capable.
2. When R1 is restarted, R2 may senses that TCP between R1 and R2 is cut off or cannot detect the previous state before they establish TCP connection again. If it does not detect it, go to step 4, otherwise go to step 3.
3. Keep the route sent by R1 and mark a stale label. After that, enable Restart Timer.
4. Cut off old TCP connection and deal with new TCP connection continuously. Keep the route sent by R1 and mark a stale label. After that, enable Restart Timer.
5. Establish a new neighborhood with the restarted router, delete Restart Timer and enable Stale Path Timer.
6. Before establish the new neighborhood, If Restart Timer is overtime, Restart flag does not equal 1, or there is no relevant supporting information in AFI/SAFI address family, please clear the kept route.
7. Send the route update information to the restarted router, after that, it will send End-Of-RIB label.
8. If Stale Path Timer is overtime, clear the kept route.

5.10.2 GR Configuration Task List

1. Configure whether GR capability is supported
2. Configure whether the specific neighbor supports GR capability
3. Configure restart-time
4. Configure restart-time for neighbor
5. Configure stale-path-time for BGP GR

6. Configure selection-deferral-time for BGP GR

1. Configure whether GR capability is supported

Command	Description
BGP route configuration mode	
bgp graceful-restart no bgp graceful-restart	Enable BGP to support GR.

2. Configure whether the specific neighbor supports GR capability

Command	Description
BGP protocol unicast address family mode and VRF address family mode	
neighbor (A.B.C.D X:X::X:X WORD) capability graceful-restart no neighbor (A.B.C.D X:X::X:X WORD) capability graceful-restart	Set a label for neighbor, it takes GR parameter when send OPEN messages.

3. Configure restart-time

Command	Description
BGP route configuration mode	
bgp graceful-restart restart-time <1-3600> no bgp graceful-restart restart-time <1-3600>	Configure BGP GR's restart-time (Receiving Speaker enables a timeout timer for a neighbor, it uses the restart-time as the timeout). A restart-time specifies the longest waiting time from Receiving Speaker finds restarting to the received OPEN messages. If Receiving Speaker does not receive OPEN messages after exceed the time, it can delete SATLE route saved by neighbor.

4. Configure restart-time for neighbor

Command	Description
BGP protocol unicast address family mode and VRF address family mode	
neighbor (A.B.C.D X:X::X:X WORD) restart-time <1-3600> no neighbor (A.B.C.D X:X::X:X WORD) restart-time <1-3600>	Configure restart-time for neighbors, no command restores the default time.

5. Configure stale-path-time for BGP GR

Command	Description
BGP route configuration mode	
bgp graceful-restart stale-path-time	Stalepath-time uses the default value of

<pre><1-3600> no bgp graceful-restart stale-path-time <1-3600></pre>	<p>360s, which is much longer than restart-time and selection-deferral-time. Because during the time from Receiving Speaker receives OPEN messages to receives EOR, it sends the initial route update and waits that the initial route update is received completely.</p>
--	---

6. Configure selection-deferral-time for BGP GR

Command	Description
BGP route configuration mode	
<pre>bgp selection-deferral-time <1-3600> no bgp selection-deferral-time <1-3600></pre>	<p>Specify the longest waiting time that start to count selection route from the received OPEN messages to the received EOR for Restarting Speaker. If Restarting Speaker does not receive EOR after exceed the time, it can count selection route.</p>

5.10.3 Typical Example of GR



Figure 4- 21 Application environment for GR

As shown in Figure 4- 21, R1 and R2 establish BGP neighborhood. When they cut off the connection, BGP protocol in R2 will be in helper mode, keep route entry from R1 to R2 and restart restart-time timer. During that time, if it receives open messages from R1 or timer is overtime, the route marked with stale in R2 will be deleted. When they establish neighborhood again, R1 will enable selection timer and wait R2 to send EOR messages or until timer is overtime, R1 is a selection route. However, after R2 receives open messages from R1, it enables STALE route timer and it will delete timer and stale route when accept EOR from R1 or timer is overtime.

R1 configures int vlan 12, ip address 12.1.1.1

R2 configures int vlan 12, ip address 12.1.1.2

R1 configuration:

```
R1#config
```

```
R1(config)#vlan 12
```

```
R1(config-vlan12)#int vlan 12
```

```
R1(config-if-vlan12)#ip address 12.1.1.1 255.255.255.0
```

```
R1(config-if-vlan12)#exit
```

```
R1(config)#router bgp 1
R1(config-router)#neighbor 12.1.1.2 remote-as 2
R1(config-router)#neighbor 12.1.1.2 capability graceful-restart
R1(config-router)#bgp selection-deferral-time 120
R1(config-router)#bgp graceful-restart restart-time 60
R1(config-router)#bgp graceful-restart stale-path-time 180
R1(config-router)#exit
```

R2 configuration:

```
R2#config
R2(config)#vlan 12
R2(config-vlan12)#int vlan 12
R2(config-if-vlan12)#ip address 12.1.1.2 255.255.255.0
R2(config-if-vlan12)#exit
R2(config)#router bgp 2
R2(config-router)#neighbor 12.1.1.1 remote-as 1
R2(config-router)#neighbor 12.1.1.1 capability graceful-restart
R2(config-router)#bgp selection-deferral-time 120
R2(config-router)#bgp graceful-restart restart-time 60
R2(config-router)#bgp graceful-restart stale-path-time 180
R2(config-router)#exit
```

5.11 OSPF GR

5.11.1 Introduction to OSPF GR

OSPF Graceful-Restart (short for OSPF GR), is used to maintain data forwarding correctly and flow of crucial service is not interrupted when routing protocol restarts or switchover of layer 3 switches between active master and standby master. It is one of high availability technologies.

So far, the high layer 3 switches usually adopt a design for separating control and forwarding. The control module for counting routing protocol at master control board, but data forwarding module is at liner card. As a result, it will not affect data forwarding on line card when the master control board is restarted. So the device supporting GR is generally a chassis device and has two master control boards.

Since standard OSPF protocol (RFC2328) does not support GR, it will lead to flow cut off and routing surge when routing protocol is restarted or switchover between active master and standby master for various reasons. For example, as shown in below figure, when S1 occurs switchover, the neighborhood relation between S1 and S2 will lose, at that time S2 will send Router-LSA to S3 and S4 and this LSA does not include the link between S1 and S2. After S3 and S4 received LSA, they will count routing protocol again. The result will not include the link between S1 and S2. After S1 finishes the switchover, it will establish neighborhood relation with S2 and synchronize database, this action leads S2, S3 and S4 to count routing again. However,

switchover of S1 will result routing shiver, which is not accepted by some networks with high requirement for performance.

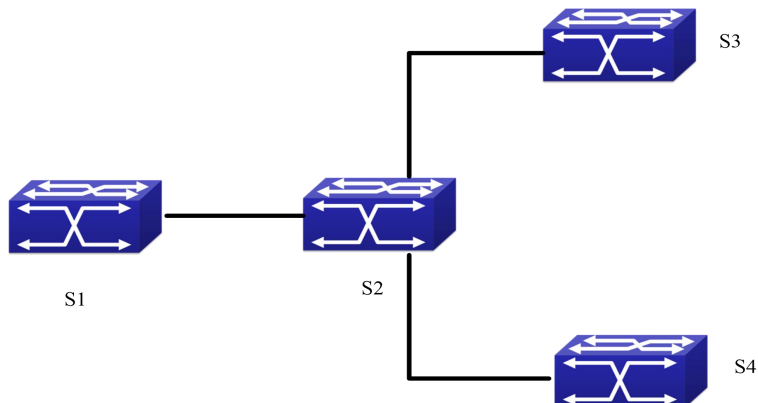

Figure 4-22 typical application scene

OSPF GR described in RFC 3623 is come up for the above state. Its basic idea is that if the network topology keeps stabilization during the switchover and layer 3 switch can maintain the same forwarding list, then its neighbor can maintain their relationship, which can make the switch on its forwarding path still. If S1 and S2 support and enable GR, the liner card of S1 will keep the traffic forwarding and S2 can maintain the relationship with S1, at the same time, network topology between S3 and S4 will not be changed, furthermore, it does not need to count routing again. All of these ensure the traffic forwarding and avoid routing shiver.

Layer 3 switch can be divided into GR restarter and GR helper according to its function in GR process. GR restarter is layer 3 switch to occur the switchover between active master and standby master or restart protocol while GR helper is layer 3 switch to help GR restarter. In the above example, S1 is GR restarter and S2 is GR helper

The advantages of OSPF GR in the following:

- ☞ Increase network reliability
- ☞ Reduce the effect of routing shiver to network
- ☞ Reduce the effect to traffic and avoid that lose packets during switchover

5.11.2 OSPF GR Configuration

OSPF GR configuration task list:

1. Enable GR for OSPF
2. Configure grace-period for OSPF GR restarter (optional)
3. Configure policy for OSPF GR helper (optional)

1. Enable GR for OSPF

Command	Description
OSPF protocol configuration mode	
capability restart graceful no capability restart	Enable GR of specific OSPF.

2. Configure grace-period for OSPF GR restarter (optional)

Command	Description
Global configuration mode	
ospf graceful-restart grace-period <integer> no ospf restart grace-period	Configure grace period for GR restarter (The switch is used to the switchover or restart the protocol). The no command restores its default value.

3. Configure the policy for OSPF GR helper (optional)

Command	Description
Global configuration mode	
ospf graceful-restart helper max-grace-period <integer> no ospf graceful-restart helper	One of GR helper policy. Configure maximum grace period supported by helper. The no command deletes all configured helper policy.
ospf graceful-restart helper never no ospf graceful-restart helper	One of GR helper policy. Configure the switch can not become OSPF GR helper. The no command deletes all configured helper policy.

5.11.3 OSPF GR Example

Example:

There are four switches from S1 to S4 (They are two master control board and supports OSPF GR), they enable OSPF to implement the following functions:

1. S1 keeps traffic forwarding during the switchover, S2-S4 ensure that no routing shiver and the continuous network traffic.
2. S1 needs to finish the switchover and restart protocol within 120s, otherwise S2 will quit GR and count routing again.
3. S1 does not work as a OSPF GR Helper (S1 will not help S2 to process GR, but it will count routing again when S2 processes the switchover or restart OSPF protocol).

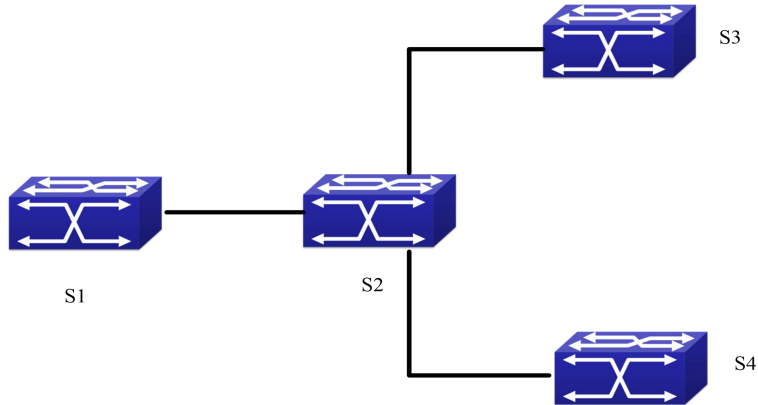

Figure 4-23 Typical application

Steps: Since the switch enables OSPF GR by default, we only need to configure the parameters and helper policy for OSPF GR. (the following configuration is relative with OSPF GR only and that of topology is omitted).

S1

```
S1(config)#ospf graceful-restart grace-period 120
```

```
S1(config)# ospf graceful-restart helper never
```

S2

```
S2(config)# ospf graceful-restart helper max-grace-period 120
```

5.11.4 OSPF GR Troubleshooting

When you have trouble in using OSPF GR, please check the following reasons:

- ☞ Whether GR restarter switch supports OSPF GR and has two main control boards, please ensure that specific GR is not disabled.
- ☞ Whether network topology is changed during OSPF GR process. When it is changed, switch may quit GR and restart OSPF.
- ☞ Please ensure all neighbors of GR restarter support GR.
- ☞ Do not modify the relevant configuration of OSPF during GR.

Chapter 6 IPv4 Multicast Protocol Related Configuration

6.1 IPv4 Multicast Protocol Overview

This chapter will give an introduction to the configuration of IPv4 Multicast Protocol.

6.1.1 Introduction to Multicast

Various transmission modes can be adopted when the destination of packet (including data, sound and video) transmission is the minority users in the network. One way is to use Unicast mode, i.e. to set up a separate data transmission path for each user; or, to use Broadcast mode, which is to send messages to all users in the network, and they will receive the Broadcast messages no matter they need or not. For example, if there are 200 users in a network who want to receive the same packet, then the traditional solution is to send this packet for 200 times separately via Unicast to guarantee the users who need the data can get all data wanted, or send the data in the entire domain via Broadcast. Transferring the data in the whole range of network. The users who need these data can get directly from the network. Both modes waste a great deal of valuable bandwidth resource, and furthermore, Broadcast mode goes against the security and secrecy.

The emergence of IP Multicast technology solved this problem in time. The Multicast source only sends out the message once, Multicast Routing Protocol sets up tree-routing for Multicast data packet, and then the transferred packet just starts to be duplicated and distributed in the bifurcate crossing as far as possible. Thus the packet can be sent to every user who needs it accurately and effectively.

It should be noticed that it is not necessary for Multicast source to join in Multicast group. It sends data to some Multicast groups, but it is not necessarily a receiver of the group itself. There can be more than one source sending packets to a Multicast group simultaneously. There may exist routers in the network which do not support Multicast, but a Multicast router can encapsulate the Multicast packets into Unicast IP packets with tunnel mode to send them to the Multicast router next to it, which will take off the Unicast IP header and continue the Multicast transmission process, thus a big alteration of network structure is avoided. The primary advantages of Multicast are:

1. Enhance efficiency: reduce network traffic, lighten the load of server and CPU
1. Optimize performance: reduce redundant traffic
1. Distributed application: Enable Multipoint Application

6.1.2 Multicast Address

The destination address of Multicast message uses class D IP address with range from

224.0.0.0 to 239.255.255.255. D class address can not appear in the source IP address field of an IP message. In the process of Unicast data transmission, the transmission path of a data packet is from source address routing to destination address, and the transmission is performed with hop-by-hop principle. However, in IP Multicast environment, the destination addresses is a group instead of a single one, they form a group address. All message receivers will join in a group, and once they do, the data flowing to the group address will be sent to the receivers immediately and all members in the group will receive the data packets. The members in a Multicast group are dynamic, the hosts can join and leave the Multicast group at any time.

Multicast group can be permanent or temporary. Some of the Multicast group addresses are assigned officially; they are called Permanent Multicast Group. Permanent Multicast Group keeps its IP address fixed but its member structure can vary within. The member amount of Permanent Multicast Group can be arbitrary, even zero. The IP Multicast addresses which are not kept for use by Permanent Multicast Group can be utilized by temporary Multicast groups.

224.0.0.0 ~ 224.0.0.255 are reserved Multicast addresses (Permanent Group Address), address 224.0.0.0 is reserved but not assigned, and other addresses are used by Routing Protocol; 224.0.1.0~238.255.255.255 are Multicast addresses available to users(Temporary Group Address) and are valid in the entire domain of the network; 239.0.0.0 ~ 239.255.255.255 are local management Multicast addresses, which are valid only in specific local domain. Frequently used reserved multicast address list is as follows:

- Benchmark address (reserved)
- 224.0.0.1 Address of all hosts
- 224.0.0.2 Address of all Multicast Routers
- 224.0.0.3 Unassigned
- 224.0.0.4 DVMRP Router
- 224.0.0.5 OSPF Router
- 224.0.0.6 OSPF DR
- 224.0.0.7 ST Router
- 224.0.0.8 ST host
- 224.0.0.9 RIP-2 Router
- 224.0.0.10 IGRP Router
- 224.0.0.11 Active Agent
- 224.0.0.12 DHCP Server/Relay Agent
- 224.0.0.13 All PIM Routers
- 224.0.0.14 RSVP Encapsulation
- 224.0.0.15 All CBT Routers
- 224.0.0.16 Specified SBM
- 224.0.0.17 All SBMS
- 224.0.0.18 VRRP
- 224.0.0.22 IGMP

When Ethernet transmits Unicast IP messages, the destination MAC address it uses is the receiver's MAC address. But in transmitting Multicast packets, the transmission destination is not a specific receiver any more, but a group with uncertain members, thus Multicast MAC address is used. Multicast MAC address is corresponding to Multicast IP address. It is prescribed in IANA (Internet Assigned Number Authority) that the higher 25 bits in Multicast MAC address is

0x01005e, and the lower 23bits in MAC address is the lower 23bits in Multicast IP address.

Since only 23bits out of the lower 28bits in IP Multicast address are mapped into MAC address, therefore there are 32 IP Multicast addresses which are mapped into the same MAC address.

6.1.3 IP Multicast Packet Transmission

In Multicast mode, the source host sends packets to the host group indicated by the Multicast group address in the destination address field of IP data packet. Unlike Unicast mode, Multicast data packet must be forwarded to a number of external interfaces to be sent to all receiver sites in Multicast mode, thus Multicast transmission procedure is more complicated than Unicast transmission procedure.

In order to guarantee that all Multicast packets get to the router via the shortest path, the receipt interface of the Multicast packet must be checked in some certain way based on Unicast router table; this checking mechanism is the basis for most Multicast Routing Protocol to forward in Multicast mode --- RPF (Reverse Path Forwarding) check. Multicast router makes use of the impressed packet source address to query Unicast Router Table or independent Multicast Router Table to determine if the packet ingress interface is on the shortest path from receipt site to source address. If shortest path Tree is used, then the source address is the address of source host which sends Multicast Data Packets; if Shared Tree is used, then the source address is the address of the root of the Shared-Tree. When Multicast data packet gets to the router, if RPF check passes, then the data packet is forwarded according to Multicast forward item, and the data packet will be discarded else wise.

6.1.4 IP Multicast Application

IP Multicast technology has effectively solved the problem of sending in single point and receiving in multipoint. It has achieved the effective data transmission from a point to multiple points, saved a great deal of network bandwidth and reduced network load. Making use of the Multicast property of network, some new value-added operations can be supplied conveniently. In Information Service areas such as online living broadcast, network TV, remote education, remote medicine, real time video/audio meeting, the following applications may be supplied:

- 1) Application of Multimedia and Streaming Media
- 2) Data repository, finance application (stock) etc
- 3) Any data distribution application of “one point to multiple points”

In the situation of more and more multimedia operations in IP network, Multicast has tremendous market potential and Multicast operation will be generalized and popularized.

6.2 PIM-DM

6.2.1 Introduction to PIM-DM

PIM-DM (Protocol Independent Multicast, Dense Mode) is a Multicast Routing Protocol in dense mode which applies to small network. The members of multicast group are relatively dense under this kind of network environment.

The working process of PIM-DM can be summarized as: Neighbor Discovery, Flooding & Prune, and Graft.

1. Neighbor Discovery

After PIM-DM router is enabled, Hello message is required to discover neighbors. The network nodes which run PIM-DM use Hello message to contact each other. PIM-DM Hello message is sent periodically.

2. Flooding & Prune of process

PIM-DM assumes all hosts on the network are ready to receive Multicast data. When some Multicast Source begins to send data to a Multicast Group G, after receiving the Multicast packet, the router will make RPF check first according to the Unicast table. If the check passes, the router will create a (S, G) table entry and transmit the Multicast packet to all downstream PIM-DM nodes on the network (Flooding). If the RPF check fails, i.e. the Multicast packet is input from the incorrect interface, and then the message is discarded. After this procedure, in the PIM-DM Multicast domain, every node will create a (S, G) table entry. If there is no Multicast group member in the downstream nodes, then a Prune message is sent to upstream nodes to notify them not to transmit data of this Multicast group any more. After receiving Prune message, the upstream nodes will delete the corresponding interface from the output interface list to which their Multicast transmission table entry (S, G) corresponds. Thus a SPT (Shortest Path Tree, SPT) tree with source S as root is created. The Prune process is initiated by leaf router first.

The process above is called Flooding & Prune process. Each pruned node also provides time-out mechanics at the same time. When Prune is timed-out, the router will restart Flooding & Prune process. The PIM-DM Flooding & Prune is periodically processed.

3. RPF Check

With RPF Check, PIM-DM makes use of existing Unicast routing table to establish a Multicast transmission tree initiating from data source. When a Multicast packet arrives, the router will determine whether the coming path is correct first. If the arrival interface is the interface connected to Multicast source indicated by Unicast routing, then this Multicast packet is considered to be from the correct path. Otherwise the Multicast packet is to be discarded as redundant message. The Unicast routing message used as path judgment can root in any Unicast Routing Protocol, such as messages found by RIP, OSPF, etc. It doesn't rely on any specific Unicast Routing Protocol.

4. Assert Mechanism

If each of two Multicast routers A and B on the same LAN segment has a receiving route respectively and both will transmit the Multicast packet to the LAN after receiving the Multicast data packet sent by the Multicast Source S, then the downstream node Multicast router C will receive two exactly same Multicast packets. The router needs to choose a unique transmitter through Assert mechanism after it detects this situation. An optimal transmission path is selected through sending out Assert packet. If the priority and cost of two or more path are same, then the node with larger IP address is taken as the upstream neighbor of the (S, G) entry and in charge of the transmission of the (S, G) Multicast packet.

5. Graft

When the pruned downstream node needs to recover to transmission status, this node uses Graft Packet to notify upstream nodes to restore multicast data transmission.

6.2.2 PIM-DM Configuration Task List

1. Enable PIM-DM (Required)
2. Configure static multicast routing entries(Optional)
3. Configure additional PIM-DM parameters(Optional)
 - a) Configure the interval for PIM-DM hello messages
 - b) Configure the interval for state-refresh messages
 - c) Configure the boundary interfaces
 - d) Configure the management boundary
4. Disable PIM-DM protocol

1. Enable the PIM-DM protocol

When configuring the PIM-DM protocol on Layer 3 switches, PIM multicasting should be enabled globally, then PIM-DM can be enabled for specific interfaces.

Command	Explanation
Global Mode	
ip pim multicast-routing no ip pim multicast-routing	To enable PIM-DM globally for all the interfaces (However, in order to make PIM-DM work for specific interfaces, the following command should be issued).

And then turn on PIM-SM switch on the interface

Command	Explanation
Interface Configuration Mode	
ip pim dense-mode	To enable PIM-DM protocol for the specified interface.(Required)

2. Configure static multicast routing entries

Command	Explanation
Global Configuration Mode	
ip mroute <A.B.C.D> <A.B.C.D> <ifname> <ifname> no ip mroute <A.B.C.D> <A.B.C.D> [<ifname> <ifname>]	To configure a static multicast routing entry. The no form of this command will remove the specified entry.

3. Configure additional PIM-DM parameters

- a) Configure the interval for PIM-DM hello messages

Command	Explanation
Interface Configuration Mode	

ip pim hello-interval < <i>interval</i> > no ip pim hello-interval	To configure the interval for PIM-DM hello messages. The no form of this command will restore the interval to the default value.
---	--

b) Configure the interval for state-refresh messages

Command	Explanation
Interface Configuration Mode	
ip pim state-refresh origination-interval no ip pim state-refresh origination-interval	To configure the interval for sending PIM-DM state-refresh packets. The no form of this command will restore the default value.

c) Configure the boundary interfaces

Command	Explanation
Interface Configuration Mode	
ip pim bsr-border no ip pim bsr-border	To configure the interface as the boundary of PIM-DM protocol. On the boundary interface, BSR messages will not be sent or received. The network connected the interface is considered as directly connected network. The no form of this command will remove the configuration.

d) Configure the management boundary

Command	Explanation
Interface Configuration Mode	
ip pim scope-border <1-99> <acl_name> no ip pim scope-border	To configure PIM-DM management boundary for the interface and apply ACL for the management boundary. With default settings, 239.0.0.0/8 is considered as the scope of the management group. If ACL is configured, then the scope specified by ACL permit command is the scope of the management group. The no form of this command will remove the configuration.

4. Disable PIM-DM protocol

Command	Explanation
Interface Configuration Mode	
no ip pim dense-mode	To disable the PIM-DM protocol for the interface.
Global Configuration Mode	
no ip pim multicast-routing	To disable PIM-DM globally.

6.2.3 PIM-DM Configuration Examples

As shown in the following figure, add the Ethernet interfaces of Switch A and Switch B to corresponding vlan, and enable PIM-DM Protocol on each vlan interface.

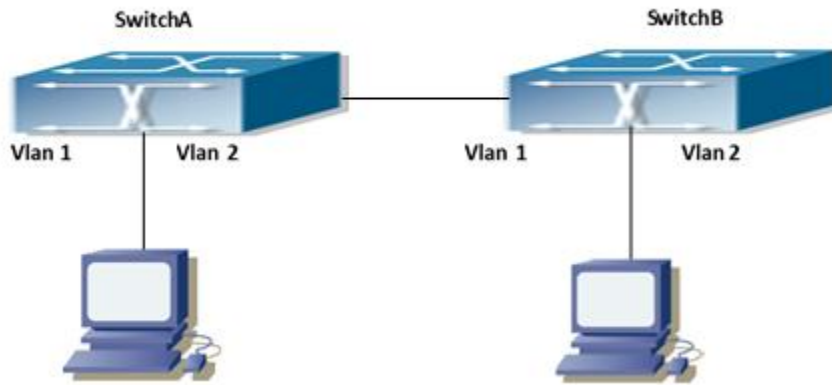

Figure 5- 1 PIM-DM Typical Environment

The configuration procedure for SwitchA and SwitchB is as follows:

(1) Configure SwitchA:

```
Switch(config)#ip pim multicast-routing
Switch(config)#interface vlan 1
Switch(Config-if-Vlan1)# ip address 10.1.1.1 255.255.255.0
Switch(Config-if-Vlan1)# ip pim dense-mode
Switch(Config-if-Vlan1)#exit
Switch(config)#interface vlan 2
Switch(Config-if-Vlan2)# ip address 12.1.1.1 255.255.255.0
Switch(Config-if-Vlan2)# ip pim dense-mode
```

(2) Configure SwitchB:

```
Switch(config)#ip pim multicast-routing
Switch(config)#interface vlan 1
Switch(Config-if-Vlan1)# ip address 12.1.1.2 255.255.255.0
Switch(Config-if-Vlan1)# ip pim dense-mode
Switch(Config-if-Vlan1)#exit
Switch(config)#interface vlan 2
Switch(Config-if-Vlan2)# ip address 20.1.1.1 255.255.255.0
Switch(Config-if-Vlan2)# ip pim dense-mode
```

At the same time, you should pay attention to the configuration of Unicast Routing Protocol, assure that each device can communicate with each other in the network layer, and be able to implement dynamic routing update in virtue of Unicast Routing Protocol.

6.2.4 PIM-DM Troubleshooting

In configuring and using PIM-DM Protocol, PIM-DM Protocol might not operate normally caused by physical connection or incorrect configuration. Therefore, the user should pay attention to the following issues:

- ☞ To assure that physical connection is correct
- ☞ To assure the Protocol of Interface and Link is UP (use show interface command)
- ☞ To assure PIM Protocol is enabled in Global Mode (use ipv6 pim multicast-routing)
- ☞ Enable PIM-DM Protocol on the interface (use ipv6 pim dense-mode command)

☞ Multicast Protocol requires RPF Check using Unicast routing; therefore the correctness of Unicast routing must be assured beforehand

If all attempts including Check are made but the problems on PIM-DM can't be solved yet, then use debug commands such as debug pim please, and then copy DEBUG information in 3 minutes and send to Technology Service Center.

6.3 PIM-SM

6.3.1 Introduction to PIM-SM

PIM-SM (Protocol Independent Multicast, Sparse Mode) is Protocol Independent Multicast Sparse Mode. It is a Multicast Routing Protocol in Sparse Mode and mainly used in big scale network with group members distributed relatively sparse and wide-spread. Unlike the Flooding & Prune of Dense Mode, PIM-SM Protocol assumes no host needs receiving Multicast data packets. PIM-SM router transmits Multicast Data Packets to a host only if it presents explicit requirement.

By setting RP (Rendezvous Point) and BSR (Bootstrap Router), PIM-SM announce Multicast packet to all PIM-SM routers and establish RPT (RP-rooted shared tree) based on RP using Join/Prune message of routers. Consequently the network bandwidth occupied by data packets and message control is cut down and the transaction cost of routers decreases. Multicast data get to the network segment where the Multicast group members are located along the shared tree flow. When the data traffic reaches a certain amount, Multicast data stream can be switched to the shortest path tree SPT based on the source to reduce network delay. PIM-SM doesn't rely on any specific Unicast Routing Protocol but make RPF Check using existing Unicast routing table.

1. PIM-SM Working Principle

The central working processes of PIM-SM are: Neighbor Discovery, Generation of RP Shared Tree (RPT), Multicast source registration, SPT Switch, etc. We won't describe the mechanism of Neighbor Discovery here since it is same as that of PIM-DM.

(1) Generation of RP Shared Tree (RPT)

When a host joins a Multicast Group G, the leaf router that is connected to this host directly finds out through IGMP message that there is a receiver of Multicast Group G, then it works out the corresponding Rendezvous Point RP for Multicast Group G, and send join message to upper lever nodes in RP direction. Every router on the way from the leaf router to RP will generate a (*, G) table entry, where a message from any source to Multicast group applies to this entry. When RP receives the message sent to Multicast Group G, the message will get to the leaf router along the set up path and reach the host. In this way the RPT with RP as root is generated.

(2) Multicast Source Registration

When a Multicast Source S sends a Multicast packet to Multicast Group G, the PIM-SM Multicast router connected to it directly will take charge of encapsulating the Multicast packet into registered message and unicast it to corresponding RP. If there are more than one PIM-SM Multicast routers on a network segment, then DR (Designated Router) takes charge of sending the Multicast packet.

(3) SPT Switch

When the Multicast router finds that the rate of the Multicast packet from RP with destination address G exceeds threshold, the Multicast router will send Join message to the next upper level nodes in the source direction, which results in the switch from RPT to SPT.

2. Preparation before PIM-SM configuration

(1) Configuration Candidate RP

More than one RPs (candidate RP) can exist in PIM-SM network and each C-RP (Candidate RP) takes charge of transmitting Multicast packets with destination address in a certain range. To configure more than one candidate RPs can implement RP load share. No master or slave is differentiated among RPs. All Multicast routers work out the RP corresponding to some Multicast group based on the same algorithm after receiving the candidate RP message announced by BSR.

Note that one RP can serve more than one Multicast groups and all Multicast groups. Each Multicast group can only correspond to one unique RP at any moment. It can't correspond to more than one RP at the same time.

(2) Configure BSR

BSR is the management center of PIMSM network. It is in charge of collecting messages sent by candidate RPs and broadcast them.

Only one BSR can exist within a network, but more than one C-BSR (Candidate-BSR) can be configured. In this way, if some BSR goes wrong, it can switch to another. C-BSRs elect BSR automatically.

6.3.2 PIM-SM Configuration Task List

1. Enable PIM-SM (Required)
2. Configure static multicast routing entries (Optional)
3. Configure additional parameters for PIM-SM (Optional)
 - (1) Configure parameters for PIM-SM interfaces
 - 1) Configure the interval for PIM-SM hello messages
 - 2) Configure the hold time for PIM-SM hello messages
 - 3) Configure ACL for PIM-SM neighbors
 - 4) Configure the interface as the boundary interface of the PIM-SM protocol
 - 5) Configure the interface as the management boundary of the PIM-SM protocol
 - (2) Configure global PIM-SM parameters
 - 1)Configure the switch as a candidate BSR
 - 2)Configure the switch as a candidate RP
 - 3)Configure static RP
 - 4)Configure the cache time of kernel multicast route
4. Disable PIM-SM Protocol

1. Enable PIM-SM Protocol

The PIM-SM protocol can be enabled on Layer 3 switches by enabling PIM in global

configuration mode and then enabling PIM-SM for specific interfaces in the interface configuration mode.

Command	Explanation
Global Mode	
ip pim multicast-routing	To enable the PIM-SM protocol for all the interfaces (However, in order to make PIM-SM work for specific interfaces, the following command should be issued).(Required)

And then turn on PIM-SM switch on the interface

Command	Explanation
Interface Configuration Mode	
ip pim sparse-mode	Enable PIM-SM Protocol of the interface. (Required).

2. Configure static multicast routing entries

Command	Explanation
Global Configuration Mode	
ip mroute <A.B.C.D> <A.B.C.D> <ifname> <ifname> no ip mroute <A.B.C.D> <A.B.C.D> [<ifname> <ifname>]	To configure a static multicast routing entry. The no form of this command will remove the specified static multicast routing entry.

3. Configure additional parameters for PIM-SM

(1) Configure parameters for PIM-SM interfaces

1)Configure the interval for PIM-SM hello messages

Command	Explanation
Interface Configuration Mode	
ip pim hello-interval <interval> no ip pim hello-interval	To configure the interval for PIM-SM hello messages. The no form of this command restores the interval to the default value.

2)Configure the hold time for PIM-SM hello messages

Command	Explanation
Interface Configuration Mode	
ip pim hello-holdtime <value> no ip pim hello-holdtime	To configure the value of the holdtime field in the PIM-SM hello messages. The no form of this command will restore the hold time to the default value.

3)Configure ACL for PIM-SM neighbors

Command	Explanation
Interface Configuration Mode	
ip pim neighbor-filter{<access-list-number> }	To configure ACL to filter PIM-SM neighbors. If session to the neighbor has been denied by ACL, then the sessions that have been set up will be

no ip pim neighbor-filter {<access-list-number> } }	discarded immediately and new sessions will not be set up.
---	--

4) Configure the interface as the boundary interface of the PIM-SM protocol

Command	Explanation
Interface Configuration Mode	
ip pim bsr-border no ip pim bsr-border	To configure the interface as the boundary of PIM-SM protocol. On the boundary interface, BSR messages will not be sent or received. The network connected the interface is considered as directly connected network. The no form of this command will remove the configuration.

5) Configure the interface as the management boundary of the PIM-SM protocol

Command	Explanation
Interface Configuration Mode	
ip pim scope-border <1-99 > <acl_name> no ip pim scope-border	To configure PIM-SM management boundary for the interface and apply ACL for the management boundary. With default settings, 239.0.0.0/8 is considered as the scope of the management group. If ACL is configured, then the scope specified by ACL permit command is the scope of the management group. acl_name should be standard IPv4 ACL name. The no form of this command will remove the configuration.

(2) Configure global PIM-SM parameter

1) Configure the switch as a candidate BSR

Command	Explanation
Global Configuration Mode	
ip pim bsr-candidate { vlan <vlan-id> tunnel <tunnel-id> loopback <loopback-id> <ifname>} [<mask-length>] [<priority> >] no ip pim bsr-candidate	This command is the global candidate BSR configuration command, which is used to configure the information of PIM-SM candidate BSR so that it can compete for BSR router with other candidate BSR. The “ no ip pim bsr-candidate ” command cancels the configuration of BSR.

2) Configure the switch as a candidate RP

Command	Explanation
Global Configuration Mode	
ip pim rp-candidate { vlan <vlan-id> loopback <index> <ifname>} [<A.B.C.D>][<priority>] no ip pim rp-candidate	This command is the global candidate RP configuration command, which is used to configure the information of PIM-SM candidate RP so that it can compete for RP router with other

	candidate RP. The “ no ip pim rp-candidate ” command cancels the configuration of RP.
--	--

3) Configure static RP

Command	Explanation
Global Configuration Mode	
ip pim rp-address <A.B.C.D> [<A.B.C.D/M>]	The command is the multicast group configuration static RP of the globally or multicast address range. The no form of this command will remove the configuration for the static RP.
no ip pim rp-address <A.B.C.D> {<all> <A.B.C.D/M>}	

4) Configure the cache time of kernel multicast route

Command	Explanation
Global Configuration Mode	
ip multicast unresolved-cache aging-time <value>	Configure the cache time of kernel multicast route, the no command restores the default value.
no ip multicast unresolved-cache aging-time	

4. Disable PIM-SM Protocol

Command	Explanation
Interface Configuration Mode	
no ip pim sparse-mode no ip pim multicast-routing (Global configuration mode)	To disable the PIM-SM protocol.

6.3.3 PIM-SM Configuration Examples

As shown in the following figure, add the Ethernet interfaces of SwitchA, SwitchB, SwitchC and SwitchD to corresponding VLAN, and enable PIM-SM Protocol on each VLAN interface.

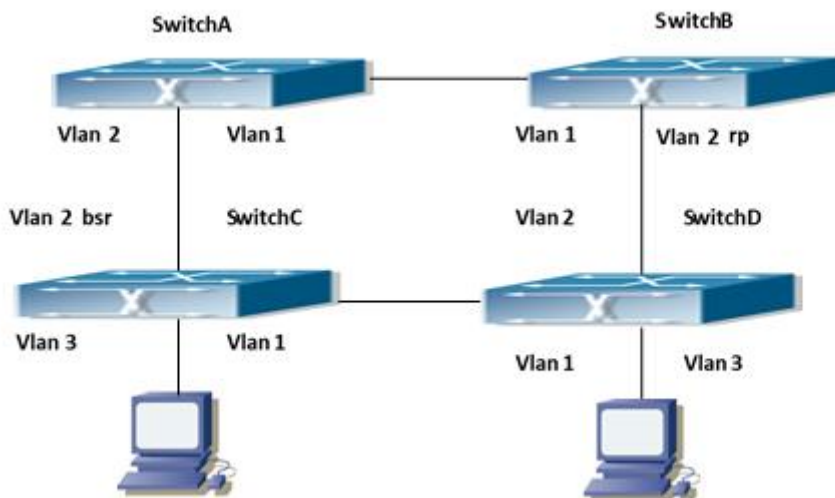

Figure 5- 2 PIM-SM Typical Environment

The configuration procedure for SwitchA, SwitchB, SwitchC and SwitchD is as follows:

(1) Configure SwitchA:

```
Switch(config)#ip pim multicast-routing
Switch(config)#interface vlan 1
Switch(Config-if-Vlan1)# ip address 12.1.1.1 255.255.255.0
Switch(Config-if-Vlan1)# ip pim sparse-mode
Switch(Config-if-Vlan1)#exit
Switch(config)#interface vlan 2
Switch(Config-if-Vlan2)# ip address 13.1.1.1 255.255.255.0
Switch(Config-if-Vlan2)# ip pim sparse-mode
```

(2) Configure SwitchB:

```
Switch(config)#ip pim multicast-routing
Switch(config)#interface vlan 1
Switch(Config-if-Vlan1)# ip address 12.1.1.2 255.255.255.0
Switch(Config-if-Vlan1)# ip pim sparse-mode
Switch(Config-if-Vlan1)#exit
Switch(config)#interface vlan 2
Switch(Config-if-Vlan2)# ip address 24.1.1.2 255.255.255.0
Switch(Config-if-Vlan2)# ip pim sparse-mode
Switch(Config-if-Vlan2)# exit
Switch(config)# ip pim rp-candidate vlan2
```

(3) Configure SwitchC:

```
Switch(config)#ip pim multicast-routing
Switch(config)#interface vlan 1
Switch(Config-if-Vlan1)# ip address 34.1.1.3 255.255.255.0
Switch(Config-if-Vlan1)# ip pim sparse-mode
Switch(Config-if-Vlan1)#exit
Switch(config)#interface vlan 2
Switch(Config-if-Vlan2)# ip address 13.1.1.3 255.255.255.0
Switch(Config-if-Vlan2)# ip pim sparse-mode
Switch(Config-if-Vlan2)#exit
Switch(config)#interface vlan 3
Switch(Config-if-Vlan3)# ip address 30.1.1.1 255.255.255.0
Switch(Config-if-Vlan3)# ip pim sparse-mode
Switch(Config-if-Vlan3)# exit
Switch(config)# ip pim bsr-candidate vlan2 30 10
```

(4) Configure SwitchD:

```
Switch(config)#ip pim multicast-routing
Switch(config)#interface vlan 1
Switch(Config-if-Vlan1)# ip address 34.1.1.4 255.255.255.0
Switch(Config-if-Vlan1)# ip pim sparse-mode
Switch(Config-if-Vlan1)#exit
Switch(config)#interface vlan 2
```

```
Switch(Config-if-Vlan2)# ip address 24.1.1.4 255.255.255.0
Switch(Config-if-Vlan2)# ip pim sparse-mode
Switch(Config-if-Vlan2)#exit
Switch(config)#interface vlan 3
Switch(Config-if-Vlan3)# ip address 40.1.1.1 255.255.255.0
Switch(Config-if-Vlan3)# ip pim sparse-mode
```

At the same time, you should pay attention to the configuration of Unicast Routing Protocol, assure that each device can communicate with each other in the network layer, and be able to implement dynamic routing update in virtue of Unicast Routing Protocol.

6.3.4 PIM-SM Troubleshooting

In configuring and using PIM-SM Protocol, PIM-SM Protocol might not operate normally caused by physical connection or incorrect configuration. Therefore, the user should pay attention to the following issues:

- ☞ Assure that physical connection is correct;
- ☞ Assure the Protocol of Interface and Link is UP (use show interface command);
- ☞ Assure that PIM Protocol is enabled in Global Mode (use ip pim multicast-routing);
- ☞ Assure that PIM-SM is configured on the interface (use ip pim sparse-mode);
- ☞ Multicast Protocol requires RPF Check using unicast routing; therefore the correctness of unicast routing must be assured beforehand;
- ☞ PIM-SM Protocol requires supports by RP and BSR, therefore you should use show ip pim bsr-router first to see if there is BSR information. If not, you need to check if there is unicast routing leading to BSR.
- ☞ Use show ip pim rp-hash command to check if RP information is correct; if there is not RP information, you still need to check unicast routing.

If all attempts including Check are made but the problems on PIM-SM can't be solved yet, then use debug commands such debug pim/debug pim BSR please, and then copy DEBUG information in 3 minutes and send to Technology Service Center.

6.4 MSDP Configuration

6.4.1 Introduction to MSDP

MSDP – Multicast Source Discovery Protocol, is a protocol that can learn information about multicast source in other PIM-SM domain. The RP on which MSDP is configured will advertise the information about the multicast sources in its domain to all the other MSDP entities through SA messages. Thus, all the information about multicast sources in one PIM-SM domain is spread to another. In MSDP, inter-domain information tree is used other than the shared tree. It is required that the multicast routing protocol used for in-domain routing must be PIM-SM.

☞ The work flow for RP in PIM-SM protocol

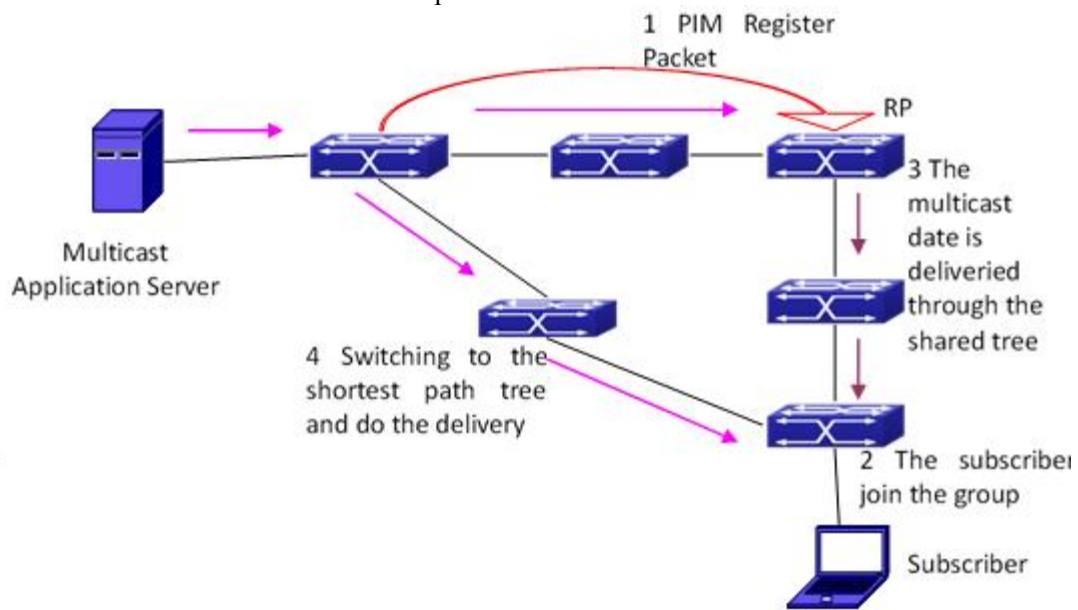

Figure 5-3

6.4.2 Brief Introduction to MSDP Configuration Tasks

1. Configuration of MSDP Basic Function
 - 1) Enabling MSDP (Required)
 - 2) Configuring MSDP entities (Required)
 - 3) Configuring the Connect-Source interface
 - 4) Configuring static RPF entities
 - 5) Configuring Originator RP
 - 6) Configuring TTL value
2. Configuration of MSDP entities
 - 1) Configuring the Connect-Source interface
 - 2) Configuring the descriptive information for MSDP entities
 - 3) Configuring the AS number
 - 4) Configuring the specified mesh group of MSDP
 - 5) Configuring the maximum size for the cache
3. Configurations on delivery of SA packets
 - 1) Configuring filter policies for creation of SA packets
 - 2) Configuring filter rules on how to receive and forward SA packets
 - 3) Configuring SA request packets
 - 4) Configuring filter policies for SA-Request packets
4. Configuration of parameters of SA-cache
 - 1) Configuring SA packets cache

- 2) Configuring the aging time for entries in SA packets cache
- 3) Configuring the maximum size for the cache

6.4.3 Configuration of MSDP Basic Function

All the commands in this section are configured for RP in the PIM-SM domain. These RP will function as the other peer of the MSDP entities.

6.4.3.1 Prerequisites of MSDP Configuration

Before the MSDP basic functions can be configured, the following tasks should be done:

- At least one single cast routing protocol should be configured, in order to connect the network inside the domain and outside
- Configure PIM-SM in order to implement multicast inside the domain

When configuring MSDP basic function, the following information should be ready:

- The IP address of MSDP entities
- Filter policy table

Pay attention: MSDP can not use with Any-cast RP at same time, but configure Any-cast RP of based MSDP protocol.

6.4.3.2 Enabling MSDP

MSDP should be enabled before various MSDP functions can be configured.

1. Enable the MSDP function
2. Configure MSDP

1. Enabling MSDP

Commands	Explanation
Global Configuration Mode	
router msdp no router msdp	To enable MSDP. The no form of this command will disable MSDP globally.

2. Configuration of MSDP parameters

Commands	Explanation
MSDP Configuration Mode	
connect-source < <i>interface-type</i> > < <i>interface-number</i> > no connect-source	To configure the Connect-Source interface for MSDP Peer. The no form of this command will remove the configured Connect-Source interface.
default-rpf-peer < <i>peer-address</i> > / <i>rp-policy</i> < <i>acl-list-number</i> > < <i>word</i> >]	To configure static RPF Peer. The no form of this command will remove the configured RPF

no default-rpf-peer	Peer.
originating-rp < <i>interface-type</i> > < <i>interface-number</i> > no originating-rp	To configure Originator-RP. The no form of this command will remove the configured Originator-RP.
ttl-threshold < <i>ttl</i> > no ttl-threshold	To configure the TTL value. The no form of this command will remove the configured TTL value.

6.4.4 Configuration of MSDP Entities

6.4.4.1 Creation of MSDP Peer

Commands	Explanation
MSDP Configuration Mode	
peer < <i>peer-address</i> > no peer < <i>peer-address</i> >	To create a MSDP Peer. The no form of this command will remove the configured MSDP Peer.

6.4.4.2 Configuration of MSDP parameters

Commands	Explanation
MSDP Peer Configuration Mode	
connect-source < <i>interface-type</i> > < <i>interface-number</i> > no connect-source	To configure the Connect-Source interface for MSDP Peer. The no form of this command will remove the configured Connect-Source interface.
description < <i>text</i> > no description	To configure the descriptive information about the MSDP entities. The no form of this command will remove the configured description.
remote-as < <i>as-num</i> > no remote-as < <i>as-num</i> >	To configure the AS number for MSDP Peer. The no form of this command will remove the configured AS number of MSDP Peer.
mesh-group < <i>name</i> > no mesh-group < <i>name</i> >	To configure an MSDP Peer to join the specified mesh group. The no form of this command will remove the MSDP Peer from the specified mesh group.

6.4.5 Configuration of Delivery of MSDP Packet

Commands	Explanation
----------	-------------

MSDP Configuration Mode	
redistribute [list <acl-list-number acl-name>] no redistribute	To configure the filter rules for creation of SA packets. The no form of this command will remove the configured.
MSDP Configuration Mode or MSDP Peer Configuration Mode	
sa-filter (in out) [list <acl-number acl-name> rp-list <rp-acl-number rp-acl-name>] no sa-filter (in out) [list <acl-number acl-name> rp-list <rp-acl-number rp-acl-name>]	To configure the filter rules for receiving and forwarding SA packets. The no form of this command will remove the configured rules.
MSDP Peer Configuration Mode	
sa-request no sa-request	To configure sending of SA request packets. The no form of this command will disable sending of SA request packets.
MSDP Configuration Mode	
sa-request-filter [list <access-list-number access-list-name>] no sa-request-filter [list <access-list-number access-list-name>]	To configure filter rules for receiving SA request packets. The no form of this command will remove the configured filter rules for SA request packets.

6.4.6 Configuration of Parameters of SA-cache

Commands	Explanation
MSDP Configuration Mode	
cache-sa-state no cache-sa-state	To enable the SA packet cache. To disable the SA packets cache.
MSDP Configuration Mode	
cache-sa-holdtime <150-3600> no cache-sa-holdtime	The aging time for entries in the SA cache. To restore the default aging time configuration.
MSDP Configuration Mode or MSDP Peer Configuration Mode	
cache-sa-maximum <sa-limit> no cache-sa-maximum	To configure the maximum size for the SA cache. To restore the size of the SA cache to the default value.

6.4.7 MSDP Configuration Examples

Example 1: MSDP basic function.

Multicast Configuration:

1. Suppose the multicast server is sending multicast datagram at 224.1.1.1;
2. The designated router – DR, which is connected to the multicast server, encapsulate the multicast datagram in the Register packets and send them to the RP(RP1) in the local domain;
3. The RP unwraps the packets and sends them to all the domain members through the shared tree. The members in the domain can be configured to be or not to be in the shared tree;
4. At the same time, the source RP in the domain, generates a SA – Source Active message, and send it to the MSDP entity – RP2.
5. If there's another member in the same domain with the MSDP entity which is named as RP3, RP3 will distribute the multicast datagram encapsulated in the SA messages to the members of the shared tree, and send join messages to the multicast source. That means RP creates an entry (S, G), and send join messages for (S, G) hop by hop, so that (S, G) can reach the SPT which takes the multicast source as the root across the PIM-SM domain. If there no members in the same domain with MSDP entity – RP2, RP2 will not create the (S, G) entry nor it will join the SPT which takes the multicast source as the root.
6. When the reverse route has been set up, the multicast datagram from the source will be directly delivered to RP3, and RP will forward the datagram to the shared tree. At this time, the router which is closest to the domain members can determine itself whether or not to switch to SPT.

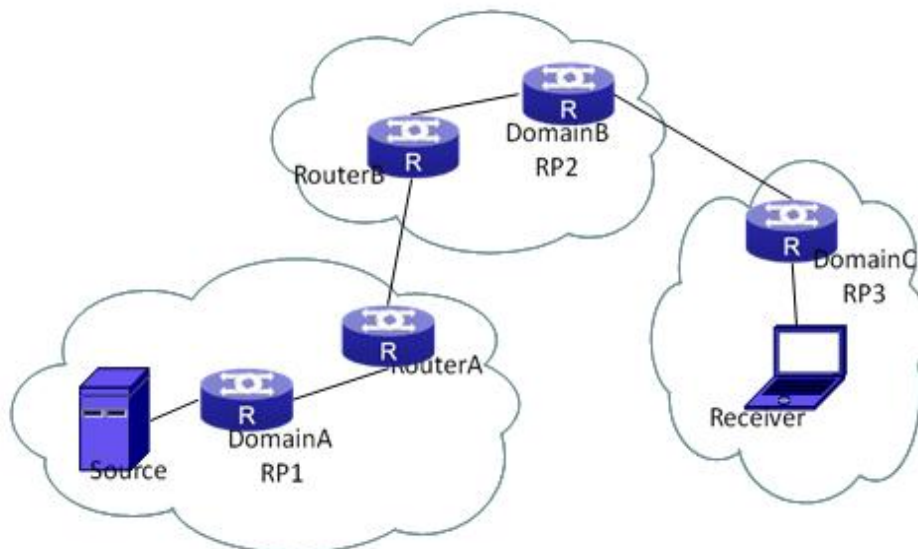

Figure 5- 4 Network Topology for MSDP Entry

Configuration tasks are listed as below:

Prerequisites:

Enable the single cast routing protocol and PIM protocol on every router, and make sure that the inter-domain routing works well and multicasting inside the domain works well.

Suppose the multicast server S in Domain A offers multicast programs at 224.1.1.1. A host in

Domain C named R subscribes this program. Before MSDP is configured C cannot subscribe the multicast program. However, with the following configuration, R is able to receive programs offered by S.

RP1 in Domain A:

```
Switch#config
Switch(config)#interface vlan 1
Switch(Config-if-Vlan1)#ip address 10.1.1.1 255.255.255.0
Switch(Config-if-Vlan1)#exit
Switch(config)#router msdp
Switch(router-msdp)#peer 10.1.1.2
```

Router A in Domain A:

```
Switch#config
Switch(config)#interface vlan 1
Switch(Config-if-Vlan1)#ip address 10.1.1.2 255.255.255.0
Switch(Config-if-Vlan1)#exit
Switch(config)#interface vlan 2
Switch(Config-if-Vlan2)#ip address 20.1.1.2 255.255.255.0
Switch(Config-if-Vlan2)#exit
Switch(config)#router msdp
Switch(router-msdp)#peer 10.1.1.1
Switch(msdp-peer)#exit
Switch(router-msdp)#peer 20.1.1.1
```

Router B in Domain B:

```
Switch#config
Switch(config)#interface vlan 2
Switch(Config-if-Vlan2)#ip address 20.1.1.1 255.255.255.0
Switch(Config-if-Vlan2)#exit
Switch(Config)#interface vlan 3
Switch(Config-if-Vlan3)#ip address 30.1.1.1 255.255.255.0
Switch(Config-if-Vlan3)#exit
Switch(config)#router msdp
Switch(router-msdp)#peer 20.1.1.2
Switch(msdp-peer)#exit
Switch(router-msdp)#peer 30.1.1.2
```

RP2 in Domain B:

```
Switch#config
Switch(config)#interface vlan 3
Switch(Config-if-Vlan3)#ip address 30.1.1.2 255.255.255.0
Switch(config)#interface vlan 4
Switch(Config-if-Vlan4)#ip address 40.1.1.2 255.255.255.0
Switch(Config-if-Vlan4)#exit
```

```
Switch(config)#router msdp
Switch(router-msdp)#peer 30.1.1.1
Switch(config)#router msdp
Switch(router-msdp)#peer 40.1.1.1
```

RP3 in Domain C:

```
Switch(config)#interface vlan 4
Switch(Config-if-Vlan1)#ip address 40.1.1.1 255.255.255.0
Switch(Config-if-Vlan1)#exit
Switch(config)#router msdp
Switch(router-msdp)#peer 40.1.1.2
```

Example 2: Application of MSDP Mesh-Group.

Mesh-Group can be used to reduce flooding of SA messages. The Peers which are meshed in the same domain can be configured as a Mesh-Group. All the members in the same mesh group use a unique group name.

As it is shown in Figure, when Mesh-Group is configured for the four meshed Peers in the same domain, flooding of SA messages reduced remarkably.

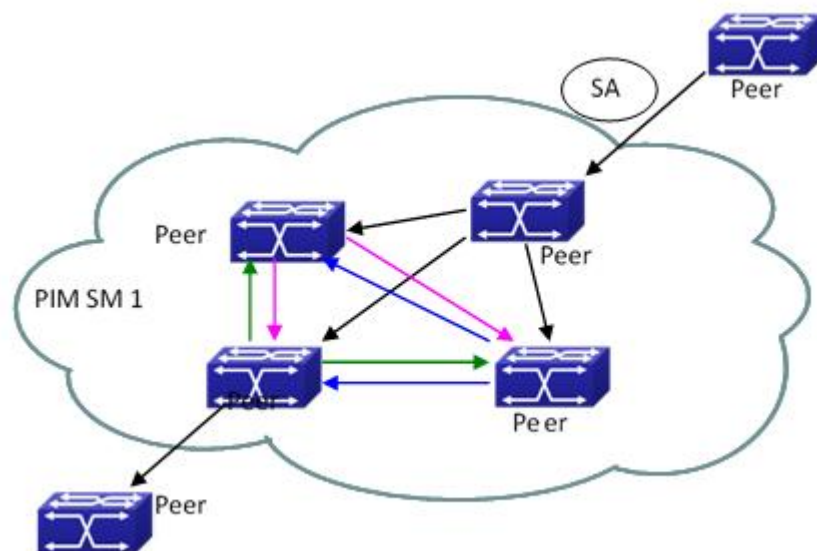

Figure 5-5 Flooding of SA messages

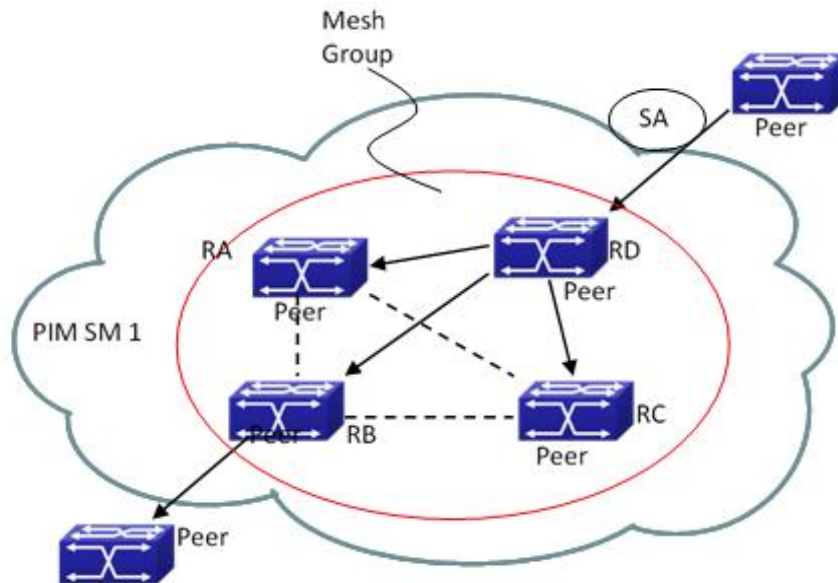

Figure 5-6 Flooding of SA messages with mesh group configuration

Configuration steps are listed as below:

Router A:

```
Switch#config
Switch(config)#interface vlan 1
Switch(Config-if-Vlan1)#ip address 10.1.1.1 255.255.255.0
Switch(Config-if-Vlan1)#exit
Switch(config)#interface vlan 2
Switch(Config-if-Vlan2)#ip address 20.1.1.1 255.255.255.0
Switch(Config-if-Vlan2)#exit
Switch(config)#interface vlan 3
Switch(Config-if-Vlan3)#ip address 30.1.1.1 255.255.255.0
Switch(Config-if-Vlan3)#exit
Switch(config)#router msdp
Switch(router-msdp)#peer 10.1.1.2
Switch(router-msdp)#mesh-group test-1
Switch(msdp-peer)#exit
Switch(router-msdp)#peer 20.1.1.4
Switch(router-msdp)#mesh-group test-1
Switch(msdp-peer)#exit
Switch(router-msdp)#peer 30.1.1.3
Switch(router-msdp)#mesh-group test-1
Switch(msdp-peer)#exit
```

Router B:

```
Switch#config
Switch(config)#interface vlan 1
Switch(Config-if-Vlan1)#ip address 10.1.1.2 255.255.255.0
```



```
Switch(Config-if-Vlan1)#exit
Switch(config)#interface vlan 4
Switch(Config-if-Vlan4)#ip address 40.1.1.2 255.255.255.0
Switch(Config-if-Vlan4)#exit
Switch(config)#interface vlan 6
Switch(Config-if-Vlan6)#ip address 60.1.1.2 255.255.255.0
Switch(Config-if-Vlan6)#exit
Switch(config)#router msdp
Switch(router-msdp)#peer 10.1.1.1
Switch(router-msdp)#mesh-group test-1
Switch(msdp-peer)#exit
Switch(router-msdp)#peer 40.1.1.4
Switch(router-msdp)#mesh-group test-1
Switch(msdp-peer)#exit
Switch(router-msdp)#peer 60.1.1.3
Switch(router-msdp)#mesh-group test-1
```

Router C:

```
Switch#config
Switch(config)#interface vlan 4
Switch(Config-if-Vlan4)#ip address 40.1.1.4 255.255.255.0
Switch(Config-if-Vlan4)#exit
Switch(config)#interface vlan 5
Switch(Config-if-Vlan5)#ip address 50.1.1.4 255.255.255.0
Switch(Config-if-Vlan5)#exit
Switch(config)#interface vlan 6
Switch(Config-if-Vlan6)#ip address 60.1.1.4 255.255.255.0
Switch(Config-if-Vlan6)#exit
Switch(config)#router msdp
Switch(router-msdp)#peer 20.1.1.1
Switch(router-msdp)#mesh-group test-1
Switch(msdp-peer)#exit
Switch(router-msdp)#peer 40.1.1.4
Switch(router-msdp)#mesh-group test-1
Switch(msdp-peer)#exit
Switch(router-msdp)#peer 60.1.1.2
Switch(router-msdp)#mesh-group test-1
```

Router D:

```
Switch#config
Switch(config)#interface vlan 2
Switch(Config-if-Vlan2)#ip address 20.1.1.4 255.255.255.0
Switch(Config-if-Vlan2)#exit
Switch(config)#interface vlan 4
```

```
Switch(Config-if-Vlan1)#ip address 40.1.1.4 255.255.255.0
Switch(Config-if-Vlan1)#exit
Switch(config)#interface vlan 5
Switch(Config-if-Vlan5)#ip address 50.1.1.4 255.255.255.0
Switch(Config-if-Vlan5)#exit
Switch(config)#router msdp
Switch(router-msdp)#peer 20.1.1.1
Switch(router-msdp)#mesh-group test-1
Switch(msdp-peer)#exit
Switch(router-msdp)#peer 40.1.1.2
Switch(router-msdp)#mesh-group test-1
Switch(msdp-peer)#exit
Switch(router-msdp)#peer 50.1.1.3
Switch(router-msdp)#mesh-group test-1
```

6.4.8 MSDP Troubleshooting

When MSDP is being configured, it may not function because of the physical link not working or configuration mistakes. Attention should be paid to the following items in order to make MSDP work:

- ☞ Make sure the physical link works well
- ☞ Make sure inner-domain and inter-domain routing works
- ☞ Make sure PIM-SM is applied in every domain as the inner-domain routing protocol, and configuration for PIM-SM works well
- ☞ Make sure MSDP is enabled, and the link status of the MSDP enabled Peer is UP
- ☞ Use the command **show msdp global** to check whether the MSDP configuration is correct

If the MSDP problems cannot be solved through all the methods provided above, please issue the command **debug msdp** to get the debugging messages within three minutes, and send them to the technical service center of our company.

6.5 ANYCAST RP Configuration

6.5.1 Introduction to ANYCAST RP

Anycast RP is a technology based on PIM protocol, which provides redundancy in order to recover as soon as possible once an RP becomes unusable.

The kernel concept of Anycast RP is that the RP addresses configured all over the whole network exist on multiple multicast servers (the most common situation is that every device providing ANYCAST RP uses LOOPBACK interface, and using the longest mask to configure RP addresses on this interface), while the unicast routing algorithm will make sure that PIM routers can always find the nearest RP, thus , providing a shorter and faster way to find RP in a

larger network., Once an RP being used becomes unusable, the unicast routing algorithm will ensure that the PIM router can find a new RP path fast enough to recover the multicast server in time. Multiple RP will cause a new problem that is if the multicast source and the receivers are registered to different RP, some receivers will not be able to receive data of multicast source (obviously, the register messages only prefer the nearest RP). So, in order to keep the communication between all RP, Anycast RP defines that the nearest RP to the multicast source should forward the source register messages to all the other RP to guarantee that all joiners of the RP can find the multicast source.

The method to realize the PIM-protocol-based Anycast RP is that: maintaining an ANYCAST RP list on every switch configured with Anycast RP and using another address as the label to identify each other. When one Anycast RP device receives a register message, it will send the register message to other Anycast RP devices while using its own address as the source address, to notify all the other devices of the original destination.

6.5.2 ANYCAST RP Configuration Task

1. Enable ANYCAST RP v4 function
2. Configure ANYCAST RP v4

1. Enable ANYCAST RP v4 function

Command	Explanation
Global Configuration Mode	
ip pim anycast-rp no ip pim anycast-rp	Enable ANYCAST RP function. (necessary) No operation will globally disable ANYCAST RP function.

2. Configure ANYCAST RP v4

- (1) Configure the RP candidate

Command	Explanation
Global Configuration Mode	
ip pim rp-candidate {vlan<vlan-id> loopback<index> <ifname>} [<A.B.C.D>] [<priority>] no ip pim rp-candidate	Now, the PIM-SM has allowed the Loopback interface to be a RP candidate.(necessary) Please pay attention to that, ANYCAST RP protocol can configure the Loopback interface or a regular three-layer VLAN interface to be the RP candidate. In make sure that PIM routers in the network can find where the RP locates, the RP candidate interface should be added into the router. No operation will cancel the RP candidate configuration on this router.

- (2) Configure self-rp-address (the RP address of this router)

Command	Explanation

Global Configuration Mode	
<pre>ip pim anycast-rp self-rp-address A.B.C.D no ip pim anycast-rp self-rp-address</pre>	<p>Configure the self-rp-address of this router (as a RP). This address can be used to exclusively identify this router when communicating with other RP.</p> <p>the effect of self-rp-address refers to two respects:</p> <ol style="list-style-type: none"> 1 Once this router (as a RP) receives the register message from DR unicast, it needs to forward the register message to all the other RP in the network, notifying them of the state of source (S.G). While forwarding the register message, this router will change the source address of it into self-rp-address. 2 Once this router(as a RP) receives a register message from other RP unicast, such as a register message whose destination is the self-rp-address of this router, it will create (S,G) state and send back a register-stop message, whose destination address is the source address of the register message. <p>Pay attention: self-rp-address has to be the address of a three-layer interface on this router, but the configuration is allowed to be done with the absence of the interface. The self-rp-address should be unique.</p> <p>No operation will cancel the self-rp-address which is used to communicate with other RPs by this router (as a RP).</p>

(3) Configure other-rp-address (other RP communication addresses)

Command	Explanation
Global Configuration Mode	
<pre>ip pim anycast-rp <anycast-rp-addr> <other-rp-addr> no ip pim anycast-rp <anycast-rp-addr> <other-rp-addr></pre>	<p>Configure anycast-rp-addr on this router (as a RP). This unicast address is actually the RP address configured on multiple RP in the network, in accordance with the address of RP candidate interface (or Loopback interface).</p> <p>The effect of anycast-rp-addr includes:</p> <ol style="list-style-type: none"> 1 Although more than one anycast-rp-addr addresses are allowed to be configured, only the one having the same address with the currently configured RP candidate address will take effect. Only after that, can the

	<p>other-rp-address in accordance with this anycast-rp-addr take effect.</p> <p>2 The configuration is allowed to be done with the absence of the interface in accordance with the anycast-rp-addr.</p> <p>Configure on this router (as a RP) the other-rp-addresses of other RP communicating with it. This unicast address identifies other RP and is used in the communication with local routers.</p> <p>The effect of other-rp-address refers to two respects:</p> <p>1 Once this router (as a RP) receives the register message from a DR unicast, it should forward it to other RP in the network to notify all the RP in the network of the source (S.G) state. While forwarding, the router will change the destination address of the register message into other-rp-address.</p> <p>2 Multiple other-rp-addresses can be configured in accordance with one anycast-rp-addr, Once the register message from a DR is received, it should be forwarded to all of these other RP one by one.</p> <p>No operation will cancel an other-rp-address communicating with this router.</p>
--	--

6.5.3 ANYCAST RP Configuration Examples

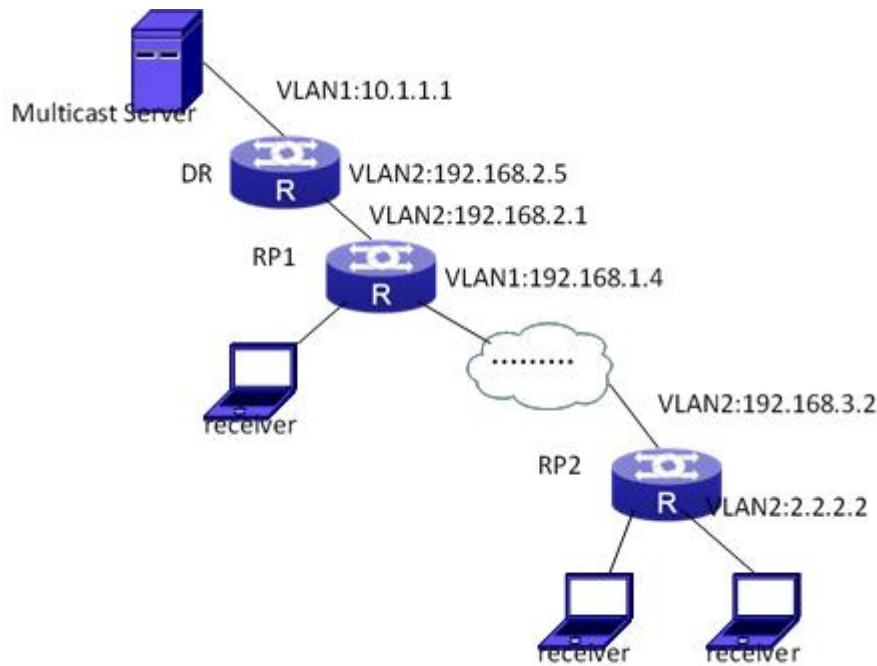

Figure 5-7 The ANYCAST RP v4 function of the router

As shown in the Figure, the overall network environment is PIM-SM, which provides two routers supporting ANYCAST RP, RP1 and RP2. Once multicast data from the multicast source server reaches the DR, the DR will send a multicast source register message to the nearest RP unicast according to the unicast routing algorithm, which is RP1 in this example. When RP1 receives the register message from the DR, besides redistributing to the shared tree according to the orders who already join it, it will forward the multicast register message to RP2 to guarantee that all orders that already join RP2 can find the multicast source. Since there is an ANYCAST list maintained on router RP1 that has been configured with ANYCAST RP, and since this list contains the unicast addresses of all the other RP in the network, when the RP1 receives the register message, it can use the self-r-address, which identifies itself as the source address to forward the register message to RP2. The cloud in the Figure represents the PIM-SM network operation between RP1 and RP2.

The following is the configuration steps:

RP1 Configuration:

```
Switch#config
Switch(config)#interface loopback 1
Switch(Config-if-Loopback1)#ip address 1.1.1.1 255.255.255.255
Switch(Config-if-Loopback1)#exit
Switch(config)#ip pim rp-candidate loopback1
Switch(config)#ip pim bsr-candidate vlan 1
Switch(config)#ip pim multicast-routing
Switch(config)#ip pim anycast-rp
Switch(config)#ip pim anycast-rp self-rp-address 192.168.2.1
Switch(config)#ip pim anycast-rp 1.1.1.1 192.168.3.2
```

RP2 Configuration:

```
Switch#config
Switch(config)#interface loopback 1
Switch(Config-if-Loopback1)#ip address 1.1.1.1 255.255.255.255
Switch(Config-if-Loopback1)#exit
Switch(config)#ip pim rp-candidate loopback1
Switch(config)#ip pim multicast-routing
Switch(config)#ip pim anycast-rp
Switch(config)#ip pim anycast-rp self-rp-address 192.168.3.2
Switch(config)#ip pim anycast-rp 1.1.1.1 192.168.2.1
```

6.5.4 ANYCAST RP Troubleshooting

When configuring and using ANYCAST RP function, the ANYCAST RP might work abnormally because of faults in physical connections, configurations or something others. So, the users should pay attention to the following points:

- ☞ The physical connections should be guaranteed to be correct
- ☞ The PIM-SM protocol should be guaranteed to operate normally
- ☞ The ANYCAST RP should be guaranteed to be enabled in Global configuration mode
- ☞ The self-rp-address should be guaranteed to be configured correctly in Global configuration mode
- ☞ The other-rp-address should be guaranteed to be configured correctly in Global configuration mode
- ☞ All the interface routers should be guaranteed to be correctly added, including the loopback interface as a RP
- ☞ Use “**show ip pim anycast rp status**” command to check whether the configuration information of ANYCAST RP is correct

If the problems of ANYCAST still cannot be solved after checking, please use debug commands like “**debug pim anycast-rp**”, then copy the DEBUG information within three minutes and send it to the technical service center of our company.

6.6 PIM-SSM

6.6.1 Introduction to PIM-SSM

Source Specific Multicast (PIM-SSM) is a new kind of multicast service protocol. With PIM-SSM, a multicast session is distinguished by the multicast group address and multicast source address. In SSM, hosts can be added into the multicast group manually and efficiently like the traditional PIM-SM, but leave out the shared tree and RP management in PIM-SM. In SSM, SPT tree will be constructed with (S, G). G for the multicast group address and S for the source address of the multicast which sends datagram to G. (S, G) in a pair is named as a channel of SSM. SSM

serves best for the application of multicast service which is from one station to many ones, for example, the network sports video channel, and the news channel. By default, the multicast group address of SSM is limited between 232.0.0.0 and 232.255.255.255. However this address range can be extended according to actual situations.

6.6.2 PIM-SSM Configuration Task List

Command	Explanation
Global Configuration Mode	
ip multicast ssm {default range <access-list-number >}	To configure the address range for pim-ssm. The no form command will disable the configuration.
no ip multicast ssm	

6.6.3 PIM-SSM Configuration Examples

As the figure shows, ethernet interfaces from SwitchA, SwitchB, SwitchC, and SwitchD are configured to be in separate VLANs. And PIM-SSM is enabled globally by enabling the PIM-SM or PIM-DM protocol on the VLAN interfaces. Take PIM-SM for example.

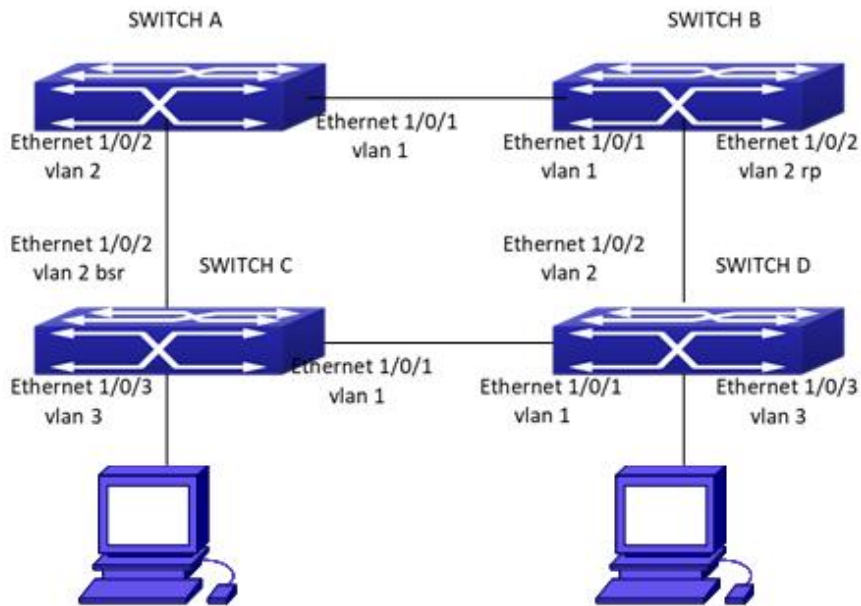

Figure 5-8 PIM-SSM typical environment

Configurations of SwitchA, SwitchB, SwitchC, and SwitchD are shown as below.

(1) Configuration of SwitchA.

```
Switch(config)#ip pim multicast-routing
Switch(config)#interface vlan 1
Switch(Config-If-Vlan1)# ip pim sparse-mode
Switch(Config-If-Vlan1)#exit
```



```
Switch(config)#interface vlan 2
Switch(Config-If-Vlan2)# ip pim sparse-mode
Switch(Config-If-Vlan2)#exit
Switch(config)#access-list 1 permit 224.1.1.1 0.0.0.255
Switch(config)#ip multicast ssm range 1
(2) Configuration of SwitchB.
Switch(config)#ip pim multicast-routing
Switch(config)#interface vlan 1
Switch(Config-If-Vlan1)# ip pim sparse-mode
Switch(Config-If-Vlan1)#exit
Switch(config)#interface vlan 2
Switch(Config-If-Vlan2)# ip pim sparse-mode
Switch(Config-If-Vlan2)# exit
Switch(config)# ip pim rp-candidate vlan2
Switch(config)#access-list 1 permit 224.1.1.1 0.0.0.255
Switch(config)#ip multicast ssm range 1
(3) Configuration of SwitchC.
Switch(config)#ip pim multicast-routing
Switch(config)#interface vlan 1
Switch(Config-If-Vlan1)# ip pim sparse-mode
Switch(Config-If-Vlan1)#exit
Switch(config)#interface vlan 2
Switch(Config-If-Vlan2)# ip pim sparse-mode
Switch(Config-If-Vlan2)#exit
Switch(config)#interface vlan 3
Switch(Config-If-Vlan3)# ip pim sparse-mode
Switch(Config-If-Vlan3)# exit
Switch(config)# ip pim bsr-candidate vlan2 30 10
Switch(config)#access-list 1 permit 224.1.1.1 0.0.0.255
Switch(config)#ip multicast ssm range 1
(4) Configuration of SwitchD.
Switch(config)#ip pim multicast-routing
Switch(config)#interface vlan 1
Switch(Config-If-Vlan1)# ip pim sparse-mode
Switch(Config-If-Vlan1)#exit
Switch(config)#interface vlan 2
Switch(Config-If-Vlan2)# ip pim sparse-mode
Switch(Config-If-Vlan2)#exit
Switch(config)#interface vlan 3
Switch(Config-If-Vlan3)# ip pim sparse-mode
Switch(Config-If-Vlan3)#exit
Switch(config)#access-list 1 permit 224.1.1.1 0.0.0.255
Switch(config)#ip multicast ssm range 1
```

6.6.4 PIM-SSM Troubleshooting

In configuring and using PIM-SSM Protocol, PIM-SSM Protocol might not operate normally caused by physical connection or incorrect configuration. Therefore, the user should pay attention to the following issues:

- 👉 Assure that physical connection is correct;
- 👉 Assure the Protocol of Interface and Link is UP (use **show interface** command);
- 👉 Assure that PIM Protocol is enabled in Global Mode (use **ip pim multicast-routing**);
- 👉 Assure that PIM-SSM is configured on the interface (use **ip pim sparse-mode**);
- 👉 Assure that SSM is configured in Global Mode;
- 👉 Multicast Protocol requires RPF check using unicast routing, therefore the correctness of unicast routing must be assured beforehand.

If all attempts including check are made but the problems on PIM-SSM can't be solved yet, then use debug commands such **debug pim event/debug pim packet** please, and then copy DEBUG information in 3 minutes and send to Technology Service Center.

6.7 DVMRP

6.7.1 Introduction to DVMRP

DVMRP Protocol, namely, is “Distance Vector Multicast Routing Protocol”. It is a Multicast Routing Protocol in dense mode, which sets up a Forward Broadcast Tree for each source in a manner similar to RIP, and sets up a Truncation Broadcast Tree, i.e. the Shortest Path Tree to the source, for each source through dynamic Prune/Graft.

Some of the important features of DVMRP are:

1. The routing exchange used to determine reverse path checking information is based on distance vector (in a manner similar to RIP)
2. Routing exchange update occurs periodically (the default is 60 seconds)
3. TTL upper limit = 32 hops (and that RIP is 16)
4. Routing update includes net mask and supports CIDR

In comparison with Unicast routing, Multicast routing is a kind of reverse routing (that is, what you are interested in is where the packets are from but not where they go), thus the information in DVMRP routing table is used to determine if an input Multicast packet is received at the correct interface. Otherwise, the packet will be discarded to prevent Multicast circulation.

The check which determines if the packet gets to the correct interface is called RPF check. When some Multicast data packets get to some interface, it will determine the reverse path to the source network by looking up DVMRP router table. If the interface data packets get to is the one which is used to send Unicast message to the source, then the reverse path check is correct, and the data packets are forwarded out from all downstream interfaces. If not, then probably there is failure, and the Multicast packet is discarded.

Since not all switches support Multicast, DVMRP supports tunnel multicast communication, tunnel is a method to send multicast data report among DVMRP switches separated by switches which don't support multicast routing. Multicast data packets are encapsulated in unicast data packets and directly sent to the next switch which supports multicast. DVMRP Protocol treats tunnel interface and general physical interface equally.

If two or more switches are connected to a multi-entrance network, it is likely to transmit more than one copy of a data packet to the sub-network. Thus a specified transmitter must be appointed. DVMRP achieves this goal by making use of routing exchange mechanism; when two switches on the multi-entrance network exchange routing information, they will be aware of the routing distance from each other to the source network, thus the switch with the shortest distance to the source network will become the specified transmitter of the sub-network. If some have the same distance, then the one with the lowest IP prevails.

After some interface of the switch is configured to Function DVMRP Protocol, the switch will multicast Probe message to other DVMRP switches on this interface, which is used to find neighbors and detect the capabilities of each other. If no Probe message from the neighbor is received until the neighbor is timed out, then this neighbor is considered missing.

In DVMRP, source network routing selection message are exchanged in a basic manner same to RIP. That is, routing report message is transmitted among DVMRP neighbors periodically (the default is 60 seconds). The routing information in DVMRP routing selection table is used to set up source distribution tree, i.e. to determine by which neighbor it passes to get to the source transmitting multicast packet; the interface to this neighbor is called upstream interface. The routing report includes source network (use net mask) address and the hop entry for routing scale.

In order to finish transmission correctly, every DVMRP switch needs to know which downstream switches need to receive multicast packet from some specific source network through it. After receiving packets from some specific source, DVMRP switch firstly will broadcast these multicast packets from all downstream interfaces, i.e. the interfaces on which there are other DVMRP switches which have dependence on the specific source. After receiving Prune message from some downstream switch on the interface, it will prune this switch. DVMRP switch uses poison reverse to notify the upstream switch for some specific source: "I am your downstream." By adding infinity (32) to the routing distance of some specific source it broadcasts, DVMRP switch responds to the source upstream exchange to fulfill poison reverse. This means distance correct value is 1 to $2 * \text{infinity} (32) - 1$ or 1 to 63, 1 to 63 means it can get to source network, 32 means source network is not arrival, 33 to 63 means the switch which generates the report message will receive multicast packets from specific source depending on upstream router.

6.7.2 DVMRP Configuration Task List

1. Globally enable and disable DVMRP (Required)
2. Configure Enable and Disable DVMRP Protocol at the interface (Required)
3. Configure DVMRP Sub-parameters (Optional)
 - Configure DVMRP interface parameters
 - 1) Configure the delay of transmitting report message on DVMRP interface and the message number each time it transmits

- 2) Configure metric value of DVMRP interface
 - 3) Configure if DVMRP is able to set up neighbors with DVMRP routers which can not Prune/Graft
4. Configure DVMRP tunnel

1. Globally enable DVMRP Protocol

The basic configuration to function DVMRP routing protocol on Layer 3 switch is very simple. Firstly it is required to turn on DVMRP switch globally.

Command	Explanation
Global Mode	
[no] ip dvmrp multicast-routing	Globally enable DVMRP Protocol, the “ no ip dvmrp multicast-routing ” command disables DVMRP Protocol globally. (Required)

2. Enable DVMRP Protocol on the interface

The basic configuration to function DVMRP routing protocol on Layer 3 switch is very simple. After globally enabling DVMRP Protocol, it is required to turn on DVMRP switch under corresponding interface.

Command	Explanation
Interface Configuration Mode	
ip dvmrp no ip dvmrp	Enable DVMRP Protocol on the interface, the “ no ip dvmrp ” command disables DVMRP Protocol on the interface.

3. Configure DVMRP Sub-parameters

(1) Configure DVMRP Interface Parameters

- 1) Configure the delay of transmitting report message on DVMRP interface and the message number each time it transmits
- 2) Configure metric value of DVMRP interface
- 3) Configure if DVMRP is able to set up neighbors with DVMRP routers which can not Prune/Graft

Command	Explanation
Interface Configuration Mode	
ip dvmrp output-report-delay <delay_val> [<burst_size>] no ip dvmrp output-report-delay	Configure the delay of transmitting DVMRP report message on interface and the message number each time it transmits, the “ no ip dvmrp output-report-delay ” command restores default value.
ip dvmrp metric <metric_val> no ip dvmrp metric	Configure interface DVMRP report message metric value; the “ no ip dvmrp metric ” command restores default value.
ip dvmrp reject-non-pruners no ip dvmrp reject-non-pruners	Configure the interface rejects to set up neighbor relationship with non pruning/grafting DVMRP

	router. The “ no ip dvmrp reject-non-pruners ” command restores to being able to set up neighbor ship.
--	---

4. Configure DVMRP Tunnel

Command	Explanation
Interface Configuration Mode	
ip dvmrp tunnel <index> <src-ip> <dst-ip> no ip dvmrp tunnel {<index> <src-ip> <src-ip> <dst-ip>}	This command configures a DVMRP tunnel; the “ no ip dvmrp tunnel {<index> <src-ip> <dst-ip>}” command deletes a DVMRP tunnel.

6.7.3 DVMRP Configuration Examples

As shown in the following figure, add the Ethernet interfaces of Switch A and Switch B to corresponding VLAN, and enable DVMRP on each VLAN interface.

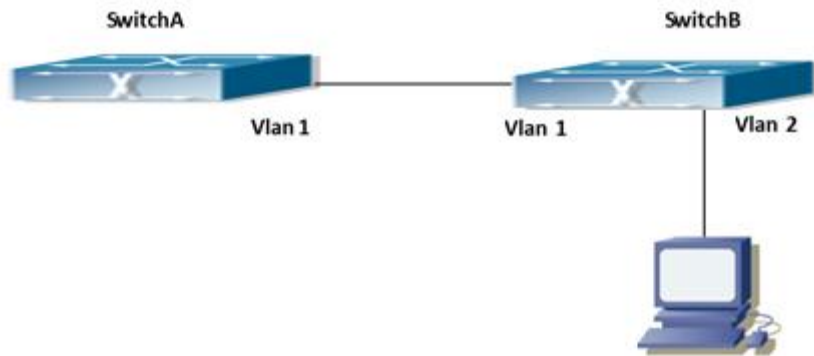

Figure 5-9 DVMRP Network Topology Diagram

The configuration procedure for SwitchA and SwitchB is as follows:

(1) Configure SwitchA:

```
Switch (config)#ip dvmrp multicast-routing
Switch (config)#interface vlan 1
Switch(Config-if-Vlan1)# ip address 10.1.1.1 255.255.255.0
Switch(Config-if-Vlan1)# ip dvmrp enable
```

(2) Configure SwitchB:

```
Switch (config)#ip dvmrp multicast-routing
Switch (config)#interface vlan 1
Switch(Config-if-Vlan1)# ip address 12.1.1.2 255.255.255.0
Switch(Config-if-Vlan1)# ip dvmrp enable
Switch(Config-if-Vlan1)#exit
Switch (config)#interface vlan 2
Switch(Config-if-Vlan2)# ip address 20.1.1.1 255.255.255.0
Switch(Config-if-Vlan2)# ip dvmrp
```

Since DVMRP itself does not rely on Unicast Routing Protocol, it is not necessary to configure Unicast Routing Protocol. This is the difference from PIM-DM and PIM-SM.

6.7.4 DVMRP Troubleshooting

In configuring and using DVMRP Protocol, DVMRP Protocol might not operate normally caused by physical connection or incorrect configuration. Therefore, the user should pay attention to the following issues:

- ☞ Firstly to assure that physical connection is correct;
- ☞ Next, to assure the Protocol of Interface and Link is UP (use **show interface** command);
- ☞ Please check if the correct IP address is configured on the interface (use **ip address** command);
- ☞ Afterwards, enable DVMRP Protocol on the interface (use **ip dvmrp** command and **ip dm multicast-routing** command);
- ☞ Multicast Protocol requires RPF Check using unicast routing; therefore the correctness of unicast routing must be assured beforehand. (DVMRP uses its own unicast table, please use **show ip dvmrp route** command to look up).

If all attempts including Check are made but the problems on DVMRP can't be solved yet, then please use commands such as debug DVMRP, and then copy DEBUG information in 3 minutes and send to Technology Service Center.

6.8 DCSCM

6.8.1 Introduction to DCSCM

DCSCM (Destination control and source control multicast) technology mainly includes three aspects, i.e. Multicast Packet Source Controllable, Multicast User Controllable and Service-Oriented Priority Strategy Multicast.

The Multicast Packet Source Controllable technology of Security Controllable Multicast technology is mainly processed in the following manners:

1. On the edge switch, if source under-control multicast is configured, then only multicast data from specified group of specified source can pass.
2. For RP switch in the core of PIM-SM, for REGISTER information out of specified source and specified group, REGISTER_STOP is transmitted directly and table entry is not allowed to set up. (This task is implemented in PIM-SM model).

The implement of Multicast User Controllable technology of Security Controllable Multicast technology is based on the control over IGMP report message sent out by the user, thus the model being controlled is IGMP snooping and IGMPmodel, of which the control logic includes the following three, i.e. to take control based on VLAN+MAC address transmitting packets, to take control based on IP address of transmitting packets and to take control based on the port where messages enter, in which IGMP snooping can use the above three methods to take control simultaneously, while since IGMP model is located at layer 3, it only takes control over

the IP address transmitting packets.

The Service-Oriented Priority Strategy Multicast of Security Controllable technology adopts the following mode: for multicast data in limit range, set the priority specified by the user at the join-in end so that data can be sent in a higher priority on TRUNK port, consequently guarantee the transmission is processed in user-specified priority in the entire network.

6.8.2 DCSCM Configuration Task List

1. Source Control Configuration
2. Destination Control Configuration
3. Multicast Strategy Configuration

1. Source Control Configuration

Source Control Configuration has three parts, of which the first is to enable source control.

The command of source control is as follows:

Command	Explanation
Global Configuration Mode	
[no] ip multicast source-control (Required)	Enable source control globally, the “ no ip multicast source-control ” command disables source control globally. It is noticeable that, after enabling source control globally, all multicast packets are discarded by default. All source control configuration can not be processed until that it is enabled globally, while source control can not be disabled until all configured rules are disabled.

The next is to configure the rule of source control. It is configured in the same manner as for ACL, and uses ACL number of 5000-5099, every rule number can be used to configure 10 rules. It is noticeable that these rules are ordered, the front one is the one which is configured the earliest. Once the configured rules are matched, the following rules won't take effect, so rules of globally allow must be put at the end. The commands are as follows:

Command	Explanation
Global Configuration Mode	
[no] access-list <5000-5099> {deny permit} ip {{<source> <source-wildcard>}}{host-source <source-host-ip>} any-source} {{<destination> <destination-wildcard>}}{host-destination <destination-host-ip>} any-destination } }	The rule used to configure source control. This rule does not take effect until it is applied to specified port. Using the NO form of it can delete specified rule.

The last is to configure the configured rule to specified port.

Note: If the rules being configured will occupy the table entries of hardware, configuring too many rules will result in configuration failure caused by bottom table entries being full, so we suggest user to use the simplest rules if possible. The configuration rules are as follows:

Command	Explanation
Port Configuration Mode	
[no] ip multicast source-control access-group <5000-5099>	Used to configure the rules source control uses to port, the NO form cancels the configuration.

2. Destination Control Configuration

Like source control configuration, destination control configuration also has three steps.

First, enable destination control globally. Since destination control need to prevent unauthorized user from receiving multicast data, the switch won't broadcast the multicast data it received after configuring global destination control. Therefore, It should be avoided to connect two or more other Layer 3 switches in the same VLAN on a switch on which destination control is enabled. The configuration commands are as follows:

Command	Explanation
Global Configuration Mode	
[no] multicast destination-control (required)	Globally enable IPv4 and IPv6 destination control. The no operation of this command will globally disable destination control. All of the other configuration can only take effect after globally enabled. The next is configuring destination control rules, which are similar.

Next is to configure the multicast destination control profile rule list and use the profile-id number of 1-50.

Command	Explanation
Global Configuration Mode	
profile-id <1-50> {deny permit} {{<source/M> } {host-source <source-host-ip> (range <2-65535>) }{any-source} {{<destination/M>} {host-destination <destination-host-ip> (range <2-255>) }{any-destination} no profile-id <1-50>	Configure the destination control profile rule. The no command deletes it.

Then configure destination control rule. It is similar to source control, except to use ACL No. of 6000-7999.

Command	Explanation
Global Configuration Mode	
[no] access-list <6000-7999> {{{add delete} profile-id WORD} {{deny permit} (ip)	The rule used to configure destination control. This rule does not take effect

<pre> {{<source/M> }}{{host-source <source-host-ip> (range <2-65535>)}}{{any-source}} {{<destination/M>}}{{host-destination <destination-host-ip> (range <2-255>)}}{{any-destination}} </pre>	<p>until it is applied to source IP or VLAN-MAC and port. Using the NO form of it can delete specified rule.</p>
---	--

The last is to configure the rule to specified source IP, source VLAN MAC or specified port. It is noticeable that, due to the above situations, these rules can only be used globally in enabling IGMP-SNOOPING. And if IGMP-SNOOPING is not enabled, then only source IP rule can be used under IGMP Protocol. The configuration commands are as follows:

Command	Explanation
Port Configuration Mode	
[no] ip multicast destination-control access-group <6000-7999>	Used to configure the rules destination control uses to port, the NO form cancels the configuration.
Global Configuration Mode	
[no] ip multicast destination-control <1-4094> <macaddr> access-group <6000-7999>	Used to configure the rules destination control uses to specify VLAN-MAC, the NO form cancels the configuration.
[no] ip multicast destination-control <IPADDRESS/M> access-group <6000-7999>	Used to configure the rules destination control uses to specified IP address/net mask, the NO form cancels the configuration.

3. Multicast Strategy Configuration

Multicast Strategy uses the manner of specifying priority for specified multicast data to achieve and guarantee the effects the specific user requires. It is noticeable that multicast data can not get a special care all along unless the data are transmitted at TRUNK port. The configuration is very simple, it has only one command, i.e. to set priority for the specified multicast. The commands are as follows:

Command	Explanation
Global Configuration Mode	
[no] ip multicast policy <IPADDRESS/M> <IPADDRESS/M> cos <priority>	Configure multicast strategy, specify priority for sources and groups in specific range, and the range is <0-7>.

6.8.3 DCSCM Configuration Examples

1. Source Control

In order to prevent an Edge Switch from putting out multicast data ad asbitsium, we configure Edge Switch so that only the switch at port Ethernet1/0/5 is allowed to transmit multicast, and the data group must be 225.1.2.3. Also, switch connected up to port Ethernet1/0/10 can transmit multicast data without any limit, and we can make the following configuration.

```
EC(config)#access-list 5000 permit ip any host 225.1.2.3
```

```
EC(config)#access-list 5001 permit ip any any
EC(config)#ip multicast source-control
EC(config)#interface ethernet1/0/5
EC(Config-If-Ethernet1/0/5)#ip multicast source-control access-group 5000
EC(config)#interface ethernet1/0/10
EC(Config-If-Ethernet1/0/10)#ip multicast source-control access-group 5001
```

2. Destination Control

We want to limit users with address in 10.0.0.0/8 network segment from entering the group of 238.0.0.0/8, so we can make the following configuration:

Firstly enable IGMP snooping in the VLAN it is located (Here it is assumed to be in VLAN2)

```
EC(config)#ip igmp snooping
EC(config)#ip igmp snooping vlan 2
```

After that, configure relative destination control access-list, and configure specified IP address to use that access-list.

```
Switch(config)#access-list 6000 deny ip any 238.0.0.0 0.255.255.255
Switch(config)#access-list 6000 permit ip any any
Switch(config)#multicast destination-control
Switch(config)#ip multicast destination-control 10.0.0.0/8 access-group 6000
```

In this way, users of this network segment can only join groups other than 238.0.0.0/8.

Or configure the destination control access-list by adding the profile list.

```
Switch (config)#profile-id 1 deny ip any 238.0.0.0 0.255.255.255
Switch (config)#access-list 6000 add profile-id 1
Switch (config)#multicast destination-control
Switch (config)#ip multicast destination-control 10.0.0.0/8 access-group 6000
```

3. Multicast strategy

Server 210.1.1.1 is distributing important multicast data on group 239.1.2.3, we can configure on its join-in switch as follows:

```
Switch(config)#ip multicast policy 210.1.1.1/32 239.1.2.3/32 cos 4
```

In this way, the multicast stream will have a priority of value 4 (Usually this is pretty higher, the higher possible one is protocol data; if higher priority is set, when there is too many multicast data, it might cause abnormal behavior of the switch protocol) when it gets to other switches through this switch.

6.8.4 DCSCM Troubleshooting

The effect of DCSCM module itself is similar to ACL, and the problems occurred are usually related to improper configuration. Please read the descriptions above carefully. If you still can not determine the cause of the problem, please send your configurations and the effects you expect to the after-sale service staff of our company.

6.9 IGMP

6.9.1 Introduction to IGMP

IGMP (Internet Group Management Protocol) is the protocol in TCP/IP protocol family which is responsible for IP multicast member management. It is used to set up and maintain multicast group member relationship between IP host and its neighbor multicast switches. IGMP does not include the spread and maintenance of relation information of group members among multicast switches, this work is accomplished by each multicast routing protocol. All hosts participating in multicast must implement IGMP protocol.

Hosts participating IP multicast can join in and exit multicast group at any location, any time and without limit of member total. Multicast switch does not need and not likely to save all relationships of all hosts. It only gets to know if there are receivers of some multicast group, i.e. group member, on the network segment each interface connects to. And the host only needs to save which multicast groups it joined.

IGMP is asymmetric between host and router: the host needs to respond the IGMP query messages of multicast switches, i.e. to report message response in membership; the switch sends out membership query messages periodically, and then determine if there are hosts of some specific group joining in the sub-network it belongs to based on the received response message, and send out query of specific group (IGMP version2) when receiving the report of a host exiting the group to determine if there exists no member in some specific group.

Up to now, there are three versions of IGMP: IGMP version1 (defined by RFC1112), IGMP version2 (defined by RFC2236) and IGMP version3 (defined by RFC3376).

The main improvements of IGMP version2 over version1 are:

1. The election mechanism of multicast switches on the shared network segment

Shared network segment is the situation of there is more than one multicast switch on a network segment. Under this kind of situation, since all switches which runs IGMP under this network segment can get membership report message from the host, therefore, only one switch is required to transmit membership query message, so an exchange election mechanism is required to determine a switch as query machine. In IGMP version1, the selection of query machine is determined by Multicast Routing Protocol; IGMP version2 made an improvement for it, it prescribed that when there are more than one multicast switches on the same network segment, the multicast switch with the lowest IP address will be elected as the query machine.

2. IGMP version2 added Leave Group Mechanism

In IGMP version 1, the host leaves the multicast group silently without sending any notification to any multicast switch. This causes that the multicast switch can only determine the leave of multicast member by multicast group response time-out. But in version2, when a host decides to leave a multicast group, if it is the host which gives response to the latest membership query message, then it will send out a message implying it is leaving.

3. IGMP version 2 added the query to specific group

In IGMP version1, a query of multicast switch is for all multicast groups on the network segment. This query is called general group query. In IGMP version2, query of specific group is added besides general group query. The destination IP address of this kind of query message is the

IP address of the multicast group, the group address field part of the message is also the IP address of the multicast group. Thus it is prevented that hosts which are other multicast group members transmit response message.

4. IGMP version2 added the biggest response time field

IGMP version2 added the biggest response time field to dynamically adjust the response time of the host to group query message.

The main features of version3 is allowing the host to choose receiving from or rejecting a certain source, which is the basis of SSM (Source-Specific Multicast) multicast. For example, when a host is sending a report of INCLUDE{10.1.1.1, 10.1.1.2} to some group G, that means the host needs the router to forward the flux from 10.1.1.1 and 10.1.1.2; when a host is sending a report of EXCLUDE{192.168.1.1} to some group G, that means the host needs the flux from all sources of group G except 192.168.1.1. This makes a great difference from the previous IGMP.

The main improvements of IGMP Version3 over IGMP Version1 and Version2 are:

1. The status to be maintained is group and source list, not only the groups in IGMPv2.
2. The interoperations with IGMPv1 and IGMPv2 are defined in IGMPv3 status.
3. IP service interface is modified to allow specific source list thereby.
4. The queried includes his/her Robustness Variable and Query Interval in query group to allow the synchronization with these variables of non-queries.
5. Max Response Time in Query Message has an exponential range, with maximum value from 25.5 secs of v2 to 53 mins, which can be used in links of great capacity.
6. In order to increase strength, the host retransmits State-Change message.
7. Additional data is defined to adapt future extension.
8. Report group is sent to 224.0.0.22 to help with IGMP Snooping of Layer 2 Switch.
9. Report group can include more than one group record, and it allows using small group to report complete current status.
10. The host does not restrain operation any more, which simplifies the implement and allows direct membership trace.
11. In querying messages, the new router side restraint process (S sign) modified the existing strength of IGMPv2.

6.9.2 IGMP Configuration Task List

1. Enable IGMP (Required)
2. Configure IGMP sub-parameters (Optional)
 - (1) Configure IGMP group parameters
 - 1) Configure IGMP group filtering conditions
 - 2) Configure IGMP to join in group
 - 3) Configure IGMP to join in static group
 - (2) Configure IGMP query parameters
 - 1) Configure the interval of IGMP sending query message

- 2) Configure the maximum response time of IGMP query
 - 3) Configure time-out of IGMP query
 - (3) Configure IGMP version
3. Disable IGMP Protocol

1. Enable IGMP Protocol

There are not specific commands for enabling IGMP Protocol on the Layer 3 switch. Enabling any multicast protocol under corresponding interface will automatically enable IGMP.

Command	Explanation
Global Mode	
ip dvmrp multicast-routing ip pim multicast-routing	To enable global multicast protocol is the prerequisite to enable IGMP protocol, the “ no ip dvmrp multicast-routing no ip pim multicast-routing ” commands disable multicast protocol and IGMP protocol. (Required)

Command	Explanation
Interface Configuration Mode	
ip dvmrp enable ip pim dense-mode ip pim sparse-mode	Enable IGMP Protocol, the corresponding commands “ no ip dvmrp enable no ip pim dense-mode no ip pim sparse-mode ” disable IGMP Protocol. (Required)

2. Configure IGMP Sub-parameters

(1) Configure IGMP group parameters

- 1) Configure IGMP group filtering conditions
- 2) Configure IGMP to join in group
- 3) Configure IGMP to join in static group

Command	Explanation
Interface Configuration Mode	
ip igmp access-group {<acl_num acl_name>} no ip igmp access-group	Configure the filtering conditions of the interface to IGMP group; the “ no ip igmp access-group ” command cancels the filtering condition.
ip igmp join-group <A.B.C.D > no ip igmp join-group <A.B.C.D >	Configure the interface to join in some IGMP group, the “ no ip igmp join-group <A.B.C.D > ” command cancels the join.
ip igmp static-group <A.B.C.D > no ip igmp static-group <A.B.C.D >	Configure the interface to join in some IGMP static group; the “ no ip igmp static-group <A.B.C.D > ” command cancels the join.

(2) Configure IGMP Query parameters

- 1) Configure interval for IGMP to send query messages
- 2) Configure the maximum response time of IGMP query

3) Configure the time-out of IGMP query

Command	Explanation
Interface Configuration Mode	
ip igmp query-interval <time_val> no ip igmp query-interval	Configure the interval of IGMP query messages sent periodically; the “ no ip igmp query-interval ” command restores default value.
ip igmp query-max-response-time <time_val> no ip igmp query-max-response-time	Configure the maximum response time of the interface for IGMP query; the “ no ip igmp query-max-response-time ” command restores default value.
ip igmp query-timeout <time_val> no ip igmp query-timeout	Configure the time-out of the interface for IGMP query; the “ no ip igmp query-timeout ” command restores default value.

(3) Config IGMP version

Command	Explanation
Global Mode	
ip igmp version <version> no ip igmp version	Configure IGMP version on the interface; the “ no ip igmp version ” command restores the default value.

3. Disable IGMP Protocol

Command	Explanation
Interface Configuration Mode	
no ip dvmrp no ip pim dense-mode no ip pim sparse-mode no ip dvmrp multicast-routing no ip pim multicast-routing	Disable IGMP Protocol.

6.9.3 IGMP Configuration Examples

As shown in the following figure, add the Ethernet ports of Switch A and Switch B to corresponding VLAN, and start PIM-DM on each VLAN interface.

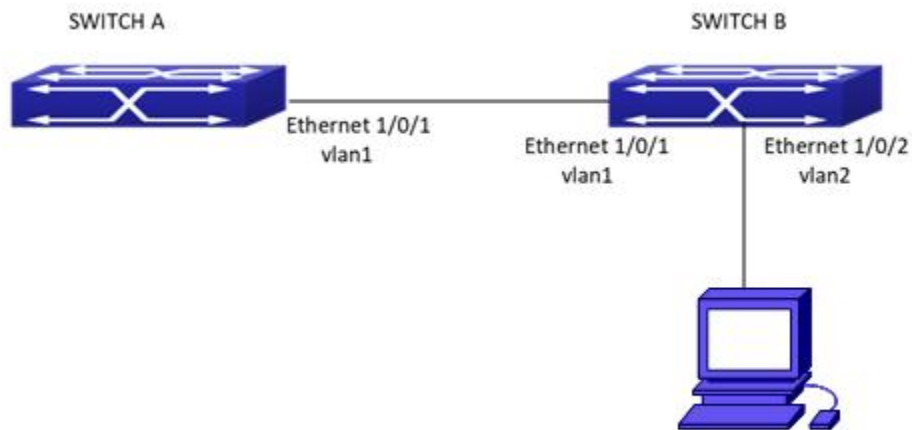

Figure 5- 10 IGMP Network Topology Diagram

The configuration procedure for SwitchA and SwitchB is as follows:

(1) Configure SwitchA:

```
Switch(config)#ip pim multicast-routing
Switch (config)#interface vlan 1
Switch(Config-if-Vlan1)#ip address 12.1.1.1 255.255.255.0
Switch(Config-if-Vlan1)#ip pim dense-mode
```

(2) Configure SwitchB:

```
Switch(config)#ip pim multicast-routing
Switch(config)#interface vlan1
Switch(Config-if-Vlan1)#ip address 12.1.1.2 255.255.255.0
Switch(Config-if-Vlan1)#ip pim dense-mode
Switch(Config-if-Vlan1)#exit
Switch(config)#interface vlan2
Switch(Config-if-Vlan1)#ip address 20.1.1.1 255.255.255.0
Switch(Config-if-Vlan2)#ip pim dense-mode
Switch(Config-if-Vlan2)#ip igmp version 3
```

6.9.4 IGMP Troubleshooting

In configuring and using IGMP Protocol, IGMP Protocol might not operate normally caused by physical connection or incorrect configuration. Therefore, user should pay attention to the following issues:

- ☞ Firstly to assure that physical connection is correct;
- ☞ Next, to assure the Protocol of Interface and Link protocol is UP (use show interface command);
- ☞ Afterwards, to assure to start a kind of multicast protocol on the interface;
- ☞ Multicast Protocol requires RPF Check using unicast routing; therefore the correctness of unicast routing must be assured beforehand.

6.10 IGMP Snooping

6.10.1 Introduction to IGMP Snooping

IGMP (Internet Group Management Protocol) is a protocol used in IP multicast. IGMP is used by multicast enabled network device (such as a router) for host membership query, and by hosts that are joining a multicast group to inform the router to accept packets of a certain multicast address. All those operations are done through IGMP message exchange. The router will use a multicast address (224.0.0.1) that can address to all hosts to send an IGMP host membership query message. If a host wants to join a multicast group, it will reply to the multicast address of that a multicast group with an IGMP host membership reports a message.

IGMP Snooping is also referred to as IGMP listening. The switch prevents multicast traffic from flooding through IGMP Snooping, multicast traffic is forwarded to ports associated to multicast devices only. The switch listens to the IGMP messages between the multicast router and hosts, and maintains multicast group forwarding table based on the listening result, and can then decide to forward multicast packets according to the forwarding table.

Switch provides IGMP Snooping and is able to send a query from the switch so that the user can use switch in IP multicast.

6.10.2 IGMP Snooping Configuration Task List

1. Enable IGMP Snooping
2. Configure IGMP Snooping

1. Enable IGMP Snooping

Command	Explanation
Global Mode	
ip igmp snooping no ip igmp snooping	Enables IGMP Snooping. The no operation disables IGMP Snooping function.

2. Configure IGMP Snooping

Command	Explanation
Global Mode	
ip igmp snooping vlan <vlan-id> no ip igmp snooping vlan <vlan-id>	Enables IGMP Snooping for specified VLAN. The no operation disables IGMP Snooping for specified VLAN.
ip igmp snooping proxy no ip igmp snooping proxy	Enable IGMP Snooping proxy function, the no command disables the function.

<pre>ip igmp snooping vlan <vlan-id> limit {group <g_limit> source <s_limit>} no ip igmp snooping vlan <vlan-id> limit</pre>	<p>Configure the max group count of vlan and the max source count of every group. The “no ip igmp snooping vlan <vlan-id> limit” command cancels this configuration.</p>
<pre>ip igmp snooping vlan <1-4094> interface (ethernet port-channel) IFNAME limit {group <1-65535> source <1-65535>} strategy (replace drop) no ip igmp snooping vlan <1-4094> interface (ethernet port-channel) IFNAME limit group source strategy</pre>	<p>Configure the number of groups which are allowed joining and the maximum of the source in each group under the IGMP Snooping port. Configure the strategy when it is up to the upper limit, including “replace” and “drop”. No command configures as “no limitation”.</p>
<pre>ip igmp snooping vlan <vlan-id> l2-general-querier no ip igmp snooping vlan <vlan-id> l2-general-querier</pre>	<p>Set this vlan to layer 2 general querier. It is recommended to configure a layer 2 general querier on a segment. The “no ip igmp snooping vlan <vlan-id> l2-general-querier” command cancels this configuration.</p>
<pre>ip igmp snooping vlan <vlan-id> l2-general-querier-version <version></pre>	<p>Configure the version number of a general query from a layer 2 general querier.</p>
<pre>ip igmp snooping vlan <vlan-id> l2-general-querier-source <source></pre>	<p>Configure the source address of a general query from a layer 2 general querier.</p>
<pre>ip igmp snooping vlan <vlan-id> mrouter-port interface <interface-name> no ip igmp snooping vlan <vlan-id> mrouter-port interface <interface-name></pre>	<p>Configure static mrouter port of vlan. The no form of the command cancels this configuration.</p>
<pre>ip igmp snooping vlan <vlan-id> mrouter-port learnpim no ip igmp snooping vlan <vlan-id> mrouter-port learnpim</pre>	<p>Enable the function that the specified VLAN learns mrouter-port (according to pim packets), the no command will disable the function.</p>
<pre>ip igmp snooping vlan <vlan-id> mrpt <value> no ip igmp snooping vlan <vlan-id> mrpt</pre>	<p>Configure this survive time of mrouter port. The “no ip igmp snooping vlan <vlan-id> mrpt” command restores the default value.</p>
<pre>ip igmp snooping vlan <vlan-id> query-interval <value> no ip igmp snooping vlan <vlan-id> query-interval</pre>	<p>Configure this query interval. The “no ip igmp snooping vlan <vlan-id> query-interval” command restores the default value.</p>

<pre>ip igmp snooping vlan <vlan-id> immediately-leave no ip igmp snooping vlan <vlan-id> immediately-leave</pre>	<p>Enable the IGMP fast leave function for the specified VLAN: the “no ip igmp snooping vlan <vlan-id> immediate-leave” command disables the IGMP fast leave function.</p>
<pre>ip igmp snooping vlan <vlan-id> query-mrsp <value> no ip igmp snooping vlan <vlan-id> query-mrsp</pre>	<p>Configure the maximum query response period. The “no ip igmp snooping vlan <vlan-id> query-mrsp” command restores to the default value.</p>
<pre>ip igmp snooping vlan <vlan-id> query-robustness <value> no ip igmp snooping vlan <vlan-id> query-robustness</pre>	<p>Configure the query robustness. The “no ip igmp snooping vlan <vlan-id> query-robustness” command restores to the default value.</p>
<pre>ip igmp snooping vlan <vlan-id> suppression-query-time <value> no ip igmp snooping vlan <vlan-id> suppression-query-time</pre>	<p>Configure the suppression query time. The “no ip igmp snooping vlan <vlan-id> suppression-query-time” command restores to the default value.</p>
<pre>ip igmp snooping vlan <vlan-id> static-group <A.B.C.D> [source <A.B.C.D>] interface [ethernet port-channel] <IFNAME> no ip igmp snooping vlan <vlan-id> static-group <A.B.C.D> [source <A.B.C.D>] interface [ethernet port-channel] <IFNAME></pre>	<p>Configure static-group on specified port of the VLAN. The no form of the command cancels this configuration.</p>
<pre>ip igmp snooping vlan <vlan-id> report source-address <A.B.C.D> no ip igmp snooping vlan <vlan-id> report source-address</pre>	<p>Configure forwarding IGMP packet source address, The no operation cancels the packet source address.</p>
<pre>ip igmp snooping vlan <vlan-id> specific-query-mrsp <value> no ip igmp snooping vlan <vlan-id> specific-query-mrspt</pre>	<p>Configure the maximum query response time of the specific group or source, the no command restores the default value.</p>
<pre>ip igmp snooping vlan <vlan-id> not-forward no ip igmp snooping vlan <vlan-id> not-forward</pre>	<p>Configure the vlan not to forward IGMP packets to the mrouter port. The no command restores the default value.</p>

6.10.3 IGMP Snooping Examples

Scenario 1: IGMP Snooping function

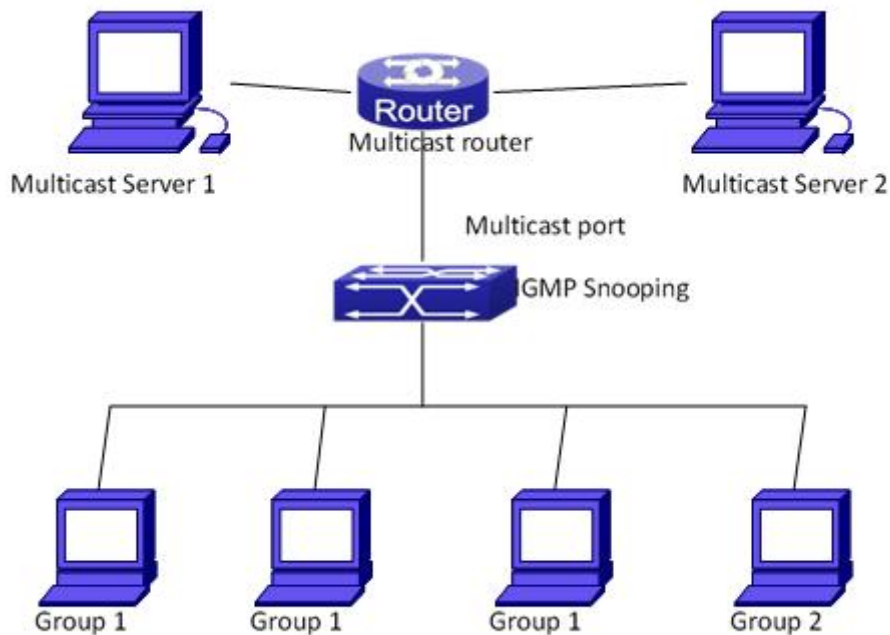

Figure 5- 11 Enabling IGMP Snooping function

Example: As shown in the above figure, a VLAN 100 is configured in the switch and includes ports 1, 2, 6, 10 and 12. Four hosts are connected to port 2, 6, 10 and 12 respectively and the multicast router is connected to port 1. As IGMP Snooping is disabled by default either in the switch or in the VLANs, If IGMP Snooping should be enabled in VLAN 100, the IGMP Snooping should be first enabled for the switch in Global Mode and in VLAN 100 and set port 1 of VLAN 100 to be the mrouter port.

The configuration steps are listed below:

```
Switch(config)#ip igmp snooping
Switch(config)#ip igmp snooping vlan 100
Switch(config)#ip igmp snooping vlan 100 mrouter interface ethernet 1/0/1
```

Multicast Configuration

Suppose two programs are provided in the Multicast Server using multicast address Group1 and Group2, three of four hosts running multicast applications are connected to port 2, 6, 10 plays program1, while the host is connected to port 12 plays program 2.

IGMP Snooping listening result:

The multicast table built by IGMP Snooping in VLAN 100 indicates ports 1, 2, 6, 10 in Group1 and ports 1, 12 in Group2.

All the four hosts can receive the program of their choice: ports 2, 6, 10 will not receive the traffic of program 2 and port 12 will not receive the traffic of program 1.

Scenario 2: L2-general-querier

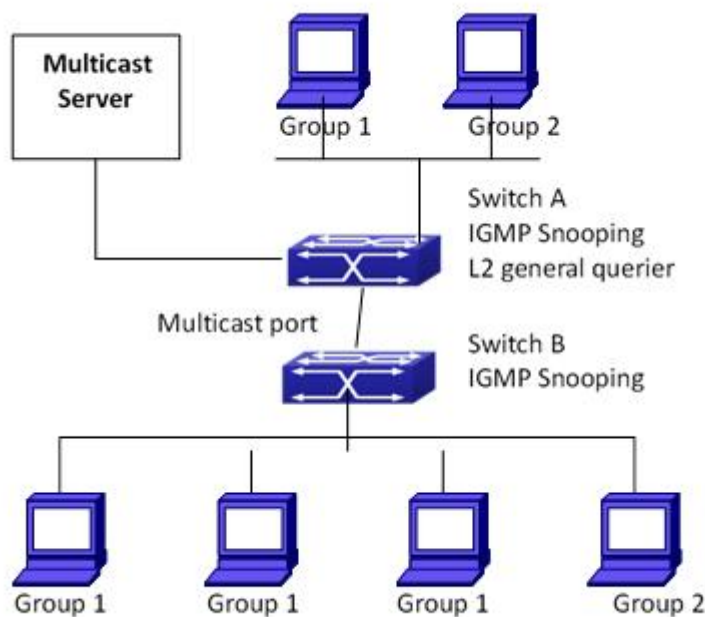

Figure 5- 12 The switches as IGMP Queries

The configuration of Switch2 is the same as the switch in scenario 1, SwitchA takes the place of Multicast Router in scenario 1. Let's assume VLAN 60 is configured in SwitchA, including ports 1, 2, 10 and 12. Port 1 connects to the multicast server, and port 2 connects to Switch2. In order to send Query at regular interval, IGMP query must enabled in Global mode and in VLAN60.

The configuration steps are listed below:

```
SwitchA#config
```

```
SwitchA(config)#ip igmp snooping
```

```
SwitchA(config)#ip igmp snooping vlan 60
```

```
SwitchA(config)#ip igmp snooping vlan 60 L2-general-querier
```

```
SwitchB#config
```

```
SwitchB(config)#ip igmp snooping
```

```
SwitchB(config)#ip igmp snooping vlan 100
```

```
SwitchB(config)#ip igmp snooping vlan 100 mrouter interface ethernet 1/0/1
```

Multicast Configuration

The same as scenario 1

IGMP Snooping listening result:

Similar to scenario 1

Scenario 3: To run in cooperation with layer 3 multicast protocols.

SWITCH which is used in Scenario 1 is replaced with ROUTER with specific configurations remains the same. And multicast and IGMP snooping configurations are the same with what it is in Scenario 1. To configure PIM-SM on ROUTER, and enable PIM-SM on vlan 100 (use the same PIM mode with the connected multicast router)

Configurations are listed as below:

```
switch#config
switch(config)#ip pim multicast-routing
switch(config)#interface vlan 100
switch(config-if-vlan100)#ip pim sparse-mode
```

IGMP snooping does not distribute entries when layer 3 multicast protocol is enabled. It only does the following tasks.

- 👉 Remove the layer 2 multicast entries.
- Provide query functions to the layer 3 with vlan, S, and G as the parameters.
- When layer 3 IGMP is disabled, re-enable distributing layer 2 multicast entries.

By looking up the layer 3 IPMC entries, it can be found that ports can be indicated by the layer 3 multicast entries. This ensures the IGMP snooping can work in cooperation with the layer 3 multicast protocols.

6.10.4 IGMP Snooping Troubleshooting

On IGMP Snooping function configuration and usage, IGMP Snooping might not run properly because of physical connection or configuration mistakes. So the users should note that:

- 👉 Make sure correct physical connection
- 👉 Activate IGMP Snooping on whole configuration mode (use **ip igmp snooping**)
- 👉 Configure IGMP Snooping at VLAN on whole configuration mode (use **ip igmp snooping vlan <vlan-id>**)
- 👉 Make sure one VLAN is configured as L2 common checker in same mask, or make sure configured static mrouter
- 👉 Use **show ip igmp snooping vlan <vid>** command check IGMP Snooping information

6.11 IGMP Proxy Configuration

6.11.1 Introduction to IGMP Proxy

IGMP/MLD proxy which is introduced in rfc4605, is a simplified multicast protocol running at edge boxes. The edge boxes which runs the IGMP/MLD proxy protocol, does not need to run complicated multicast routing protocols such as PIM/DVMRP. However they work with multicast protocol enabled network through IGMP/MLD proxy. They can simplify the implementation of multicasting on edge devices.

The IGMP/MLD proxy works between the multicast router and the client, it works as both the multicast host and router. Upstream and downstream ports should be specified in the

IGMP/MLD proxy configuration. The host protocol runs at upstream ports, while the router protocol runs at downstream ports. The switch collects the join and leave messages received from downstream ports and forward them to the multicast router through upstream ports.

The IGMP proxy configuration is exclusive with PIM and DVMRP configuration.

6.11.2 IGMP Proxy Configuration Task List

1. Enable IGMP Proxy function
2. Enable configurations for both downstream and upstream ports for the IGMP Proxy in different interfaces
3. Configure IGMP Proxy

1. Enable IGMP Proxy function

Command	Explanation
Global Mode	
ip igmp proxy no ip igmp proxy	Enable IGMP Proxy function. The “ no ip igmp proxy ” disables this function.

2. Enable configurations for both downstream and upstream ports for the IGMP Proxy in different interfaces

Command	Explanation
Interface Configuration Mode	
ip igmp proxy upstream no ip igmp proxy upstream	Enable IGMP Proxy upstream function. The “ no ip igmp proxy upstream ” disables this function.
ip igmp proxy downstream no ip igmp proxy downstream	Enable IGMP Proxy downstream function. The “ no ip igmp proxy downstream ” disables this function.

3. Configure IGMP Proxy assistant parameter

Command	Explanation
Global Mode	
ip igmp proxy limit {group <1-500> source <1-500>} no ip igmp proxy limit	To configure the maximum number of groups that upstream ports can join, and the maximum number of sources in a single group. The no form of this command will restore the default value.
ip igmp proxy unsolicited-report interval <1-5> no ip igmp proxy unsolicited-report interval	To configure how often the upstream ports send out unsolicited report. The no form of this command will restore the default configuration.
ip igmp proxy unsolicited-report robustness <2-10> no ip igmp proxy unsolicited-report robustness	To configure the retry times of upstream ports' sending unsolicited reports. The no form of this command will restore the default value.

ip igmp proxy aggregate no ip igmp proxy aggregate	To configure non-query downstream ports to be able to aggregate the IGMP operations. The no form of this command will restore the default configuration.
ip multicast ssm range <1-99> ip multicast ssm default no ip multicast ssm	To configure the address range for IGMP proxy ssm multicast groups; The no form of this command will remove the configuration.
ip igmp proxy multicast-source no ip igmp proxy multicast-source	To configure the port as downstream ports for the source of multicast datagram; The no form of this command will disable the configuration.

6.11.3 IGMP Proxy Examples

Example 1: IGMP Proxy function.

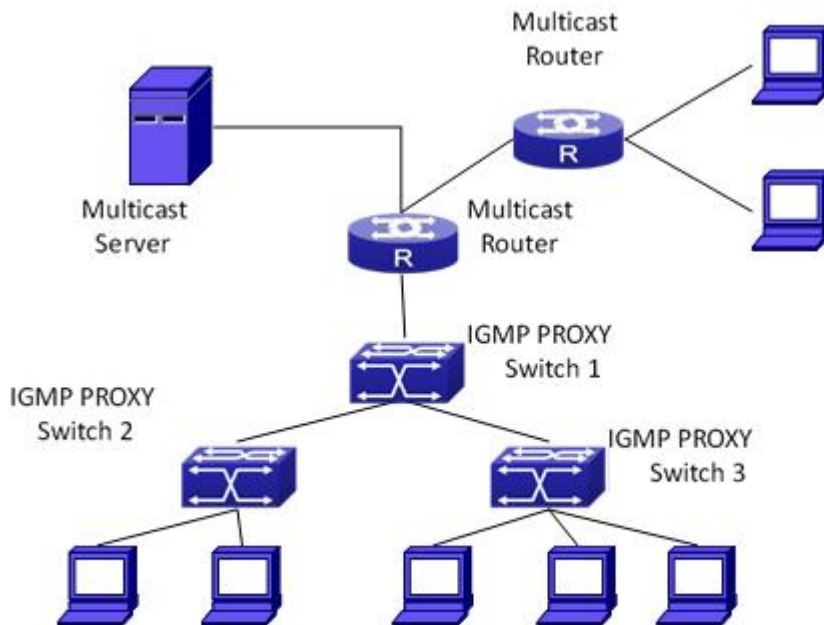

Figure 5- 13 IGMP Proxy Topology Diagram

As it is show in the figure above, the switch functions as IGMP Proxy in a network of topology of tree, the switch aggregates the multicast dataflow from upstream port and redistributes them to the downstream ports, while the IGMP membership reports flow from downstream ports to upstream ports. Three IGMP Proxy enabled switches which are connected in tree topology, respectively have one port connected to multicast routers, and no less than one ports connected to hosts or upstream ports from other IGMP Proxy enabled switches.

The configuration steps are listed below:

```

Switch#config
Switch(config)#ip igmp proxy
Switch(Config)#interface vlan 1
Switch(Config-if-Vlan1)#ip igmp proxy upstream
Switch(Config)#interface vlan 2
Switch(Config-if-Vlan2)#ip igmp proxy downstream

```

Multicast Configuration:

Suppose the multicast server offers some programs through 224.1.1.1. Some hosts subscribe that program at the edge of the network. The IGMP multicast members report themselves to the downstream ports of IGMP Proxy enabled Switch 2 and Switch 3. Switch 2 and Switch 3 then aggregate the group membership information and send them through the upstream ports. Switch 1 finally forward these membership information to the multicast router when receiving the group membership information through upstream ports, and deliver the multicast dataflow through downstream ports.

Example2: IGMP Proxy for multicast sources from downstream ports.

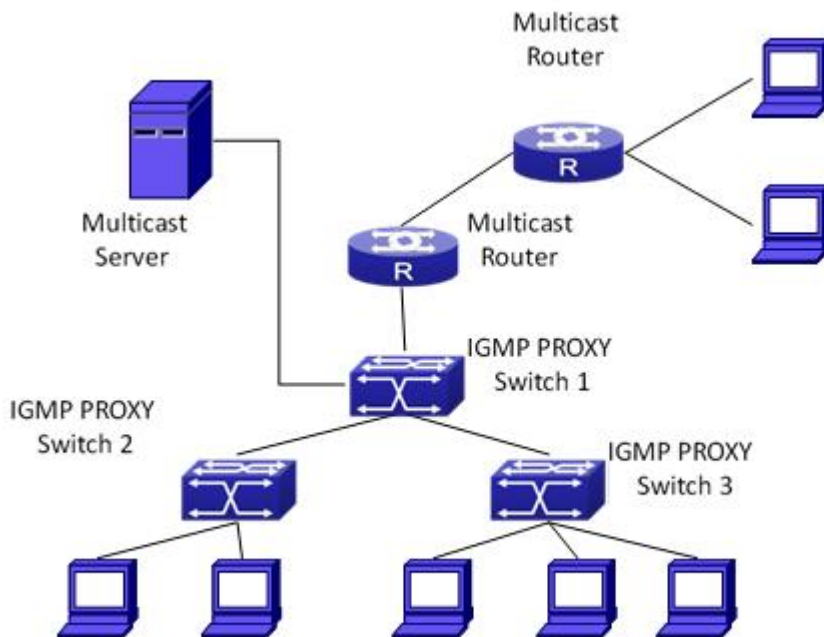

Figure 5- 14 IGMP Proxy for multicast sources from downstream ports

As it show in the figure above, IGMP Proxy enabled switches connected to the network in tree topology. The multicast source server connects to the downstream port of Switch1, the multicast dataflow is distributed through the upstream port and other downstream ports. Three IGMP Proxy enabled switches which are connected in tree topology, respectively have one port connected to multicast routers, and no less than one ports connected to hosts or upstream ports from other IGMP proxy enabled switches.

The configuration steps are listed below:

IGMP PROXY Switch1 configuration:

```
Switch#config
Switch(config)#ip igmp proxy
Switch(Config)#interface vlan 1
Switch(Config-if-Vlan1)#ip igmp proxy upstream
Switch(Config)#interface vlan 2
Switch(Config-if-Vlan2)#ip igmp proxy downstream
Switch(Config-if-Vlan2)#ip igmp proxy multicast-source
```

Route1 configuration:

```
Switch#config
Switch(config)#ip pim multicast
Switch(Config)#interface vlan 1
Switch(Config-if-Vlan1)#ip pim sparse-mode
Switch(Config-if-Vlan1)#ip pim bsr-border
```

Multicast Configuration:

Suppose the server provides programs through the multicast address 224.1.1.1, and some hosts subscribe that program on the edge of the network. The host reports their IGMP multicast group membership to Switch 2 and Switch 3 through downstream ports. Switch 2 and Switch 3 then aggregate and forward them to Switch 1 which then forwards the information to multicast router. When multicast dataflow arrives, the IGMP Proxy enabled switches re-distribute the group membership through upstream ports and downstream ports. When the multicast router receives the multicast dataflow from IGMP proxy, it will consider the multicast data source is directly connected to the router, and determine the identity of DR and ORIGINATOR. The multicast dataflow will be redistributed according to the PIM protocol.

6.11.4 IGMP Proxy Troubleshooting

When IGMP Proxy function configuration and usage, IGMP Proxy might not run properly because of physical connection or configuration mistakes. So the users should note that:

- ☞ Make sure physical connection correctly;
- ☞ Activate IGMP Proxy on whole Global mode (use **ip igmp proxy**);
- ☞ Make sure configure one upstream port and at least one downstream port under interface configuration mode (Use **ip igmp proxy upstream**, **ip igmp proxy downstream**);
- ☞ Use **show ip igmp proxy** command to check if the IGMP Proxy information is correct.

If the IGMP Proxy problem remains unsolved, please use debug IGMP Proxy and other debugging command and copy the DEBUG message within three minutes, send the recorded message to the technical service center of our company.

6.12 Multicast VLAN

6.12.1 Introductions to Multicast VLAN

Based on current multicast order method, when orders from users in different VLAN, each VLAN will copy a multicast traffic in this VLAN, which is a great waste of the bandwidth. By configuration of the multicast VLAN, we add the switch port to the multicast VLAN, with the IGMP Snooping/MLD Snooping functions enabled, users from different VLAN will share the same multicast VLAN. The multicast traffic only exists within a multicast VLAN, so the bandwidth is saved. As the multicast VLAN is absolutely separated from the user VLAN, security and bandwidth concerns can be met at the same time, after the multicast VLAN is configured, the multicast traffic will be continuously sent to the users.

6.12.2 Multicast VLAN Configuration Task List

1. Enable the multicast VLAN function
2. Configure the IGMP Snooping
3. Configure the MLD Snooping

1. Enable the multicast VLAN function

Command	Explanation
VLAN configuration mode	
multicast-vlan no multicast-vlan	Configure a VLAN and enable the multicast VLAN on it. The “ no multicast-vlan ” command disables the multicast function on the VLAN.
multicast-vlan association <vlan-list> no multicast-vlan association <vlan-list>	Associate a multicast VLAN with several VLANs. The no form of this command deletes the related VLANs associated with the multicast VLAN.
multicast-vlan association interface (ethernet port-channel) IFNAME no multicast-vlan association interface (ethernet port-channel) IFNAME	Associate the specified port with the multicast VLAN, so the associated ports are able to receive the multicast flow. The no command cancels the association between the ports and the multicast VLAN.
multicast-vlan mode {dynamic compatible} no multicast-vlan mode {dynamic compatible}	Configure the two modes of multicast vlan. The no command cancels the mode configuration.

2. Configure the IGMP Snooping

Command	Explanation
Global Mode	
ip igmp snooping vlan <vlan-id>	Enable the IGMP Snooping function on the

no ip igmp snooping vlan <vlan-id>	multicast VLAN. The no form of this command disables the IGMP Snooping on the multicast VLAN.
ip igmp snooping no ip igmp snooping	Enable the IGMP Snooping function. The no form of this command disables the IGMP snooping function.

3. Configure the MLD Snooping

ipv6 mld snooping vlan <vlan-id> no ipv6 mld snooping vlan <vlan-id>	Enable MLD Snooping on multicast VLAN; the no form of this command disables MLD Snooping on multicast VLAN.
ipv6 mld snooping no ipv6 mld snooping	Enable the MLD Snooping function. The no form of this command disables the MLD snooping function.

6.12.3 Multicast VLAN Examples

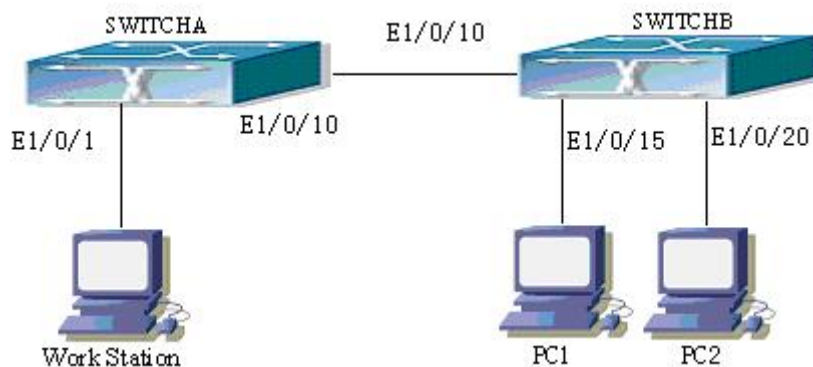

Figure 5- 15 Function configuration of the Multicast VLAN

As shown in the figure, the multicast server is connected to the layer 3 switch switchA through port 1/0/1 which belongs to the VLAN10 of the switch. The layer 3 switch switchA is connected with layer 2 switches through the port1/0/10, which configured as trunk port. On the switchB the VLAN100 is configured set to contain port1/0/15, and VLAN101 to contain port1/0/20. PC1 and PC2 are respectively connected to port 1/0/15 and1/0/20. The switchB is connected with the switchA through port1/0/10, which configured as trunk port. VLAN 20 is a multicast VLAN. By configuring multicast vlan, the PC1 and PC2 will receives the multicast data from the multicast VLAN.

Following configuration is based on the IP address of the switch has been configured and all the equipment are connected correctly.

Configuration procedure

```
SwitchA#config
SwitchA(config)#vlan 10
SwitchA(config-vlan10)#switchport access ethernet 1/0/1
SwitchA(config-vlan10)exit
```

```
SwitchA(config)#interface vlan 10
Switch(Config-if-Vlan10)#ip pim dense-mode
Switch(Config-if-Vlan10)#exit
SwitchA(config)#vlan 20
SwitchA(config-vlan20)#exit
SwitchA(config)#interface vlan 20
SwitchA(Config-if-Vlan20)#ip pim dense-mode
SwitchA(Config-if-Vlan20)#exit
SwitchA(config)#ip pim multicast
SwitchA(config)# interface ethernet1/0/10
SwitchA(Config-If-Ethernet1/0/10)switchport mode trunk
```

```
SwitchB#config
SwitchB(config)#vlan 100
SwitchB(config-vlan100)#Switchport access ethernet 1/0/15
SwitchB(config-vlan100)exit
SwitchB(config)#vlan 101
SwitchB(config-vlan101)#Switchport access ethernet 1/0/20
SwitchB(config-vlan101)exit
SwitchB(config)# interface ethernet 1/0/10
SwitchB(Config-If-Ethernet1/0/10)#switchport mode trunk
SwitchB(Config-If-Ethernet1/0/10)#exit
SwitchB(config)#vlan 20
SwitchB(config-vlan20)#multicast-vlan
SwitchB(config-vlan20)#multicast-vlan association 100,101
SwitchB(config-vlan20)#exit
SwitchB(config)#ip igmp snooping
SwitchB(config)#ip igmp snooping vlan 20
```

When multicast VLAN supports IPv6 multicast, usage is the same with IPv4, but the difference is using with MLD Snooping, so does not give an example.

Chapter 7 Security Function Configuration

7.1 ACL Configuration

7.1.1 Introduction to ACL

ACL (Access Control List) is an IP packet filtering mechanism employed in switches, providing network traffic control by granting or denying access the switches, effectively safeguarding the security of networks. The user can lay down a set of rules according to some information specific to packets, each rule describes the action for a packet with certain information matched: “permit” or “deny”. The user can apply such rules to the incoming direction of switch ports, so that data streams in the incoming direction of specified ports must comply with the ACL rules assigned.

7.1.1.1 Access-list

Access-list is a sequential collection of conditions that corresponds to a specific rule. Each rule consist of filter information and the action when the rule is matched. Information included in a rule is the effective combination of conditions such as source IP, destination IP, IP protocol number and TCP port, UDP port. Access-lists can be categorized by the following criteria:

- ✎ Filter information based criterion: IP access-list (layer 3 or higher information), MAC access-list (layer 2 information), and MAC-IP access-list (layer 2 or layer 3 or higher).
- ✎ Configuration complexity based criterion: standard and extended, the extended mode allows more specific filtering of information.
- ✎ Nomenclature based criterion: numbered and named.

Description of an ACL should cover the above three aspects.

7.1.1.2 Access-group

When a set of access-lists are created, they can be applied to traffic of incoming direction on all ports. Access-group is the description to the binding of an access-list to the incoming direction on a specific port. When an access-group is created, all packets from in the incoming direction through the port will be compared to the access-list rule to decide whether to permit or deny access.

The current firmware only supports ingress ACL configuration.

7.1.1.3 Access-list Action and Global Default Action

There are two access-list actions and default actions: “permit” or “deny”. The following rules apply:

- 👉 An access-list can consist of several rules. Filtering of packets compares packet conditions to the rules, from the first rule to the first matched rule; the rest of the rules will not be processed. Global default action applies only to IP packets in the incoming direction on the ports.
- 👉 Global default action applies only when packet filter is enabled on a port and no ACL is bound to that port, or no binding ACL matches.

7.1.2 ACL Configuration Task List

ACL Configuration Task Sequence:

1. Configuring access-list

- (1) Configuring a numbered standard IP access-list
- (2) Configuring a numbered extended IP access-list
- (3) Configuring a standard IP access-list based on nomenclature
 - a) Create a standard IP access-list based on nomenclature
 - b) Specify multiple “permit” or “deny” rule entries
 - c) Exit ACL Configuration Mode
- (4) Configuring an extended IP access-list based on nomenclature
 - a) Create an extensive IP access-list based on nomenclature
 - b) Specify multiple “permit” or “deny” rule entries
 - c) Exit ACL Configuration Mode
- (5) Configuring a numbered standard MAC access-list
- (6) Configuring a numbered extended MAC access-list
- (7) Configuring a extended MAC access-list based on nomenclature
 - a) Create a extensive MAC access-list based on nomenclature
 - b) Specify multiple “permit” or “deny” rule entries
 - c) Exit ACL Configuration Mode
- (8) Configuring a numbered extended MAC-IP access-list
- (9) Configuring a extended MAC-IP access-list based on nomenclature
 - a) Create a extensive MAC-IP access-list based on nomenclature
 - b) Specify multiple “permit” or “deny” rule entries
 - c) Exit MAC-IP Configuration Mode
- (10) Configuring a numbered standard IPv6 access-list
- (11) Configuring a numbered extended IPv6 access-list
- (12) Configuring a standard IPv6 access-list based on nomenclature
 - a) Create a standard IPv6 access-list based on nomenclature
 - b) Specify multiple permit or deny rule entries

- c) Exit ACL Configuration Mode
- (13) Configuring an extended IPv6 access-list based on nomenclature.
 - a) Create an extensive IPv6 access-list based on nomenclature
 - b) Specify multiple permit or deny rule entries
 - c) Exit ACL Configuration Mode
- 2. Configuring the packet filtering function
 - (1) Enable global packet filtering function
 - (2) Configure default action
- 3. Configuring time range function
 - (1) Create the name of the time range
 - (2) Configure periodic time range
 - (3) Configure absolute time range
- 4. Bind access-list to an incoming direction of the specified port
- 5. Clear the filtering information of the specified port

1. Configuring access-list

(1) Configuring a numbered standard IP access-list

Command	Explanation
Global Mode	
access-list <num> {deny permit} {{<slpAddr> <sMask>} any-source {host-source <slpAddr>}} no access-list <num>	Creates a numbered standard IP access-list, if the access-list already exists, then a rule will add to the current access-list; the “ no access-list <num> ” command deletes a numbered standard IP access-list.

(2) Configuring a numbered extensive IP access-list

Command	Explanation
Global Mode	
access-list <num> {deny permit} icmp {{<slpAddr> <sMask>} any-source {host-source <slpAddr>}} {{<dIpAddr> <dMask>} any-destination {host-destination <dIpAddr>}} [<icmp-type> [<icmp-code>]] [precedence <prec>] [tos <tos>][time-range<time-range-name>]	Creates a numbered ICMP extended IP access rule; if the numbered extended access-list of specified number does not exist, then an access-list will be created using this number.
access-list <num> {deny permit} igmp {{<slpAddr> <sMask>} any-source {host-source <slpAddr>}} {{<dIpAddr> <dMask>} any-destination {host-destination <dIpAddr>}} [<igmp-type>] [precedence <prec>] [tos <tos>][time-range<time-range-name>]	Creates a numbered IGMP extended IP access rule; if the numbered extended access-list of specified number does not exist, then an access-list will be created using this number.
access-list <num> {deny permit} tcp {{<slpAddr> <sMask>} any-source {host-source <slpAddr>}}	Creates a numbered TCP extended IP access rule; if the

[s-port {<sPort> range <sPortMin> <sPortMax>}] {{<dIpAddr> <dMask>} any-destination {host-destination <dIpAddr>}} [d-port {<dPort> range <dPortMin> <dPortMax>}] [ack+fin+psh+rst+urg+syn] [precedence <prec>] [tos <tos>][time-range<time-range-name>]	numbered extended access-list of specified number does not exist, then an access-list will be created using this number.
access-list <num> {deny permit} udp {{<sIpAddr> <sMask>} any-source {host-source <sIpAddr>}} [s-port {<sPort> range <sPortMin> <sPortMax>}] {{<dIpAddr> <dMask>} any-destination {host-destination <dIpAddr>}} [d-port {<dPort> range <dPortMin> <dPortMax>}] [precedence <prec>] [tos <tos>][time-range<time-range-name>]	Creates a numbered UDP extended IP access rule; if the numbered extended access-list of specified number does not exist, then an access-list will be created using this number.
access-list <num> {deny permit} {eigrp gre igmp ipinip ip ospf <protocol-num>} {{<sIpAddr> <sMask>} any-source {host-source <sIpAddr>}} {{<dIpAddr> <dMask>} any-destination {host-destination <dIpAddr>}} [precedence <prec>] [tos <tos>][time-range<time-range-name>]	Creates a numbered IP extended IP access rule for other specific IP protocol or all IP protocols; if the numbered extended access-list of specified number does not exist, then an access-list will be created using this number.
no access-list <num>	Deletes a numbered extensive IP access-list.

(3) Configuring a standard IP access-list basing on nomenclature

a. Create a name-based standard IP access-list

Command	Explanation
Global Mode	
ip access-list standard <name> no ip access-list standard <name>	Creates a standard IP access-list based on nomenclature; the “ no ip access-list standard <name> ” command deletes the name-based standard IP access-list.

b. Specify multiple “permit” or “deny” rules

Command	Explanation
Standard IP ACL Mode	
[no] {deny permit} {{<sIpAddr> <sMask>} any-source {host-source <sIpAddr>}}	Creates a standard name-based IP access rule; the “ no ” form command deletes the name-based standard IP access rule.

c. Exit name-based standard IP ACL configuration mode

Command	Explanation
Standard IP ACL Mode	

exit	Exits name-based standard IP ACL configuration mode.
-------------	--

(4) Configuring an name-based extended IP access-list**a. Create an extended IP access-list basing on nomenclature**

Command	Explanation
Global Mode	
ip access-list extended <name> no ip access-list extended <name>	Creates an extended IP access-list basing on nomenclature; the “ no ip access-list extended <name> ” command deletes the name-based extended IP access-list.

b. Specify multiple “permit” or “deny” rules

Command	Explanation
Extended IP ACL Mode	
[no] {deny permit} icmp {{<sIpAddr> <sMask>} any-source {host-source <sIpAddr>}} {{<dIpAddr> <dMask>} any-destination {host-destination <dIpAddr>}} [<icmp-type> [<icmp-code>]] [precedence <prec>] [tos <tos>][time-range<time-range-name>]	Creates an extended name-based ICMP IP access rule; the no form command deletes this name-based extended IP access rule.
[no] {deny permit} igmp {{<sIpAddr> <sMask>} any-source {host-source <sIpAddr>}} {{<dIpAddr> <dMask>} any-destination {host-destination <dIpAddr>}} [<igmp-type>] [precedence <prec>] [tos <tos>][time-range<time-range-name>]	Creates an extended name-based IGMP IP access rule; the no form command deletes this name-based extended IP access rule.
[no] {deny permit} tcp {{<sIpAddr> <sMask>} any-source {host-source <sIpAddr>}} [s-port {<sPort> range <sPortMin> <sPortMax>}] {{<dIpAddr> <dMask>} any-destination {host-destination <dIpAddr>}} [d-port {<dPort> range <dPortMin> <dPortMax>}] [ack+fin+psh+rst+urg+syn] [precedence <prec>] [tos <tos>][time-range<time-range-name>]	Creates an extended name-based TCP IP access rule; the no form command deletes this name-based extended IP access rule.
[no] {deny permit} udp {{<sIpAddr> <sMask>} any-source {host-source <sIpAddr>}} [s-port {<sPort> range <sPortMin> <sPortMax>}] {{<dIpAddr> <dMask>} any-destination {host-destination <dIpAddr>}} [d-port {<dPort> range <dPortMin> <dPortMax>}] [precedence <prec>] [tos <tos>][time-range<time-range-name>]	Creates an extended name-based UDP IP access rule; the no form command deletes this name-based extended IP access rule.
[no] {deny permit} {eigrp gre igrp ipinip ip ospf <protocol-num>} {{<sIpAddr> <sMask>} any-source {host-source <sIpAddr>}} {{<dIpAddr> <dMask>} any-destination {host-destination <dIpAddr>}}	Creates an extended name-based IP access rule for other IP protocols; the no form command deletes this

[precedence <prec>] <tos> [time-range<time-range-name>]	[tos	name-based extended IP access rule.
---	-------------	-------------------------------------

c. Exit extended IP ACL configuration mode

Command	Explanation
Extended IP ACL Mode	
exit	Exits extended name-based IP ACL configuration mode.

(5) Configuring a numbered standard MAC access-list

Command	Explanation
Global Mode	
access-list<num>{deny permit}{any-source-mac}{host-source-mac<host_smac>}{<smac><smac-mask>} no access-list <num>	Creates a numbered standard MAC access-list, if the access-list already exists, then a rule will add to the current access-list; the “ no access-list <num> ” command deletes a numbered standard MAC access-list.

(6) Creates a numbered MAC extended access-list

Command	Explanation
Global Mode	
access-list<num> {deny permit} {any-source-mac host-source-mac<host_smac>}{<smac><smac-mask>}{any-destination-mac host-destination-mac<host_dmac>}{<dmac><dmac-mask>}{untagged-eth2 tagged-eth2 untagged-802-3 tagged-802-3} [<offset1> <length1> <value1> [<offset2> <length2> <value2> [<offset3> <length3> <value3> [<offset4> <length4> <value4>]]]] no access-list <num>	Creates a numbered MAC extended access-list, if the access-list already exists, then a rule will add to the current access-list; the “ no access-list <num> ” command deletes a numbered MAC extended access-list.

(7) Configuring a extended MAC access-list based on nomenclature

a. Create an extensive MAC access-list based on nomenclature

Command	Explanation
Global Mode	
mac-access-list extended <name> no mac-access-list extended <name>	Creates an extended name-based MAC access rule for other IP protocols; the no form command deletes this name-based extended MAC access rule.

b. Specify multiple “permit” or “deny” rule entries

Command	Explanation
Extended name-based MAC access rule Mode	
<pre>[no]{deny permit}{any-source-mac}{host-source-mac<host_ ost_smac>}{<smac><smac-mask>}} {any-destination-mac}{host-destination-mac <host_dmac>} {<dmac> <dmac-mask>}} [cos <cos-val> [<cos-bitmask>] [vlanId <vid-value> [<vid-mask>]][ethertype<protocol>[<protocol-mask>]]]]</pre>	Creates an extended name-based MAC access rule matching MAC frame; the no form command deletes this name-based extended MAC access rule.
<pre>[no]{deny permit} {any-source-mac {host-source-mac<host_smac>}{<smac><smac-mask>}} } {any-destination-mac}{host-destination-mac<host_dmac >}{<dmac><dmac-mask>}} [ethertype <protocol> [<protocol-mask>]]</pre>	Creates an extended name-based MAC access rule matching untagged ethernet 2 frame; the no form command deletes this name-based extended MAC access rule.
<pre>[no]{deny permit} {any-source-mac {host-source-mac<host_smac>}{<sma c><smac-mask>}} {any-destination-mac {host-destination-mac<host_dmac>}{<dmac><dmac-m ask>}} [vlanid <vid-value> [<vid-mask>]][ethertype <protocol> [<protocol-mask>]]]</pre>	Creates an name-based extended MAC access rule matching 802.3 frame; the no form command deletes this name-based extended MAC access rule.
<pre>[no]{deny permit}{any-source-mac {host-source-mac<h ost_smac>}{<smac><smac-mask>}}{any-destination-ma c {host-destination-mac<host_dmac>}{<dmac><dmac- mask>}}[untagged-eth2 [ethertype <protocol> [protocol-mask]]]</pre>	Creates an name-based extended MAC access rule matching tagged ethernet 2 frame; the no form command deletes this name-based extended MAC access rule.
<pre>[no]{deny permit}{any-source-mac {host-source-mac<h ost_smac>}{<smac><smac-mask>}} {any-destination-mac {host-destination-mac <host_dmac>}{<dmac><dmac-mask>}} [untagged-802-3]</pre>	Creates an name-based extended MAC access rule matching tagged 802.3 frame; the no form command deletes
<pre>[no]{deny permit}{any-source-mac {host-source-mac<h ost_smac>}{<smac><smac-mask>}}{any-destination-ma c {host-destination-mac<host_dmac>}{<dmac><dmac- mask>}}[tagged-eth2 [cos <cos-val> [<cos-bitmask>]] [vlanId <vid-value> [<vid-mask>]] [ethertype<protocol> [<protocol-mask>]]]</pre>	Creates an name-based extended MAC access rule matching tagged 802.3 frame; the no form command deletes
<pre>[no]{deny permit}{any-source-mac {host-source-mac <host_smac>}{<smac><smac-mask>}} {any-destination-mac {host-destination-mac<host_dmac >}{<dmac><dmac-mask>}} [tagged-802-3 [cos</pre>	Creates an name-based extended MAC access rule matching tagged 802.3 frame; the no form command deletes

<code><cos-val> [<i><cos-bitmask></i>] [vlanId <i><vid-value></i> [<i><vid-mask></i>]]</code>	this name-based extended MAC access rule.
---	---

c. Exit ACL Configuration Mode

Command	Explanation
Extended name-based MAC access configure Mode	
exit	Quit the extended name-based MAC access configure mode.

(8) Configuring a numbered extended MAC-IP access-list

Command	Explanation
Global mode	
<code>access-list<num>{deny permit} {any-source-mac {host-source-mac <host_smac> {<smac> <smac-mask>}} {any-destination-mac {host-destination-mac <host_dmac>} {<dmac><dmac-mask>}} icmp {{<source> <source-wildcard>} any-source {host-source <source-host-ip>}} {{<destination> <destination-wildcard>} any-destination {host-destination <destination-host-ip>}} [<i><icmp-type></i>] [<i><icmp-code></i>] [precedence <precedence>] [tos <tos>] [time-range <time-range-name>]</code>	Creates a numbered mac-icmp extended mac-ip access rule; if the numbered extended access-list of specified number does not exist, then an access-list will be created using this number.
<code>access-list<num>{deny permit}{any-source-mac {host-source-mac<host_smac>}}{<smac><smac-mask>}} {any-destination-mac {host-destination-mac <host_dmac>}}{<dmac><dmac-mask>}}igmp {{<source><source-wildcard>} any-source {host-source<source-host-ip>}} {{<destination><destination-wildcard>} any-destination {host-destination<destination-host-ip>}} [<i><igmp-type></i>] [precedence <precedence>] [tos <tos>][time-range<time-range-name>]</code>	Creates a numbered mac-igmp extended mac-ip access rule; if the numbered extended access-list of specified number does not exist, then an access-list will be created using this number.
<code>access-list<num>{deny permit}{any-source-mac {host-source-mac<host_smac>}}{<smac><smac-mask>}} {any-destination-mac {host-destination-mac <host_dmac>}}{<dmac><dmac-mask>}}tcp {{<source><source-wildcard>} any-source {host-source<source-host-ip>}} [s-port {<port1> range <sPortMin> <sPortMax>}] {{<destination><destination-wildcard>} any-destination {host-destination <destination-host-ip>}} [d-port {<port3> range <dPortMin> <dPortMax>}] [ack+fin+psh+rst+urg+syn] [precedence <precedence>]</code>	Creates a numbered mac-ip extended mac-tcp access rule; if the numbered extended access-list of specified number does not exist, then an access-list will be created using this number.

<pre>[tos <tos>][time-range<time-range-name>] access-list<num>{deny permit}{any-source-mac {host-source-mac<host_smac>} {<smac><smac-mask>}} {any-destination-mac {host-destination-mac <host_dmac>} {<dmac><dmac-mask>}}udp {{<source><source-wildcard>} any-source {host-source<source-host-ip>}} [s-port {<port1> range <sPortMin> <sPortMax>}] {{<destination><destination-wildcard>} any-destination {host-destination<destination-host-ip>}} [d-port {<port3> range <dPortMin> <dPortMax>}] [precedence <precedence>] [tos <tos>][time-range<time-range-name>]</pre>	<p>Creates a numbered mac-udp extended mac-ip access rule; if the numbered extended access-list of specified number does not exist, then an access-list will be created using this number.</p>
<pre>access-list<num>{deny permit}{any-source-mac {host-source-mac<host_smac>} {<smac><smac-mask>}} {any-destination-mac {host-destination-mac <host_dmac>} {<dmac><dmac-mask>}} {eigrp gre igrp ip ipinip ospf {<protocol-num>}} {{<source><source-wildcard>} any-source {host-source<source-host-ip>}} {{<destination><destination-wildcard>} any-destination {host-destination<destination-host-ip>}} [precedence <precedence>] [tos <tos>][time-range<time-range-name>]</pre>	<p>Creates a numbered extended mac-ip access rule for other specific mac-ip protocol or all mac-ip protocols; if the numbered extended access-list of specified number does not exist, then an access-list will be created using this number.</p>
<pre>no access-list <num></pre>	<p>Deletes this numbered extended MAC-IP access rule.</p>

(9) Configuring a extended MAC-IP access-list based on nomenclature

a. Create an extensive MAC-IP access-list based on nomenclature

Command	Explanation
Global Mode	
<pre>mac-ip-access-list extended <name> no mac-ip-access-list extended <name></pre>	<p>Creates an extended name-based MAC-IP access rule; the no form command deletes this name-based extended MAC-IP access rule.</p>

b. Specify multiple “permit” or “deny” rule entries

Command	Explanation
Extended name-based MAC-IP access Mode	
<pre>[no]{deny permit} {any-source-mac {host-source-mac <host_smac>} {<smac><smac-mask>}} {any-destination-mac {host-destination-mac <host_dmac>} {<dmac><dmac-mask>}}icmp</pre>	<p>Creates an extended name-based MAC-ICMP access rule; the no form command deletes this</p>

<pre> {{<source><source-wildcard>} any-source {host-source<source-host-ip>}} {{<destination><destination-wildcard>} any-destination {host-destination <destination-host-ip>}} [<icmp-type> [<icmp-code>]] [precedence <precedence>][tos<tos>][time-range<time-range-name>] </pre>	<p>name-based extended MAC-ICMP access rule.</p>
<pre> [no]{deny permit}{any-source-mac{host-source-mac <host_smac>}{<smac><smac-mask>}} {any-destination-mac{host-destination-mac <host_dmac>}{<dmac><dmac-mask>}}igmp {{<source><source-wildcard>} any-source {host-source<source-host-ip>}} {{<destination><destination-wildcard>} any-destination {host-destination <destination-host-ip>}} [<igmp-type>] [precedence <precedence>] [tos <tos>][time-range<time-range-name>] </pre>	<p>Creates an extended name-based MAC-IGMP access rule; the no form command deletes this name-based extended MAC-IGMP access rule.</p>
<pre> [no]{deny permit}{any-source-mac{host-source-mac<h ost_smac>}{<smac><smac-mask>}} {any-destination-mac{host-destination-mac <host_dmac>}{<dmac><dmac-mask>}}tcp {{<source><source-wildcard>} any-source {host-source<source-host-ip>}} [s-port {<port1> range <sPortMin> <sPortMax>}] {{<destination><destination-wildcard>} any-destinatio n {host-destination <destination-host-ip>}} [d-port {<port3> range <dPortMin> <dPortMax>}] [ack+fin+psh+rst+urg+syn] [precedence<precedence>][tos<tos>][time-range<time-r ange-name>] </pre>	<p>Creates an extended name-based MAC-TCP access rule; the no form command deletes this name-based extended MAC-TCP access rule.</p>
<pre> [no]{deny permit}{any-source-mac{host-source-mac<h ost_smac>}{<smac><smac-mask>}} {any-destination-mac{host-destination-mac <host_dmac>}{<dmac><dmac-mask>}}udp {{<source><source-wildcard>} any-source {host-source<source-host-ip>}} [s-port {<port1> range <sPortMin> <sPortMax>}] {{<destination><destination-wildcard>} any-destination {host-destination <destination-host-ip>}} [d-port {<port3> range <dPortMin> <dPortMax>}] [precedence <precedence>] [tos <tos>][time-range<time-range-name>] </pre>	<p>Creates an extended name-based MAC-UDP access rule; the no form command deletes this name-based extended MAC-UDP access rule.</p>
<pre> [no]{deny permit}{any-source-mac{host-source-mac<h ost_smac>}{<smac><smac-mask>}} </pre>	<p>Creates an extended name-based access rule for the</p>

<pre>{any-destination-mac}{host-destination-mac <host_dmac>} {<dmac><dmac-mask>}} {eigrp gre igrp ip ipinip ospf {<protocol-num>}} {{<source><source-wildcard>} any-source {host-source<source-host-ip>}} {{<destination><destination-wildcard>} any-destination {host-destination<destination-host-ip>}} [precedence<precedence>][tos<tos>][time-range<time-r ange-name>]</pre>	<p>other IP protocol; the no form command deletes this name-based extended access rule.</p>
--	---

c. Exit MAC-IP Configuration Mode

Command	Explanation
Extended name-based MAC-IP access Mode	
exit	Quit extended name-based MAC-IP access mode.

(10) Configuring a numbered standard IPv6 access-list

Command	Explanation
Global Mode	
<pre>ipv6 access-list <num> {deny permit} {{<sIPv6Addr> <sPrefixlen>} any-source {host-source <sIPv6Addr>}} no ipv6 access-list <num></pre>	<p>Creates a numbered standard IPv6 access-list, if the access-list already exists, then a rule will add to the current access-list; the “no access-list <num>” command deletes a numbered standard IPv6 access-list.</p>

(11) Configuring a numbered extensive IPv6 access-list

Command	Explanation
Global Mode	
<pre>ipv6 access-list <num-ext> {deny permit} icmp {{<sIPv6Prefix/sPrefixlen>} any-source {host-source <sIPv6Addr>}} {<dIPv6Prefix/dPrefixlen> any-destination {host-destination <dIPv6Addr>}} [<icmp-type> [<icmp-code>]] [dscp <dscp>] [flow-label <fl>][time-range<time-range-name>] ipv6 access-list <num-ext> {deny permit} tcp {{<sIPv6Prefix/sPrefixlen>} any-source {host-source <sIPv6Addr>}} [s-port {<sPort> range <sPortMin> <sPortMax>}] {{<dIPv6Prefix/dPrefixlen> any-destination {host-destination <dIPv6Addr>}} [dPort {<dPort> range <dPortMin> <dPortMax>}] [syn ack urg rst fin psh] [dscp <dscp>] [flow-label</pre>	<p>Creates a numbered extended IPv6 access-list, if the access-list already exists, then a rule will add to the current access-list; the no command deletes a numbered standard IPv6 access-list.</p>

<pre> <flowlabel>][time-range<time-range-name>] ipv6 access-list <num-ext> {deny permit} udp {{<sIPv6Prefix/<sPrefixlen>} any-source {host-source <sIPv6Addr>}} [s-port {<sPort> range <sPortMin> <sPortMax>}] {{<dIPv6Prefix/<dPrefixlen>} any-destination {host-destination <dIPv6Addr>}} [dPort {<dPort> range <dPortMin> <dPortMax>}] [dscp <dscp>] [flow-label <flowlabel>][time-range<time-range-name>] ipv6 access-list <num-ext> {deny permit} <next-header> {<sIPv6Prefix/sPrefixlen> any-source {host-source <sIPv6Addr>}} {<dIPv6Prefix/dPrefixlen> any-destination {host-destination <dIPv6Addr>}} [dscp <dscp>] [flow-label <fl>][time-range<time-range-name>] no ipv6 access-list <num> </pre>	
--	--

(12) Configuring a standard IPv6 access-list based on nomenclature

a. Create a standard IPv6 access-list based on nomenclature

Command	Explanation
Global Mode	
<pre> ipv6 access-list standard <name> no ipv6 access-list standard <name> </pre>	Creates a standard IP access-list based on nomenclature; the no command delete the name-based standard IPv6 access-list.

b. Specify multiple permit or deny rules

Command	Explanation
Standard IPv6 ACL Mode	
<pre> [no] {deny permit} {{<sIPv6Prefix/sPrefixlen>} any-source {host-source <sIPv6Addr> } } </pre>	Creates a standard name-based IPv6 access rule; the no form command deletes the name-based standard IPv6 access rule.

c. Exit name-based standard IP ACL configuration mode

Command	Explanation
Standard IPv6 ACL Mode	
<pre> exit </pre>	Exits name-based standard IPv6 ACL configuration mode.

(13) Configuring an name-based extended IPv6 access-list

a. Create an extended IPv6 access-list basing on nomenclature

Command	Explanation
Global Mode	

ipv6 access-list extended <name> no ipv6 access-list extended <name>	Creates an extended IPv6 access-list basing on nomenclature; the no command deletes the name-based extended IPv6 access-list.
---	---

b. Specify multiple permit or deny rules

Command	Explanation
Extended IPv6 ACL Mode	
[no] {deny permit} icmp {{<sIPv6Prefix/sPrefixlen> any-source {host-source <sIPv6Addr>}} {<dIPv6Prefix/dPrefixlen> any-destination {host-destination <dIPv6Addr>}} [<icmp-type> [<icmp-code>]] [dscp <dscp>] [flow-label <flowlabel>] [time-range <time-range-name>]	Creates an extended name-based ICMP IPv6 access rule; the no form command deletes this name-based extended IPv6 access rule.
[no] {deny permit} tcp {<sIPv6Prefix/sPrefixlen> any-source {host-source <sIPv6Addr>}} [s-port {<sPort> range <sPortMin> <sPortMax>}] {<dIPv6Prefix/dPrefixlen> any-destination {host-destination <dIPv6Addr>}} [d-port {<dPort> range <dPortMin> <dPortMax>}] [syn ack urg rst fin psh] [dscp <dscp>] [flow-label <fl>] [time-range<time-range-name>]	Creates an extended name-based TCP IPv6 access rule; the no form command deletes this name-based extended IPv6 access rule.
[no] {deny permit} udp {<sIPv6Prefix/sPrefixlen> any-source {host-source <sIPv6Addr>}} [s-port {<sPort> range <sPortMin> <sPortMax>}] {<dIPv6Prefix/dPrefixlen> any-destination {host-destination <dIPv6Addr>}} [d-port {<dPort> range <dPortMin> <dPortMax>}] [dscp <dscp>] [flow-label <fl>] [time-range<time-range-name>]	Creates an extended name-based UDP IPv6 access rule; the no form command deletes this name-based extended IPv6 access rule.
[no] {deny permit} <proto> {<sIPv6Prefix/sPrefixlen> any-source {host-source <sIPv6Addr>}} {<dIPv6Prefix/dPrefixlen> 	Creates an extended name-based IPv6 access rule for other IPv6 protocols; the no form command deletes this name-based extended IPv6 access rule.

any-destination { host-destination <dIPv6Addr>}} [dscp <dscp>] [flow-label <flowlabel>] [time-range <time-range-name>]	
[no] {deny permit} {<sIPv6Prefix/sPrefixlen> any-source {host-source <sIPv6Addr>}} {<dIPv6Prefix/dPrefixlen> any-destination {host-destination <dIPv6Addr>}} [dscp <dscp>] [flow-label <flowlabel>] [time-range <time-range-name>]	Creates an extended name-based IPv6 access rule; the no form command deletes this name-based extended IPv6 access rule.

c. Exit extended IPv6 ACL configuration mode

Command	Explanation
Extended IPv6 ACL Mode	
exit	Exits extended name-based IPv6 ACL configuration mode.

2. Configuring packet filtering function

(1) Enable global packet filtering function

Command	Explanation
Global Mode	
firewall enable	Enables global packet filtering function.
firewall disable	Disables global packet filtering function.

3. Configuring time range function

(1) Create the name of the time range

Command	Explanation
Global Mode	
time-range <time_range_name>	Create a time range named time_range_name.
no time-range <time_range_name>	Stop the time range function named time_range_name.

(2) Configure periodic time range

Command	Explanation
Time range Mode	
absolute-periodic {Monday Tuesday Wednesday Thursday Friday Saturday Sunday} <start_time> to {Monday Tuesday Wednesday Thursday Friday Saturday Sunday} <end_time>	Configure the time range for the request of the week, and every week will run by the time range.

periodic {{Monday+Tuesday+Wednesday+Thursday+Friday+Saturday+Sunday} daily weekdays weekend } <start_time> to <end_time>	
[no] absolute-periodic {Monday Tuesday Wednesday Thursday Friday Saturday Sunday} <start_time> to {Monday Tuesday Wednesday Thursday Friday Saturday Sunday} <end_time>	Stop the function of the time range in the week.
[no] periodic {{Monday+Tuesday+Wednesday+Thursday+Friday+Saturday+Sunday} daily weekdays weekend } <start_time> to <end_time>	

(3) Configure absolute time range

Command	Explanation
Global Mode	
absolute start <start_time> <start_data> [end <end_time> <end_data>]	Configure absolute time range.
[no] absolute start <start_time> <start_data> [end <end_time> <end_data>]	Stop the function of the time range.

4. Bind access-list to a specific direction of the specified port.

Command	Explanation
Physical Port Mode/VLAN Interface Mode	
{ip ipv6 mac mac-ip} access-group <acl-name> {in out} [traffic-statistic] no {ip ipv6 mac mac-ip} access-group <acl-name> {in out}	Apply an access-list to the ingress or egress direction on the port; the no command deletes the access-list bound to the port.

5. Clear the filtering information of the specified port

Command	Explanation
Admin Mode	
clear access-group (in out) statistic interface { <interface-name> ethernet <interface-name> }	Clear the filtering information of the egress or ingress for the specified port.

7.1.3 ACL Example

Scenario 1:

The user has the following configuration requirement: port 10 of the switch connects to 10.0.0.0/24 segment, ftp is not desired for the user.

Configuration description:

1. Create a proper ACL
2. Configuring packet filtering function
3. Bind the ACL to the port

The configuration steps are listed below:

```
Switch(config)#access-list 110 deny tcp 10.0.0.0 0.0.0.255 any-destination d-port 21
```

```
Switch(config)#firewall enable
```

```
Switch(config)#interface ethernet 1/0/10
```

```
Switch(Config-If-Ethernet1/0/10)#ip access-group 110 in
```

```
Switch(Config-If-Ethernet1/0/10)#exit
```

```
Switch(config)#exit
```

Configuration result:

```
Switch#show firewall
```

```
Firewall status: enable.
```

```
Switch#show access-lists
```

```
access-list 110(used 1 time(s)) 1 rule(s)
```

```
access-list 110 deny tcp 10.0.0.0 0.0.0.255 any-destination d-port 21
```

```
Switch#show access-group interface ethernet 1/0/10
```

```
interface name:Ethernet1/0/10
```

```
the ingress acl use in firewall is 110, traffic-statistics Disable.
```

Scenario 2:

The configuration requirement is stated as below: The switch should drop all the 802.3 datagram with 00-12-11-23-xx-xx as the source MAC address coming from interface 10.

Configuration description:

1. Create the corresponding MAC ACL.
2. Configure datagram filtering.
3. Bind the ACL to the related interface.

The configuration steps are listed as below.

```
Switch(config)#access-list 1100 deny 00-12-11-23-00-00 00-00-00-00-ff-ff any-destination-mac untagged-802-3
```

```
Switch(config)#access-list 1100 deny 00-12-11-23-00-00 00-00-00-00-ff-ff any tagged-802
```

```
Switch(config)#firewall enable
```

```
Switch(config)#interface ethernet1/0/10
```

```
Switch(Config-If-Ethernet1/0/10)#mac access-group 1100 in
```

```
Switch(Config-If-Ethernet1/0/10)#exit
```

```
Switch(config)#exit
```

Configuration result:

```
Switch#show firewall
Firewall Status: Enable.
```

```
Switch #show access-lists
access-list 1100(used 1 time(s))
  access-list 1100 deny 00-12-11-23-00-00 00-00-00-00-ff-ff
any-destination-mac
  untagged-802-3
  access-list 1100 deny 00-12-11-23-00-00 00-00-00-00-ff-ff
any-destination-mac
Switch #show access-group interface ethernet 1/0/10
interface name:Ethernet1/0/10
  MAC Ingress access-list used is 1100,traffic-statistics Disable.
```

Scenario 3:

The configuration requirement is stated as below: The MAC address range of the network connected to the interface 10 of the switch is 00-12-11-23-xx-xx, and IP network is 10.0.0.0/24. FTP should be disabled and ping requests from outside network should be disabled.

Configuration description:

1. Create the corresponding access list.
2. Configure datagram filtering.
3. Bind the ACL to the related interface.

The configuration steps are listed as below.

```
Switch(config)#access-list 3110 deny 00-12-11-23-00-00 00-00-00-00-ff-ff any-destination-mac
tcp 10.0.0.0 0.0.0.255 any-destination d-port 21
Switch(config)#access-list 3110 deny any-source-mac 00-12-11-23-00-00 00-00-00-00-ff-ff icmp
any-source 10.0.0.0 0.0.0.255
```

```
Switch(config)#firewall enable
Switch(config)#interface ethernet 1/0/10
Switch(Config-If-Ethernet1/0/10)#mac-ip access-group 3110 in
Switch(Config-Ethernet1/0/10)#exit
Switch(config)#exit
```

Configuration result:

```
Switch#show firewall
Firewall Status: Enable.
```

```
Switch#show access-lists
  access-list 3110(used 1 time(s))
access-list 3110 deny 00-12-11-23-00-00 00-00-00-00-ff-ff
  any-destination-mac
```

```
tcp 10.0.0.0 0.0.0.255 any-destination d-port 21
    access-list 3110 deny any-source-mac 00-12-11-23-00-00 00-00-00-00-ff-ff icmp
any-source 10.0.0.0 0.0.0.255
```

```
Switch #show access-group interface ethernet 1/0/10
interface name:Ethernet1/0/10
    MAC-IP Ingress access-list used is 3110, traffic-statistics Disable.
```

Scenario 4:

The configuration requirement is stated as below: IPv6 protocol runs on the interface 600 of the switch. And the IPv6 network address is 2003:1:1:1::0/64. Users in the 2003:1:1:1:66::0/80 subnet should be disabled from accessing the outside network.

Configuration description:

1. Create the corresponding access list.
2. Configure datagram filtering.
3. Bind the ACL to the related interface.

The configuration steps are listed as below.

```
Switch(config)#ipv6 access-list 600 permit 2003:1:1:1:66::0/80 any-destination
Switch(config)#ipv6 access-list 600 deny 2003:1:1:1::0/64 any-destination
```

```
Switch(config)#firewall enable
Switch(config)#interface ethernet 1/0/10
Switch(Config-If-Ethernet1/0/10)#ipv6 access-group 600 in
Switch(Config-If-Ethernet1/0/10)#exit
Switch(config)#exit
```

Configuration result:

```
Switch#show firewall
    Firewall Status: Enable.
```

```
Switch#show ipv6 access-lists
IPv6 access-list 600(used 1 time(s))
    ipv6 access-list 600 deny 2003:1:1:1::0/64 any-source
    ipv6 access-list 600 permit 2003:1:1:1:66::0/80 any-source
```

```
Switch #show access-group interface ethernet 1/0/10
interface name:Ethernet1/0/10
    IPv6 Ingress access-list used is 600, traffic-statistics Disable.
```

Scenario 5:

The configuration requirement is stated as below: The interface 1, 2, 5, 7 belongs to vlan100, Hosts with 192.168.0.1 as its IP address should be disabled from accessing the listed interfaces.

Configuration description:

1. Create the corresponding access list.

2. Configure datagram filtering.
3. Bind the ACL to the related interface.

The configuration steps are listed as below.

```
Switch (config)#firewall enable
Switch (config)#vlan 100
Switch (Config-Vlan100)#switchport interface ethernet 1/0/1;2;5;7
Switch (Config-Vlan100)#exit
Switch (config)#access-list 1 deny host-source 192.168.0.1
Switch (config)#interface ethernet1/0/1;2;5;7
Switch (config-if-port-range)#ip access-group 1 in
Switch (Config-if-Vlan100)#exit
```

Configuration result:

```
Switch (config)#show access-group interface vlan 100
Interface VLAN 100:
Ethernet1/0/1:   IP Ingress access-list used is 1, traffic-statistics Disable.
Ethernet1/0/2:   IP Ingress access-list used is 1, traffic-statistics Disable.
Ethernet1/0/5:   IP Ingress access-list used is 1, traffic-statistics Disable.
Ethernet1/0/7:   IP Ingress access-list used is 1, traffic-statistics Disable.
```

7.1.4 ACL Troubleshooting

Checking for entries in the ACL is done in a top-down order and ends whenever an entry is matched.

- ☞ Each ingress port can bind one MAC-IP ACL, one IP ACL, one MAC ACL, one IPv6 ACL (via the physical interface mode or Vlan interface mode).
- ☞ When binding four ACL and packet matching several ACL at the same time, the priority relations are as follows in a top-down order. If the priority is same, then the priority of configuration at first is higher.
- ☞ Ingress IPv6 ACL
- ☞ Ingress MAC-IP ACL
- ☞ Ingress IP ACL
- ☞ Ingress MAC ACL
- ☞ The number of ACLs that can be successfully bound depends on the content of the ACL bound and the hardware resource limit. Users will be prompted if an ACL cannot be bound due to hardware resource limitation.
- ☞ If an access-list contains same filtering information but conflicting action rules, binding to the port will fail with an error message. For instance, configuring 'permit tcp any any-destination' and 'deny tcp any any-destination' at the same time is not permitted.
- ☞ Viruses such as 'worm.blaster' can be blocked by configuring ACL to block specific ICMP packets or specific TCP or UDP port packet

7.2 Self-defined ACL

7.2.1 Introduction to Self-defined ACL

ACL (Access Control Lists) is a packet filtering mechanism implemented by switch, providing network access control by granting or denying access the switches, effectively safeguarding the security of networks. The user can set a set of rules according to some information specific to packets, each rule describes the action for a packet with certain information matched: 'permit' or 'deny'. The user can apply such rules to the incoming direction of switch ports, so that data streams of specified ports must comply with the ACL rules assigned.

Self-defined ACL means that users can configure several self-defined windows as the matching field when users configure ACL. Self-defined windows do not specify which field definitely, but specify the offset in a packet and ignore the meaning of field. It matches the data at offset position which begins to fix the byte length according to the value and mask configuration.

7.2.1.1 Standard Self-defined ACL Template

Standard self-defined ACL can configure 16 windows. Each window can specify offset, its value from 0 to 31, unit is 2Bytes, namely, 0 means 0Bytes offset and 1 means 2Bytes offset. Besides, offset is according to the start offset position.

A standard self-defined ACL template should be configured for the offset configuration of every window before configuring the standard self-defined ACL list. This template is global and takes effect to all standard self-defined ACL list. Standard self-defined ACL template can configure the offset for 16 windows at most. The window which is not configured is not available, that means it cannot transmit configuration successfully if the standard self-defined ACL use this window. When a window in the template is configured, it cannot be modified if the standard self-defined ACL rule is configured with this window. But the standard self-defined ACL rule is not configured; the window can be reconfigured, modified or deleted. When uses it with other functions (such as AM, ARP-GUARP, anti-arpscan), please reduce using the window and keep them for 8 or less than it.

7.2.1.2 Digital Self-defined ACL

Digital self-defined ACL can configure multi-ACL lists and each of them can configure multi-rules. The number of the issued lists is according to the type of the card. One rule can configure value and mask for 16 windows at most. The length of every window is 2Bytes; the name range of the self-defined ACL list is <1200-1299>.

7.2.1.3 Named Self-defined ACL

Named self-defined ACL can configure multi-ACL lists and each of them can configure multi-rules. The number of the issued lists is according to the type of the card. One rule can configure value and mask for 16 windows at most. The length of every window is 2Bytes; the length of the name string is 1-64, and the string cannot include numbers only.

7.2.1.4 Self-defined ACL Configuration Transmitting

7.2.1.5 Special Explanation

7.2.2 Self-defined ACL Configuration

Task list of self-defined ACL configuration:

1. Configure the offset template
2. Configure the digital standard userdefined acl
3. Bind the userdefined acl rule to the port
4. Bind the userdefined acl rule to the vlan

1. Configure the offset template

Command	Explanation
Global Mode	
userdefined-access-list standard offset [window1 <offset>] [window2 <offset>] [window3 <offset>] [window4 <offset>] no userdefined-access-list standard offset [window1] [window2] [window3] [window4]	Create a standard custom access list template, and modify the window corresponding to the template if it already exists; The 'no' operation of this command is to delete the window corresponding to the standard custom access list template. If no window is specified, the entire standard custom access list template will be deleted.

2. Configure the digital standard userdefined acl

Command	Explanation
Global Mode	
userdefined-access-list standard <num> {deny permit} [packet-type ipv4 ipv6 l2-eth2 l2-llc l2-snap mpls] [window1 <value> <mask>] [/window2 <value> <mask>] [window3 <value> <mask>]	Create a custom numeric access list, and if it already exists, add a rule table entry; The 'no' operation of this command is to delete a custom access list.

<code>[window4 <value> <mask>] no userdefined-access-list <num></code>	
--	--

3. Bind the userdefined acl rule to the port

Command	Explanation
Port Mode	
<code>[no] userdefined access-group <num> in [traffic-statistic]</code>	Apply a user-defined access list in the entry direction of the specified port, and the no operation of this command is to delete the user-defined access list bound to the port.

4. Bind the userdefined acl rule to the vlan

Command	Explanation
Global Mode	
<code>[no] vael ip access-group <num> in [traffic-statistic/ vlan <vlan-id></code>	Apply userdefined-access-list to one direction of the VLAN. Decide whether the statistical counter should be added to the ACL according to the options. The no command deletes the configuration bound to the port.

7.2.3 Self-defined ACL Example

Scenario 1:

The user has the following configuration requirement: The packet whose first and second byte is 0x0003 is not allowed forwarding on port 1 of the switch.

Configuration description:

Create a self-defined ACL template according to condition

1. Create a corresponding self-defined ACL
2. Bind the self-defined ACL to the port
3. The configuration steps are listed **below**:
4. Switch(config)#userdefined-access-list standard offset window1 0
5. Switch(config)#userdefined-access-list standard 1200 deny window1 0003 FFFF

Switch(config)#

Switch(config)#firewall enable

Switch(config)#interface ethernet 1/0/1

Switch(config-if-ethernet1/0/1)#userdefined access-group 1200 in

Switch(config)#exit

Configuration **result**:

Switch #show **access-lists**

```
userdefined-access-list standard 1200(used 1 time(s)) 1 rule(s)
```

```
rule ID 1: deny window1 0003 ffff
```

```
Switch#show access-group interface ethernet 1/0/1
```

```
interface name:Ethernet1/0/1
```

Userdefined Ingress access-list used is 1200, traffic-statistics Disable.

7.2.4 Self-defined ACL Troubleshooting

- 👉 The troubleshooting of self-defined ACL can be dealt with according to the ordinary ACL. If the operation is wrong, the system will show the detailed error information.

7.3 802.1x

7.3.1 Introduction to 802.1x

The 802.1x protocol originates from 802.11 protocol, the wireless LAN protocol of IEEE, which is designed to provide a solution to doing authentication when users access a wireless LAN. The LAN defined in IEEE 802 LAN protocol does not provide access authentication, which means as long as the users can access a LAN controlling device (such as a LAN Switch), they will be able to get all the devices or resources in the LAN. There was no looming danger in the environment of LAN in those primary enterprise networks.

However, along with the boom of applications like mobile office and service operating networks, the service providers should control and configure the access from user. The prevailing application of WLAN and LAN access in telecommunication networks, in particular, make it necessary to control ports in order to implement the user-level access control. And as a result, IEEE LAN/WAN committee defined a standard, which is 802.1x, to do Port-Based Network Access Control. This standard has been widely used in wireless LAN and ethernet.

“Port-Based Network Access Control” means to authenticate and control the user devices on the level of ports of LAN access devices. Only when the user devices connected to the ports pass the authentication, can they access the resources in the LAN, otherwise, the resources in the LAN won't be available.

7.3.1.1 The Authentication Structure of 802.1x

The system using 802.1x has a typical Client/Server structure, which contains three entities (as illustrated in the next figure): Supplicant system, Authenticator system, and Authentication server system.

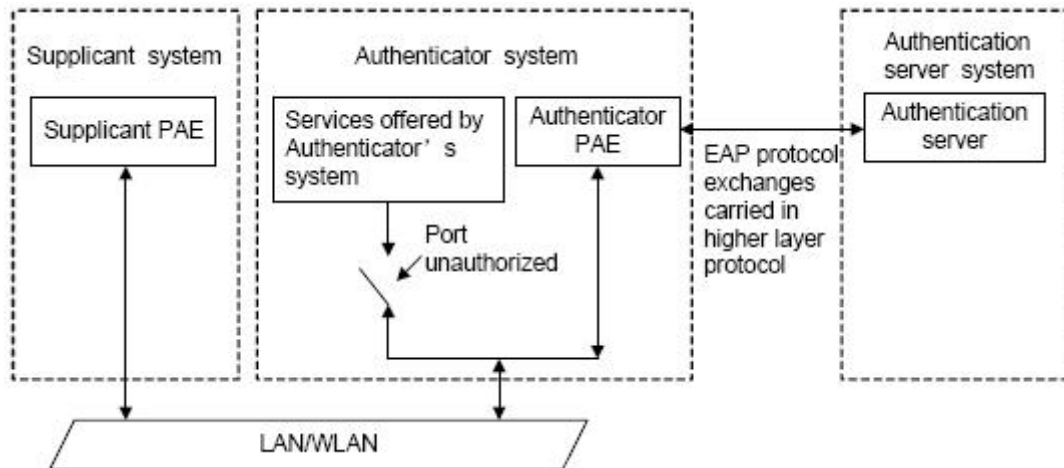

Figure 6- 1 The Authentication Structure of 802.1x

- ✎ The supplicant system is an entity on one end of the LAN segment, should be authenticated by the access controlling unit on the other end of the link. A Supplicant system usually is a user terminal device. Users start 802.1x authentication by starting supplicant system software. A supplicant system should support EAPOL (Extensible Authentication Protocol over LAN).
- ✎ The authenticator system is another entity on one end of the LAN segment to authenticate the supplicant systems connected. An authenticator system usually is a network device supporting 802,1x protocol, providing ports to access the LAN for supplicant systems. The ports provided can either be physical or logical.
- ✎ The authentication server system is an entity to provide authentication service for authenticator systems. The authentication server system is used to authenticate and authorize users, as well as does fee-counting, and usually is a RADIUS (Remote Authentication Dial-In User Service) server, which can store the relative user information, including username, password and other parameters such as the VLAN and ports which the user belongs to.

The three entities above concerns the following basic concepts: PAE of the port, the controlled ports and the controlled direction.

1. PAE

PAE (Port Access Entity) is the entity to implement the operation of algorithms and protocols.

- ✎ The PAE of the supplicant system is supposed to respond the authentication request from the authenticator systems and submit user's authentication information to the authenticator system. It can also send authentication request and off-line request to authenticator.
- ✎ The PAE of the authenticator system authenticates the supplicant systems needing to access the LAN via the authentication server system, and deal with the authenticated/unauthenticated state of the controlled port according to the result of the

authentication. The authenticated state means the user is allowed to access the network resources, the unauthenticated state means only the EAPOL messages are allowed to be received and sent while the user is forbidden to access network resources.

2. controlled/uncontrolled ports

The authenticator system provides ports to access the LAN for the supplicant systems. These ports can be divided into two kinds of logical ports: controlled ports and uncontrolled ports.

- ✎ The uncontrolled port is always in bi-directionally connected status, and mainly used to transmit EAPOL protocol frames, to guarantee that the supplicant systems can always send or receive authentication messages.
- ✎ The controlled port is in connected status authenticated to transmit service messages. When unauthenticated, no message from supplicant systems is allowed to be received.
- ✎ The controlled and uncontrolled ports are two parts of one port, which means each frame reaching this port is visible on both the controlled and uncontrolled ports.

3. Controlled direction

In unauthenticated status, controlled ports can be set as unidirectional controlled or bi-directionally controlled.

- ✎ When the port is bi-directionally controlled, the sending and receiving of all frames is forbidden.
- ✎ When the port is unidirectional controlled, no frames can be received from the supplicant systems while sending frames to the supplicant systems is allowed.

Notes: At present, this kind of switch only supports unidirectional control.

7.3.1.2 The Work Mechanism of 802.1x

IEEE 802.1x authentication system uses EAP (Extensible Authentication Protocol) to implement exchange of authentication information between the supplicant system, authenticator system and authentication server system.

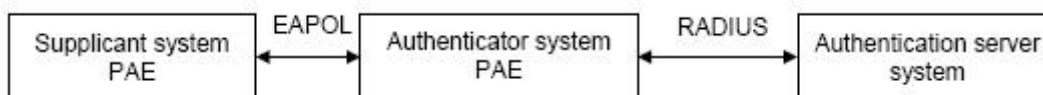

Figure 6-2 the Work Mechanism of 802.1x

- ✎ EAP messages adopt EAPOL encapsulation format between the PAE of the supplicant system and the PAE of the authenticator system in the environment of LAN.
- ✎ Between the PAE of the authenticator system and the RADIUS server, there are two methods to exchange information: one method is that EAP messages adopt EAPOR (EAP over RADIUS) encapsulation format in RADIUS protocol; the other is that EAP messages terminate with the PAE of the authenticator system, and adopt the messages containing RAP (Password Authentication Protocol) or CHAP (Challenge Handshake Authentication Protocol)

attributes to do the authentication interaction with the RADIUS server.

- ✎ When the user pass the authentication, the authentication server system will send the relative information of the user to authenticator system, the PAE of the authenticator system will decide the authenticated/unauthenticated status of the controlled port according to the authentication result of the RADIUS server.

7.3.1.3 The Encapsulation of EAPOL Messages

1. The Format of EAPOL Data Packets

EAPOL is a kind of message encapsulation format defined in 802.1x protocol, and is mainly used to transmit EAP messages between the supplicant system and the authenticator system in order to allow the transmission of EAP messages through the LAN. In IEEE 802/Ethernet LAN environment, the format of EAPOL packet is illustrated in the next figure. The beginning of the EAPOL packet is the Type/Length domain in MAC frames.

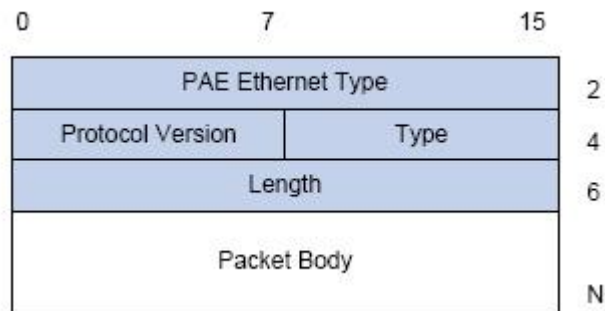

Figure 6- 3 the Format of EAPOL Data Packet

PAE Ethernet Type: Represents the type of the protocol whose value is 0x888E.

Protocol Version: Represents the version of the protocol supported by the sender of EAPOL data packets.

Type: represents the type of the EAPOL data packets, including:

- ✎ EAP-Packet (whose value is 0x00): the authentication information frame, used to carry EAP messages. This kind of frame can pass through the authenticator system to transmit EAP messages between the supplicant system and the authentication server system.
- ✎ EAPOL-Start (whose value is 0x01): the frame to start authentication.
- ✎ EAPOL-Logoff (whose value is 0x02): the frame requesting to quit.
- ✎ EAPOL-Key (whose value is 0x03): the key information frame.
- ✎ EAPOL-Encapsulated-ASF-Alert (whose value is 0x04): used to support the Alerting messages of ASF (Alert Standard Forum). This kind of frame is used to encapsulate the relative information of network management such as all kinds of alerting information, terminated by terminal devices.

Length: represents the length of the data, that is, the length of the “Packet Body”, in byte. There will be no following data domain when its value is 0.

Packet Body: represents the content of the data, which will be in different formats according to different types.

2. The Format of EAP Data Packets

When the value of Type domain in EAPOL packet is EAP-Packet, the Packet Body is in EAP format (illustrated in the next figure).

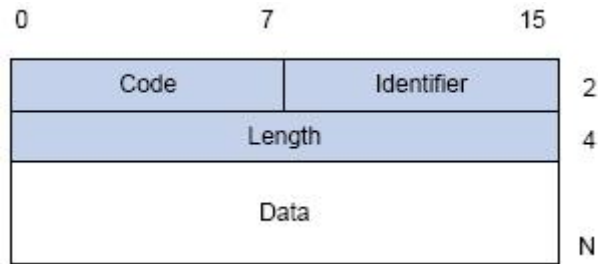

Figure 6-4 the Format of EAP Data Packets

Code: specifies the type of the EAP packet. There are four of them in total: Request (1), Response (2), Success (3), Failure (4).

- ☞ There is no Data domain in the packets of which the type is Success or Failure, and the value of the Length domains in such packets is 4.
- ☞ The format of Data domains in the packets of which the type is Request and Response is illustrated in the next figure. Type is the authentication type of EAP, the content of Type data depends on the type. For example, when the value of the type is 1, it means Identity, and is used to query the identity of the other side. When the type is 4, it means MD5-Challenge, like PPP CHAP protocol, contains query messages.

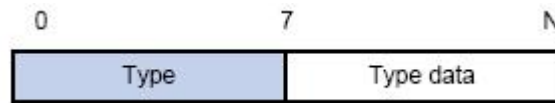

Figure 6-5 the Format of Data Domain in Request and Response Packets

Identifier: to assist matching the Request and Response messages.

Length: the length of the EAP packet, covering the domains of Code, Identifier, Length and Data, in byte.

Data: the content of the EAP packet, depending on the Code type.

7.3.1.4 The Encapsulation of EAP Attributes

RADIUS adds two attribute to support EAP authentication: EAP-Message and Message-Authenticator. Please refer to the Introduction of RADIUS protocol in “AAA-RADIUS-HWTACACS operation” to check the format of RADIUS messages.

1. EAP-Message

As illustrated in the next figure, this attribute is used to encapsulate EAP packet, the type code is 79, String domain should be no longer than 253 bytes. If the data length in an EAP packet is larger than 253 bytes, the packet can be divided into fragments, which then will be encapsulated in several EAP-Message attributes in their original order.

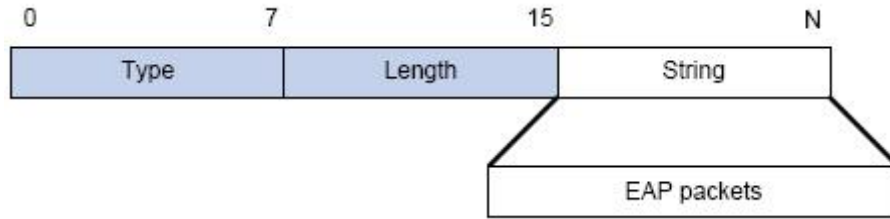

Figure 6-6 the Encapsulation of EAP-Message Attribute

2. Message-Authenticator

As illustrated in the next figure, this attribute is used in the process of using authentication methods like EAP and CHAP to prevent the access request packets from being eavesdropped. Message-Authenticator should be included in the packets containing the EAP-Message attribute, or the packet will be dropped as an invalid one.



Figure 6-7 Message-Authenticator Attribute

7.3.1.5 The Authentication Methods of 802.1x

The authentication can either be started by supplicant system initiatively or by devices. When the device detects unauthenticated users to access the network, it will send supplicant system EAP-Request/Identity messages to start authentication. On the other hand, the supplicant system can send EAPOL-Start message to the device via supplicant software.

802.1 x systems supports EAP relay method and EAP termination method to implement authentication with the remote RADIUS server. The following is the description of the process of these two authentication methods, both started by the supplicant system.

7.3.1.5.1 EAP Relay Mode

EAP relay is specified in IEEE 802.1x standard to carry EAP in other high-level protocols, such as EAP over RADIUS, making sure that extended authentication protocol messages can reach the authentication server through complicated networks. In general, EAP relay requires the RADIUS server to support EAP attributes: EAP-Message and Message-Authenticator.

EAP is a widely-used authentication frame to transmit the actual authentication protocol rather than a special authentication mechanism. EAP provides some common function and allows the authentication mechanisms expected in the negotiation, which are called EAP Method. The advantage of EAP lies in that EAP mechanism working as a base needs no adjustment when a new authentication protocol appears. The following figure illustrates the protocol stack of EAP authentication method.

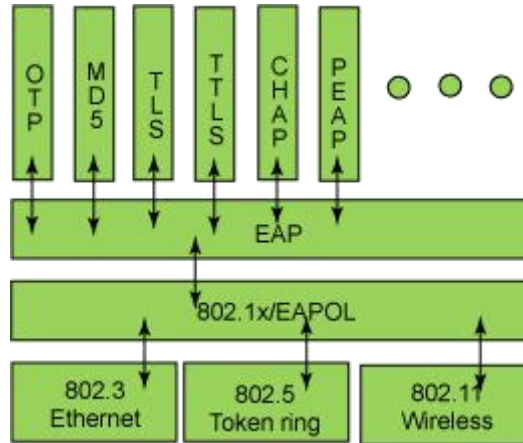

Figure 6-8 the Protocol Stack of EAP Authentication Method

By now, there are more than 50 EAP authentication methods has been developed, the differences among which are those in the authentication mechanism and the management of keys. The 4 most common EAP authentication methods are listed as follows:

- ✎ **EAP-MD5**
- ✎ **EAP-TLS** (Transport Layer Security)
- ✎ **EAP-TTLS** (Tunneled Transport Layer Security)
- ✎ **PEAP** (Protected Extensible Authentication Protocol)

They will be described in detail in the following part.

Attention:

- ✎ The switch, as the access controlling unit of Pass-through, will not check the content of a particular EAP method, so can support all the EAP methods above and all the EAP authentication methods that may be extended in the future.
- ✎ In EAP relay, if any authentication method in EAP-MD5, EAP-TLS, EAP-TTLS and PEAP is adopted, the authentication methods of the supplicant system and the RADIUS server should be the same.

1. EAP-MD5 Authentication Method

EAP-MD5 is an IETF open standard which providing the least security, since MD5 Hash function is vulnerable to dictionary attacks.

The following figure illustrated the basic operation flow of the EAP-MD5 authentication method.

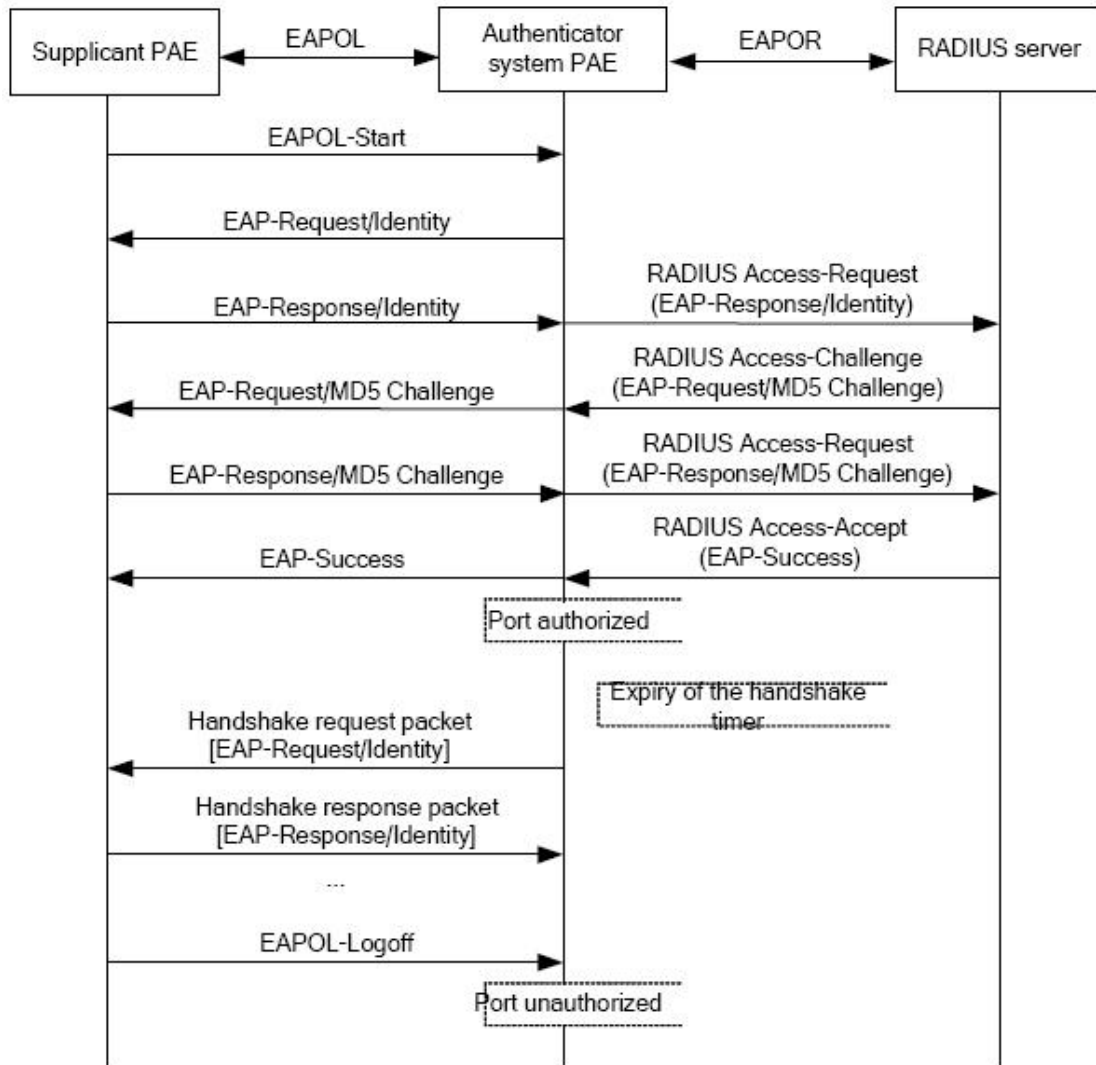

Figure 6-9 the Authentication Flow of 802.1x EAP-MD5

2. EAP-TLS Authentication Method

EAP-TLS is brought up by Microsoft based on EAP and TLS protocols. It uses PKI to protect the id authentication between the supplicant system and the RADIUS server and the dynamically generated session keys, requiring both the supplicant system and the Radius authentication server to possess digital certificate to implement bidirectional authentication. It is the earliest EAP authentication method used in wireless LAN. Since every user should have a digital certificate, this method is rarely used practically considering the difficult maintenance. However it is still one of the safest EAP standards, and enjoys prevailing supports from the vendors of wireless LAN hardware and software.

The following figure illustrates the basic operation flow of the EAP-TLS authentication method.

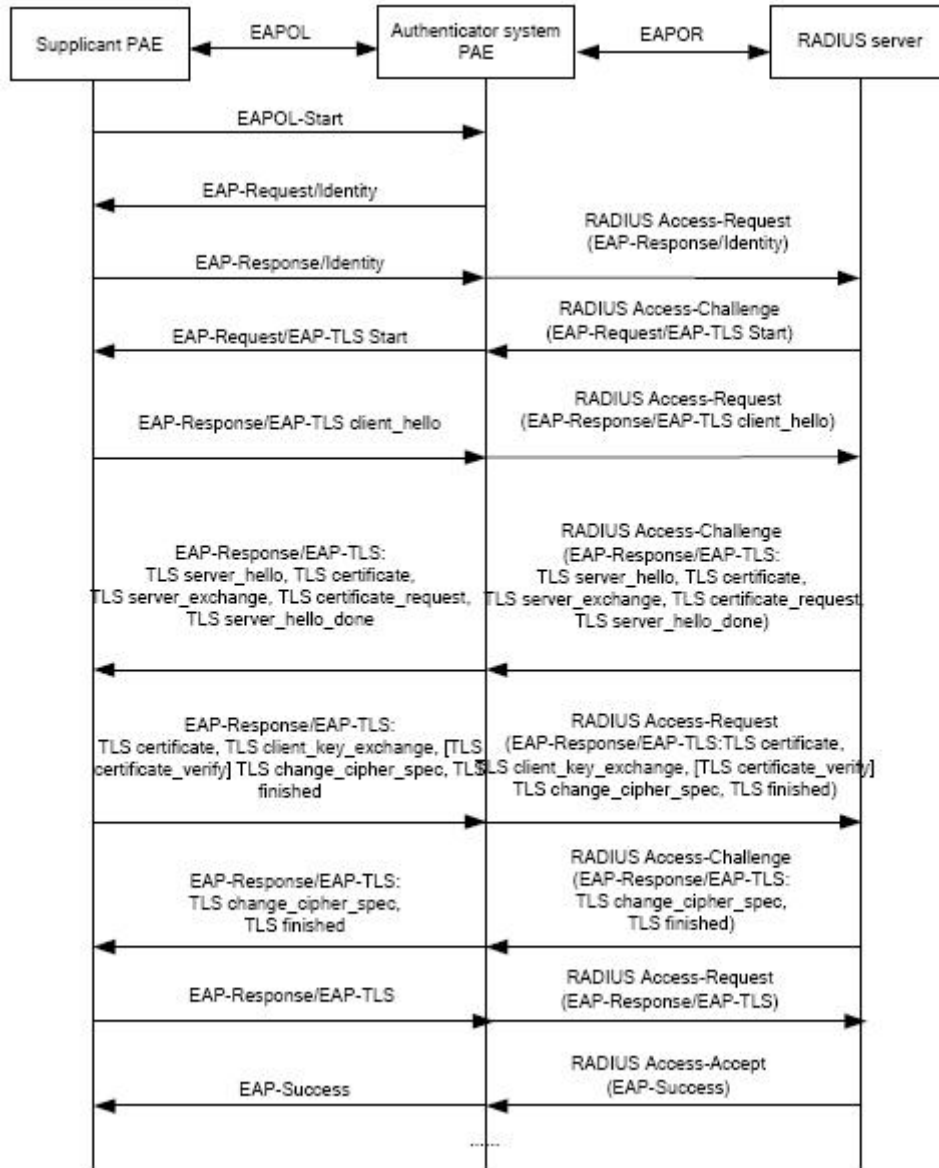

Figure 6- 10 the Authentication Flow of 802.1x EAP-TLS

3. EAP-TTLS Authentication Method

EAP-TTLS is a product of the cooperation of Funk Software and Certicom. It can provide an authentication as strong as that provided by EAP-TLS, but without requiring users to have their own digital certificate. The only request is that the Radius server should have a digital certificate. The authentication of users' identity is implemented with passwords transmitted in a safely encrypted tunnel established via the certificate of the authentication server. Any kind of authentication request including EAP, PAP and MS-CHAPV2 can be transmitted within TTLS tunnels.

4. PEAP Authentication Method

EAP-PEAP is brought up by Cisco, Microsoft and RAS Security as a recommended open standard. It has long been utilized in products and provides very good security. Its design of protocol and security is similar to that of EAP-TTLS, using a server's PKI certificate to establish a safe TLS tunnel in order to protect user authentication.

The following figure illustrates the basic operation flow of PEAP authentication method.

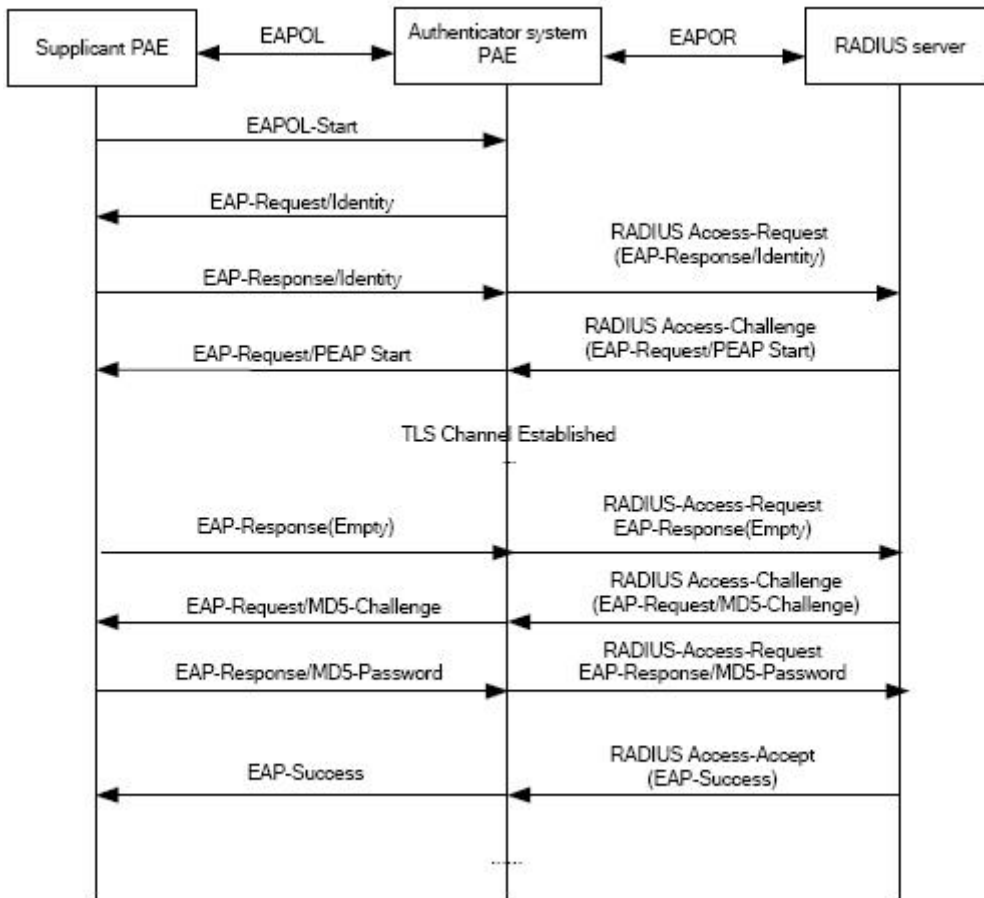

Figure 6- 11 the Authentication Flow of 802.1x PEAP

7.3.1.5.2 EAP Termination Mode

In this mode, EAP messages will be terminated in the access control unit and mapped into RADIUS messages, which is used to implement the authentication, authorization and fee-counting. The basic operation flow is illustrated in the next figure.

In EAP termination mode, the access control unit and the RADIUS server can use PAP or CHAP authentication method. The following figure will demonstrate the basic operation flow using CHAP authentication method.

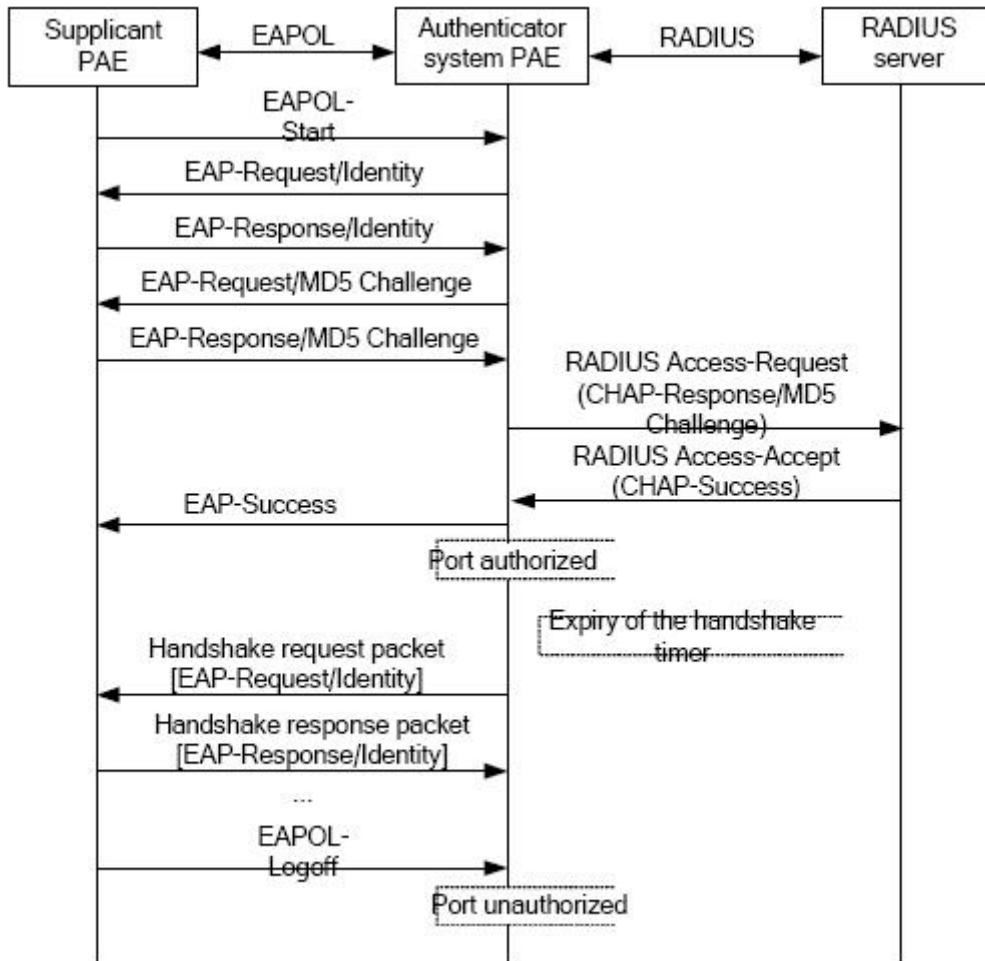

Figure 6- 12 the Authentication Flow of 802.1x EAP Termination Mode

7.3.1.6 The Extension and Optimization of 802.1x

Besides supporting the port- based access authentication method specified by the protocol, devices also extend and optimize it when implementing the EAP relay mode and EAP termination mode of 802.1x.

- ☞ Supports some applications in the case of which one physical port can have more than one users
- ☞ There are three access control methods (the methods to authenticate users): port-based, MAC-based and user-based (IP address+ MAC address+ port).
 - When the port-based method is used, as long as the first user of this port passes the authentication, all the other users can access the network resources without being authenticated. However, once the first user is offline, the network won't be available to all the other users.
 - When the MAC-based method is used, all the users accessing a port should be authenticated separately, only those pass the authentication can access the network,

while the others can not. When one user becomes offline, the other users will not be affected.

- When the user-based (IP address+ MAC address+ port) method is used, all users can access limited resources before being authenticated. There are two kinds of control in this method: standard control and advanced control. The user-based standard control will not restrict the access to limited resources, which means all users of this port can access limited resources before being authenticated. The user-based advanced control will restrict the access to limited resources, only some particular users of the port can access limited resources before being authenticated. Once those users pass the authentication, they can access all resources.

Attention: when using private supplicant systems, user-based advanced control is recommended to effectively prevent ARP cheat.

For the maximum number of the authenticated users, the maximum number of IPv4 users supported by user-based is 700, the maximum number of IPv6 users supported by user-based is 1400. mac-based relates to ratelimit value of switch, it can supports 4000 authenticated users, but it is recommended that the number of the authenticated users should not exceed 2000

7.3.1.7 The Features of VLAN Allocation

1. Auto VLAN

Auto VLAN feature enables RADIUS server to change the VLAN to which the access port belongs, based on the user information and the user access device information. When an 802.1x user passes authentication on the server, the RADIUS server will send the authorization information to the device, if the RADIUS server has enabled the VLAN-assigning function, then the following attributes should be included in the Access-Accept messages:

- 👉 Tunnel-Type = VLAN (13)
- 👉 Tunnel-Medium-Type = 802 (6)
- 👉 Tunnel-Private-Group-ID = VLANID

The VLANID here means the VID of VLAN, ranging from 1 to 4094. For example, Tunnel-Private-Group-ID = 30 means VLAN 30.

When the switch receives the assigned Auto VLAN information, the current Access port will leave the VLAN set by the user and join Auto VLAN.

Auto VLAN won't change or affect the port's configuration. But the priority of Auto VLAN is higher than that of the user-set VLAN, that is Auto VLAN is the one takes effect when the authentication is finished, while the user-set VLAN do not work until the user become offline.

Notes: At present, Auto VLAN can only be used in the port-based access control mode, and on the ports whose link type is Access.

2. Guest VLAN

Guest VLAN feature is used to allow the unauthenticated user to access some specified

resources.

The user authentication port belongs to a default VLAN (Guest VLAN) before passing the 802.1x authentication, with the right to access the resources within this VLAN without authentication. But the resources in other networks are beyond reach. Once authenticated, the port will leave Guest VLAN, and the user can access the resources of other networks.

In Guest VLAN, users can get 802.1x supplicant system software, update supplicant system or update some other applications (such as anti-virus software, the patches of operating system). The access device will add the port into Guest VLAN if there is no supplicant getting authenticated successfully in a certain stretch of time because of lacking exclusive authentication supplicant system or the version of the supplicant system being too low.

Once the 802.1x feature is enabled and the Guest VLAN is configured properly, a port will be added into Guest VLAN, just like Auto VLAN, if there is no response message from the supplicant system after the device sends more authentication-triggering messages than the upper limit (EAP-Request/Identity) from the port.

- ✎ The authentication server assigns an Auto VLAN, and then the port leaves Guest VLAN and joins the assigned Auto VLAN. When the user becomes offline, the port will be allocated to the specified Guest VLAN again.
- ✎ The authentication server assigns an Auto VLAN, and then the port leaves Guest VLAN and joins the specified VLAN. When the user becomes offline, the port will be allocated to the specified Guest VLAN again.

7.3.2 802.1x Configuration Task List

802.1x Configuration Task List:

1. Enable IEEE 802.1x function
2. Access management unit property configuration
 - 1) Configure port authentication status
 - 2) Configure access management method for the port: MAC-based or port-based
 - 3) Configure expanded 802.1x function
3. User access devices related property configuration (optional)

1. Enable 802.1x function

Command	Explanation
Global Mode	
dot1x enable no dot1x enable	Enables the 802.1x function in the switch and ports; the no command disables the 802.1x function.
dot1x privateclient enable no dot1x privateclient enable	Enables the switch force client software using private 802.1x authentication packet format. The no command will disable this function.
dot1x user free-resource	Sets free access network resource for unauthorized dot1x

<prefix> <mask> no dot1x user free-resource	user. The no command close the resource.
dot1x unicast enable no dot1x unicast enable	Enable the 802.1x unicast passthrough function of switch; the no operation of this command will disable this function.

2. Access management unit property configuration

1) Configure port authentication status

Command	Explanation
Port Mode	
dot1x port-control {auto force-authorized force-una nauthorized } no dot1x port-control	Sets the 802.1x authentication mode; the no command restores the default setting.

2) Configure port access management method

Command st-vlan <vlanID>	Explanation Sets the guest vlan of the specified port; the no command is used to delete the guest vlan.
Port Mode uest-vlan	
dot1x port-method macbased portbased userbased {standard advanced } no dot1x port-method	Sets the port access management method based authentication mode; the no command disables this function.
dot1x max-user macbased <number> no dot1x max-user macbased	Sets the maximum number of access users for the specified port; the no command restores the default setting of allowing 1 user.
dot1x max-user userbased <number> no dot1x max-user userbased	Set the upper limit of the number of users allowed accessing the specified port, only used when the access control mode of the port is userbased; the no command is used to reset the limit to 10 by default.

3) Configure expanded 802.1x function

Command	Explanation
Global Mode	
dot1x macfilter enable no dot1x macfilter enable	Enables the 802.1x address filter function in the switch; the no command disables the 802.1x address filter function.
dot1x macbased port-down-flush no dot1x macbased port-down-flush	Enables this command, when the dot1x certification according to mac is down, delete the user who passed the certification of the port; The no command does not make the down operation.
dot1x accept-mac <mac-address> [interface <interface-name>] no dot1x accept-mac <mac-address>	Adds 802.1x address filter table entry, the no command deletes 802.1x filter address table entries.

[interface <interface-name>]	
dot1x eapor enable no dot1x eapor enable	Enables the EAP relay authentication function in the switch; the no command sets EAP local end authentication.

3. Supplicant related property configuration

Command	Explanation
Global Mode	
dot1x max-req <count> no dot1x max-req	Sets the number of EAP request/MD5 frame to be sent before the switch re-initials authentication on no supplicant response, the no command restores the default setting.
dot1x re-authentication no dot1x re-authentication	Enables periodical supplicant authentication; the no command disables this function.
dot1x timeout quiet-period <seconds> no dot1x timeout quiet-period	Sets time to keep silent on port authentication failure; the no command restores the default value.
dot1x timeout re-authperiod <seconds> no dot1x timeout re-authperiod	Sets the supplicant re-authentication interval; the no command restores the default setting.
dot1x timeout tx-period <seconds> no dot1x timeout tx-period	Sets the interval for the supplicant to re-transmit EAP request/identity frame; the no command restores the default setting.
dot1x re-authenticate [interface <interface-name>]	Enables IEEE 802.1x re-authentication (no wait timeout requires) for all ports or a specified port.

7.3.3 802.1x Application Example

7.3.3.1 Examples of Guest Vlan Applications

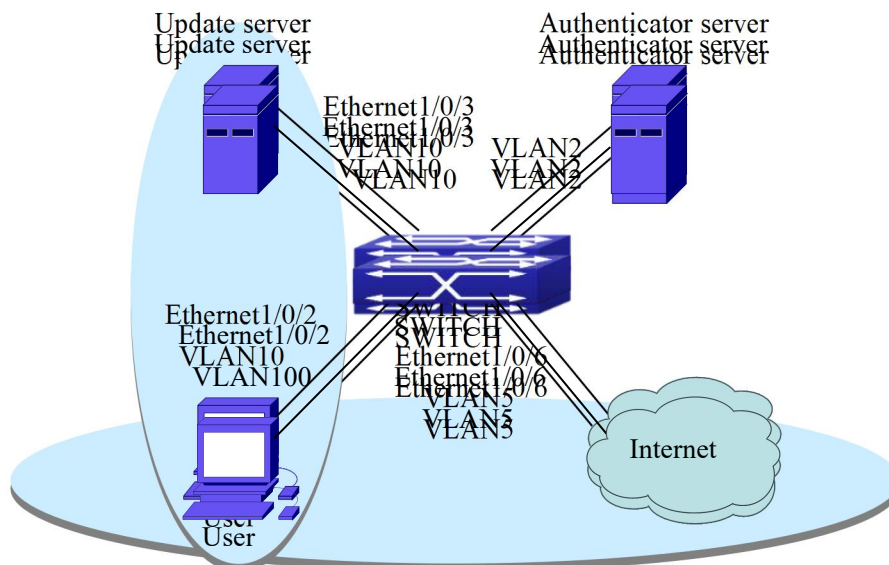

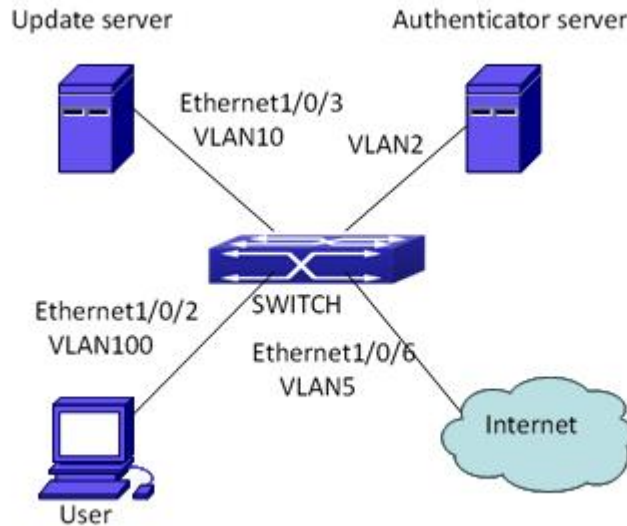

Fig 2- 13 The Network Topology of Guest VLAN

Notes: in the figures in this session, E2 means Ethernet 1/0/2, E3 means Ethernet 1/0/3 and E6 means Ethernet 1/0/6.

As showed in the next figure, a switch accesses the network using 802.1x authentication, with a RADIUS server as its authentication server. Ethernet1/0/2, the port through which the user accesses the switch belongs to VLAN100; the authentication server is in VLAN2;

Update Server, being in VLAN10, is for the user to download and update supplicant system software; Ethernet1/0/6, the port used by the switch to access the Internet is in

VLAN5.

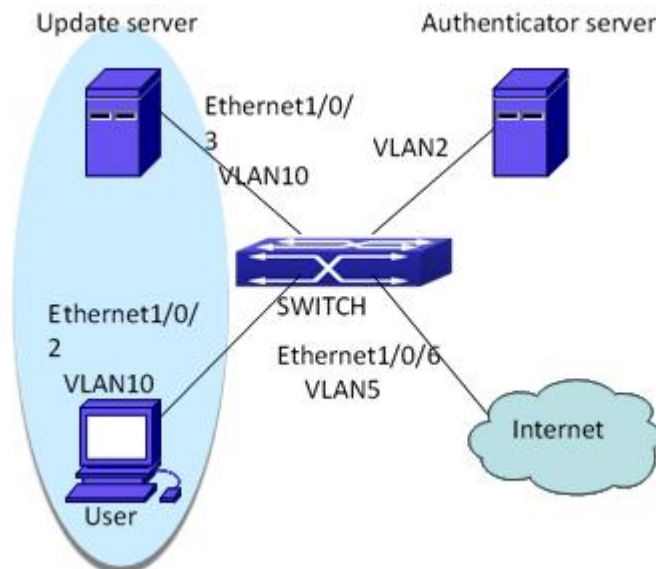

Fig 2- 14 User Joining Guest VLAN

As illustrated in the up figure, on the switch port Ethernet1/0/2, the 802.1x feature is enabled, and the VLAN10 is set as the port's Guest VLAN. Before the user gets authenticated or when the user fails to do so, port Ethernet1/0/2 is added into VLAN10, allowing the user to access the Update Server.

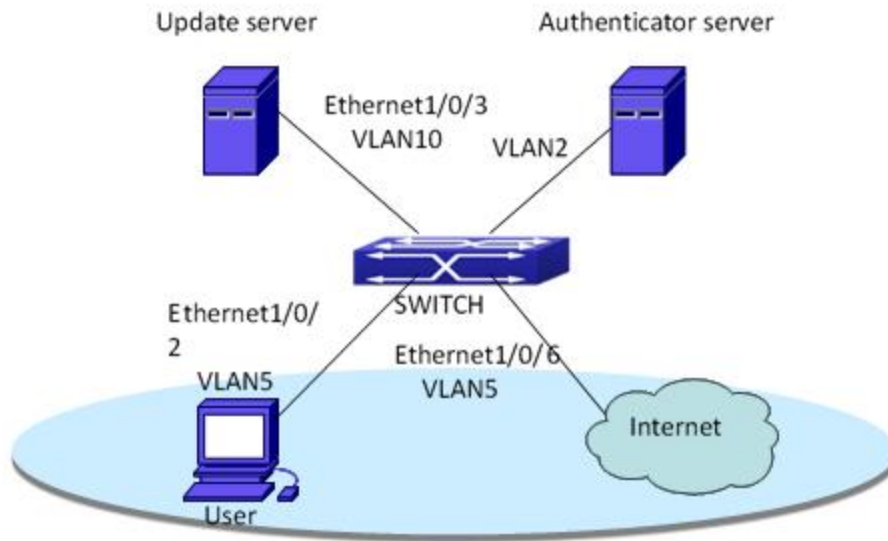

Fig 2- 15 User Being Online, VLAN Being Offline

As illustrated in the up figure, when the users become online after a successful authentication, the authentication server will assign VLAN5, which makes the user and Ethernet1/0/6 both in VLAN5, allowing the user to access the Internet.

The following are configuration steps:

Configure RADIUS server.

```
Switch(config)#radius-server authentication host 10.1.1.3
```

```
Switch(config)#radius-server accounting host 10.1.1.3
```

```
Switch(config)#radius-server key test
```

```
Switch(config)#aaa enable
```

```
Switch(config)#aaa-accounting enable
```

Create VLAN100.

```
Switch(config)#vlan 100
```

Enable the global 802.1x function

```
Switch(config)#dot1x enable
```

Enable the 802.1x function on port Ethernet1/0/2

```
Switch(config)#interface ethernet1/0/2
```

```
Switch(Config-If-Ethernet1/0/2)#dot1x enable
```

Set the link type of the port as access mode.

```
Switch(Config-If-Ethernet1/0/2)#switch-port mode access
```

Set the access control mode on the port as portbased.

```
Switch(Config-If-Ethernet1/0/2)#dot1x port-method portbased
```

Set the access control mode on the port as auto.

```
Switch(Config-If-Ethernet1/0/2)#dot1x port-control auto

# Set the port's Guest VLAN as 100.
Switch(Config-If-Ethernet1/0/2)#dot1x guest-vlan 100
Switch(Config-If-Ethernet1/0/2)#exit
```

Using the command of **show running-config** or **show interface ethernet1/0/2**, users can check the configuration of Guest VLAN. When there is no online user, no failed user authentication or no user gets offline successfully, and more authentication-triggering messages (EAP-Request/Identity) are sent than the upper limit defined, users can check whether the Guest VLAN configured on the port takes effect with the command **show vlan id 100**.

7.3.3.2 Examples of IPv4 Radius Applications

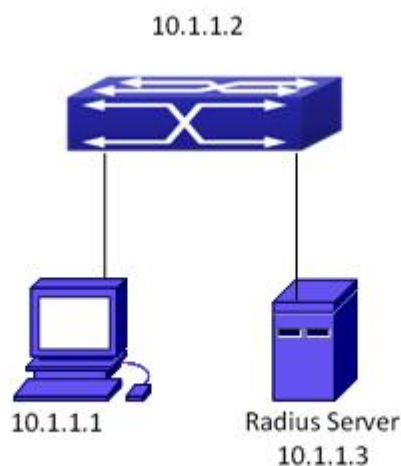

Figure 6- 13 IEEE 802.1x Configuration Example Topology

The PC is connecting to port 1/0/2 of the switch; IEEE 802.1x authentication is enabled on port 1/0/2; the access mode is the default MAC-based authentication. The switch IP address is 10.1.1.2. Any port other than port 1/0/2 is used to connect to RADIUS authentication server, which has an IP address of 10.1.1.3, and use the default port 1812 for authentication and port 1813 for accounting. IEEE 802.1x authentication client software is installed on the PC and is used in IEEE 802.1x authentication.

The configuration procedures are listed below:

```
Switch(config)#interface vlan 1
Switch(Config-if-vlan1)#ip address 10.1.1.2 255.255.255.0
Switch(Config-if-vlan1)#exit
Switch(config)#radius-server authentication host 10.1.1.3
Switch(config)#radius-server accounting host 10.1.1.3
Switch(config)#radius-server key test
```

```
Switch(config)#aaa enable
Switch(config)#aaa-accounting enable
Switch(config)#dot1x enable
Switch(config)#interface ethernet 1/0/2
Switch(Config-Ethernet1/0/2)#dot1x enable
Switch(Config-Ethernet1/0/2)#dot1x port-control auto
Switch(Config-Ethernet1/0/2)#exit
```

7.3.3.3 Examples of IPv6 Radius Application

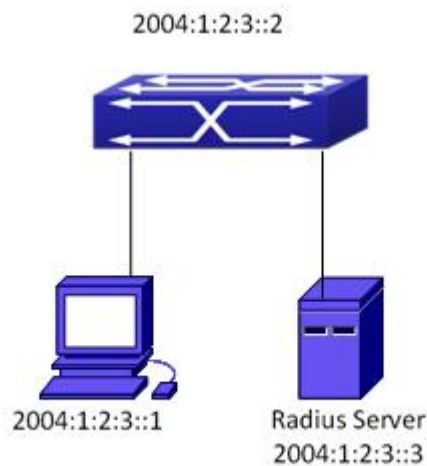

Figure 6- 14 IPv6 Radius

Connect the computer to the interface 1/0/2 of the switch, and enable IEEE802.1x on interface1/0/2. Use MAC based authentication. Configure the IP address of the switch as 2004:1:2:3::2, and connect the switch with any interface except interface 1/0/2 to the RADIUS authentication server. Configure the IP address of the RADIUS server to be 2004:1:2:3::3. Use the default ports 1812 and 1813 for authentication and accounting respectively. Install the IEEE802.1x authentication client software on the computer, and use the client for IEEE802.1x authentication.

The detailed configurations are listed as below:

```
Switch(config)#interface vlan 1
Switch(Config-if-vlan1)#ipv6 address 2004:1:2:3::2/64
Switch(Config-if-vlan1)#exit
Switch(config)#radius-server authentication host 2004:1:2:3::3
Switch(config)#radius-server accounting host 2004:1:2:3::3
Switch(config)#radius-server key test
Switch(config)#aaa enable
Switch(config)#aaa-accounting enable
Switch(config)#dot1x enable
Switch(config)#interface ethernet 1/0/2
Switch(Config-If-Ethernet1/0/2)#dot1x enable
Switch(Config-If-Ethernet1/0/2)#dot1x port-control auto
Switch(Config-If-Ethernet1/0/2)#exit
```

7.3.4 802.1x Troubleshooting

It is possible that 802.1x be configured on ports and 802.1x authentication be set to auto, t switch can't be to authenticated state after the user runs 802.1x supplicant software. Here are some possible causes and solutions:

- ☞ If 802.1x cannot be enabled for a port, make sure the port is not executing MAC binding, or configured as a port aggregation. To enable the 802.1x authentication, the above functions must be disabled.
- ☞ If the switch is configured properly but still cannot pass through authentication, connectivity between the switch and RADIUS server, the switch and 802.1x client should be verified, and the port and VLAN configuration for the switch should be checked, too.
- ☞ Check the event log in the RADIUS server for possible causes. In the event log, not only unsuccessful logins are recorded, but prompts for the causes of unsuccessful login. If the event log indicates wrong authenticator password, radius-server key parameter shall be modified; if the event log indicates no such authenticator, the authenticator needs to be added to the RADIUS server; if the event log indicates no such login user, the user login ID and password may be wrong and should be verified and input again.

7.4 The Number Limitation Function of MAC and IP in Port, VLAN

7.4.1 Introduction to the Number Limitation Function of MAC and IP in Port, VLAN

MAC address list is used to identify the mapping relationship between the destination MAC addresses and the ports of switch. There are two kinds of MAC addresses in the list: static MAC address and dynamic MAC address. The static MAC address is set by users, having the highest priority (will not be overwritten by dynamic MAC address), and will always be effective; dynamic MAC address is learnt by the switch through transmitting data frames, and will only be effective in a specific time range. When the switch receives a data framed waiting to be transmitted, it will study the source MAC address of the data frame, build a mapping relationship with the receiving port, and then look up the MAC address list for the destination MAC address. If any matching list entry is found, the switch will transmit the data frame via the corresponding port, or, the switch will broadcast the data frame over the VLAN it belongs to. If the dynamically learnt MAC address matches no transmitted data in a long time, the switch will delete it from the MAC address list.

Usually the switch supports both the static configuration and dynamic study of MAC address, which means each port can have more than one static set MAC addresses and dynamically learnt MAC addresses, and thus can implement the transmission of data traffic between port and known MAC addresses. When a MAC address becomes out of date, it will be dealt with broadcast. No number limitation is put on MAC address of the ports of our current switches; every port can have several MAC addressed either by configuration or study, until the hardware list entries are exhausted. To avoid too many MAC addresses of a port, we should limit the number of MAC addresses a port can have.

For each INTERFACE VLAN, there is no number limitation of IP; the upper limit of the number of IP is the upper limit of the number of user on an interface, which is, at the same time, the upper limit of ARP and ND list entry. There is no relative configuration command can be used to control the sent number of these list entries. To enhance the security and the controllability of our products, we need to control the number of MAC address on each port and the number of ARP, ND on each INTERFACE VLAN. The number of static or dynamic MAC address on a port should not exceed the configuration. The number of user on each VLAN should not exceed the configuration, either.

Limiting the number of MAC and ARP list entry can avoid DOS attack to a certain extent. When malicious users frequently do MAC or ARP cheating, it will be easy for them to fill the MAC and ARP list entries of the switch, causing successful DOS attacks.

To summer up, it is very meaningful to develop the number limitation function of MAC and IP in port, VLAN. Switch can control the number of MAC address of ports and the number ARP, ND list entry of ports and VLAN through configuration commands.

Limiting the number of dynamic MAC and IP of ports:

1. Limiting the number of dynamic MAC. If the number of dynamically learnt MAC address by the switch is already larger than or equal with the max number of dynamic MAC address, then shutdown the MAC study function on this port, otherwise, the port can continue its study.

2. Limiting the number of dynamic IP. If the number of dynamically learnt ARP and ND by the switch is already larger than or equal with the max number of dynamic ARP and ND, then shutdown the ARP and ND study function of this port, otherwise, the port can continue its study.

Limiting the number of MAC, ARP and ND of interfaces:

1. Limiting the number of dynamic MAC. If the number of dynamically learnt MAC address by the VLAN of the switch is already larger than or equal with the max number of dynamic MAC address, then shutdown the MAC study function of all the ports in this VLAN, otherwise, all the ports in this VLAN can continue their study (except special ports).

2. Limiting the number of dynamic IP. If the number of dynamically learnt ARP and ND by the switch is already larger than or equal with the max number of dynamic ARP and ND, then the VLAN will not study any new ARP or ND, otherwise, the study can be continued.

7.4.2 The Number Limitation Function of MAC and IP in Port, VLAN Configuration Task Sequence

1. Enable the number limitation function of MAC and IP on ports
2. Enable the number limitation function of MAC and IP in VLAN

3. Configure the timeout value of querying dynamic MAC
4. Configure the violation mode of ports
5. Display and debug the relative information of number limitation of MAC and IP on ports

1. Enable the number limitation function of MAC and IP on ports

Command	Explanation
Port configuration mode	
switchport mac-address dynamic maximum <value> no switchport mac-address dynamic maximum	Enable and disable the number limitation function of MAC on the ports.
switchport arp dynamic maximum <value> no switchport arp dynamic maximum	Enable and disable the number limitation function of ARP on the ports.
switchport nd dynamic maximum <value> no switchport nd dynamic maximum	Enable and disable the number limitation function of ND on the ports.

2. Enable the number limitation function of MAC and IP in VLAN

Command	Explanation
VLAN configuration mode	
vlan mac-address dynamic maximum <value> no vlan mac-address dynamic maximum	Enable and disable the number limitation function of MAC in the VLAN.
Interface configuration mode	
ip arp dynamic maximum <value> no ip arp dynamic maximum	Enable and disable the number limitation function of ARP in the VLAN.
ipv6 nd dynamic maximum <value> no ipv6 nd dynamic maximum	Enable and disable the number limitation function of NEIGHBOR in the VLAN.

3. Configure the timeout value of querying dynamic MAC

Command	Explanation
Global configuration mode	
mac-address query timeout <seconds>	Configure the timeout value of querying dynamic MAC.

4. Configure the violation mode of ports

Command	Explanation
Port mode	
switchport mac-address violation {protect shutdown} [recovery <5-3600>] no switchport mac-address violation	Set the violation mode of the port, the no command restores the violation mode to protect .

5. Display and debug the relative information of number limitation of MAC and IP on ports

Command	Explanation
Admin mode	
show mac-address dynamic count {vlan <vlan-id> interface ethernet <portName> }	Display the number of dynamic MAC in corresponding ports and VLAN.
show arp-dynamic count {vlan <vlan-id> interface ethernet <portName> }	Display the number of dynamic ARP in corresponding ports and VLAN.
show nd-dynamic count {vlan <vlan-id> interface ethernet <portName> }	Display the number of dynamic NEIGHBOUR in corresponding ports and VLAN.
debug switchport mac count no debug switchport mac count	All kinds of debug information when limiting the number of MAC on ports.
debug switchport arp count no debug switchport arp count	All kinds of debug information when limiting the number of ARP on ports.
debug switchport nd count no debug switchport nd count	All kinds of debug information when limiting the number of NEIGHBOUR on ports.
debug vlan mac count no debug vlan mac count	All kinds of debug information when limiting the number of MAC in VLAN.
debug ip arp count no debug ip arp count	All kinds of debug information when limiting the number of ARP in VLAN.
debug ipv6 nd count no debug ipv6 nd count	All kinds of debug information when limiting the number of MAC in VLAN.

7.4.3 The Number Limitation Function of MAC and IP in Port, VLAN Typical Examples

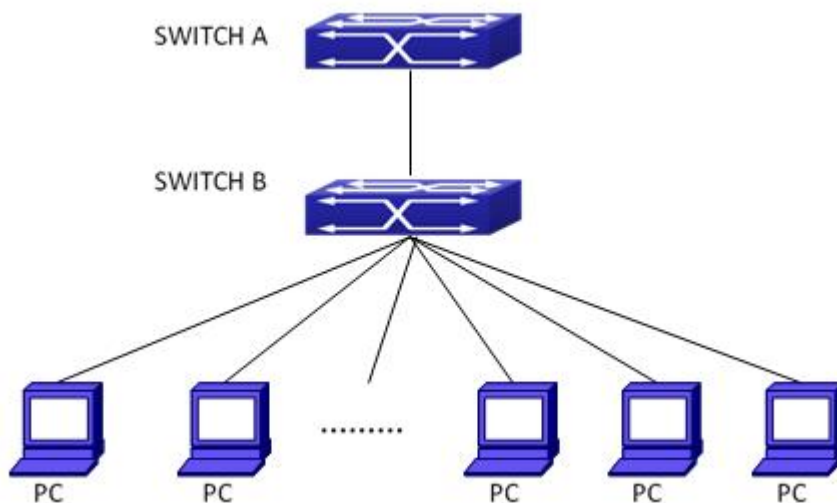

Figure 6- 15 The Number Limitation of MAC and IP in Port, VLAN Typical Configuration Example

In the network topology above, SWITCH B connects to many PC users, before enabling the number limitation function of MAC and IP in Port, VLAN, if the system hardware has no other limitation, SWITCH A and SWITCH B can get the MAC, ARP, ND list entries of all the PC, so limiting the MAC, ARP list entry can avoid DOS attack to a certain extent. When malicious users frequently do MAC, ARP cheating, it will be easy for them to fill the MAC, ARP list entries of the switch, causing successful DOS attacks. Limiting the MAC, ARP, ND list entry can prevent DOS attack.

On port 1/0/1 of SWITCH A, set the max number can be learnt of dynamic MAC address as 20, dynamic ARP address as 20, NEIGHBOR list entry as 10. In VLAN 1, set the max number of dynamic MAC address as 30, of dynamic ARP address as 30, NEIGHBOR list entry as 20.

SWITCH A configuration task sequence:

```
Switch (config)#interface ethernet 1/0/1
Switch (Config-If-Ethernet1/0/1)#switchport mac-address dynamic maximum 20
Switch (Config-If-Ethernet1/0/1)#switchport arp dynamic maximum 20
Switch (Config-If-Ethernet1/0/1)#switchport nd dynamic maximum 10
Switch (Config-if-Vlan1)#vlan mac-address dynamic maximum 30
```

7.4.4 The Number Limitation Function of MAC and IP in Port, VLAN Troubleshooting Help

The number limitation function of MAC and IP in Port, VLAN is disabled by default, if users need to limit the number of user accessing the network, they can enable it. If the number limitation function of MAC address can not be configured, please check whether Spanning-tree, dot1x, TRUNK is running on the switch and whether the port is configured as a MAC-binding port. The number limitation function of MAC address is mutually exclusive to these configurations, so if the users need to enable the number limitation function of MAC address on the port, they should check these functions mentioned above on this port are disabled.

If all the configurations are normal, after enabling the number limitation function of MAC and IP in Port, VLAN, users can use debug commands to debug every limitation, check the details of number limitations and judge whether the number limitation function is correct. If there is any problem, please sent result to technical service center.

7.5 AM

7.5.1 Introduction to AM Function

AM (Access Management) means that when a switch receives an IP or ARP message, it will compare the information extracted from the message (such as source IP address or source MAC-IP address) with the configured hardware address pool. If there is an entry in the address pool matching the information (source IP address or source MAC-IP address), the message will be forwarded, otherwise, dumped. The reason why source-IP-based AM should be supplemented by source-MAC-IP-based AM is that IP address of a host might change. Only with a bound IP, can users change the IP of the host into forwarding IP, and hence enable the messages from the host to be forwarded by the switch. Given the fact that MAC-IP can be exclusively bound with a host, it is necessary to make MAC-IP bound with a host for the purpose of preventing users from maliciously modifying host IP to forward the messages from their hosts via the switch.

With the interface-bound attribute of AM, network managers can bind the IP (MAC-IP) address of a legal user to a specified interface. After that, only the messages sending by users with specified IP (MAC-IP) addresses can be forwarded via the interface, and thus strengthen the monitoring of the network security.

7.5.2 AM Function Configuration Task List

1. Enable AM function
2. Enable AM function on an interface
3. Configure the forwarding IP
4. Configure the forwarding MAC-IP
5. Delete all of the configured IP or MAC-IP or both
6. Display relative configuration information of AM

1. Enable AM function

Command	Explanation
Global Mode	
am enable no am enable	Globally enable or disable AM function.

2. Enable AM function on an interface

Command	Explanation
Port Mode	
am port no am port	Enable/disable AM function on the port. When the AM function is enabled on the port, no IP or ARP message will be forwarded by default.

3. Configure the forwarding IP

Command	Explanation

Port Mode	
am ip-pool <ip-address> <num> no am ip-pool <ip-address> <num>	Configure the forwarding IP of the port.

4. Configure the forwarding MAC-IP

Command	Explanation
Port Mode	
am mac-ip-pool <mac-address> <ip-address> no am mac-ip-pool <mac-address> <ip-address>	Configure the forwarding MAC-IP of the port.

5. Delete all of the configured IP or MAC-IP or both

Command	Explanation
Global Mode	
no am all [ip-pool mac-ip-pool]	Delete MAC-IP address pool or IP address pool or both pools configured by all users.

6. Display relative configuration information of AM

Command	Explanation
Global Configuration Mode	
show am [interface <interface-name>]	Display the AM configuration information of one port or all ports.

7.5.3 AM Function Example

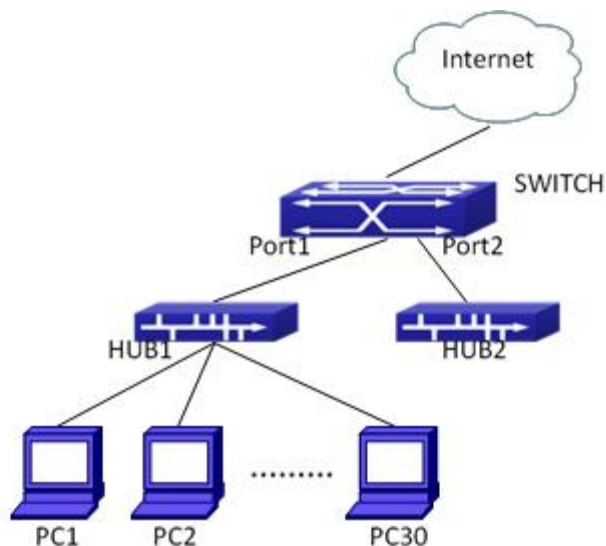

Figure 6- 16 a typical configuration example of AM function

In the topology above, 30 PCs, after converged by HUB1, connect with interface1 on the switch. The IP addresses of these 30 PCs range from 100.10.10.1 to 100.10.10.30. Considering

security, the system manager will only take user with an IP address within that range as legal ones. And the switch will only forward data packets from legal users while dumping packets from other users.

According to the requirements mentioned above, the switch can be configured as follows:

```
Switch(config)#am enable
Switch(config)#interface ethernet1/0/1
Switch(Config-If-Ethernet 1/0/1)#am port
Switch(Config-If-Ethernet 1/0/1)#am ip-pool 10.10.10.1 10
```

7.5.4 AM Function Troubleshooting

AM function is disabled by default, and after it is enabled, relative configuration of AM can be made.

Users can view the current AM configuration with “show am” command, such as whether the AM is enabled or not, and AM information on each interface, they can also use “**show am [interface <interface-name>]**” command to check the AM configuration information on a specific interface.

If any operational error happens, the system will display detailed corresponding prompt.

7.6 Security Feature

7.6.1 Introduction to Security Feature

Before introducing the security features, we here first introduce the DoS. The DoS is short for Denial of Service, which is a simple but effective destructive attack on the internet. The server under DoS attack will drop normal user data packet due to non-stop processing the attacker’s data packet, leading to the denial of the service and worse can lead to leak of sensitive data of the server.

Security feature refers to applications such as protocol check which is for protecting the server from attacks such as DoS. The protocol check allows the user to drop matched packets based on specified conditions. The security features provide several simple and effective protections against Dos attacks while acting no influence on the linear forwarding performance of the switch.

7.6.2 Security Feature Configuration

7.6.2.1 Prevent IP Spoofing Function Configuration Task

Sequence

1. Enable the IP spoofing function.

Command	Explanation
Global Mode	
[no] dosattack-check srcip-equal-dstip enable	Enable/disable the function of checking if the IP source address is the same as the destination address.

7.6.2.2 Prevent TCP Unauthorized Label Attack Function

Configuration Task Sequence

1. Enable the anti TCP unauthorized label attack function

Command	Explanation
Global Mode	
[no] dosattack-check tcp-flags enable	Enable/disable checking TCP label function.

7.6.2.3 Anti Port Cheat Function Configuration Task Sequence

1. Enable the anti port cheat function

Command	Explanation
Global Mode	
[no] dosattack-check srcport-equal-dstport enable	Enable/disable the prevent-port-cheat function.

7.6.2.4 Prevent ICMP Fragment Attack Function Configuration

Task Sequence

1. Enable the prevent ICMP fragment attack function

--	--

Command	Explanation
Global Mode	
[no] dosattack-check icmp-attacking enable	Enable/disable the prevent ICMP fragment attack function.

7.6.2.5 IPv4 Destination IP Check For Illegal Function

Configuration Task Sequence

1. Enable IPv4 destination IP checking for illegal function

Command	Explanation
Global Mode	
invalid-dip-drop {enable disable}	Enable (disable) IPv4 destination IP checking for illegal function. Illegal destination IP includes X.X.X. 0, 127.X.X.X, 240.0.0.0~255.255.255.254.

7.6.3 Security Feature Example

Scenario:

The User has follows configuration requirements: the switch do not forward data packet whose source IP address is equal to the destination address, and those whose source port is equal to the destination port. Only the ping command with defaulted options is allowed within the IPv4 network, namely the ICMP request packet can not be fragmented and its net length is normally smaller than 100, enable IPv4 destination IP checking for illegal function.

Configuration procedure:

```
Switch(config)# dosattack-check srcip-equal-dstip enable
Switch(config)# dosattack-check srcport-equal-dstport enable
Switch(config)# dosattack-check ipv4-first-fragment enable
Switch(config)# dosattack-check icmp-attacking enable
Switch(config)# dosattack-check icmpV4-size 100
Switch(config)#invalid-dip-drop enable
```

7.7 TACACS+

7.7.1 Introduction to TACACS+

TACACS+ terminal access controller access control protocol is a protocol similar to the radius protocol for control the terminal access to the network. Three independent functions of Authentication, Authorization, Accounting are also available in this protocol. Compared with RADIUS, the transmission layer of TACACS+ protocol is adopted with TCP protocol, further with the packet head (except for standard packet head) encryption, this protocol is of a more reliable transmission and encryption characteristics, and is more adapted to security control.

According to the characteristics of the TACACS+ (Version 1.78), we provide TACACS+ authentication function on the switch, when the user logs, such as telnet, the authentication of user name and password can be carried out with TACACS+.

7.7.2 TACACS+ Configuration Task List

1. Configure the TACACS+ authentication key
2. Configure the TACACS+ server
3. Configure the TACACS+ authentication timeout time
4. Configure the IP address of the RADIUS NAS

1. Configure the TACACS+ authentication key

Command	Explanation
Global Mode	
tacacs-server key {0 7} <string> no tacacs-server key	Configure the TACACS+ server key; the “ no tacacs-server key ” command deletes the key.

2. Configure TACACS+ server

Command	Explanation
Global Mode	
tacacs-server authentication host <ip-address> [port <port-number>] [timeout <seconds>] [key {0 7} <string>] [primary] no tacacs-server authentication host <ip-address>	Configure the IP address, listening port number, the value of timeout timer and the key string of the TACACS+ server; the no form of this command deletes the TACACS+ authentication server.

3. Configure the TACACS+ authentication timeout time

Command	Explanation
Global Mode	
tacacs-server timeout <seconds> no tacacs-server timeout	Configure the authentication timeout for the TACACS+ server, the “ no tacacs-server timeout ” command restores the default configuration.

4. Configure the IP address of the TACACS+ NAS

Command	Explanation
Global Mode	

<code>tacacs-server nas-ipv4 <ip-address></code> <code>no tacacs-server nas-ipv4</code>	To configure the source IP address for the TACACS+ packets for the switch.
--	--

7.7.3 TACACS+ Scenarios Typical Examples

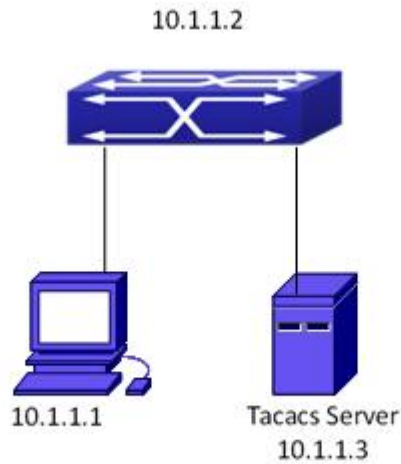

Figure 6- 17 TACACS Configuration

A computer connects to a switch, of which the IP address is 10.1.1.2 and connected with a TACACS+ authentication server; IP address of the server is 10.1.1.3 and the authentication port is defaulted at 49, set telnet log on authentication of the switch as tacacs local, via using TACACS+ authentication server to achieve telnet user authentication.

```
Switch(config)#interface vlan 1
Switch(Config-if-vlan1)#ip address 10.1.1.2 255.255.255.0
Switch(Config-if-vlan1)#exit
Switch(config)#tacacs-server authentication host 10.1.1.3
Switch(config)#tacacs-server key test
Switch(config)#authentication line vty login tacacs
```

7.7.4 TACACS+ Troubleshooting

In configuring and using TACACS+, the TACACS+ may fail to authentication due to reasons such as physical connection failure or wrong configurations. The user should ensure the following:

- ☞ First good condition of the TACACS+ server physical connection.
- ☞ Second all interface and link protocols are in the UP state (use “**show interface**” command).
- ☞ Then ensure the TACACS+ key configured on the switch is in accordance with the one configured on TACACS+ server.
- ☞ Finally ensure to connect to the correct TACACS+ server.

7.8 RADIUS

7.8.1 Introduction to RADIUS

7.8.1.1 AAA and RADIUS Introduction

AAA is short for Authentication, Authorization and Accounting, it provide a consistency framework for the network management safely. According to the three functions of Authentication, Authorization, Accounting, the framework can meet the access control for the security network: which one can visit the network device, which access-level the user can have and the accounting for the network resource.

RADIUS (Remote Authentication Dial in User Service), is a kind of distributed and client/server protocol for information exchange. The RADIUS client is usually used on network appliance to implement AAA in cooperation with 802.1x protocol. The RADIUS server maintains the database for AAA, and communicates with the RADIUS client through RADIUS protocol. The RADIUS protocol is the most common used protocol in the AAA framework.

7.8.1.2 Message structure for RADIUS

The RADIUS protocol uses UDP to deliver protocol packets. The packet format is shown as below.

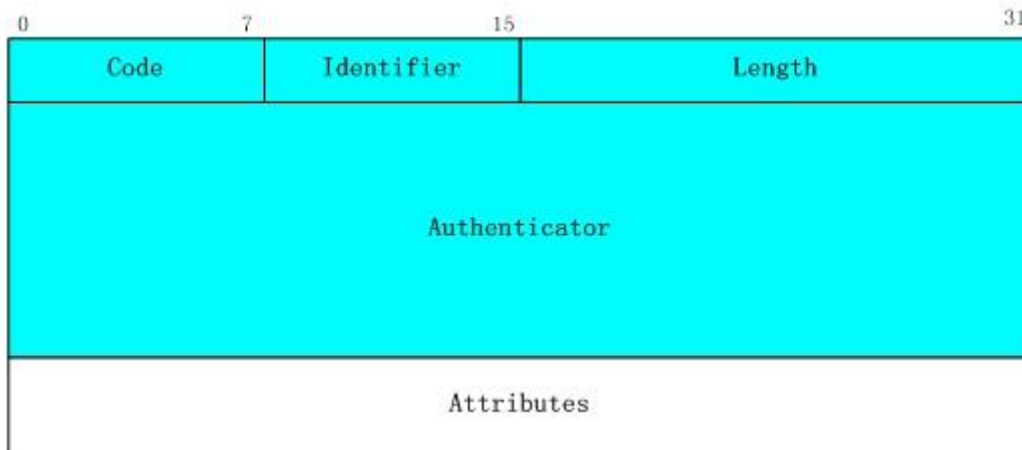

Figure 6- 18 Message structure for RADIUS

Code field(1octets): is the type of the RADIUS packet. Available value for the Code field is show as below:

- 1 Access-Request
- 2 Access-Accept
- 3 Access-Reject
- 4 Accounting-Request
- 5 Accounting-Response

11 Access-Challenge

Identifier field (1 octet): Identifier for the request and answer packets.

Length field (2 octets): The length of the overall RADIUS packet, including Code, Identifier, Length, Authenticator and Attributes

Authenticator field (16 octets): used for validation of the packets received from the RADIUS server. Or it can be used to carry encrypted passwords. This field falls into two kinds: the Request Authenticator and the Response Authenticator.

Attribute field: used to carry detailed information about AAA. An Attribute value is formed by Type, Length, and Value fields.

☞ Type field (1 octet), the type of the attribute value, which is shown as below:

Property	Type of property	Property	Type of property
1	User-Name	23	Framed-IPX-Network
2	User-Password	24	State
3	CHAP-Password	25	Class
4	NAS-IP-Address	26	Vendor-Specific
5	NAS-Port	27	Session-Timeout
6	Service-Type	28	Idle-Timeout
7	Framed-Protocol	29	Termination-Action
8	Framed-IP-Address	30	Called-Station-Id
9	Framed-IP-Netmask	31	Calling-Station-Id
10	Framed-Routing	32	NAS-Identifier
11	Filter-Id	33	Proxy-State
12	Framed-MTU	34	Login-LAT-Service
13	Framed-Compression	35	Login-LAT-Node
14	Login-IP-Host	36	Login-LAT-Group
15	Login-Service	37	Framed-AppleTalk-Link
16	Login-TCP-Port	38	Framed-AppleTalk-Network
17	(unassigned)	39	Framed-AppleTalk-Zone
18	Reply-Message	40-59	(reserved for accounting)
19	Callback-Number	60	CHAP-Challenge
20	Callback-Id	61	NAS-Port-Type
21	(unassigned)	62	Port-Limit
22	Framed-Route	63	Login-LAT-Port

☞ Length field (1 octet), the length in octets of the attribute including Type, Length and Value fields.

☞ Value field, value of the attribute whose content and format is determined by the type and length of the attribute.

7.8.2 RADIUS Configuration Task List

1. Enable the authentication and accounting function
2. Configure the RADIUS authentication key
3. Configure the RADIUS server
4. Configure the parameter of the RADIUS service
5. Configure the IP address of the RADIUS NAS

1. Enable the authentication and accounting function

Command	Explanation
Global Mode	
aaa enable no aaa enable	To enable the AAA authentication function. The no form of this command will disable the AAA authentication function.
aaa-accounting enable no aaa-accounting enable	To enable AAA accounting. The no form of this command will disable AAA accounting.
aaa-accounting update {enable disable}	Enable or disable the update accounting function.

2. Configure the RADIUS authentication key

Command	Explanation
Global Mode	
radius-server key {0 7} <string> no radius-server key	To configure the encryption key for the RADIUS server. The no form of this command will remove the configured key.

3. Configure the RADIUS server

Command	Explanation
Global Mode	
radius-server authentication host {<ipv4-address> <ipv6-address>} [port <port-number>] [key {0 7} <string>] [primary] [access-mode {dot1x telnet}] no radius-server authentication host {<ipv4-address> <ipv6-address>}	Specifies the IPv4/IPv6 address and the port number, whether be primary server for RADIUS accounting server; the no command deletes the RADIUS accounting server.
radius-server accounting host {<ipv4-address> <ipv6-address>} [port <port-number>] [key {0 7} <string>] [primary] no radius-server accounting host {<ipv4-address> <ipv6-address>}	Specifies the IPv4/IPv6 address and the port number, whether be primary server for RADIUS accounting server; the no command deletes the RADIUS accounting server.

4. Configure the parameter of the RADIUS service

Command	Explanation
Global Mode	
radius-server dead-time <minutes> no radius-server dead-time	To configure the interval that the RADIUS becomes available after it is down. The no form of this command will restore the default configuration.
radius-server retransmit <retries> no radius-server retransmit	To configure retry times for the RADIUS packets. The no form of this command restores the default configuration.
radius-server timeout <seconds> no radius-server timeout	To configure the timeout value for the RADIUS server. The no form of this command will restore the default configuration.
radius-server accounting-interim-update timeout <seconds> no radius-server accounting-interim-update timeout	To configure the update interval for accounting. The no form of this command will restore the default configuration.

5. Configure the IP address of the RADIUS NAS

Command	Explanation
Global Mode	
radius nas-ipv4 <ip-address> no radius nas-ipv4	To configure the source IP address for the RADIUS packets for the switch.
radius nas-ipv6 <ipv6-address> no radius nas-ipv6	To configure the source IPv6 address for the RADIUS packets for the switch.

7.8.3 RADIUS Typical Examples

7.8.3.1 IPv4 Radius Example

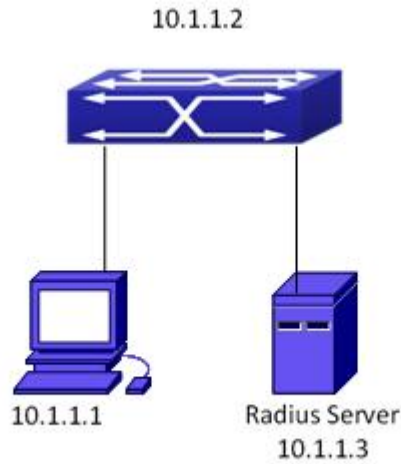

Figure 6- 19 The Topology of IEEE802.1x configuration

A computer connects to a switch, of which the IP address is 10.1.1.2 and connected with a RADIUS authentication server without Ethernet1/0/2; IP address of the server is 10.1.1.3 and the authentication port is defaulted at 1812, accounting port is defaulted at 1813.

Configure steps as below:

```
Switch(config)#interface vlan 1
Switch(Config-if-vlan1)#ip address 10.1.1.2 255.255.255.0
Switch(Config-if-vlan1)#exit
Switch(config)#radius-server authentication host 10.1.1.3
Switch(config)#radius-server accounting host 10.1.1.3
Switch(config)#radius-server key test
Switch(config)#aaa enable
Switch(config)#aaa-accounting enable
```

7.8.3.2 IPv6 RadiusExample

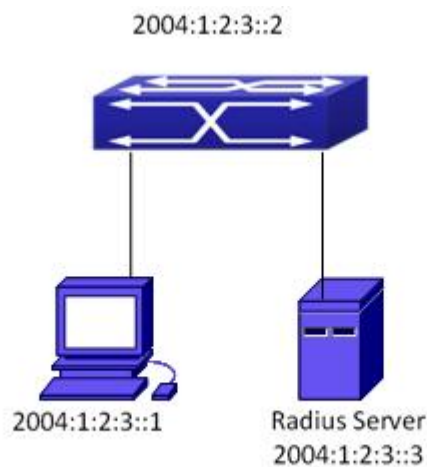

Figure 6- 20 The Topology of IPv6 Radius configuration

A computer connects to a switch, of which the IP address is 2004:1:2:3::2 and connected with a RADIUS authentication server without Ethernet1/0/2; IP address of the server is 2004:1:2:3::3 and the authentication port is defaulted at 1812, accounting port is defaulted at 1813.

Configure steps as below:

```
Switch(config)#interface vlan 1
Switch(Config-if-vlan1)#ipv6 address 2004:1:2:3::2/64
Switch(Config-if-vlan1)#exit
Switch(config)#radius-server authentication host 2004:1:2:3::3
Switch(config)#radius-server accounting host 2004:1:2:3::3
Switch(config)#radius-server key test
Switch(config)#aaa enable
Switch(config)#aaa-accounting enable
```

7.8.4 RADIUS Troubleshooting

In configuring and using RADIUS, the RADIUS may fail to authentication due to reasons such as physical connection failure or wrong configurations. The user should ensure the following:

- 👉 First make sure good condition of the RADIUS server physical connection
- 👉 Second all interface and link protocols are in the UP state (use “**show interface**” command)
- 👉 Then ensure the RADIUS key configured on the switch is in accordance with the one configured on RADIUS server
- 👉 Finally ensure to connect to the correct RADIUS server

If the RADIUS authentication problem remains unsolved, please use **debug aaa** and other debugging command and copy the DEBUG message within 3 minutes, send the recorded message to the technical server center of our company.

7.9 SSL

7.9.1 Introduction to SSL

As the computer networking technology spreads, the security of the network has been taking more and more important impact on the availability and the usability of the networking application. The network security has become one of the greatest barriers of modern networking applications.

To protect sensitive data transferred through Web, Netscape introduced the Secure Socket Layer – SSL protocol, for its Web browser. Up till now, SSL 2.0 and 3.0 has been released. SSL 2.0 is obsolete because of security problems, and it is not supported on the switches of Network.

The SSL protocol uses the public-key encryption, and has become the industry standard for secure communication on internet for Web browsing. The Web browser integrates HTTP and SSL to realize secure communication.

SSL is a safety protocol to protect private data transmission on the Internet. SSL protocols are designed for secure transmission between the client and the server, and authentication both at the server sides and optional client. SSL protocols must build on reliable transport layer (such as TCP). SSL protocols are independent for application layer. Some protocols such as HTTP, FTP, TELNET and so on, can build on SSL protocols transparently. The SSL protocol negotiates for the encryption algorithm, the encryption key and the server authentication before data is transmitted. Ever since the negotiation is done, all the data being transferred will be encrypted.

Via above introduction, the security channel is provided by SSL protocols have below three characteristics:

- ☞ Privacy. First they encrypt the suite through negotiation, then all the messages be encrypted.
- ☞ Affirmation. Though the client authentication of the conversational is optional, but the server is always authenticated.
- ☞ Reliability. The message integrity inspect is included in the sending message (use MAC).

7.9.1.1 Basic Element of SSL

The basic strategy of SSL provides a safety channel for random application data forwarding between two communication programs. In theory, SSL connect is similar with encrypt TCP connect. The position of SSL protocol is under application layer and on the TCP. If the mechanism of the data forwarding in the lower layer is reliable, the data read-in the network will be forwarded to the other program in sequence, lose packet and re-forwarding will not appear. A lot of transmission protocols can provide such kind of service in theory, but in actual application, SSL is almost running on TCP, and not running on UDP and IP directly.

When web function is running on the switch and client visit our web site through the internet browser, we can use SSL function. The communication between client and switch through SSL connect can improve the security.

Firstly, SSL should be enabled on the switch. When the client tries to access the switch through https method, a SSL session will be set up between the switch and the client. When the SSL session has been set up, all the data transmission in the application layer will be encrypted.

SSL handshake is done when the SSL session is being set up. The switch should be able to provide certification keys. Currently the keys provided by the switch are not the formal certification keys issued by official authentic, but the private certification keys generated by SSL software under Linux which may not be recognized by the web browser. With regard to the switch application, it is not necessary to apply for a formal SSL certification key. A private certification key is enough to make the communication safe between the users and the switch. Currently it is not required that the client is able to check the validation of the certification key. The encryption key and the encryption method should be negotiated during the handshake period of the session which will be then used for data encryption.

SSL session handshake process:

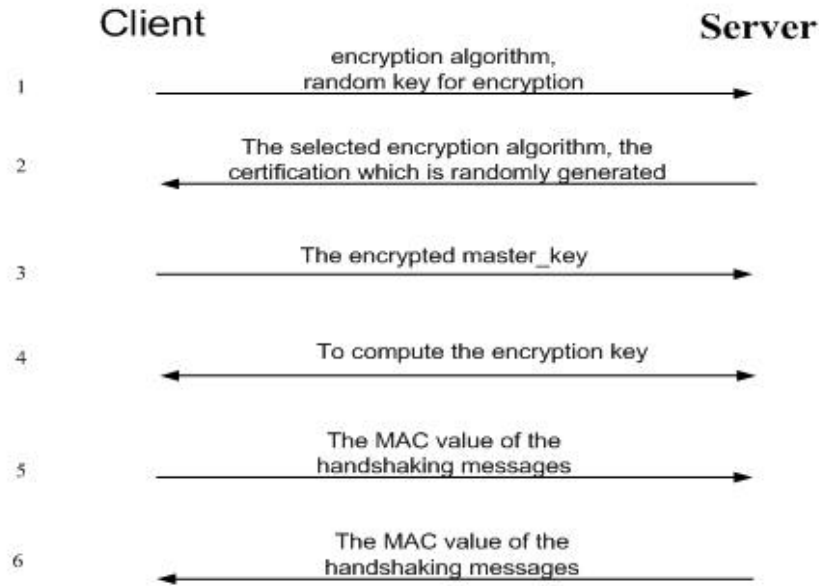

Figure 6-21 SSL session handshake process

7.9.2 SSL Configuration Task List

1. Enable/disable SSL function
2. Configure/delete port number by SSL used
3. Configure/delete secure cipher suite by SSL used
4. Maintenance and diagnose for the SSL function

1. Enable/disable SSL function

Command	Explanation
Global Mode	
ip http secure-server no ip http secure-server	Enable/disable SSL function.

2. Configure/delete port number by SSL used

Command	Explanation
Global Mode	
ip http secure-port <port-number> no ip http secure-port	Configure port number by SSL used, the“ no ip http secure-port ” command deletes the port number.

3. Configure/delete secure cipher suite by SSL used

Command	Explanation
Global Mode	
ip http secure-ciphersuite {des-cbc3-sha rc4-128-sha des-cbc-sha} no ip http secure-ciphersuite	Configure/delete secure cipher suite by SSL used.

4. Maintenance and diagnose for the SSL function

Command	Explanation

Admin Mode or Configuration Mode	
show ip http secure-server status	Show the configured SSL information.
debug ssl no debug ssl	Open/close the DEBUG for SSL function.

7.9.3 SSL Typical Example

When the Web function is enabled on the switch, SSL can be configured for users to access the web interface on the switch. If the SSL has been configured, communication between the client and the switch will be encrypted through SSL for safety.

Firstly, SSL should be enabled on the switch. When the client tries to access the switch through https method, a SSL session will be set up between the switch and the client. When the SSL session has been set up, all the data transmission in the application layer will be encrypted.

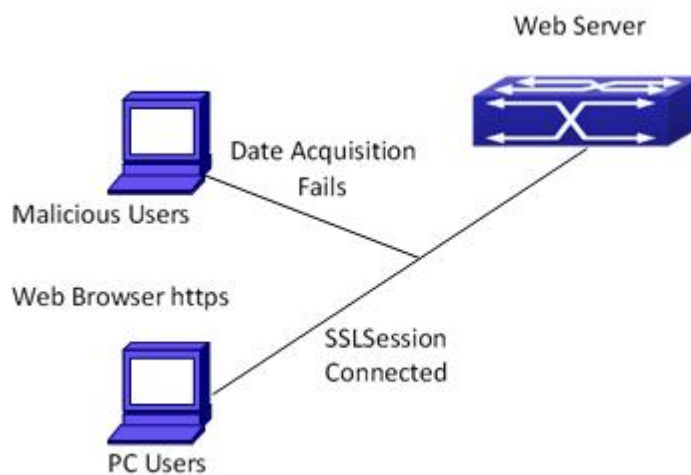

Figure 6-22

Configuration on the switch:

```
Switch(config)# ip http secure-server
Switch(config)# ip http secure-port 1025
Switch(config)# ip http secure-ciphersuite rc4-128-sha
```

7.9.4 SSL Troubleshooting

In configuring and using SSL, the SSL function may fail due to reasons such as physical connection failure or wrong configurations. The user should ensure the following:

- ☞ First good condition of the physical connection;
- ☞ Second all interface and link protocols are in the UP state (use “show interface” command);
- ☞ Then, make sure SSL function is enabled (use ip http secure-server command);
- ☞ Don't use the default port number if configured port number, pay attention to the port number when input the web wide;
- ☞ If SSL is enabled, SSL should be restarted after changes on the port configuration and

encryption configuration;

- ☞ IE 7.0 or above should be used for use of des-cbc-sha;
- ☞ If the SSL problems remain unsolved after above try, please use debug SSL and other debugging command and copy the DEBUG message within 3 minutes, send the recorded message to technical server center of our company.

7.10 VLAN-ACL

7.10.1 Introduction to VLAN-ACL

The user can configure ACL policy to VLAN to implement the accessing control of all ports in VLAN, and VLAN-ACL enables the user to expediently manage the network. The user only needs to configure ACL policy in VLAN, the corresponding ACL action can takes effect on all member ports of VLAN, but it does not need to solely configure on each member port.

When VLAN ACL and Port ACL are configured at the same time, the principle of denying firstly is used. When the packets match VLAN ACL and Port ACL at the same time, as long as one rule is drop, then the final action is drop.

Egress ACL can implement the filtering of the packets on egress and ingress direction, the packets match the specific rules can be allowed or denied. ACL can support IP ACL, MAC ACL, MAC-IP ACL, IPv6 ACL. Ingress direction of VLAN can bind four kinds of ACL at the same time, there are four resources on egress direction of VLAN, IP ACL and MAC ACL engage one resource severally, MAC-IP ACL and IPv6 ACL engage two resources severally, so egress direction of VLAN can not bind four kinds of ACL at the same time. When binding three kinds of ACL at the same time, it should be the types of IP, MAC, MAC-IP or IP, MAC, IPv6. When binding two kinds of ACL at the same time, any combination of ACL type is valid. Each type can only apply one on a VLAN.

7.10.2 VLAN-ACL Configuration Task List

1. Configure VLAN-ACL of IP type
2. Configure VLAN-ACL of MAC type
3. Configure VLAN-ACL of MAC-IP
4. Configure VLAN-ACL of IPv6 type
5. Show configuration and statistic information of VLAN-ACL
6. Clear statistic information of VLAN-ACL

1. Configure VLAN-ACL of IP type

Command	Explanation
Global mode	

vacl ip access-group {<1-299> WORD } {in out} [traffic-statistic] vlan WORD no vacl ip access-group {<1-299> WORD } {in out} vlan WORD	Configure or delete IP VLAN-ACL.
---	----------------------------------

2. Configure VLAN-ACL of MAC type

Command	Explanation
Global mode	
vacl mac access-group {<700-1199> WORD } {in out} [traffic-statistic] vlan WORD no vacl mac access-group {<700-1199> WORD } {in out} vlan WORD	Configure or delete MAC VLAN-ACL.

3. Configure VLAN-ACL of MAC-IP

Command	Explanation
Global mode	
vacl mac-ip access-group {<3100-3299> WORD } {in out} [traffic-statistic] vlan WORD no vacl mac-ip access-group {<3100-3299> WORD } {in out} vlan WORD	Configure or delete MAC-IP VLAN-ACL.

4. Configure VLAN-ACL of IPv6 type

Command	Explanation
Global mode	
vacl ipv6 access-group (<500-699> WORD) {in out} (traffic-statistic) vlan WORD no ipv6 access-group {<500-699> WORD } {in out} vlan WORD	Configure or delete IPv6 VLAN-ACL.

5. Show configuration and statistic information of VLAN-ACL

Command	Explanation
Admin mode	
show vacl [in out] vlan [<vlan-id>]	Show the configuration and the statistic information of VACL.

6. Clear statistic information of VLAN-ACL

Command	Explanation
Admin mode	
clear vacl [in out] statistic vlan [<vlan-id>]	Clear the statistic information of VACL.

7.10.3 VLAN-ACL Configuration Example

A company's network configuration is as follows, all departments are divided by different VLANs, technique department is Vlan1, finance department is Vlan2. It is required that technique department can access the outside network at timeout, but finance department are not allowed to access the outside network at any time for the security. Then the following policies are configured:

- ✎ Set the policy VACL_A for technique department. At timeout they can access the outside network, the rule as permit, but other times the rule as deny, and the policy is applied to Vlan1.
- ✎ Set the policy VACL_B of ACL for finance department. At any time they can not access the outside network, but can access the inside network with no limitation, and apply the policy to Vlan2.

Network environment is shown as below:

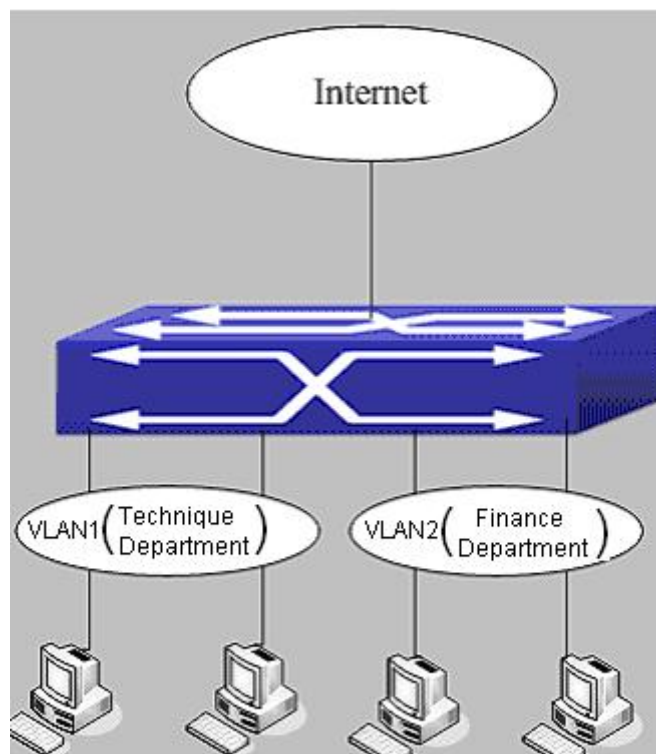

Figure 6-23 VLAN-ACL configuration example

Configuration example:

1) First, configure a timerange, the valid time is the working hours of working day:

```
Switch(config)#time-range t1
```

```
Switch(config-time-range-t1)#periodic weekdays 9:00:00 to 12:00:00
```

```
Switch(config-time-range-t1)#periodic weekdays 13:00:00 to 18:00:00
```

2) Configure the extended acl_a of IP, at working hours it only allows to access the resource within the internal network (such as 192.168.0.255).

```
Switch(config)# ip access-list extended vacl_a
```

```
Switch(config-ip-ext-nacl-vacl_a)# permit ip any-source 192.168.0.0 0.0.0.255 time-range t1
```

```
Switch(config-ip-ext-nacl-vacl_a)# deny ip any-source any-destination time-range t1
```

3) Configure the extended acl_b of IP, at any time it only allows to access resource within the internal network (such as 192.168.1.255).

```
Switch(config)#ip access-list extended vacl_b
Switch(config-ip-ext-nacl-vacl_a)# permit ip any-source 192.168.1.0 0.0.0.255
Switch(config-ip-ext-nacl-vacl_a)# deny ip any-source any-destination
4) Apply the configuration to VLAN
Switch(config)#vacl ip access-group vacl_a in vlan 1
Switch(config)#vacl ip access-group vacl_b in vlan 2
```

7.10.4 VLAN-ACL Troubleshooting

- ☞ When VLAN ACL and Port ACL are configured at the same time, the principle of denying firstly is used. When the packets match VLAN ACL and Port ACL at the same time, as long as one rule is drop, then the final action is drop.
- ☞ Each ACL of different types can only apply one on a VLAN, such as the basic IP ACL, each VLAN can applies one only.

7.11 PPPoE Intermediate Agent

7.11.1 Introduction to PPPoE Intermediate Agent

7.11.1.1 Brief Introduction to PPPoE

PPPoE (Point to Point Protocol over Ethernet) is a protocol that apply PPP protocol to Ethernet. PPP protocol is a link layer protocol and supply a communication method of point-to-point, it is usually selected by host dial-up link, for example the link is line dial-up. PPP protocol is applied to Ethernet that means PPPoE protocol makes many hosts of Ethernet to connect a remote access collector through one or multiple bridge devices. If the remote access collector is broadband access server (BAS), it can supply broadband access and accounting functions for these hosts, so PPPoE protocol is used to broadband access authentication of Ethernet usually.

7.11.1.2 Introduction to PPPoE IA

Along with broadband access technique is rapidly developed, broadband access network is also developing from strength to strength, but security problem gradually becomes the focus, soever the clients or the access device and the network are faced with security problem (especially from the client) in the current access network. Traditional Ethernet user can not be identified, traced and located exactly, however in exoteric and controllable network, identification and location are the basic character and requirement for user, for example, when supplying the

application that use user accounts to login, this method supplied by PPPoE Intermediate Agent can avoid user accounts embezzled.

There are two stages for PPPoE protocol work: discovery stage and session stage. Discovery stage is used to obtain MAC address of the remote server to establish a point-to-point link and a session ID with the server, and session stage uses this session ID to communicate. PPPoE Intermediate Agent only relates to discovery stage, so we simply introduce discovery stage.

There are four steps for discovery stage:

1. Client sends PADI packet: The first step, client uses broadcast address as destination address and broadcast PADI (PPPoE Active Discovery Initiation) packet to discover access collector in layer 2 network. Notice: This message may be sent to many access collector of the network.
2. Broadband Access Server responds PADO packet: The second step, server responds PADO (PPPoE Active Discovery Offer) packet to client according to the received source MAC address of PADI packet, the packet will take sever name and service name.
3. Client sends PADR packet: The third step, client selects a server to process the session according to the received PADO packet. It may receives many PADO packets for PADI message of the first step may be sent to many servers (select the server according to whether the service information of PADO packet match with the service information needed by client). MAC address of the other end used for session will be known after server is selected, and send PADR (PPPoE Active Discovery Request) packet to it to announce server the session requirement.
4. Server responds PADS packet: The fourth step, server establishes a session ID according to the received PADR packet, this session ID will be sent to client through PADS (PPPoE Active Discovery Session-confirmation) packet, hereto PPPoE discovery stage is completed, enter session stage.

PADT (PPPoE Active Discovery Terminate) packet is an especial packet of PPPoE, its' Ethernet protocol number (0x8863) is the same as four packets above, so it can be considered a packet of discovery stage. To stop a PPPoE session, PADT may be sent at the discretional time of the session. (It can be sent by client or server)

PPPoE Intermediate Agent supplies a function that identify and locate the user. When passing network access device, PADI and PADR messages sent by client with the access link tag of this device at PPPoE discovery stage, so as to exactly identify and locate the user on server.

If the direct-link access device is LAN switch, the added information include: MAC, Slot ID, Port Index, Vlan ID, and so on. This function is implemented according to Migration to Ethernet-based DSL aggregation.

7.11.1.2.1 PPPoE Intermediate Agent Exchange Process

PPPoE Intermediate Agent exchange process is similar to PPPoE exchange process, for the first exchange process, the access link tag is added to PADI and PADR packets. The exchange process is as follows:

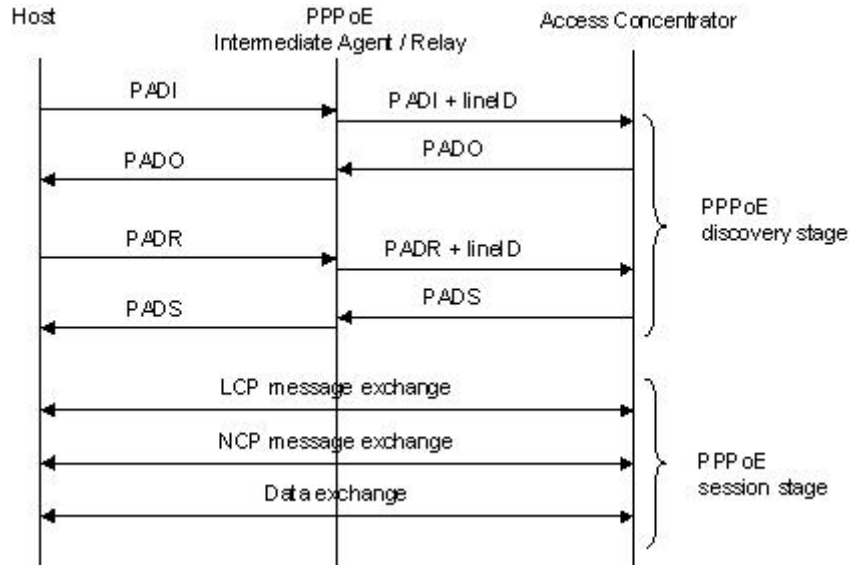

Figure 6-34 PPPoE IA protocol exchange process

7.11.1.2.2 PPPoE Packet Format

PPPoE packet format is as follows:

Ethernet II frame

Destination MAC	Source MAC	Type Field	PPPoE Data	CRC Check Sum
-----------------	------------	------------	------------	---------------

PPPoE data

Version	Type	Code	Session ID	Length Field	TLV1	TLV N
---------	------	------	------------	--------------	------	-------	-------

TLV frame

Type	Length	Data
------	--------	------

Each field meanings in the following:

Type field (2 bytes) of Ethernet II frame: The protocol sets type field value of PPPoE protocol packet as 0x8863 (include 5 kinds of packets in PPPoE discovery stage only), type field value of session stage as 0x8864.

PPPoE version field (4 bits): Specify the current PPPoE protocol version, the current version must be set as 0x1.

PPPoE type field (4 bits): Specify the protocol type, the current version must be set as 0x1.

PPPoE code field (1 byte): Specify the packet type. 0x09 means PADI packet, 0x07 means PADO packet, 0x19 means PADR packet, 0x65 means PADS packet, 0xa7 means PADT packet.

PPPoE session ID field (2 bytes): Specify the session ID.

PPPoE length field (2 bytes): Specify the sum of all TLV length.

TLV type field (2 bytes): A TLV frame means a TAG, type field means TAG type, the table is as follows.

TLV length field (2 bytes): Specify the length of TAG data field.

TLV data field (the length is not specified): Specify the transmitted data of TAG.

Tag Type	Tag Explanation
----------	-----------------

0x0000	The end of a series tag in PPPoE data field, it is saved for ensuring the version compatibility and is applied by some packets.
0x0101	Service name. Indicate the supplied services by network.
0x0102	Server name. When user receives the PADO response packet of AC, it can obtain the server name from the tag and select the corresponding server.
0x0103	Exclusive tag of the host. It is similar to tag field of PPPoE data packets and is used to match the sending and receiving end (Because broadcast network may exist many PPPoE data packets synchronously).
0x0104	AC-Cookies. It is used to avoid the vicious DOS attack.
0x0105	The identifier of vendor.
0x0110	Relay session ID. PPPoE data packet can be interrupted to other AC, this field is used to keep other connection.
0x0201	The error of service name. When the requested service name is not accepted by other end, the response packet will take this tag.
0x0202	The error of server name.
0x0203	Common error.

Table 6- 1 TAG value type of PPPoE

7.11.1.2.3 PPPoE Intermediate Agent vendor tag Frame

The following is the format of tag added by PPPoE IA, adding tag is the Uppermost function of PPPoE IA.

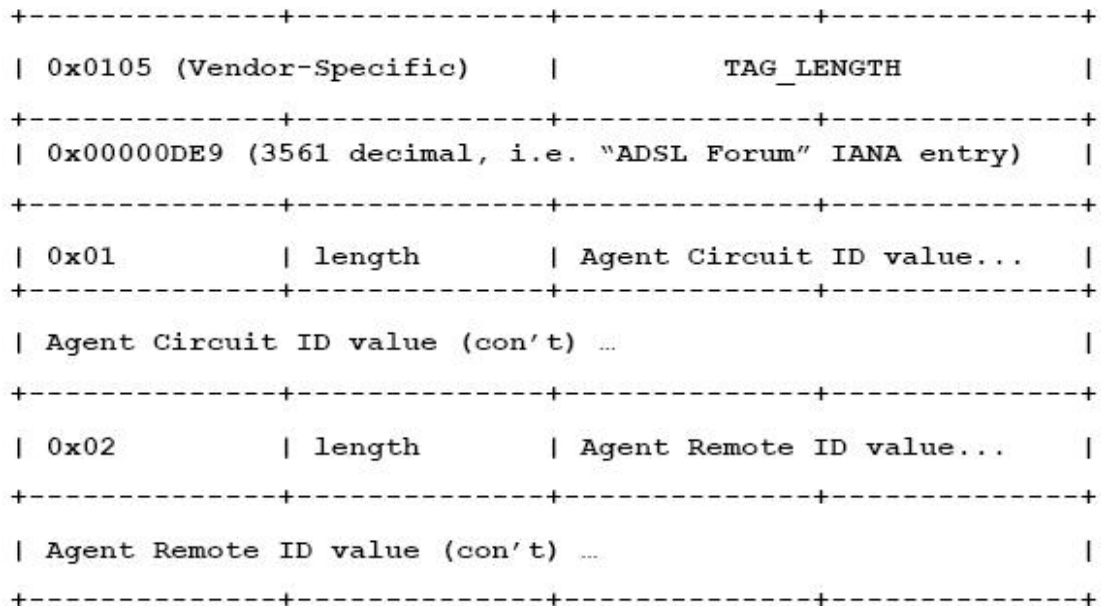

Figure 6- 35 PPPoE IA - vendor tag (4 bytes in each row)

Add TLV tag as 0x0105 for PPPoE IA, TAG_LENGTH is length field of vendor tag; 0x00000DE9 is "ADSL Forum" IANA entry of the fixed 4 bytes; 0x01 is type field of Agent Circuit ID, length is length field and Agent Circuit ID value field; 0x02 is type field of Agent Remote ID, length is length field and Agent Remote ID value field.

PPPoE IA supplies a default circuit ID value, the default circuit ID (The figure in the

following) includes 5 fields, ANI (Access Node Identifier) can be configured by user, its length is less than 47 bytes. If there is no ANI configured, MAC is accessed by default, occupy 6 bytes and use space symbol to compart, “eth” occupies 3 bytes and uses space symbol to compart, “Slot ID” occupies 2 bytes, use “/” to compart and occupy 1 byte, “Port Index” occupies 3 bytes, use “:” to compart and occupy 1 byte, “Vlan ID” occupies 4 bytes, all fields use ASCII, user can configure ciucuit ID for each port according to requirement.

ANI (n byte)	Space (1byte)	eth (3 byte)	Space (1 byte)	Slot ID (2 byte)	/ (1byte)	Port Index (3 byte)	:	Vlan ID (4 byte)
-----------------	-------------------	-----------------	-------------------	---------------------	--------------	------------------------	---	---------------------

Figure 6- 36 Agent Circuit ID value

MAC of the access switch is the default remote ID value of PPPoE IA. remote ID value can be configured by user flexibly, the length is less than 63 bytes.

7.11.1.2.4 Trust Port of PPPoE Intermediate Agent

Discovery stage sends five kinds of packets, PADI and PADR packets sent by client to server, PADO and PADS packets sent by server to client, PADT packet can be sent by server or client.

In PPPoE IA, for security and reduce traffic, set a port connected server as trust port, set ports connected client as untrust port, trust port can receive all packets, untrust port can receive only PADI, PADR and PADT packets which are sent to server. To ensure client operation is correct, it must set the port connected server as trust port, each access device has a trust port at least.

PPPoE IA vendor tag can not exist in PPPoE packets sent by server to client, so we can strip and forward these vendor tags if they exist in PPPoE packets. Strip function must be configured on trust port, enabling strip function is not take effect on untrust port.

7.11.2 PPPoE Intermediate Agent Configuration Task

List

1. Enable global PPPoE Intermediate Agent
2. Enable port PPPoE Intermediate Agent

Command	Explanation
Global Mode	
pppoe intermediate-agent no pppoe intermediate-agent	Enabel global PPPoE Intermediate Agent function.
pppoe intermediate-agent type tr-101 circuit-id access-node-id <string> no pppoe intermediate-agent type tr-101 circuit-id access-node-id	Configure access node ID field value of circuit ID in added vendor tag.
pppoe intermediate-agent type tr-101 circuit-id identifier-string <string> option {sp sv pv spv} delimiter <WORD> [delimiter <WORD>]	Configure circuit-id in added vendor tag.

<code>no pppoe intermediate-agent type tr-101 circuit-id identifier-string option delimiter</code>	
<code>pppoe intermediate-agent type self-defined circuit-id {vlan port id (switch-id (mac hostname) remote-mac) string WORD} no pppoe intermediate-agent type self-defined circuit-id</code>	Configure the self-defined circuit-id.
<code>pppoe intermediate-agent type self-defined remoteid {mac vlan-mac hostname string WORD} no pppoe intermediate-agent type self-defined remote-id</code>	Configure the self-defined remote-id.
<code>pppoe intermediate-agent delimiter <WORD> no pppoe intermediate-agent delimiter</code>	Configure the delimiter among the fields in circuit-id and remote-id
<code>pppoe intermediate-agent format (circuit-id remote-id) (hex ascii) no pppoe intermediate-agent format (circuit-id remote-id)</code>	Configure the format with hex or ASCII for circuit-id and remote-id.
Port Mode	
<code>pppoe intermediate-agent no pppoe intermediate-agent</code>	Enable PPPoE Intermediate Agent function of port.
<code>pppoe intermediate-agent vendor-tag strip no pppoe intermediate-agent vendor-tag strip</code>	Set vendor tag strip function of port.
<code>pppoe intermediate-agent trust no pppoe intermediate-agent trust</code>	Set a port as trust port.
<code>pppoe intermediate-agent circuit-id <string> no pppoe intermediate-agent circuit-id</code>	Set circuit-id of port.
<code>pppoe intermediate-agent remote-id <string> no pppoe intermediate-agent remote-id</code>	Set remote-id of port.

7.11.3 PPPoE Intermediate Agent Typical Application

PPPoE Intermediate Agent typical application is as follows:

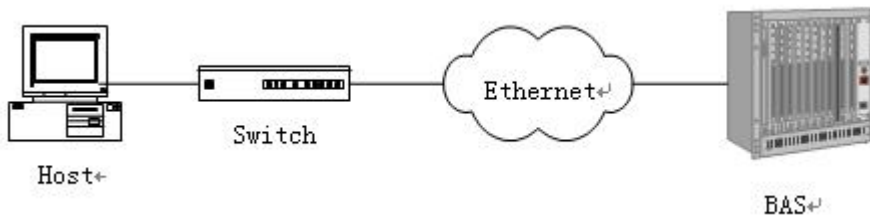

Figure 6-37 PPPoE IA typical application

Both host and BAS server run PPPoE protocol, they are connected by layer 2 ethernet, switch

enables PPPoE Intermediate Agent function.

Typical configuration (1) in the following:

Step1: Switch enables global PPPoE IA function, MAC as 0a0b0c0d0e0f.

```
Switch(config)# pppoe intermediate-agent
```

Step2: Configure port ethernet1/0/1 which connect server as trust port, and configure vendor tag strip function.

```
Switch(config-if-ethernet1/0/1)#pppoe intermediate-agent trust
```

```
Switch(config-if-ethernet1/0/1)#pppoe intermediate-agent vendor-tag strip
```

Step3: Port ethernet1/0/2 of vlan1 and port ethernet1/0/3 of vlan 1234 enable PPPoE IA function of port.

```
Switch(config-if-ethernet1/0/2)#pppoe intermediate-agent
```

```
Switch(config-if-ethernet1/0/3)#pppoe intermediate-agent
```

Step4: Configure pppoe intermediate-agent access-node-id as abcd.

```
Switch(config)#pppoe intermediate-agent type tr-101 circuit-id access-node-id abcd
```

Step5: Configure circuit ID as aaaa, remote ID as xyz for port ethernet1/0/3.

```
Switch(config-if-ethernet1/0/3)#pppoe intermediate-agent circuit-id aaaa
```

```
Switch (config-if-ethernet1/0/3)#pppoe intermediate-agent remote-id xyz
```

circuit-id value is "abcd eth 01/002:0001", remote-id value is "0a0b0c0d0e0f" for the added vendor tag of port ethernet1/0/2.

circuit-id value is "aaaa", remote-id value is "xyz" for the added vendor tag of port ethernet1/0/3.

Typical configuration (2) in the following:

Step1: Switch enables global PPPoE IA function, MAC as 0a0b0c0d0e0f.

```
Switch(config)#pppoe intermediate-agent
```

Step2: Configure port ethernet1/0/1 which connect server as trust port, and configure vendor tag strip function.

```
Switch(config-if-ethernet1/0/1)#pppoe intermediate-agent trust
```

```
Switch(config-if-ethernet1/0/1)#pppoe intermediate-agent vendor-tag strip
```

Step3: Port ethernet1/0/2 of vlan1 and port ethernet1/0/3 of vlan 1234 enable PPPoE IA function of port.

```
Switch(config-if-ethernet1/0/2)#pppoe intermediate-agent
```

```
Switch(config-if-ethernet1/0/3)#pppoe intermediate-agent
```

Step4: Configure pppoe intermediate-agent access-node-id as abcd.

```
Switch(config)#pppoe intermediate-agent type tr-101 circuit-id access-node-id abcd
```

Step5: Configure pppoe intermediate-agent identifier-string as "efgh", combo mode as spv, delimiter of Slot ID and Port ID as "#", delimiter of Port ID and Vlan ID as "/".

```
Switch(config)#pppoe intermediate-agent type tr-101 circuit-id identifier-string efgh option spv  
delimiter # delimiter /
```

Step6: Configure circuit-id value as bbbb on port ethernet1/0/2.

```
Switch(config-if-ethernet1/0/2)#pppoe intermediate-agent circuit-id bbbb
```

Step7: Configure remote-id as xyz on ethernet1/0/3.

```
Switch(config-if-ethernet1/0/3)#pppoe intermediate-agent remote-id xyz
```

circuit-id value is "bbbb", remote-id value is "0a0b0c0d0e0f" for the added vendor tag of port

ethernet1/0/2.

circuit-id value is "efgh eth 01#003/1234", remote-id value is "xyz" for the added vendor tag of port ethernet1/0/3.

7.11.4 PPPoE Intermediate Agent Troubleshooting

- ☞ Only switch enables global PPPoE intermediate agent firstly, this function can be run on port.
- ☞ Configure a trust port at least, and this port can connect to server.
- ☞ vendor tag strip function must be configured by trust port.
- ☞ Circuit-id override priority is: pppoe intermediate-agent circuit-id < pppoe intermediate-agent identifier-string option delimiter < pppoe intermediate-agent access-node-id.

7.12 QoS

7.12.1 QoS

7.12.1.1 Introduction to QoS

QoS (Quality of Service) is a set of capabilities that allow you to create differentiated services for network traffic, thereby providing better service for selected network traffic. QoS is a guarantee for service quality of consistent and predictable data transfer service to fulfill program requirements. QoS cannot generate extra bandwidth but provides more effective bandwidth management according to the application requirement and network management policy.

7.12.1.1.1 QoS Terms

QoS: Quality of Service, provides a guarantee for service quality of consistent and predictable data transfer service to fulfill program requirements. QoS cannot generate new bandwidth but provides more effective bandwidth management according to the application requirement and network management.

QoS Domain: QoS Domain supports QoS devices to form a net-topology that provides Quality of Service, so this topology is defined as QoS Domain.

CoS: Class of Service, the classification information carried by Layer 2 802.1Q frames, taking 3 bits of the Tag field in frame header, is called user priority level in the range of 0 to 7.

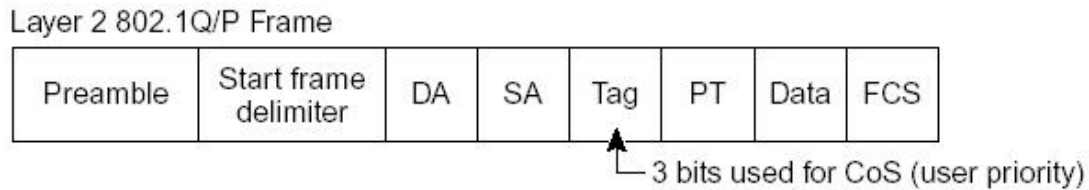

Figure 6-383 CoS priority

ToS: Type of Service, a one-byte field carried in Layer 3 IPv4 packet header to symbolize the service type of IP packets. Among ToS field can be IP Precedence value or DSCP value.

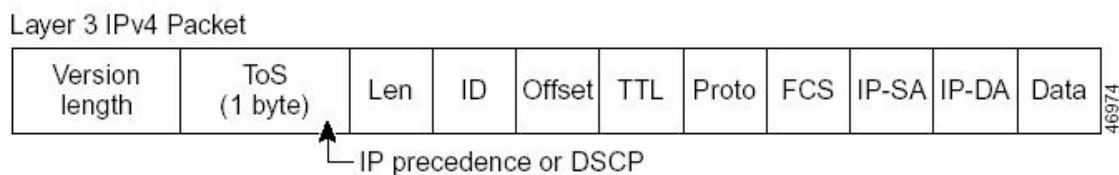

Figure 6-34 ToS priority

IP Precedence: IP priority. Classification information carried in Layer 3 IP packet header, occupying 3 bits, in the range of 0 to 7.

DSCP: Differentiated Services Code Point, classification information carried in Layer 3 IP packet header, occupying 6 bits, in the range of 0 to 63, and is downward compatible with IP Precedence.

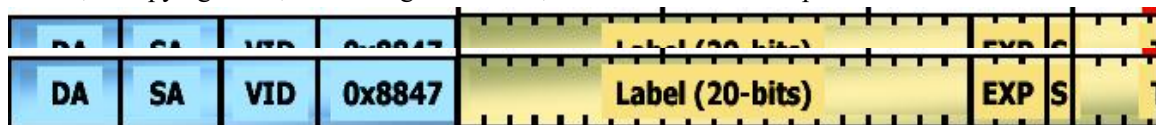

Figure 6-35

A field of the MPLS packets means the service class, there are 3 bits, the ranging from 0 to 7.

Internal Priority: The internal priority setting of the switch chip, it's valid range relates with the chip, it's shortening is Int-Prio or IntP.

Drop Precedence: When processing the packets, firstly drop the packets with the bigger drop precedence, the ranging is the ranging is 0-2 in three color algorithm, the ranging is 0-1 in dual color algorithm. It's shortening is Drop-Prec or DP.

Classification: The entry action of QoS, classifying packet traffic according to the classification information carried in the packet and ACLs.

Policing: Ingress action of QoS that lays down the policing policy and manages the classified packets.

Remark: Ingress action of QoS, perform allowing, degrading or discarding operations to packets according to the policing policies.

Scheduling: QoS egress action. Configure the weight for eight egress queues WRR (Weighted Round Robin).

In-Profile: Traffic within the QoS policing policy range (bandwidth or burst value) is called In-Profile.

Out-of-Profile: Traffic out the QoS policing policy range (bandwidth or burst value) is called Out-of-Profile.

7.12.1.1.2 QoS Implementation

To implement the switch software QoS, a general, mature reference model should be given. QoS can not create new bandwidth, but can maximize the adjustment and configuration for the current bandwidth resource. Fully implemented QoS can achieve complete management over the network traffic. The following is as accurate as possible a description of QoS.

The data transfer specifications of IP cover only addresses and services of source and destination, and ensure correct packet transmission using OSI layer 4 or above protocols such as TCP. However, rather than provide a mechanism for providing and protecting packet transmission bandwidth, IP provide bandwidth service by the best effort. This is acceptable for services like Mail and FTP, but for increasing multimedia business data and e-business data transmission, this best effort method cannot satisfy the bandwidth and low-lag requirement.

Based on differentiated service, QoS specifies a priority for each packet at the ingress. The classification information is carried in Layer 3 IP packet header or Layer 2 802.1Q frame header. QoS provides same service to packets of the same priority, while offers different operations for packets of different priority. QoS-enabled switch or router can provide different bandwidth according to the packet classification information, and can remark on the classification information according to the policing policies configured, and may discard some low priority packets in case of bandwidth shortage.

If devices of each hop in a network support differentiated service, an end-to-end QoS solution can be created. QoS configuration is flexible, the complexity or simplicity depends on the network topology and devices and analysis to incoming/outgoing traffic.

7.12.1.1.3 Basic QoS Model

The basic QoS consists of four parts: Classification, Policing, Remark and Scheduling, where classification, policing and remark are sequential ingress actions, and Queuing and Scheduling are QoS egress actions.

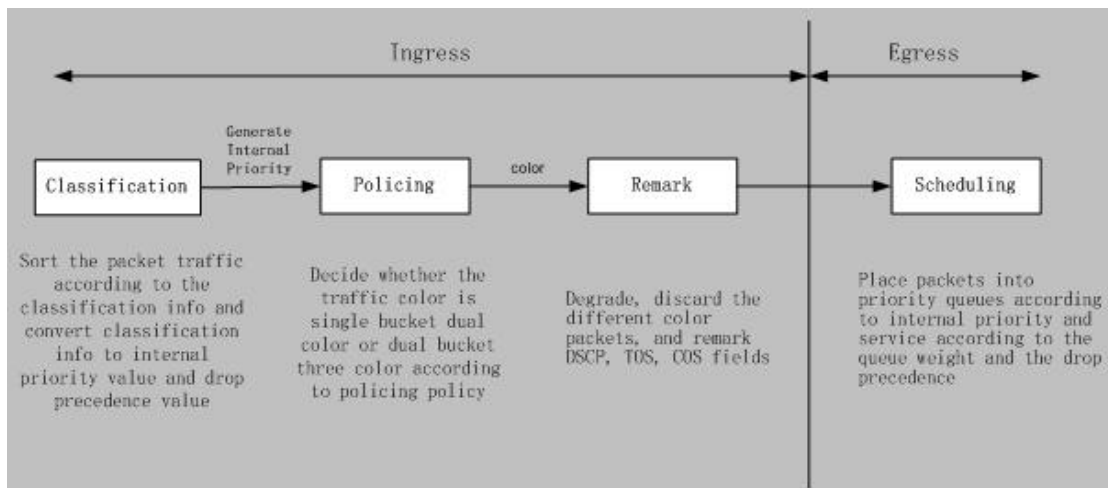

Figure 6-36 Basic QoS Model

Classification: Classify traffic according to packet classification information and generate internal priority and drop precedence based the classification information. For different packet types and switch configurations, classification is performed differently; the flowchart below explains this in detail.

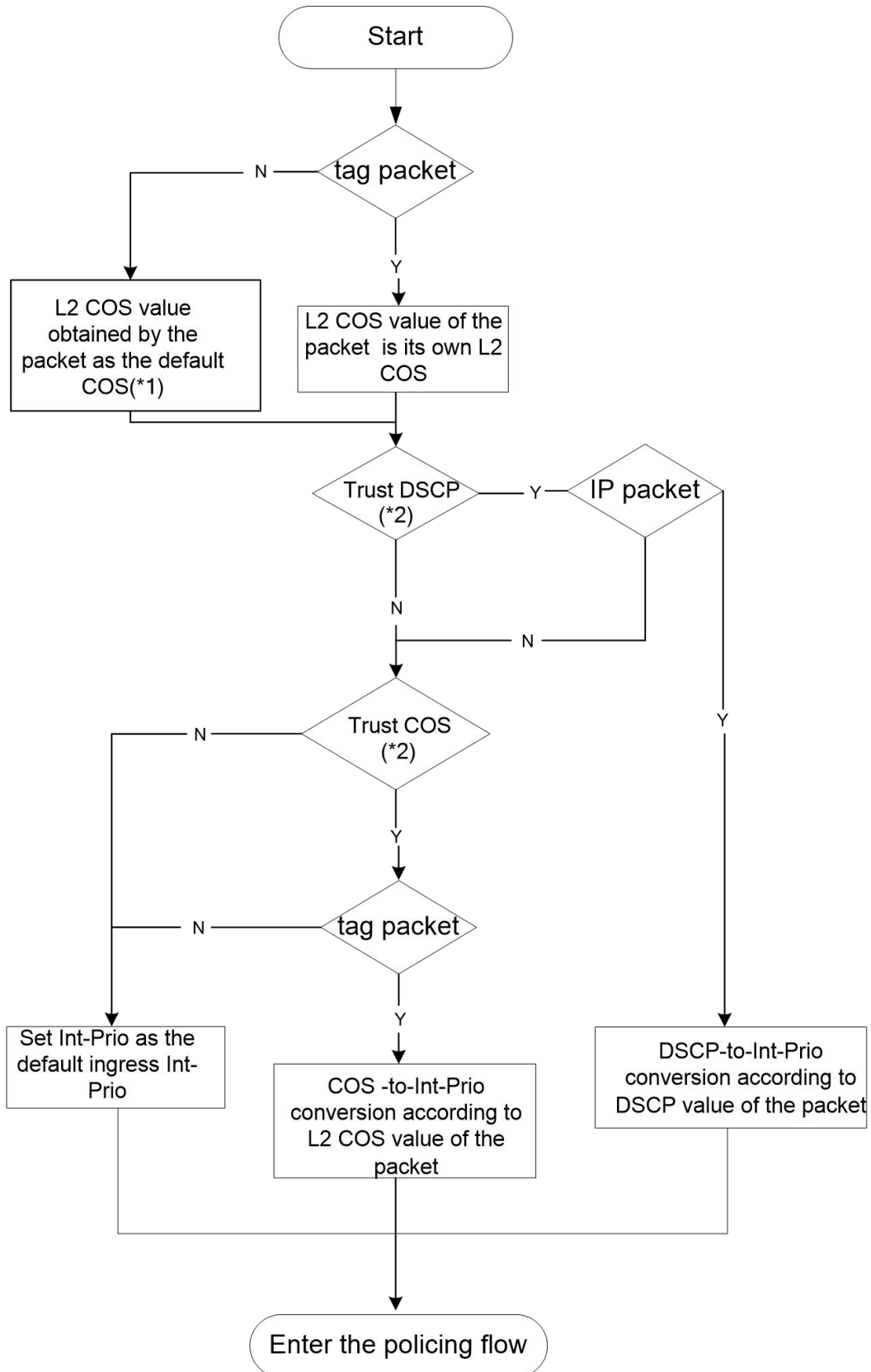

Figure 6-37 Classification process

Policing and remark: Each packet in classified ingress traffic is assigned an internal priority value and a drop precedence value, and can be policed and remarked.

Policing can be performed based on the flow to configure different policies that allocate bandwidth to classified traffic, the assigned bandwidth policy may be dual bucket dual color or dual bucket three color. The traffic, will be assigned with different color, can be discarded or passed, for the passed packets, add the remarking action. Remarketing uses a new DSCP value of lower priority to replace the original higher level DSCP value in the packet. The following flowchart describes the operations.

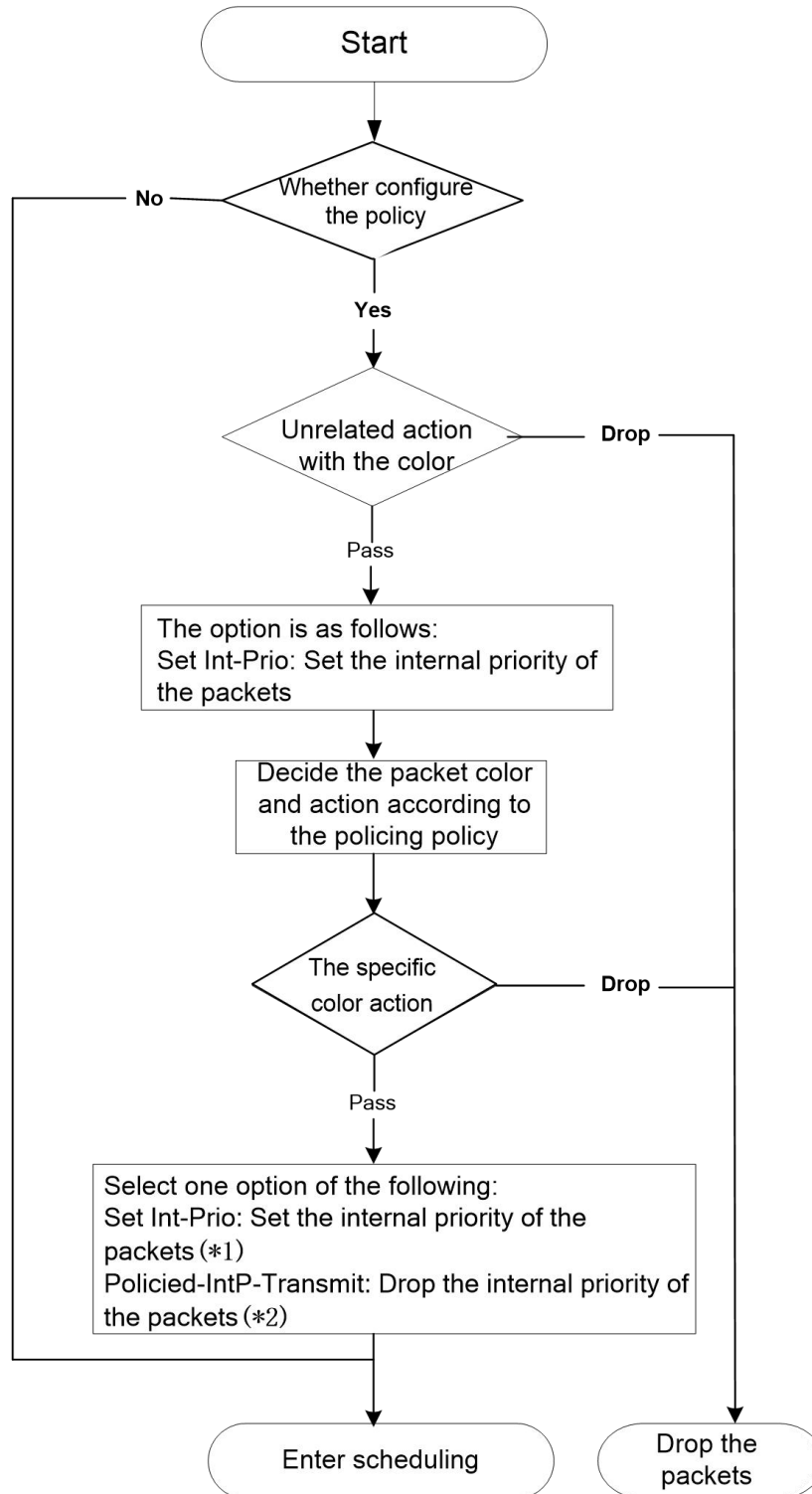

Figure 6-38 Policing and Remarking process

Queuing and scheduling: There are the internal priority and the drop precedence for the egress packets, the queuing operation assigns the packets to different priority queues according to the internal priority, while the scheduling operation perform the packet forwarding according to the priority queue weight and the drop precedence. The following flowchart describes the operations during queuing and scheduling.

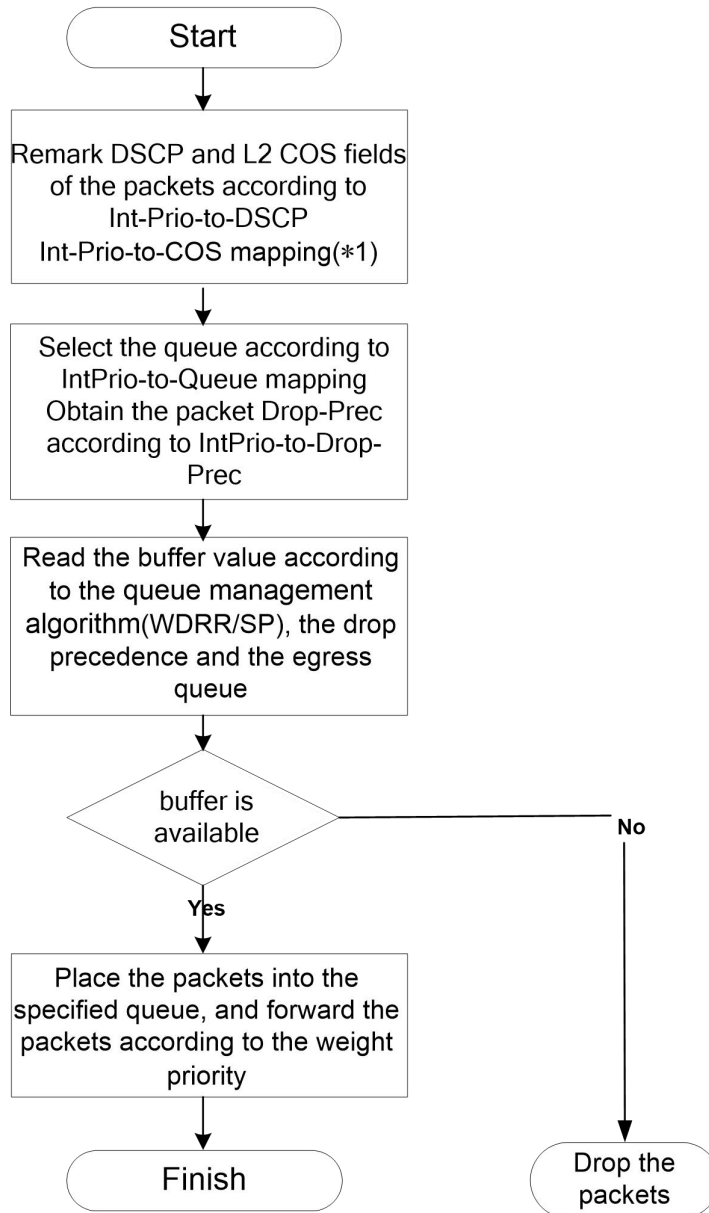

Figure 6-39 Queuing and Scheduling process

7.12.1.2 QoS Configuration Task List

Configure class map

Set up a classification rule according to ACL, CoS, VLAN ID, IPv4 Precedent, DSCP, IPV6 FL to classify the data stream. Different classes of data streams will be processed with different policies.

Configure a policy map

After data steam classification, a policy map can be created to associate with the class map created earlier and enter class mode. Then different policies (such as bandwidth limit, priority degrading assigning new DSCP value) can be applied to different data streams. You can also define a policy set that can be use in a policy map by several classes.

Apply QoS to the ports or the VLAN interfaces

Configure the trust mode for ports or bind policies to ports. A policy will only take effect on a port when it is bound to that port.

Apply QoS to the ports or the VLAN interfaces

Configure the trust mode for ports or bind policies to ports. A policy will only take effect on a port when it is bound to that port.

The policy may be bound to the specific VLAN, it also supports to modify dynamically.

It is not recommended to synchronously use policy map on VLAN and its port.

Configure queue management algorithm

Configure queue management algorithm, such as sp, wrr, wdr, and so on.

Configure QoS mapping

Configure the mapping from CoS to DP, DSCP to DSCP, IntP or DP, IntP to DSCP.

1. Configure class map.

Command	Explanation
Global Mode	
class-map <class-map-name> no class-map <class-map-name>	Create a class map and enter class map mode; the “no class-map <class-map-name> ” command deletes the specified class map.
match {access-group <acl-index-or-name> ip dscp <dscp-list> ip precedence <ip-precedence-list> ipv6 access-group <acl-index-or-name> ipv6 dscp <dscp-list> ipv6 flowlabel <flowlabel-list> vlan <vlan-list> cos <cos-list> exp <exp-list>} no match {access-group ip dscp ip precedence ipv6 access-group ipv6 dscp ipv6 flowlabel vlan cos exp}	Set matching criterion (classify data stream by ACL, CoS, VLAN ID, IPv4 Precedent, IPv6 FL or DSCP, etc) for the class map; the no command deletes specified matching criterion.

2. Configure a policy map

Command	Explanation
Global Mode	
policy-map <policy-map-name> no policy-map <policy-map-name>	Create a policy map and enter policy map mode; the no command deletes the specified policy map.
class <class-map-name> [insert-before <class-map-name>] no class <class-map-name>	After a policy map is created, it can be associated to a class. Different policy or new DSCP value can be applied to different data streams in class mode; the

	no command deletes the specified class.
set {ip dscp <new-dscp> ip precedence <new-precedence> internal priority <new-inp> drop precedence <new-dp> cos <new-cos>} no set {ip dscp ip precedence internal priority drop precedence cos }K	Assign a new DSCP, CoS, IP Precedence value for the classified traffic; the no command cancels the newly assigned value.
Single bucket mode: policy <bits_per_second> <normal_burst_bytes> ({conform-action ACTION exceed-action ACTION}) Dual bucket mode: policy <bits_per_second> <normal_burst_bytes> [pir <peak_rate_bps>] <maximum_burst_bytes> [{conform-action ACTION exceed-action ACTION violate-action ACTION }] ACTION definition: drop transmit set-dscp-transmit <dscp_value> set-prec-transmit <ip_precedence_value> set-cos-transmit <cos_value> set-internal-priority <inp_value> set-Drop-Precedence <dp_value> no policy	Configure a policy for the classified flow. The non-aggregation policy command supports three colors. Analyze the working mode of the token bucket, whether it is single rate single bucket, single rate dual bucket, dual rate dual bucket, set corresponding action to different color packets. The no command will delete the mode configuration. Single bucket mode is supported by the specific switch.
policy aggregate <aggregate-policy-name> no policy aggregate <aggregate-policy-name>	Apply a policy to classified traffic; the no command deletes the specified policy set.
accounting no accounting	Set statistic function for the classified traffic. After enable this function under the policy class map mode, add statistic function to the traffic of the policy class map. In single bucket mode, the messages can only red or green when passing policy. In the print information, in-profile means green and out-profile means red. In dual bucket mode, there are three colors of the packets. In the print information, in-profile means green and out-profile means red and yellow.
Policy class map configuration mode	
drop no drop transmit no transmit	Drop or transmit data package that match the class, the no command cancels the assigned action.

3. Apply QoS to port or VLAN interface

Command	Explanation
Interface Configuration Mode	
mls qos trust dscp no mls qos trust dscp	Configure port trust; the no command disables the current trust status of the port.
mls qos cos {<default-cos>} no mls qos cos	Configure the default CoS value of the port; the no command restores the default setting.
service-policy input <policy-map-name> no service-policy input {<policy-map-name>}	Apply a policy map to the specified port; the no command deletes the specified policy map applied to the port. Egress policy map is not supported yet or deletes all the policy maps applied on the ingress direction of the port
Global Mode	
service-policy input <policy-map-name> vlan <vlan-list> no service-policy input {<policy-map-name>} vlan <vlan-list>	Apply a policy map to the specified VLAN interface; the no command deletes the specified policy map applied to the VLAN interface or deletes all the policy maps applied in the ingress direction of the vlan interface .

4. Configure queue management algorithm and weight

Command	Explanation
Port Configuration Mode	
mls qos queue algorithm {sp wrr wdr} no mls qos queue algorithm	Set queue management algorithm, the default queue management algorithm is wrr.
mls qos queue wrr weight <weight0..weight7> no mls qos queue wrr weight	Set queue weight based a port, the default queue weight is 1 2 3 4 5 6 7 8.
mls qos queue wdr weight <weight0..weight7> no mls qos queue wdr weight	Set queue weight based a port, the default queue weight is 10 20 40 80 160 320 640 1280.
mls qos queue <queue-id> bandwidth <minimum-bandwidth> <maximum-bandwidth> no mls qos queue <queue-id> bandwidth	Set bandwidth guarantee based a port.

5. Configure QoS mapping

Command	Explanation
---------	-------------

Global Mode	
<pre>mls qos map (cos-dp <dp1...dp8> cos-intp <in-cos list > dscp-dscp <in-dscp list> to <out-dscp> dscp-intp <in-dscp list> to <intp> dscp-dp <in-dscp list> to <dp> intp-exp <exp1...exp8>) no mls qos map (cos-dp dscp-dscp dscp-intp dscp-dp) mls qos map intp-exp <exp1...exp8> no mls qos map intp-exp</pre>	Set the priority mapping for QoS, the no command restores the default mapping value.

6. Clear accounting data of the specific ports or VLANs

Command	Explanation
Admin Mode	
<pre>clear mls qos statistics [in out] {interface <interface-name> vlan <vlan-id>}</pre>	Clear the in or out directions accounting data of the specified ports or VLAN Policy Map.

7. Show configuration of QoS

Command	Explanation
Admin Mode	
<pre>show mls qos maps [cos-dp cos-intp dscp-dscp dscp-intp dscp-dp intp-exp]</pre>	Display the configuration of QoS mapping.
<pre>show class-map [<class-map-name>]</pre>	Display the classified map information of QoS.
<pre>show policy-map [<policy-map-name>]</pre>	Display the policy map information of QoS.
<pre>show mls qos {interface [<interface-id>] [policy queuing] vlan <vlan-id>}</pre>	Display QoS configuration information on a port.
<pre>show mls qos in {interface <interface-name> policy vlan <vlan-id>}</pre>	Show the policy configuration information of the port or vlan of in direction.
<pre>show mls qos interface <interface-id> wred [queue <queue-id>] [dp<dp>]</pre>	Show the wred parameter corresponding to dp value of the appointed queue under the port.
Show mls qos vlan	Show the qos information of VLAN interface.
<pre>show mls qos aggregate-policy [policy-name]</pre>	Show the configuration information of aggregate-policy.

7.12.1.3 QoS Example

Example 1:

Enable QoS function, change the queue out weight of port ethernet 1/0/1 to 1:1:2:2:4:4:8:8, set the port in trust CoS mode without changing DSCP value, and set the default CoS value of the port to 5.

The configuration steps are listed below:

```
Switch#config
Switch(config)#interface ethernet 1/0/1
Switch(Config-If-Ethernet1/0/1)# mls qos queue wrr weight 1 1 2 2 4 4 8 8
Switch(Config-If-Ethernet1/0/1)#mls qos cos 5
```

Configuration result:

When QoS enabled in Global Mode, the egress queue bandwidth proportion of port ethernet1/0/1 is 1:1:2:2:4:4:8:8. When packets have CoS value coming in through port ethernet1/0/1, it will be map to the queue out according to the CoS value, CoS value 0 to 7 correspond to queue out 1, 2, 3, 4, 5, 6, 7, 8 respectively. If the incoming packet has no CoS value, it is default to 5 and will be put in queue6. All passing packets would not have their DSCP values changed.

Example 2:

In port ethernet1/0/2, set the bandwidth for packets from segment 192.168.1.0 to 10 Mb/s, with a burst value of 4 MB, all packets exceed this bandwidth setting will be dropped.

The configuration steps are listed below:

```
Switch#config
Switch(config)#access-list 1 permit 192.168.1.0 0.0.0.255
Switch(config)#class-map c1
Switch(Config-ClassMap-c1)#match access-group 1
Switch(Config-ClassMap-c1)#exit
Switch(config)#policy-map p1
Switch(Config-PolicyMap-p1)#class c1
Switch(Config-PolicyMap-p1-Class-c1)#policy 10000 4000 exceed-action drop
Switch(Config-PolicyMap-p1-Class-c1)#exit
Switch(Config-PolicyMap-p1)#exit
Switch(config)#interface ethernet 1/0/2
Switch(Config-If-Ethernet1/0/2)#service-policy input p1
```

Configuration result:

An ACL name 1 is set to matching segment 192.168.1.0. Enable QoS globally, create a class map named c1, matching ACL1 in class map; create another policy map named p1 and refer to c1 in p1, set appropriate policies to limit bandwidth and burst value. Apply this policy map on port ethernet1/0/2. After the above settings done, bandwidth for packets from segment 192.168.1.0 through port ethernet 1/0/2 is set to 10 Mb/s, with a burst value of 4 MB, all packets exceed this

bandwidth setting in that segment will be dropped.

Example 3:

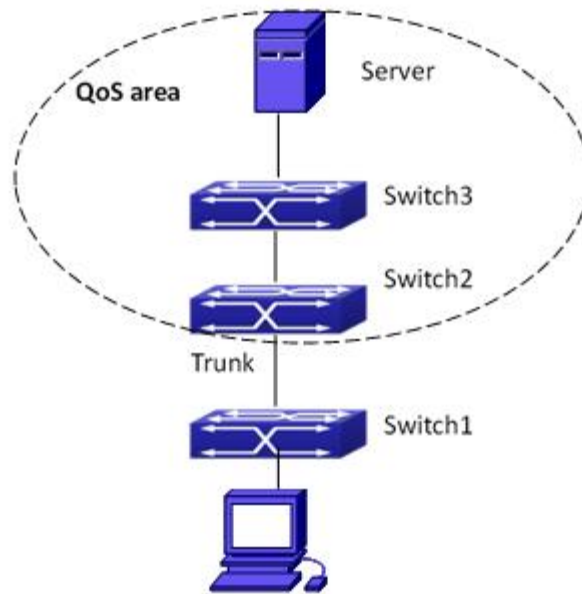

Figure 6-390 Typical QoS topology

As shown in the figure, inside the block is a QoS domain, Switch1 classifies different traffics and assigns different IP precedences. For example, set CoS precedence for packets from segment 192.168.1.0 to 5 on port ethernet1/0/1. The port connecting to switch2 is a trunk port. In Switch2, set port ethernet 1/0/1 that connecting to switch1 to trust cos. Thus inside the QoS domain, packets of different priorities will go to different queues and get different bandwidth.

The configuration steps are listed below:

QoS configuration in Switch1:

```
Switch#config
```

```
Switch(config)#access-list 1 permit 192.168.1.0 0.0.0.255
```

```
Switch(config)#class-map c1
```

```
Switch(Config-ClassMap-c1)#match access-group 1
```

```
Switch(Config-ClassMap-c1)#exit
```

```
Switch(config)#policy-map p1
```

```
Switch(Config-PolicyMap-p1)#class c1
```

```
Switch(Config-PolicyMap-p1-Class-c1)#set ip precedence 5
```

```
Switch(Config-PolicyMap-p1-Class-c1)#exit
```

```
Switch(Config-PolicyMap-p1)#exit
```

```
Switch(config)#interface ethernet 1/0/1
```

```
Switch(Config-If-Ethernet1/0/1)#service-policy input p1
```

QoS configuration in Switch2:

```
Switch#config
```

```
Switch(config)#interface ethernet 1/0/1
```

7.12.1.4 QoS Troubleshooting

trust cos and exp can be used with other trust or Policy Map.

- ☞ trust dscp can be used with other trust or Policy Map. This configuration takes effect to IPv4 and IPv6 packets.
- ☞ trust exp, trust dscp and trust cos may be configured at the same time, the priority is: EXP>DSCP>COS.
- ☞ If the dynamic VLAN (mac vlan/voice vlan/ip subnet vlan/protocol vlan) is configured, then the packet COS value equals COS value of the dynamic VLAN.
- ☞ Policy map can only be bound to ingress direction, egress is not supported yet.
- ☞ At present, it is not recommended to synchronously use policy map on VLAN and VLAN's port.
- ☞

7.12.2 PBR

7.12.2.1 Introduction to PBR

PBR (Policy-Based Routing) is a method which determines the next-hop of the data packets by policy messages such as source address, destination address, IP priority, TOS value, IP protocol, source port No, destination port No, etc.

7.12.2.2 PBR Configuration

1. Configure a class-map
2. Set match standard of the class-map
3. Configure a policy-map
4. Configure a policy map corresponding to a class map
5. Configure nexthop IPv4 address
6. Configure the port binding policy map
7. Configure the VLAN binding policy map

1. Configure a class-map

Command	Explanation
Global Configuration Mode	
class-map <class-map-name> no class-map <class-map-name>	Set up or delete a class-map.

2. Set match standard of the class-map

Command	Explanation
Class-map Configuration Mode	
match ip {access-group <acl-index-or-name>} no match ip {access-group}	Set the match standard of the class-map

3. Configure a policy-map

Command	Explanation
Global Configuration Mode	
policy-map <policy-map-name> no policy-map <policy-map-name>	Set up or delete a policy-map.

4. Configure a policy map corresponding to a class map

Command	Explanation
Policy-map Configuration Mode	
class <class-map-name> no class <class-map-name>	Correspond a class-map, and enter the policy map mode.

5. Configure nexthop IPv4 address

Command	Explanation
Policy-class-map Mode	
set ipv4 [default] nexthop [vrf <vrf>] <nexthop-ip> no set ipv4 nexthop	Set nexthop IP for the classified traffic, the no command cancels the new assigned value.

6. Configure the port binding policy map

Command	Explanation
Port Mode	
service-policy {input <policy-map-name> output <policy-map-name>} no service-policy {input <policy-map-name> output <policy-map-name>}	Apply a policy map to the specified port. Only one policy map can be applied to each direction of each port. Egress policy map is not supported yet.

7. Configure the VLAN binding policy map

Command	Explanation
Global Configuration Mode	
service-policy input <policy-map-name> vlan <vlan-list> no service-policy input <policy-map-name> vlan <vlan-list>	Apply a policy map to the specified VLAN interface; the no command deletes the specified policy map applied to the VLAN interface.

7.12.2.3 PBR Examples

Example:

On port ethernet1/0/1, apply policy-based routing on packages from 192.168.1.0/24 segment, and set the next-hop as 218.31.1.119, meanwhile the local network IP of this network ranges within 192.168.0.0/16. To assure normal communication in local network, messages from 192.168.1.0/24 to local IP 192.168.0.0/16 are not applied with policy routing. The interface address of 192.168.1.0/24 of this device is 192.168.1.1.

Configuration procedure is as follows:

```
Switch#config
Switch(config)#ip access-list extended a1
Switch(Config-IP-Ext-Nacl-a1)# permit ip 192.168.1.0 0.0.0.255 192.168.0.0 0.0.255.255
Switch(Config-IP-Ext-Nacl-a1)#exit
Switch(config)#ip access-list extended a2
Switch(Config-IP-Ext-Nacl-a1)# permit ip 192.168.1.0 0.0.0.255 any-destination
Switch(Config-IP-Ext-Nacl-a1)#exit
Switch(config)#mls qos
Switch(config)#class-map c1
Switch(Config-ClassMap-c1)#match access-group a1
Switch(Config-ClassMap-c1)# exit
Switch(config)#class-map c2
Switch(Config-ClassMap-c2)#match access-group a2
Switch(Config-ClassMap-c2)# exit
Switch(config)#policy-map p1
Switch(Config-PolicyMap-p1)#class c1
Switch(Config-PolicyMap-p1-Class-c1)#set ip nexthop 192.168.1.1
Switch(Config-PolicyMap-p1-Class-c1)#exit
Switch(Config-PolicyMap-p1)#class c2
Switch(Config-PolicyMap-p1-Class-c2)#set ip nexthop 218.31.1.119
Switch(Config-PolicyMap-p1-Class-c2)#exit
Switch(config)#interface ethernet 1/0/1
Switch(Config-If-Ethernet1/0/1)#service-policy input p1
```

Configuration results:

First set ACL a1 and a2. a1 matches source IP segments 192.168.1.0/24 and destination IP segments 192.168.0.0/16. a2 matches source IP segments 192.168.1.0/24. Turn on QoS function in global mode and create two class-maps: c1 in which matches ACL a1 and c2 in which matches ACL a2. And create a policy-map in which quote c1. Set the interface address of 192.168.1.0/24 of this device as 192.168.1.1. Set the next-hop IP as 218.31.1.119 and apply the policy-map at port ethernet1/0/1. After that, all messages on port ethernet 1/0/1 from segment 192.168.1.0/24 will be transmitted through 218.31.1.119 except those from 192.168.0.0/16 segment which are still be

transmitted through normal L3 routing.

7.12.3 IPv6 PBR

7.12.3.1 Introduction to PBR (Policy-based Router)

Policy-based routing provides a more powerful control over the forwarding and store of messages than traditional routing protocol to network managers. Traditionally, routers use the routing table derived from router protocol, and forward according to destination addresses. The policy-based router is more powerful and more flexible than the traditional one, because it enables network managers to choose the forwarding route not only according to destination addresses but also the size of messages, or source IP addresses. Policy can be defined as according to the balance of load in multiple routers or according to the quality of service (QOS) of the total flow forwarded in each line.

PBR (Policy-Based Routing) is a method which politically specifies the next hop when forwarding a data packet according to the source address, destination address, IP priority, TOS value, IP protocol, source port, destination port and other information of an IP packet.

7.12.3.2 PBR Configuration Task Sequence

1. Configure a class-map
2. Set the match standard in the class-map
3. Configure a policy-map
4. Configure to correlate a policy and a class-map
5. Configure the next hop IPv6 address
6. Configure the port binding policy map
7. Configure the VLAN binding policy map

1. Configure a class-map

Command	Explanation
Global Configuration Mode	
class-map <class-map-name> no class-map <class-map-name>	Create or delete a class-map.

2. Set the match standard in the class-map

Command	Explanation
Class-map Mode	
match ipv6 {access-group <acl-index-or-name>} no match ipv6 {access-group }	Set the match standard in the class-map.

3. Configure a policy-map

Command	Explanation
Global Configuration Mode	
policy-map <policy-map-name> no policy-map <policy-map-name>	Create or delete a policy-map.

4. Configure to correlate a policy and a class-map

Command	Explanation
Policy-map Mode	
class <class-map-name> no class <class-map-name>	Correlate with a class, and enter the policy-map mode.

5. Configure the next hop IPv6 address

Command	Explanation
Policy-class-map Mode	
set ipv6 [default] nexthop [vrf <vrf>] <nexthop-ip> no set ipv6 nexthop	Set the next hop IP for the classified flow, the no command cancels the new assigned value.

6. Configure the port binding policy-map

Command	Explanation
Port Configuration Mode	
service-policy {input <policy-map-name> output <policy-map-name>} no service-policy {input <policy-map-name> output <policy-map-name>}	Apply a policy map to the specified port. Only one policy map can be applied to each direction of each port. Egress policy map is not supported yet.

7. Configure the VLAN binding policy map

Command	Explanation
Global Mode	
service-policy input <policy-map-name> vlan <vlan-list> no service-policy input <policy-map-name> vlan <vlan-list >	Apply a policy map to the specified VLAN interface; the no command deletes the specified policy map applied to the VLAN interface.

7.12.3.3 PBR Examples

Example:

On port ethernet 1/0/1, the default gateway address of this device is 3000::1, set the messages whose source IP is within the segment 2000:: /64 to do policy routing, the next hop is 3100::2.

The following is the configuration steps:

```
Switch#config
Switch(config)#interface vlan 1
Switch(Config-if-Vlan1)#ipv6 address 2000::1/64
Switch(Config-if-Vlan1)#ipv6 neighbor 2000::2 00-00-00-00-00-01 interface Ethernet 1/0/1
Switch(config)#interface vlan 2
Switch(Config-if-Vlan2)#ipv6 address 3000::1/64
Switch(Config-if-Vlan2)#ipv6 neighbor 3000::2 00-00-00-00-00-02 interface Ethernet 1/0/2
Switch(config)#interface vlan 3
Switch(Config-if-Vlan3)#ipv6 address 3100::1/64
Switch(Config-if-Vlan3)#ipv6 neighbor 3100::2 00-00-00-00-00-03 interface Ethernet 1/0/5
Switch(config)# ipv6 access-list extended b1
Switch(Config-IPv6-Ext-Nacl-b1)# permit 2000:: /64 any-destination
Switch(Config-IPv6-Ext-Nacl-b1)#exit
Switch(config)#class-map c1
Switch(config-ClassMap)#match ipv6 access-group b1
Switch(config-ClassMap)# exit
Switch(config)#policy-map p1
Switch(config-PolicyMap)#class c1
Switch(config-Policy-Class)# set ipv6 nexthop 3100::2
Switch(config--Policy-Class)#exit
Switch(config-PolicyMap)#exit
Switch(config)#interface ethernet 1/0/1
Switch(Config-Ethernet1/0/1)#service-policy input p1
```

Configuration result:

First, set an ACL containing one entry, names it as b1, matching source IP segment 2000::/64(permit). Globally enable QoS function, create a class-map:c1, and match ACL b1 in the class-map. Create a policy-map:p1, quoting c1 in p1, and set the next hop as 3100::2. Apply this policy-map on port ethernet 1/0/1. After that, the messages whose source IP are within the segment 2000::/64 received on port ethernet 1/0/1 will be forwarded through 3100::2.

7.12.3.4 PBR Troubleshooting Help

- ✎ At present, policy-map can only be bound to input port but not output port.
- ✎ Since hardware resources are limited, if the policy is too complicated to configure, relative information will be noticed to users.

7.13 Flow-based Redirection

7.13.1 Introduction to Flow-based Redirection

Flow-based redirection function enables the switch to transmit the data frames meeting some special condition (specified by ACL) to another specified port. The frames meeting a same special condition are called a class of flow, the ingress port of the data frame is called the source port of redirection, and the specified egress port is called the destination port of redirection. Usually there are two kinds of application of flow-based redirection: 1. connecting a protocol analyzer (for example, Sniffer) or a RMON monitor to the destination port of redirection, to monitor and manage the network, and diagnose the problems in the network; 2. Special transmission policy for a special type of data frames.

The switch can only designate a single destination port of redirection for a same class of flow within a source port of redirection, while it can designate different destination ports of redirection for different classes of flows within a source port of redirection. The same class of flow can be applied to different source ports.

7.13.2 Flow-based Redirection Configuration Task

Sequence

- 1.Flow-based redirection configuration
- 2.Check the current flow-based redirection configuration
- 3.Configure the vlan redirection function of the port
- 4.Configure the maximum number of vlan of redirect on each port

1. Flow-based redirection configuration

Command	Explanation
Physical Interface Configuration Mode	
access-group <aclname> redirect to interface [ethernet <IFNAME> <IFNAME>] no access-group <aclname> redirect	Specify flow-based redirection for the port; the “ no access-group <aclname> redirect ” command is used to delete flow-based redirection.

2. Check the current flow-based redirection configuration

Command	Explanation
Global Mode/Admin Mode	
show flow-based-redirect { interface [ethernet <IFNAME> <IFNAME>]}	Display the information of current flow-based redirection in the system/port.

3. Configure the vlan redirection function of the port

Command	Explanation
Port Mode	
match vlan <1-4096> redirect interface (ethernet) IFNAME no match vlan <1-4096> redirect	Configure the vlan redirection function of the port.
port-redirect match vlan <1-4094> source-port interface (ethernet) IFNAME destination-port interface (ethernet) IFNAME no port-redirect match vlan <1-4094> source-port interface (ethernet) IFNAME destination-port interface (ethernet) IFNAME	Configure the vlan redirection function of the port.

4. Configure the maximum number of vlan of redirect on each port

Command	Explanation
Global Mode	
vlan-port-redirect vlan maximum <1-1000> no vlan-port-redirect vlan maximum	Configure the maximum number of vlan of redirect on each port.

7.13.3 Flow-based Redirection Examples

Example:

User's request of configuration is listed as follows: redirecting the frames whose source IP is 192.168.1.111 received from port 1 to port 6, that is sending the frames whose source IP is 192.168.1.111 received from port 1 through port6.

Modification of configuration:

- 1: Set an ACL, the condition to be matched is: source IP is 192.168.1.111;
- 2: Apply the redirection based on this flow to port 1.

The following is the configuration procedure:

```
Switch(config)#access-list 1 permit host 192.168.1.111
Switch(config)#interface ethernet 1/0/1
Switch(Config-If-Ethernet1/0/1)# access-group 1 redirect to interface ethernet 1/0/6
```

7.13.4 Flow-based Redirection Troubleshooting Help

When the configuration of flow-based redirection fails, please check that whether it is the following reasons causing the problem:

- ✎ The type of flow (ACL) can only be digital standard IP ACL, digital extensive IP ACL, nomenclature standard IP ACL, nomenclature extensive IP ACL, digital standard IPv6 ACL, and nomenclature standard IPv6 ACL;
- ✎ Parameters of **Timerange** and **Portrange** can not be set in ACL, the type of ACL should be Permit.
- ✎ The redirection port must be 1000Mb port in the flow-based redirection function.
- ✎ Do not implement the forward across VLAN for flow-based redirection.

7.14 Egress QoS

7.14.1 Introduction to Egress QoS

In traditional IP networks, all packets are treated in the same way. All network equipments treat them by the first-in-first-out policy and try best effort to send them to the destination. However, it does not guarantee the performance like reliability and transmission delay. Network develops so fast that new demand has been raised for the quality of service on IP network with the continual emergence of new applications. For example, delay-sensitive services like VoIP and video put higher demands on packet transmission delay and users cannot accept too long transmission delay (by contrast, E-mail and FTP services are not sensitive to the time delay). In order to support services with different service requirement like voice, video and data service, the network is required to be able to distinguish between different communications and provide appropriate service. The traditional best-effort IP network cannot identify and distinguish various kinds of communications while this ability is the very premise of providing differentiated services for different communications. Therefore, the best-effort service mode of traditional network cannot meet the demand of applications. The emergence of QoS techniques is committed to solve this problem.

Egress PolicyMap is the QoS policy in egress which performs QoS control of packets in the egress direction and provides better service for specified network communication with kinds of techniques. Egress PolicyMap includes class-map and policy-map, of which class-map is used for selecting packets to operate and policy-map is used for specifying the operation to use. Not all equipments support Egress QoS currently.

7.14.1.1 Egress QoS Terms

Egress QoS: Achieving QoS on egress of port.

Inner_vid: VLAN ID brought by the TAG near the header of network layer when double TAGs exist.

Outer_vid: VLAN ID brought by the TAG near the header of network link layer when double TAGs exist. The TAG is considered to be outer tag by default when only one TAG exists.

Outer_tpid: Protocol type of the network link layer header indicating the type of outer tag.

7.14.1.2 Basic Egress QoS Model

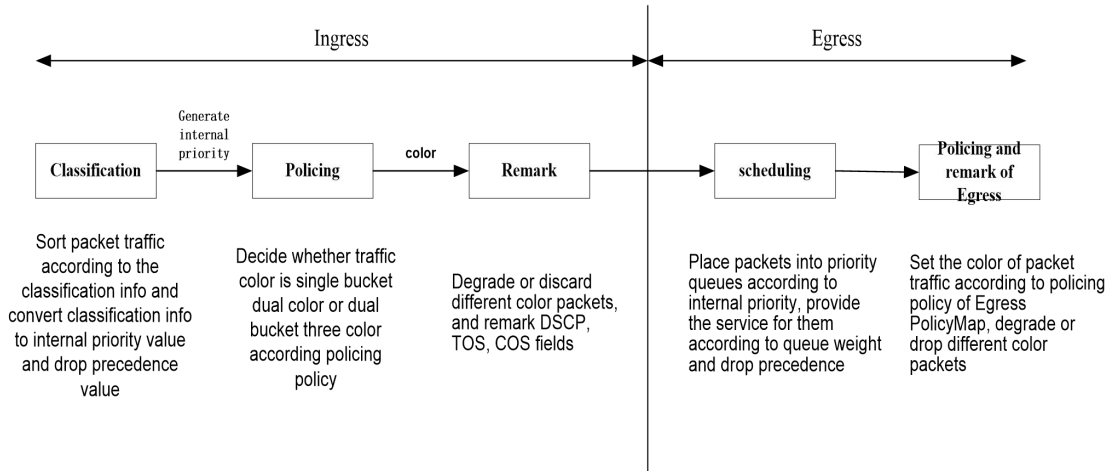

According to the characters (including field values like COS and DSCP) of upstream packets, policing and rewriting of Egress make the last QoS change on the packet prior to the packet egress.

Policing configures different policing policy based on the flow and distributes bandwidth for the flow classified. The distribution policy of bandwidth can be either dual bucket dual color or dual bucket three color. Different colors can be assigned to different flows and approaches of discard or passage can be chosen for them; you can add rewriting action for packets with passage approach chosen. See the following flow chart for detailed description of Egress QoS:

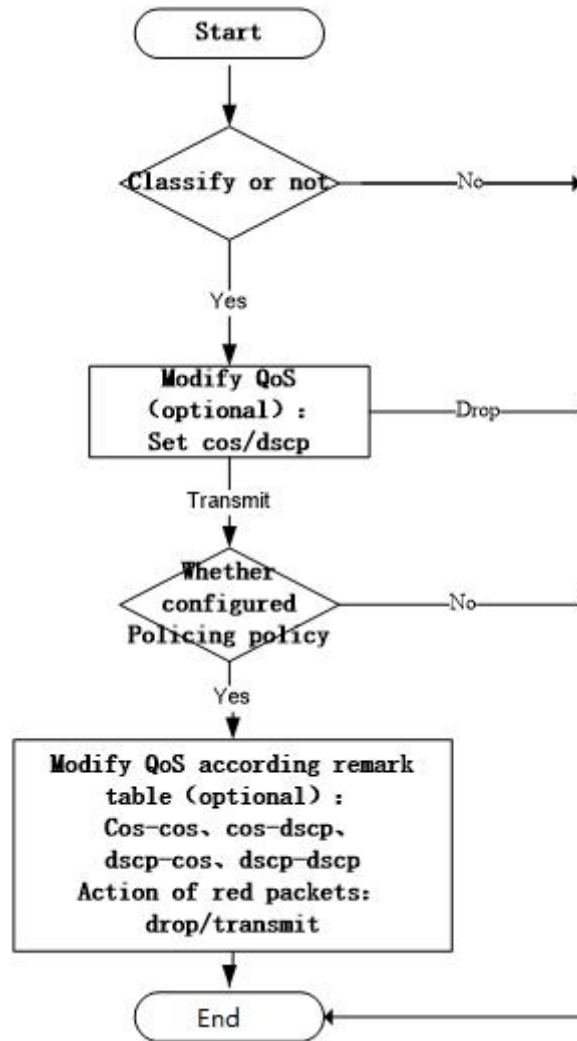

Description of action that modify QoS attribute according to egress remark table:

cos-cos: for cos value of packets, modify cos value of packets according to cos table of QoS remarking

cos-dscp: for cos value of packets, modify dscp value of packets according to cos table of QoS remarking

dscp-cos: for dscp value of packets, modify cos value of packets according to dscp table of QoS remarking

dscp-dscp: for dscp value of packets, modify dscp value of packets according to dscp table of QoS remarking

7.14.2 Egress QoS Configuration

Egress QoS Configuration Task List:

Configure class map

Set up a classification rule according to ACL, CoS, VLAN ID, IPv4 Precedent, DSCP, IPV6 DSCP to classify the data stream. Different classes of data streams will be processed with different policies.

Configure policy map

After data stream classification, a policy map can be created to associate with a class map created earlier and enter policy class mode. Then different policies (such as bandwidth limit, assigning new DSCP value) can be applied to different data streams.

Apply Egress QoS to port or VLAN

Configure the trust mode or binding policies for ports. A policy will only take effect on a port when it is bound to that port.

The policy may be bound to the specific VLAN.

Set Egress QoS remark mapping

If modify QoS attribute by using Egress QoS remark in policy, it should set the corresponding mapping. If it needs to take effect to green packets, modifying switch of green packets should be enabled and ingress needs to trust the corresponding QoS attribute (qos/dscp/exp).

1. Configure a class-map

Command	Explanation
Global Mode	
class-map <class-map-name> no class-map <class-map-name>	Create a class-map and enter class-map mode, no command deletes the specified class-map.
match {access-group <acl-index-or-name> ip dscp <dscp-list> ip precedence <ip-precedence-list> ipv6 dscp <dscp-list> vlan <vlan-list> cos <cos-list> ipv6 access-group <acl-index-or-name>} no match {access-group ip dscp ip precedence ipv6 dscp vlan cos ipv6 access-group}	Configure the matched standard of the class map to classify the data stream according to ACL, CoS, VLAN ID, IPv4 Precedence, DSCP, IPv6 DSCP priority; no command deletes the specific matched standard.

2. Configure a policy-map

Command	Explanation
Global Mode	
policy-map <policy-map-name> no policy-map <policy-map-name>	Create a policy-map and enter policy-map mode, no command deletes the specific policy-map.
class <class-map-name> [insert-before <class-map-name>] no class <class-map-name>	Create a policy map to associate with a class map and enter policy class map mode, then different data streams can apply different policies and be assigned a new DSCP value. No command deletes the specified policy class map.

<pre>set {ip dscp <new-dscp> ip precedence <new-precedence> cos <new-cos> c-vid <new-c-vid> s-vid <new-s-vid> s-tpid <new-s-tpid>} no set {ip dscp ip precedence cos c-vid s-vid s-tpid}</pre>	<p>Assign a new DSCP, CoS and IP Precedence value for the classified flow, no command cancels the operation.</p>
<p>Single bucket mode:</p> <pre>policy <bits_per_second> <normal_burst_bytes> ({action ACTION} exceed-action drop transmit})</pre> <p>Dual bucket mode:</p> <pre>policy <bits_per_second> <normal_burst_bytes> [pir <peak_rate_bps>] <maximum_burst_bytes> [{action ACTION violate-action drop transmit}]</pre> <p>ACTION definition:</p> <pre>policied-cos-to-cos-transmit policied-cos-to-dscp-transmit policied-dscp-exp-to-cos-transmit policied-dscp-exp-to-dscp-transmit no policy</pre>	<p>Configure a policy for the classified flow. The non-aggregation policy command supports three colors. Analyze the working mode of the token bucket, whether it is single rate single bucket, single rate dual bucket or dual rate dual bucket, set corresponding action to different color packets. The no command will delete the configuration. Only specific switch supports single bucket mode.</p>
<pre>accounting no accounting</pre>	<p>Set statistic function for the classified flow. After enable this function under the policy class map mode, add statistic function to the flow of the policy class map. In single bucket mode, packets can only red or green when passing policy. In the print information, in-profile means green and out-profile means red. In dual bucket mode, there are three colors of packets in-profile means green and out-profile means red and yellow.</p>

3. Apply policy to port or VLAN

Command	Explanation
Interface Mode	
<pre>service-policy output <policy-map-name> no service-policy output {<policy-map-name>}</pre>	<p>Apply a policy map to the egress of the port; the no command deletes the specified policy map applied to the port or deletes all the policy maps applied on the egress direction</p>

	of the port .
Global Mode	
service-policy output <i><policy-map-name></i> vlan <i><vlan-list></i> no service-policy output <i>{<policy-map-name>}</i> vlan <i><vlan-list></i>	Apply a policy map to the egress of the VLAN; the no command deletes the specified policy map applied to the VLAN interface or deletes all the policy maps applied in the egress direction of the vlan interface .

4. Set Egress QoS remark mapping

Command	Explanation
Global Mode	
mls qos map {cos-cos cos-dscp} {green yellow red} <i><value1></i> <i><value2></i> ... <i><value8></i> no mls qos map {cos-cos cos-dscp} {green yellow red}	Set Egress cos mapping, no command restores the default configuration.
mls qos map {dscp-cos dscp-dscp} {green yellow red} <i><dscp list></i> to <i><value></i> no mls qos map {dscp-cos dscp-dscp} {green yellow red}	Set Egress dscp mapping, <i><dscp-list></i> means 1 to 8 dscp values, no command restores the default configuration.
mls qos egress green remark no mls qos egress green remark	Set Egress QoS remark mapping to take effect for green packets, no command does not take effect to green packets.

5. Clear accounting data of the specific ports or VLANs

Command	Explanation
Admin Mode	
clear mls qos statistics [interface <i><interface-name></i> vlan <i><vlan-id></i>]	Clear accounting data of the specified ports or VLAN Policy Map. If there are no parameters, clear accounting data of all policy map.

6. Show QoS configuration

Command	Explanation
Admin Mode	
show mls qos { interface [<i><interface-id></i>] [policy queuing] vlan <i><vlan-id></i> }	Show QoS configuration of the port.
show class-map [<i><class-map-name></i>]	Show the class map information of QoS.
show policy-map [<i><policy-map-name></i>]	Show the policy map information of QoS.
show mls qos maps {cos-cos cos-dscp dscp-cos dscp-exp} {green yellow red }	Show mapping relation of Egress QoS remark.

7.14.3 Egress QoS Examples

Example1:

On the egress of the port1, change cos value as 4 for the packet with dscp value of 0.

Create a class map:

```
switch(config)#class-map 1
switch(config-classmap-1)#match ip dscp 0
switch(config-classmap-1)#exit
```

Create a policy map:

```
switch(config)#policy-map 1
switch(config-policymap-1)#class 1
switch(config-policymap-1-class-1)#set cos 4
switch(config-policymap-1-class-1)#exit
switch(config-policymap-1)#exit
```

Bind a policy to the port:

```
switch(config)#in e 1/0/1
switch(config-if-ethernet1/0/1)#service-policy output 1
```

Example2:

On the egress of vlan10, change cos value as 4 for the packet with ipv6 dscp value of 7.

Create a class map:

```
switch(config)#class-map 1
switch(config-classmap-1)#match ipv6 dscp 7
switch(config-classmap-1)#exit
```

Create a policy map:

```
switch(config)#policy-map 1
switch(config-policymap-1)#class 1
switch(config-policymap-1-class-1)#set cos 4
switch(config-policymap-1-class-1)#exit
switch(config-policymap-1)#exit
```

Bind a policy to VLAN

```
switch(config)#service-policy output 1 vlan 10
```

Example 3:

In egress of port 1, limit the speed of packets. Set the bandwidth for packets to 1 Mb/s, with the normal burst value of 1 MB, the max burst value of 4 MB, set dscp value of 1 as 10 for green packets, set dscp value of yellow packets as 9 and drop red packets.

Create a class map

```

switch(config)#class-map c1
switch(config-classmap-c1)#match ip dscp 1
switch(config-classmap-c1)#exit
Create a policy map
switch(config)#policy-map p1
switch(config-policymap-p1)#class c1
switch(config-policymap-p1-class-c1)#policy      1000      1000      4000      action
policied-dscp-exp-to-dscp-transmit violate-action drop
switch(config-policymap-p1-class-c1)#exit
switch(config-policymap-p1)#exit
Set Egress dscp remark mapping
switch(config)#mls qos map dscp-dscp green 1 to 10
switch(config)#mls qos map dscp-dscp yellow 1 to 9
Set Egress remark to take effect for green packets
switch(config)#mls qos egress green remark
Set trust dscp mode on ingress
switch(config-if-port-range)#mls qos trust dscp
Bind policy to egress of port1
switch(config-if-ethernet1/0/1)#service-policy output p1

```

7.14.4 Egress QoS Troubleshooting Help

- ☞ Not all equipments support Egress QoS presently, so please make sure the current device supports this function.
- ☞ If the policy configured cannot bind to the port or VLAN, please check whether the match option in classification table is supported by the current device.
- ☞ If terminal printing suggests lack of resource, please make sure there is enough resource to send the current policy.
- ☞ If the policy with match acl configured cannot bind to the port or VLAN, please make sure rules including permit exist in ACL.

If modifying QoS attribute is invalid by Egress QoS remark, please ensure whether ingress sets the correspondsing QoS attribute with trust.

- ☞ If egress set QoS attributes (set cos/ip dscp) for modifying all packets, and it uses Egress remark to modify QoS attributes for packets of different colors, previous modification is preferential for modifying packets.

7.15 Flexible QinQ

7.15.1 Introduction to Flexible QinQ

7.15.1.1 QinQ Technique

Dot1q-tunnel is also called QinQ (802.1Q-in-802.1Q), which is an expansion of 802.1Q. Its dominating idea is encapsulating the customer VLAN tag (CVLAN tag) to the service provider VLAN tag (SPVLAN tag). The packet with two VLAN tags is transmitted through the backbone network of the ISP internet to provide a simple layer-2 tunnel for the users. It is simple and easy to manage, applicable only by static configuration, and especially adaptive to small office network or small metropolitan area network using layer-3 switch as backbone equipment.

There are two kinds of QinQ: basic QinQ and flexible QinQ, the priority of flexible QinQ is higher than basic QinQ.

7.15.1.2 Basic QinQ

Basic QinQ based the port. After a port configures QinQ, whether the received packet with tag or not, the device still packs the default VLAN tag for the packet. Using basic QinQ is simple, but the setting method of VLAN tag is inflexible.

7.15.1.3 Flexible QinQ

Flexible QinQ based data flow. It selects whether pack the external tag and packs what kind of the external tag by matching the material flow. For example: implement the property of flexible QinQ according to the user's VLAN tag, MAC address, IPv4/IPv6 address, IPv4/IPv6 protocol and the port ID of the application, etc. So, it can encapsulate the external tag for the packet and implements different scheme by different users or methods.

7.15.2 Flexible QinQ Configuration Task List

The match of flexible QinQ data flow uses policy-map rule of QoS to be sent, the configuration task list is as follows:

1. Create class-map to classify different data flows
2. Create flexible QinQ policy-map to relate with the class-map and set the corresponding operation
3. Bind flexible QinQ policy-map to port

1. Configure class map

Command	Explanation
Global mode	
class-map <class-map-name>	Create a class-map and enter class-map

no class-map <class-map-name>	mode, the no command deletes the specified class-map.
match {access-group <acl-index-or-name> ip dscp <dscp-list> ip precedence <ip-precedence-list> ipv6 access-group <acl-index-or-name> ipv6 dscp <dscp-list> ipv6 flowlabel <flowlabel-list> vlan <vlan-list> cos <cos-list>} no match {access-group ip dscp ip precedence ipv6 access-group ipv6 dscp ipv6 flowlabel vlan cos}	Set the match standard of class-map, (classify data flow by ACL, CoS, VLAN ID, IPv4 Precedent or DSCP, etc for the class map); the no command deletes the specified match standard.

2. Configure policy-map of flexible QinQ

Command	Explanation
Global mode	
policy-map <policy-map-name> no policy-map <policy-map-name>	Create a policy-map and enter policy-map mode, the no command deletes the specified policy-map.
class <class-map-name> [insert-before <class-map-name>] no class <class-map-name>	After a policy-map is created, it can be associated to a class. Different policy or new DSCP value can be applied to different data flows in class mode; the no command deletes the specified class-map.
set s-vid <vid> no set s-vid	Set external VLAN Tag for the classified traffic, no command cancels the operation.
add s-vid <vid> no add s-vid <vid>	Add external VLAN Tag for the classified traffic, no command cancels the operation.

3. Bind flexible QinQ policy-map to port

Command	Explanation
Port mode	
service-policy input <policy-map-name> no service-policy input <policy-map-name>	Apply a policy-map to a port, the no command deletes the specified policy-map applied to the port.
Global mode	
service-policy input <policy-map-name> vlan <vid> no service-policy input <policy-map-name> vlan <vid>	Apply a policy-map to a VLAN, the no command deletes the specified policy-map applied to the VLAN.

4. Show flexible QinQ policy-map bound to port

Command	Explanation
Admin mode	
show mls qos {interface [<interface-id>]}	Show flexible QinQ configuration on the port.

7.15.3 Flexible QinQ Example

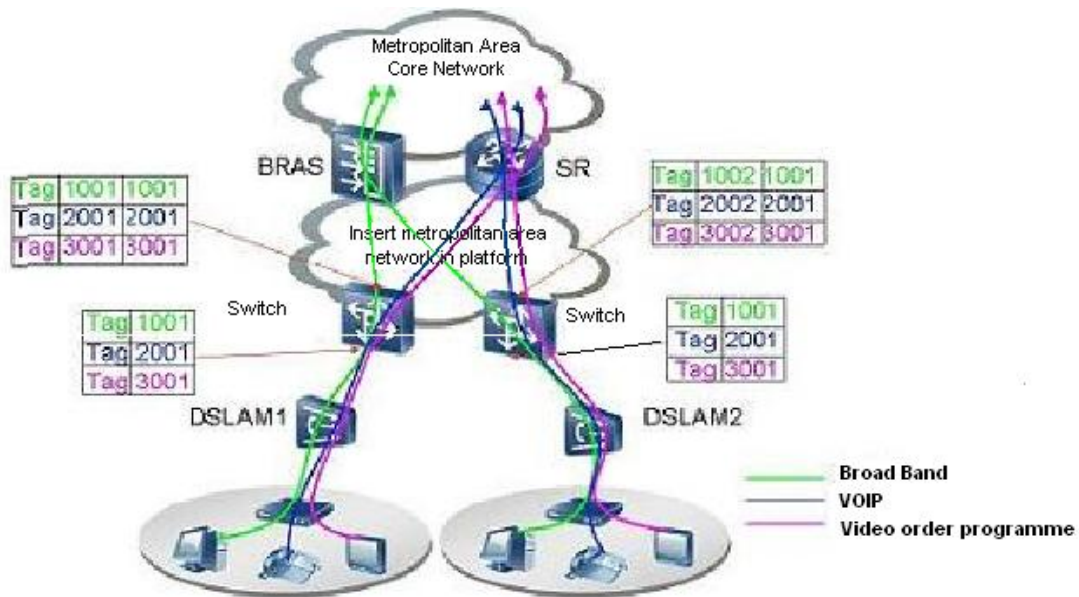

Figure 6-40 Flexible QinQ application topology

As shown in the figure, the first user is assigned three VLANs that the tag values are 1001, 2001, 3001 respectively in DSLAM1. VLAN1001 corresponds to Broad Band Network, VLAN2001 corresponds to VOIP, VLAN3001 corresponds to VOD. After the downlink port enables flexible QinQ function, the packets will be packed with different external tags according to VLAN ID of users. The packet with tag 1001 will be packed an external tag 1001 directly(This tag is unique in public network), enter Broad Band Network-VLAN1001 and classified to BRAS device. The packet with tag 2001(or 3001) will be packed an external tag 2001(or 3001) and classified to SR device according to the flow rules. The second user can be assigned different VLAN tags for different VLANs in DSLAM2. Notice: The assigned VLAN tag of the second user may be same with the first user and the packet with tag will be also packed an external tag. In the above figure, the external tag of the second user is different to the first user for distinguishing DSLAM location and locating the user finally.

The configuration in the following:

If the data flow of DSLAM1 enters the switch's downlink port1, the configuration is as follows:

```
Switch(config)#class-map c1
Switch(config-classmap-c1)#match vlan 1001
Switch(config-classmap-c1)#exit
Switch(config)#class-map c2
```

```
Switch(config-classmap-c2)#match vlan 2001
Switch(config-classmap-c2)#exit
Switch(config)#class-map c3
Switch(config-classmap-c3)#match vlan 3001
Switch(config-classmap-c3)#exit
Switch(config)#policy-map p1
Switch(config-policymap-p1)#class c1
Switch(config-policymap-p1-class-c1)# set s-vid 1001
Switch(config-policymap-p1)#class c2
Switch(config-policymap-p1-class-c2)# set s-vid 2001
Switch(config-policymap-p1)#class c3
Switch(config-policymap-p1-class-c3)# set s-vid 3001
Switch(config-policymap-p1-class-c3)#exit
Switch(config-policymap-p1)#exit
Switch(config)#interface ethernet 1/0/1
Switch(config-if-ethernet1/0/1)#service-policy input p1
```

If the data flow of DSLAM2 enters the switch's downlink port1, the configuration is as follows:

```
Switch(config)#class-map c1
Switch(config-classmap-c1)#match vlan 1001
Switch(config-classmap-c1)#exit
Switch(config)#class-map c2
Switch(config-classmap-c2)#match vlan 2001
Switch(config-classmap-c2)#exit
Switch(config)#class-map c3
Switch(config-classmap-c3)#match vlan 3001
Switch(config-classmap-c3)#exit
Switch(config)#policy-map p1
Switch(config-policymap-p1)#class c1
Switch(config-policymap-p1-class-c1)# set s-vid 1002
Switch(config-policymap-p1)#class c2
Switch(config-policymap-p1-class-c2)# set s-vid 2002
Switch(config-policymap-p1)#class c3
Switch(config-policymap-p1-class-c3)# set s-vid 3002
Switch(config-policymap-p1-class-c3)#exit
Switch(config-policymap-p1)#exit
Switch(config)#interface ethernet 1/0/1
Switch(config-if-ethernet1/0/1)# service-policy input p1
```

7.15.4 Flexible QinQ Troubleshooting

If flexible QinQ policy can not be bound to the port, please check whether the problem is caused by the following reasons:

- 👉 Make sure flexible QinQ whether supports the configured class-map and policy-map
- 👉 Make sure ACL includes permit rule if the class-map matches ACL rule

- ☞ Make sure the switch exists enough TCAM resource to send the binding
- ☞ Priority of flexible QinQ and vlan ingress filtering for processing packets is: flexible QinQ > vlan ingress filtering

7.16 Captive Portal Authentication

7.16.1 Captive Portal Authentication Configuration

7.16.1.1 Introduction to Captive Portal Authentication

The authentication function is a way to manage and control the network resources for users. Authentication function memories the client authentication information in the authentication server according to a certain principles. When a user needs to use the network resources, the function of captive portal will redirect the network request of user to the authentication server, and then the user needs to provide allowed username, password and other information, the authentication server will judge the information of user and decide whether the user can be allowed to use the network resources. The switch in authentication function plays a role of communicating the user and the authentication server. Through the switch configuration, it enables the user could connect and communicate with the authentication server, and the server will analyze the data and provide the corresponding feedback to the user. Authentication function based on the redirection function.

Redirection is a function of re-connecting the original request to a predetermined site and continuous to operate. The function is when the AP receives a client request, then transfer the client request to a predetermined address, after the operation of the client and the redirected address, in order to complete certain functions and operations. This operation can achieve the aim to manage and monitor the user. Client redirected to portal authentication interface, requiring the user to fill in the username and password, only when the username and password pass the certification and they can use the network resources. Portal authentication can achieve different control strategies for different types of users.

The portal server function is a way to configure different external portal server for different CP configuration. When network bind different CP configuration, has configured different portal server, it will launch the redirect page through their binding portal server. You can configure up to 10 external portal servers. Each CP configuration can bind one portal server.

7.16.1.2 Captive Portal Authentication Configuration

Authentication function task list is as below:

1. Enable/disable captive portal authentication function
2. Configure captive portal redirect function
 - 1) Configure or delete the portal server name
 - 2) Configure the user instance
 - 3) Configure redirect address
 - 4) Configure the redirect url-head
 - 5) Configure/delete radius server name
 - 6) Configure to bind or relieve the portal server

- 7) Configure the url to carry the parameter of ac-name
- 8) Configure the url to carry the parameter of ssid
- 9) Configure the url to carry the parameter of nas-ip
3. Configure AAA function
 - 1) Enable/stop AAA function
 - 2) Configure RADIUS authentication server group name
4. Configure RADIUS authentication server
 - 1) Configure RADIUS server key
 - 2) Configure RADIUS authentication server address
5. Bind the portal rule to the port

1. Enable/disable captive portal authentication function

Command	Explanation
Captive Portal Configuration Mode	
enable	Enable/disable captive portal function globally.
disable	

2. Configure captive portal redirect function

Command	Explanation
Captive Portal Configuration Mode	
external portal-server server-name <name> {ipv4 ipv6} <ipaddr> [port <1-65535>] no external portal-server {ipv4 ipv6}server-name <name>	Configure/delete external portal server.
nas-ip4 <A.B.C.D>	Configure the nas-ip address.
configuration <cp-id> no configuration <cp-id>	Configure/delete portal routine of different types of users. 10 kinds of routines can be configured.
Captive Portal Instance Configuration Mode	
redirect url-head <word> no redirect url-head	Configure the redirect url-head including transmission protocol, host name, port and path. The no command deletes the configuration.
radius-auth-server <server-name> no radius-auth-server	Configure/delete authentication server name.
portal-server {ipv4 ipv6} <name> no portal-server {ipv4 ipv6}	Bind/unbind portal server name.
enable disable	Enable/disable a portal routine.
ac-name <word>	Configure the url to carry the

no ac-name	parameter of acname. The no command deletes it.
redirect attribute ssid name <word> no redirect attribute ssid name	Configure the url to carry the parameter of ssid. The no command recovers the ssid to be the default value.
redirect attribute nas-ip enable no redirect attribute nas-ip enable	Configure the url to carry the parameter of nas-ip. The no command disables this function.
redirect attribute nas-ip name <word> no redirect attribute nas-ip name	Configure the name of the parameter of nas-ip carried in url. The no command recovers the name to be the default value.

3. Configure AAA function

Command	Explanation
Global Mode	
aaa enable no aaa enable	Enable/stop the AAA function of a captive portal routine.
aaa group server radius <word> no aaa group server radius <word>	Configure/delete RADIUS name of AAA function.

4. Configure RADIUS authentication server

Command	Explanation
Global Mode	
radius-server key <word> no radius-server key	Configure/delete RADIUS server key.
radius-server authentication host <A.B.C.D> no radius-server authentication host <A.B.C.D>	Configure/delete RADIUS authentication server address.

5. Bind the portal rule to the port

Command	Explanation
Captive Portal Instance configuration mode	
interface [ethernet] IFNAME vlan [add remove] WORD no interface [ethernet] IFNAME	Enable the port portal authentication function and appoint the instance number which is bound to the port. It can also appoint which vlan to be

	enabled portal. If the vlan is not appointed, all vlan is enabled portal as default. The no command disables the portal authentication function of the port. (necessary)
--	--

7.16.1.3 Captive Portal Authentication Examples

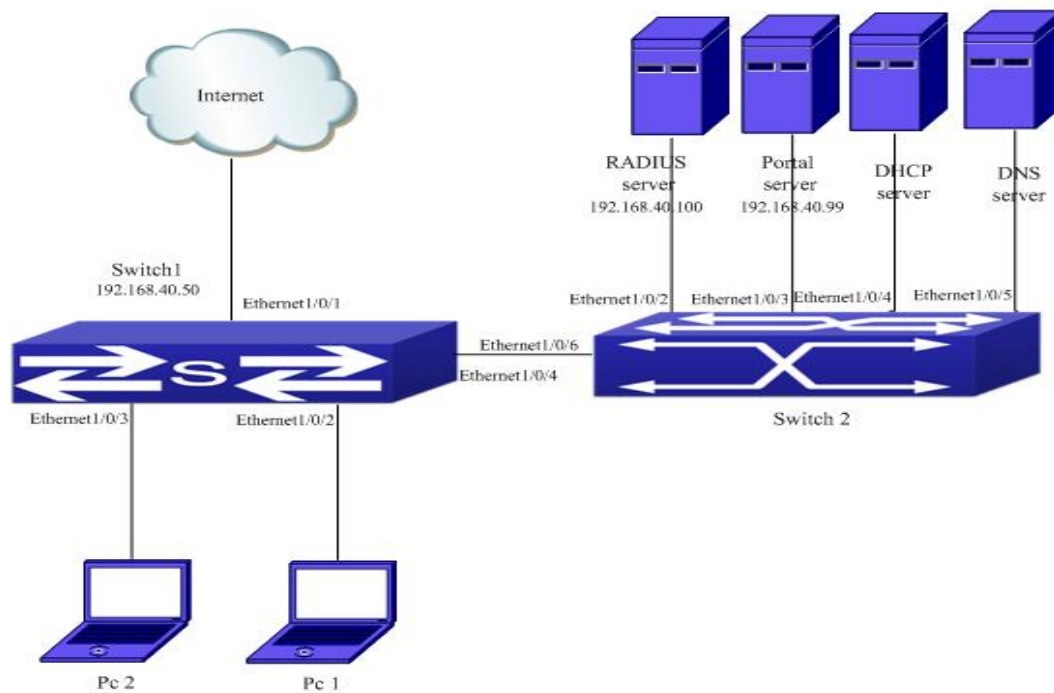

Fi

Figure 6-24 authentication function configuration

As shown above, pc1 is the terminal client, there is the http browser but not the 802.1x authentication client, pc1 wants to access the network through the portal authentication.

The switch1 is the accessing device with the configured accounting server address as the IP and port of the radius server, and it is enabled the accounting function. The Ethernet1/0/2 is connected to pc1, the port is enabled portal authentication function, and the redirection address is configured as the IP and port of the portal server. So the Ethernet1/0/2 forbids all the traffic and only allows the dhcp/dns/arp packets.

The switch2 is the convergence switch, the Ethernet1/0/2 is communicated to the radius server, the Ethernet1/0/3 is communicated to the portal server. The address of the radius server is 192.168.40.100, and the address of the portal server is 192.168.40.99. The Ethernet1/0/4 is connected to DHCP server and the Ethernet1/0/5 is connected to DNS server. The Ethernet1/0/6 is the trunk port and connected to the Ethernet1/0/4 of the trunk port of switch1.

Configure the radius server:

```
switch (config)#radius-server key 0 test
```

```
switch (config)#aaa group server radius radius_aaa_1
switch (config-sg-radius)# server 192.168.40.100
```

The configuration of global authentication:

```
Switch(config)#interface vlan 1
Switch(config-if-vlan1)#ip address 192.168.40.50 255.255.255.0
Switch(config)#free-resource 1 destination ipv4 192.168.40.99/32
Switch(config)# vlan-pool 1 2-10
```

Configure the portal function and portal server under the portal instance:

```
Switch (config)#captive-portal
Switch (config-cp)#enable
Switch(config-cp)# nas-ipv4 192.168.40.50
Switch(config-cp)# external portal-server server-name abc ipv4 192.168.40.99
Switch (config-cp)# configuration 1
Switch (config-cp-instance)#name helix4
Switch (config-cp-instance)#radius-auth-server abc99
Switch (config-cp-instance)# redirect attribute nas-ip enable
Switch (config-cp-instance)#redirect attribute nas-ip name kk
Switch (config-cp-instance)#ac-name helix4
Switch (config-cp-instance)#redirect url-head http://192.168.40.99/a70.htm
Switch (config-cp-instance) # portal-server ipv4 abc
```

Enable the portal function on the port:

```
Switch (config-cp-instance) #interface ethernet 1/0/2 vlan add 1
```

7.16.1.4 Captive Portal Authentication Troubleshooting

Encounter problems when using the redirection function, please check whether the reasons are as follows:

- ☞ Whether launched the captive portal function and opened the portal configuration switch. Both the captive portal and the portal configuration should be open; otherwise, the captive portal function will not work, the client also cannot be redirect to the specified page.
- ☞ The authentication server name of AAA module is same to the configured authentication name of captive portal.
- ☞ Whether the port which connects the pc and switch is enabled portal authentication function.

7.16.2 Accounting Function Configuration

7.16.2.1 Introduction to Accounting Function

The accounting function is used to monitoring and accounting users who using the network

resources. Client is unable to access the network resources before pass the captive portal authentication, only through the portal authentication to access network resources. Define user's session duration to control the use of network resources time and flow of information.

7.16.2.2 Accounting Function Configuration

Accounting function configuration task list is as below:

1. Configure RADIUS accounting server
 - 1) Configure/delete accounting server address
2. Configure AAA accounting function
 - 1) Enable/disable accounting service function
3. Configure captive portal accounting function
 - 1) Block/unblock portal function
 - 2) Configure/delete captive portal configuration name
 - 3) Enable/disable captive portal accounting function
 - 4) Configure/delete captive portal accounting server name
 - 5) Configure/delete captive portal session time

1. Configure RADIUS accounting server

Command	Explanation
Global Mode	
radius-server accounting host <A.B.C.D> no radius-server accounting host <A.B.C.D>	Configure/delete accounting server address

2. Configure AAA accounting function

Command	Explanation
Global Mode	
aaa-accounting enable no aaa-accounting	Enable/disable accounting service function

3. Configure captive portal accounting function

Command	Explanation
Captive Portal Configuration Mode	
block no block	Block/unblock portal function
name <word> no name	Configure/delete captive portal configuration name
radius accounting no aaa-accounting	Enable/disable captive portal accounting function

radius-acct-server <word>	Configure/delete captive portal
no radius-acct-server	accounting server name
session-timeout <0-86400>	Configure/delete captive portal
session-timeout	session time

7.16.2.3 Accounting Function Examples

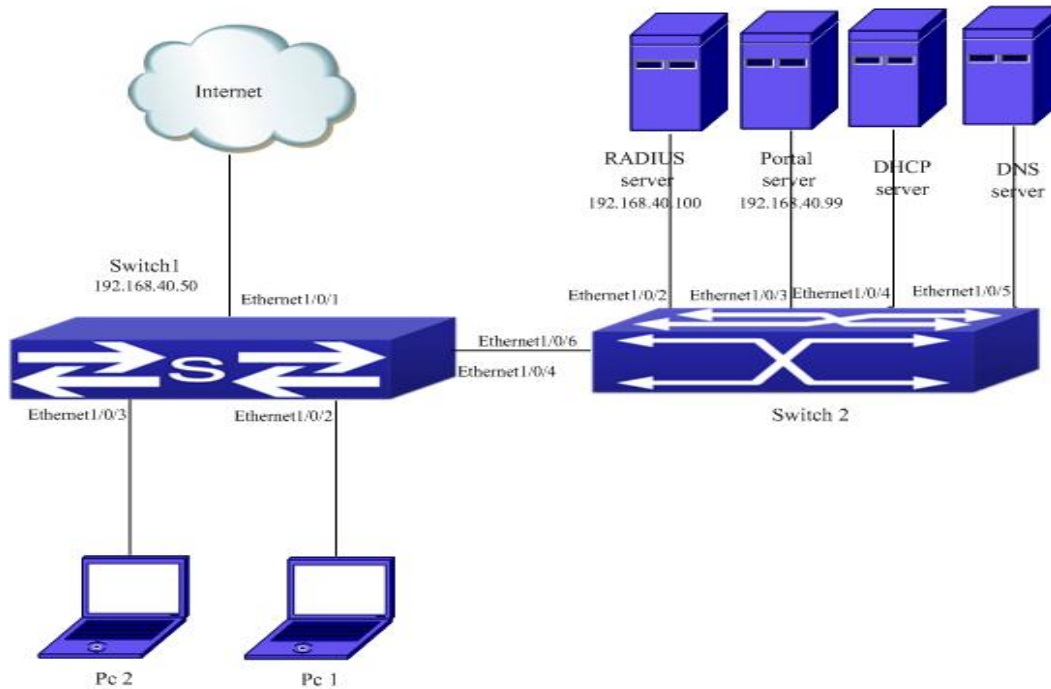

Figure 6-25 accounting function configuration

1. Configure the AAA accounting function on switch1.

AAA configuration of Switch1:

```
switch 1(config)# aaa enable
```

```
switch 1(config)# aaa-accounting enable
```

```
switch 1(config)# radius-server accounting host 192.168.40.100
```

```
switch1 (config)#radius-server key 0 test
```

```
switch1 (config)#aaa group server radius abc99
```

```
switch (config-sg-radius)# server 192.168.40.100
```

2. Configure the captive portal accounting function on switch1.

```
Switch 1(config)#captive-portal
```

```
Switch 1(config-cp)#enable
```

```
Switch1 (config-cp)# configuration 1
```

```
Switch1 (config-cp-instance)#radius accounting
```

```
Switch1 (config-cp-instance)# radius-acct-server abc99
```

7.16.2.4 Accounting Function Troubleshooting

Encounter problems when using the accounting function, please check whether the reasons are as follows:

- ☞ Whether launched the captive portal function and opened the portal configuration switch. Both the captive portal and the portal configuration should be open; otherwise, the captive portal function will not work, the client also cannot be redirect to the specified page.
- ☞ The authentication server name of AAA module is same to the configured authentication name of captive portal.

7.16.3 Free-resource Configuration

7.16.3.1 Introduction to Free-resource

Free-resource function is a method of captive portal module to achieve access the free resources rule. By configuring the free-resource rules, one can makes certain the client directly access the specific network resources without going through the portal authentication.

7.16.3.2 Free-resource Configuration

1. Configure the free-resource rule

Command	Explanation
Config Mode	
free-resource destination {ipv4 A.B.C.D/M ipv6 X:X:X:X/M} [no] free-resource destination {ipv4 A.B.C.D/M ipv6 X:X:X:X/M}	Configure or delete the free-resource rule.

7.16.3.3 Free-resource Examples

Case:

Set up an environment as shown below. The IP is the address segment for the Client1, and the Destination IP is the address segment for client who wants to access the resources. Appoint RADIUS server 1 as the authentication server, client1 and client2 can access the free-resource of 3.1.1.0/24 and will not be redirected to the authentication server.

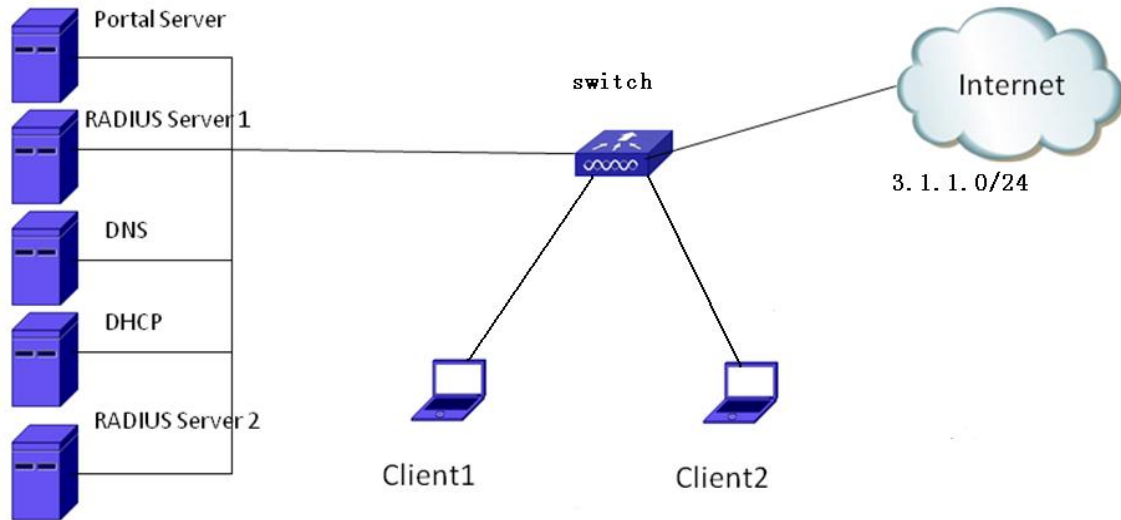

Figure 6-26 multi-portal servers function configuration

Configuration steps:

```
Switch1(config)# free-resource destination ipv4 3.1.1.0/24
```

7.16.3.4 Free-resource Troubleshooting

Encounter problems when using the redirection function, please check whether the reasons are as follows:

- ☞ Whether launched the captive portal function and opened the portal configuration switch. Both the captive portal and the portal configuration should be open; otherwise, the captive portal function will not work, the client also cannot be redirect to the specified page.
- ☞ Whether the port which connects the client and switch is enabled portal rule.

7.16.4 Authentication White-list Configuration

7.16.4.1 Introduction to Authentication White-list

Authentication white-list is used for some special users in the network. The administrator can set permission to allow the users to connect to the network to use network resources without authentication, but the administrator needs to get the user's mac address. At the same time the user who has the permission to use network resources do not need to billing. So the user belongs to the advanced user.

7.16.4.2 Authentication White-list Configuration

1. Configure user mac with Authentication white-list function purview

Command	Explanation
Config Mode	
free mac <MACADD><MACMASK>	Configure or delete the mac address

no free mac < MACADD><MACMASK>

without needing to authenticate.

7.16.4.3 Authentication White-list Examples

Case:

As shown below, client1 and client2 are the terminal clients; the port connected to the switch is enabled portal authentication. But these two clients are the advanced users, they need no authentication to access the network.

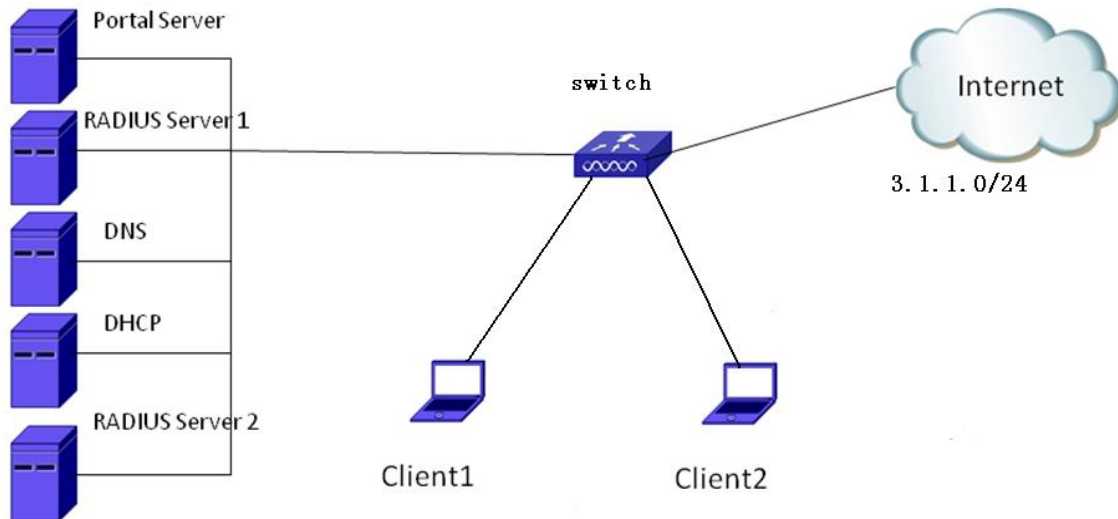

Figure 6-27 Authentication White-list function configuration

Configuration steps:

Configure the authentication white-list for pc1 and pc2.

```
Switch1 (config)#free-mac 68-74-7f-29-76-04 ff-ff-ff-ff-ff-ff
```

```
Switch1 (config)#free-mac 00-03-0f-11-11-11 ff-ff-ff-ff-ff-ff
```

7.16.4.4 Authentication White-list Troubleshooting

When encountered problems in the process of using the Authentication White-list function, please check whether the reasons are as follows:

- ☞ Whether the free mac and the client mac is matching.
- ☞ Whether the port which connects the client and switch is enabled the portal rule.

7.16.5 Automatic Page Pushing after Successful Authentication (it is not supported currently)

7.16.5.1 Introduction to Automatic Page Pushing after

Successful Authentication

The automatic page pushing function after the successful authentication means that the web page which user needs to access can be re-opened after the authentication. According to the actual situation, the welcome page before the automatic pushing authentication or the appointed web page by the automatic pushing function can be configured.

7.16.5.2 Automatic Page Pushing after Successful Authentication Configuration

Automatic Page Pushing after Successful Authentication Configuration is as below:

1. Enable/disable the captive portal authentication function
2. Configure the automatic page pushing after successful authentication

1. Enable/disable the captive portal authentication function

Command	Explanation
Captive Portal Mode	
enable disable	Enable/disable the captive portal authentication function on the switch.

2. Configure the automatic page pushing after successful authentication

Command	Explanation
Captive Portal Instance Mode	
redirect attribute url-after-login enable no redirect attribute url-after-login enable	Enable the function that the redirect url carries the pushed url after the successful authentication. The no command disables it.
redirect attribute url-after-login name <name> no redirect attribute url-after-login name	Configure the attribute name of the pushed url after the successful authentication which is carried in the redirect url. The no command recovers the name to be the default value.
redirect attribute url-after-login encode {plain-text base64}	Configure the encode of the pushed url after the successful authentication which is carried in the redirect url.
redirect attribute url-after-login value <url-value> no redirect attribute url-after-login value	Configure the appointed url which is popped up after the successful authentication. The no command deletes it.

7.16.5.3 Automatic Page Pushing after Successful Authentication Example

Case:

Configure the automatic page pushing after successful authentication on configuration1 of <http://www.test.com>.

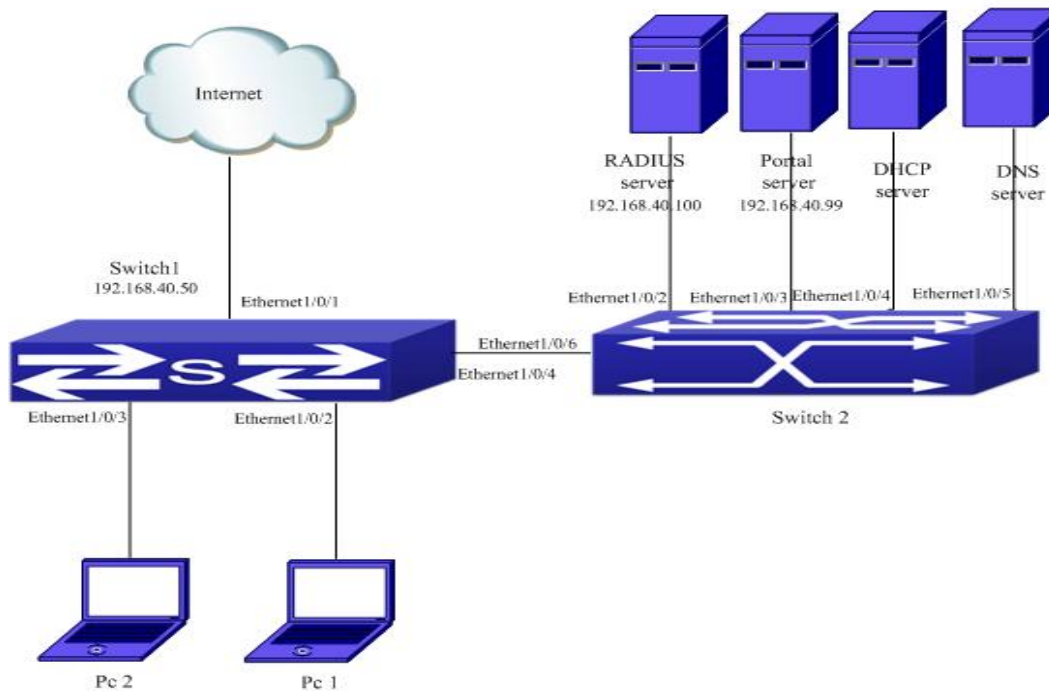

Figure 6-28 Automatic Page Pushing after Successful Authentication Configuration

Configuration steps:

Configure the portal server information for switch1.

```
switch1 (config-cp)#enable
switch1 (config-cp)#configuration 1
switch1 (config-cp-instance)#enable
switch1 (config-cp-instance)# redirect attribute url-after-login enable
switch1 (config-cp-instance)# redirect attribute url-after-login encode plain-text
switch1 (config-cp-instance)# redirect attribute url-after-login name ad
switch1 (config-cp-instance)# redirect attribute url-after-login value http://www.test.com
```

7.16.5.4 Automatic Page Pushing after Successful

Authentication Troubleshooting

When there is problem in using the automatic page pushing function after the successful authentication, please check the following reasons:

- ☞ Check if the captive portal authentication function is configured correctly. The automatic page pushing function after the successful authentication can be effect when the captive portal function is normal.
- ☞ If the command of **redirect attribute url-after-login value** is configured, the configured page url can be pushed automatically after the authentication; if that command is not configured, the page that the user access before the authentication can be pushed.

- ☞ Check if the page before the authentication or the pushed page appointed by command exists, if not, the page cannot be accessed after pushing.

7.16.6 http-redirect-filter

7.16.6.1 Introduction to http-redirect-filter

http-redirect-filter appoints the IP or domain name for the HTTP redirection of portal authentication. Only the HTTP packet configured this IP or domain name can be redirected.

This function can be used with Captive Portal, which means to achieve filtering the user accessing after enabled captive portal.

7.16.6.2 http-redirect-filter Configuration

http-redirect-filter configuration task list:

1. Configure the http-redirect-filter rule
2. Bind the http-redirect-filter rule to cp instance

1. Configure the http-redirect-filter rule

Command	Explanation
Captive Portal Mode	
http-redirect-filter <1-32> (ip A.B.C.D domain WORD) no http-redirect-filter (<1-32> all)	Configure the http-redirect-filter rule. The no communicated deletes it.

2. Bind the http-redirect-filter rule to cp instance

Command	Explanation
Captive Portal Mode	
http-redirect-filter <1-32> no http-redirect-filter (<1-32> all)	Bind a rule to a instance of the captive portal. The no command deletes the redirect binding.

7.16.6.3 http-redirect-filter Examples

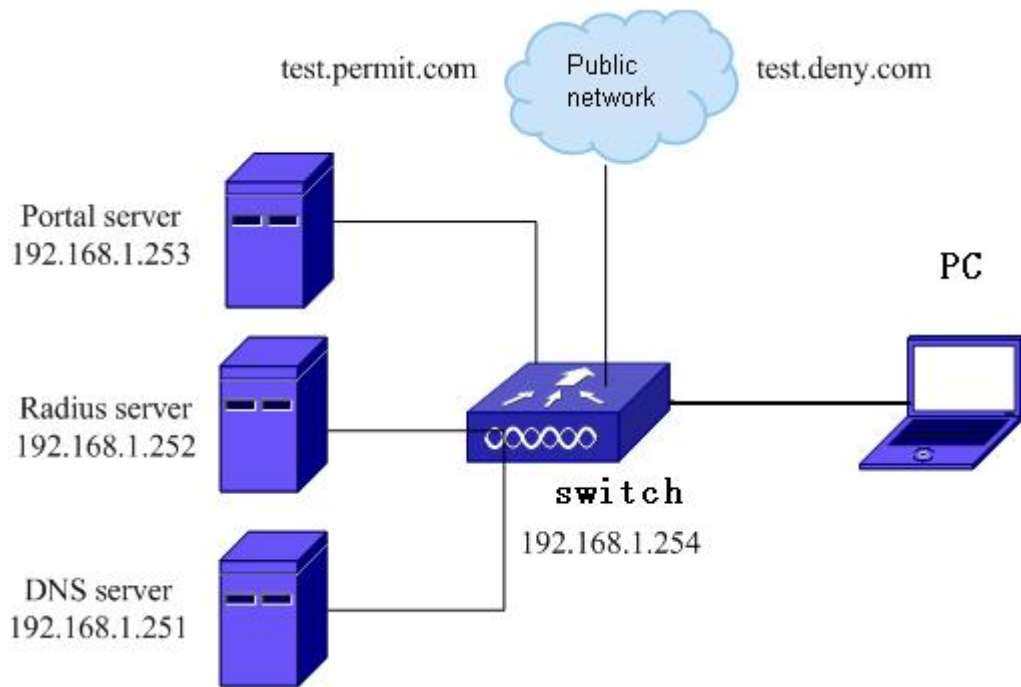

Figure 6-29 http-redirect-filter function case

As shown above, if client wants to access the public network of “test.permit.com” before the portal authentication, the url white list should be configured. If client wants to be forbidden to access the public network of “test.deny.com” after the portal authentication, the url black list should be configured.

Configure with the following steps:

1. Configure the related authentication key, authentication server, accounting server and aaa mode of the radius server under the global mode:

```
switch (config)#radius-server key 0 test
switch (config)#radius-server authentication host 192.168.1.252
switch (config)#radius-server accounting host 192.168.1.252
switch (config)#aaa-accounting enable
switch (config)#aaa enable
switch (config)#aaa group server radius radius_aaa_1
switch config-sg-radius)# server 192.168.1.252
switch(config)#interface vlan 192
switch(config-if-vlan1)#ip address 192.16.1.254 255.255.255.0
switch(config)#free-resource 1 destination ipv4 192.168.1.252/32
```

2. Configure the portal function, portal server under the portal instance:

```
Switch (config)#captive-portal
Switch (config-cp)#enable
Switch(config-cp)# nas-ipv4 192.168.1.254
Switch(config-cp)# external portal-server server-name abc ipv4 192.168.1.253
```

```
Switch (config-cp)# configuration 1
Switch (config-cp-instance)#enable
Switch (config-cp-instance)#name helix4
Switch (config-cp-instance)#radius accounting
Switch (config-cp-instance)#radius-acct-server abc99
Switch (config-cp-instance)#radius-auth-server abc99
Switch (config-cp-instance)#redirect attribute nas-ip enable
Switch (config-cp-instance)#ac-name helix4
Switch (config-cp-instance)#redirect url-head http://192.168.1.253/a70.htm
Switch (config-cp-instance)#portal-server ipv4 abc
```

3. Configure the http-redirect-filter rule:

```
Switch (config)#captive-portal
Switch (config-cp)# http-redirect-filter 1 domain test.permit.com
Switch (config-cp)#configuration 1
Switch (config-cp-instance)# http-redirect-filter 1
```

4. Enable the portal function on the port:

```
Switch (config)# interface ethernet1/0/2
Switch (config-if-ethernet1/0/2)#portal enable configuration 1
```

The client can be redirected authentication only through accessing “test.permit.com” before authentication. It cannot be redirected authentication by accessing other address.

7.16.6.4 http-redirect-filter Troubleshooting

If there are problems in using http-redirect-filter function, please check it with the following steps:

- ☞ Check if the configured rule is matching to the accessed domain name.
- ☞ If the DNS server configuration is correct and if it can analyse the configured domain name correctly.
- ☞ If the command of http-redirect-filter under captive-portal configuration is configured.

7.16.7 Portal Non-perception

7.16.7.1 Introduction to Portal Non-perception

MAC authentication has the user experience that is "a authentication, multiple use". If you opened the fast authentication of MAC, the user successfully authenticates the first landing Portal

page, subsequent user can use any application.

In order to achieve a large number of user's fast authentication of MAC, user must use an external server to save the MAC binding information, and add it dynamically but not manually. This new realization of the program is called fast authentication of MAC scheme, since the user does not need to manually enter the user name and password for authentication when access network again, also known as Portal non-perception of authentication scheme.

7.16.7.2 Portal Non-perception Configuration

1. Enable/disable the quick mac authentication function

Command	Explanation
Captive Portal Config Mode	
fast-mac-auth	Enable/disable the quick mac authentication function.
no fast-mac-auth	

7.16.7.3 Portal Non-perception Examples

The created environment is as the following figure including the parts as below:

1. PC, user can access the network through the switch.
2. Public network, this part can be free or other switch devices.
3. Server, it includes:

MAC binding server, it is used to save the authenticated terminal mac address;

Radius server, it is used for the portal authentication and accounting;

Portal server, it is used for the portal authentication;

MAC binding server, Radius server and portal server can be the same one device. The mac binding server is the spread on the radius server.

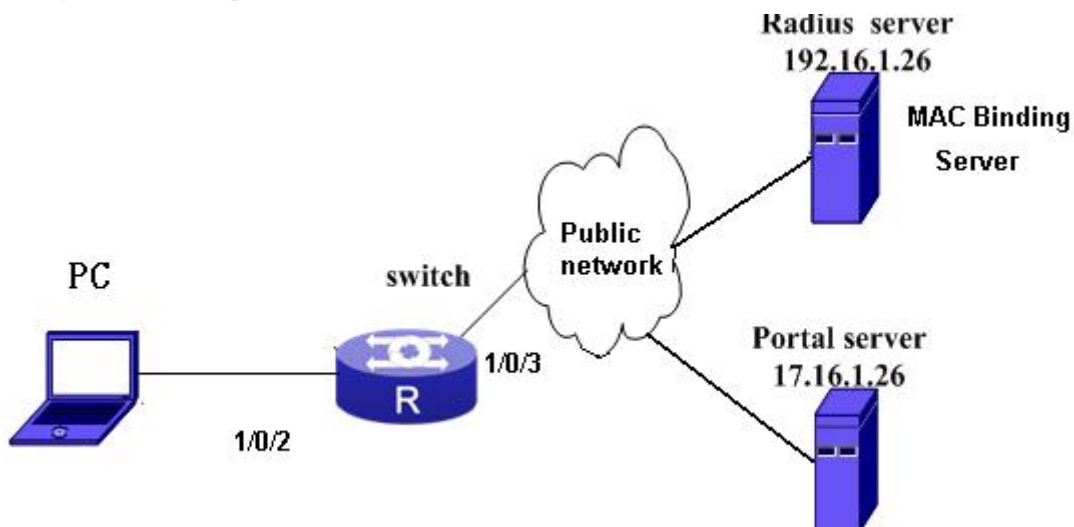

Figure 6-30

Configure as the following steps:

1. Configure the related authentication key, authentication server, accounting server and aaa mode of the radius server under the global mode:

```
switch (config)#radius-server key 0 test
switch (config)#radius-server authentication host 192.16.1.26
switch (config)#radius-server accounting host 192.16.1.26
switch (config)#aaa-accounting enable
switch (config)#aaa enable
switch (config)#aaa group server radius radius_aaa_1
switch config-sg-radius)# server 192.16.1.26
switch(config)#interface vlan 192
switch(config-if-vlan1)#ip address 192.16.1.50 255.255.255.0
switch(config)#free-resource 1 destination ipv4 192.16.1.26/32
```

2. Configure the portal function, portal server under the portal instance:

```
Switch (config)#captive-portal
Switch (config-cp)#enable
Switch(config-cp)# nas-ipv4 192.168.1.50
Switch(config-cp)# external portal-server server-name abc ipv4 172.16.1.26
Switch (config-cp)# configuration 1
Switch (config-cp-instance)#enable
Switch (config-cp-instance)#name helix4
Switch (config-cp-instance)#radius accounting
Switch (config-cp-instance)#radius-acct-server abc99
Switch (config-cp-instance)#radius-auth-server abc99
Switch (config-cp-instance)#redirect attribute nas-ip enable
Switch (config-cp-instance)#ac-name helix4
Switch (config-cp-instance)#redirect url-head http://172.16.1.26/a70.htm
Switch (config-cp-instance) # portal-server ipv4 abc
```

3. Configure the portal non-perception:

```
Switch (config-cp)#enable
Switch (config-cp)#fast-mac-auth
```

4. Enable the portal function on the port:

```
Switch (config)# interface ethernet1/0/2
Switch (config-if-ethernet1/0/2)#portal enable configuration 1
```

The normal portal authentication is needed in the first access. After the first time, user can use the non-perception authentication of portal.

7.16.7.4 Portal Non-perception Troubleshooting

Please check if the reasons are the following situations when there are problems in using the function of portal non-perception:

- ☞ Check whether the captive-portal function is enabled.
- ☞ Check whether the quick mac authentication function is enabled.
- ☞ Check whether issued the app table entry to the switch if the quick mac authentication is not effective after configured.

7.16.8 Portal Escaping

There is a risk in the current portal application. When the communication between the access device and portal server is broken, the new user cannot get on-line and the on-line user cannot get down; and the information of the access device and portal server is inconsistent. This will bring the accounting error. These phenomena can bring the inconvenience to the operations and users.

The portal escaping function provides a good method to solve the above problems. It can make the user on-line and use the network normally when the portal server or radius server cannot working normally, and the new user can still access the network. So the portal escaping includes portal server escaping and radius server escaping.

7.16.8.1 Portal Server Escaping

7.16.8.1.1 Introduction to Portal Server Escaping

The principle of portal server escaping function is that: switch probes the portal server periodically. If the probing is successful, the server status will be configured as UP; if the probing failed N times (N can be configured), it will change the status of unreachable to be DOWN (escaping status), cancel the network authentication limit, allow the portal user accessing the network without authentication and send the trap and log information of the status changing. When it probes the server is reachable, it will recover the server status to be UP (authentication status), restart the network authentication limit, reject the user without authentication accessing the network and send the log and trap information of the status recovering.

The method that switch probes the portal server status is probing the TCP connection: switch launches the TCP connection to the portal server port of the portal server (the default is 2000, it can be configured) regularly. If the connection is successful, it means that this portal server is enabled, we consider that the probing is successful and the server is reachable (the status is UP); if the connection failed, we consider the probing failed.

Probing interval and maximum number of probing failures: the interval of the probing can be configured through the command. The maximum number of probing failures means that the

probing failures before that the server is reachable. One probing failure does not mean that the server is unreachable; user should view if the number of the probing failures achieves the configured maximum value. If the number achieves the configured value, the server can be considered as unreachable; otherwise, the number is just cumulative. After probing is successful, this number will be cleared to be 0. The probing interval and maximum number of probing failures can be configured through the command.

The server triggers the following three configurations when the status changes from reachable to unreachable, the administrator can select through the configuration:

- Send trap: send the trap information to the network management server. In the trap, it records the portal server name and the status information before and after the change of the server status.
- Send log: send the log information to the log server. In the log, it records the portal server name and the status information before and after the change of the server status.
- permit-all: it is also named as portal escaping. It means to cancel the portal authentication temporarily and allow all the portal users accessing the network when the portal server is in the unreachable status (down).

The server triggers the following three configurations when the status changes from unreachable to reachable. “Send trap” and “send log” can be selected through the configuration; “Disable portal escaping” is enforced to carry on:

- Send trap: send the trap information to the network management server. In the trap, it records the portal server name and the status information before and after the change of the server status.
- Send log: send the log information to the log server. In the log, it records the portal server name and the status information before and after the change of the server status.
- Disable portal escaping: If the portal server status changes to the reachable status (up), the portal authentication function of VAP will be recovered. The new user must pass the portal authentication for accessing the network.

Notice: The portal escaping function can only achieve that the new and old users are not affected when accessing the network currently. For the situation that user cannot get down the line normally, there are other methods. For example, the portal server is recovered to be UP, the access device will enforce the user to get down the line and it ensure that user can get down the line normally.

7.16.8.1.2 Portal Escaping Configuration

Portal escaping function configuration task list:

1. Enable the Portal escaping function and configure the probing interval and maximum number of failures.
2. Show the current connection status of the Portal server.

1. Enable the Portal escaping function and configure the probing interval and maximum number of failures

Command	Explanation
Captive Portal Global Configuration Mode	
portal-server-detect server-name <name> [interval <interval>] [retry <retries>][action {log permit-all trap }] no portal-server-detect server-name <name>	Enable the Portal server escaping function and configure the related parameters (selectable) and the server configuration of status changing.

2. Show the current connection status of the Portal server

Command	Explanation
Admin Mode	
show captive-portal ext-portal-server server-name <name> status	Show the portal server status including the server address and if the portal escaping function is enabled.

7.16.8.1.3 Portal Escaping Examples

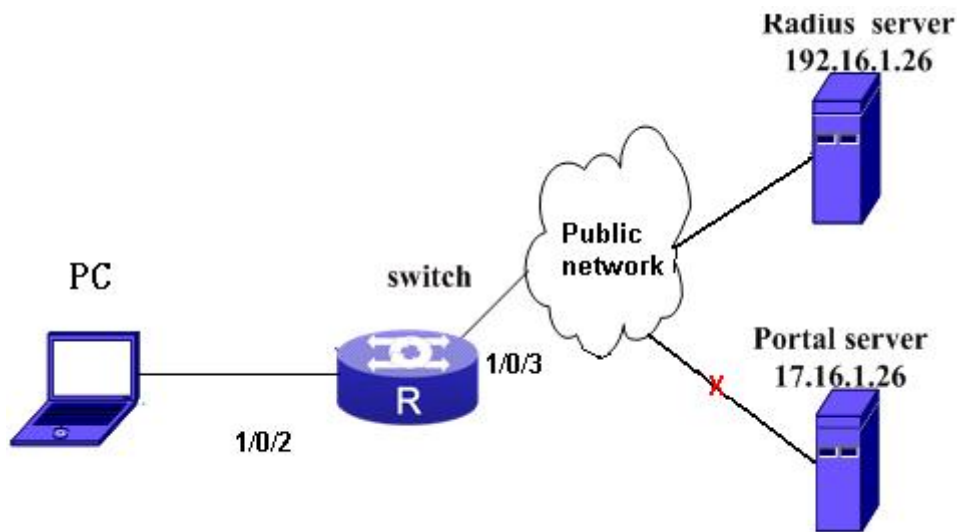

Figure 6-31 Portal server escaping function case

As shown above, in the situation of the normal working of portal server, the portal authentication can be normal for the network accessing when client is on-line. When the portal server is down or the connection between it and switch is broken, client cannot authenticate to on-line if the portal escaping function is not enabled on switch. If the portal escaping function is enabled on switch, switch can probe that the portal server is unavailable and start the portal escaping function. And the client can access the network without authentication. If client has passed the authentication before the portal server is broken, it will not be affected and it can still access the network.

The configuration is as below:

1. Configure the related authentication key, authentication server, accounting server and aaa

mode of the RADIUS server in global mode.

```
switch (config)#radius-server key 0 test
switch (config)#radius-server authentication host 192.16.1.26
switch (config)#radius-server accounting host 192.16.1.26
switch (config)#aaa-accounting enable
switch (config)#aaa enable
switch (config)#aaa group server radius radius_aaa_1
switch config-sg-radius)# server 192.16.1.26
switch(config)#interface vlan 192
switch(config-if-vlan1)#ip address 192.16.1.50 255.255.255.0
switch(config)#free-resource 1 destination ipv4 192.16.1.26/32
```

2. Configure the portal function, portal server under the portal instance:

```
Switch (config)#captive-portal
Switch (config-cp)#enable
Switch(config-cp)# nas-ipv4 192.168.1.50
Switch(config-cp)# external portal-server server-name abc ipv4 172.16.1.26
Switch (config-cp)# configuration 1
Switch (config-cp-instance)#enable
Switch (config-cp-instance)#name helix4
Switch (config-cp-instance)#radius accounting
Switch (config-cp-instance)#radius-acct-server abc99
Switch (config-cp-instance)#radius-auth-server abc99
Switch (config-cp-instance)#redirect attribute nas-ip enable
Switch (config-cp-instance)#ac-name helix4
Switch (config-cp-instance)#redirect url-head http://172.16.1.26/a70.htm
Switch (config-cp-instance) # portal-server ipv4 abc
```

3. Configure the portal escaping:

```
Switch (config-cp)#enable
Switch (config-cp)# portal-server-detect server-name abc interval 600 retry 2 action log permit-all
trap
```

4. Enable the portal function on the port:

```
Switch (config)# interface ethernet1/0/2
Switch (config-if-ethernet1/0/2)#portal enable configuration 1
```

As shown above, the portal server of cmcc is bound to CP instance and the probing function is configured; the probing interval is 600s. If the probing failed twice, send the trap information

and log of the unreachable server and the enable the portal escaping function to allow the user without authentication accessing the network.

7.16.8.1.4 Portal Escaping Troubleshooting

In using, please adopt the following methods if the portal escaping function cannot be effective.

- ☞ Use the command of **show captive-portal ext-portal-server server-name <name> status** to check if the detect mode of the portal server is “enable”. If it is not “enable”, it means that the portal server escaping function is not enabled, please enable it.
- ☞ If the portal escaping function is enabled, check if the Detect Operational Status is down. Only when the server status is down, the portal escaping function can be enabled.
- ☞ If the portal server status is down, and the escaping function cannot be effective, the device may have the problem. Please contact to the sales engineers.

7.16.8.2 Radius Server Escaping

7.16.8.2.1 Introduction to Radius Server Escaping

After enabled the radius server escaping function, the escaping function is effective when all the radius servers cannot achieve, and the traffic of the portal authentication client will be allowed. When the authentication server is detected achieving again, the allowing rule will be deleted.

7.16.8.2.2 Radius Server Escaping Configuration

Radius server escaping configuration task list:

1. Enable the radius server escaping function
2. Configure the detection interval of radius server

1. Enable the radius server escaping function

Command	Explanation
Global Mode	
radius-server escape {enable disable }	Enable the radius server escaping function.

2. Configure the detection interval of radius server

Command	Explanation
Global Mode	
radius-server escape detection-interval {default <second>}	Configure the detection interval of radius server and the default value is 180s.

7.16.8.2.3 Radius Server Escaping Examples

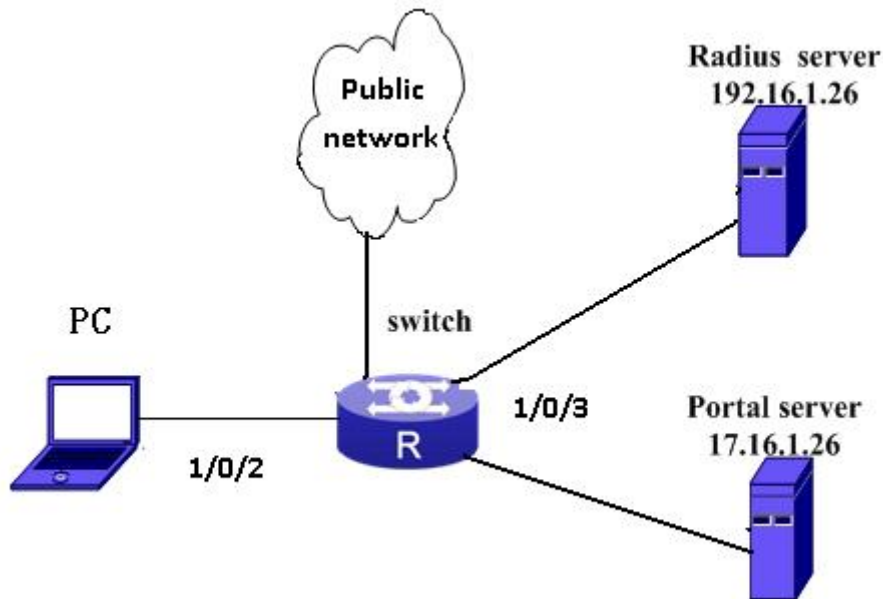

Figure 6-32 Radius server escaping case

The configuration is as below:

- 1 Configure the related authentication key, authentication server, accounting server and aaa mode of the RADIUS server in global mode.

```
switch (config)#radius-server key 0 test
switch (config)#radius-server authentication host 192.16.1.26
switch (config)#radius-server accounting host 192.16.1.26
switch (config)#aaa-accounting enable
switch (config)#aaa enable
switch (config)#aaa group server radius radius_aaa_1
switch config-sg-radius)# server 192.16.1.26
switch(config)#interface vlan 192
switch(config-if-vlan1)#ip address 192.16.1.50 255.255.255.0
switch(config)#free-resource 1 destination ipv4 192.16.1.26/32
```

- 2 Configure the portal function, portal server under the portal instance:

```
Switch (config)#captive-portal
Switch (config-cp)#enable
Switch(config-cp)# nas-ipv4 192.168.1.50
Switch(config-cp)# external portal-server server-name abc ipv4 172.16.1.26
Switch (config-cp)# configuration 1
Switch (config-cp-instance)#enable
Switch (config-cp-instance)#name helix4
Switch (config-cp-instance)#radius accounting
Switch (config-cp-instance)#radius-acct-server abc99
```

```
Switch (config-cp-instance)#radius-auth-server abc99
Switch (config-cp-instance)#redirect attribute nas-ip enable
Switch (config-cp-instance)#ac-name helix4
Switch (config-cp-instance)#redirect url-head http://172.16.1.26/a70.htm
Switch (config-cp-instance) # portal-server ipv4 abc
```

3 Configure the radius server escaping:

```
Switch (config)# radius-server escape enable
Switch (config)# radius-server escape detection-interval 120
```

4 Enable the portal function on the port:

```
Switch (config)# interface ethernet1/0/2
Switch (config-if-ethernet1/0/2)#portal enable configuration 1
```

The radius server is detected every 120s.

7.16.8.2.4 Radius Server Escaping Troubleshooting

If there are problems in using the radius server escaping function, please check it with the following steps:

- ☞ Check whether the radius server escaping function is enabled.
- ☞ If this function is enabled, get the parameters of Retransmit and Time Out by the command of **show aaa config** and then check whether if configured detection-interval is larger than the value of $(\text{Retransmit}+1)*\text{Time Out}$. If the detection-interval is smaller than it, the escaping function will fail.
- ☞ If the command of **show aaa config** shows Is Server live by radius escape function =0, it means the escaping is running but not effective. Please contact to the sales engineers.

7.17 MAB

7.17.1 Introduction to MAB

In actual network existing the device which can not install the authentication client, such as printer, PDA devices, they can not process 802.1x authentication. However, to access the network resources, they need to use MAB authentication to replace 802.1x authentication.

MAB authentication is a network accessing authentication method based on the accessing port and the MAC address of MAB user. The user needn't install any authentication client, after

the authentication device receives ARP packets sent by MAB user, it will authenticate the MAC address of the MAB user and there is the corresponding authentication information in the authentication server, the matched packets of the port and the source MAC are allowed to pass when the authentication is successful. MAB user didn't need to input the username and password manually in the process of authentication.

At present, MAB authentication device only supports RADIUS authentication method. There is the selection method for the authentication username and password: use the MAC address of the MAB user as the username and password, or the fixed username and password (all users use the configured username and password to authenticate).

7.17.2 MAB Configuration Task List

MAB Configuration Task List:

1. Enable MAB function
 - 1) Enable global MAB function
 - 2) Enable port MAB function
2. Configure MAB authentication username and password
3. Configure MAB parameters
 - 1) Configure guest-vlan
 - 2) Configure the binding-limit of the port
 - 3) Configure the reauthentication time
 - 4) Configure the offline detection time
 - 5) Configure other parameters

1. Enable MAB function

Command	Explanation
Global Mode	
mac-authentication-bypass enable no mac-authentication-bypass enable	Enable the global MAB authentication function.
Port Mode	
mac-authentication-bypass enable no mac-authentication-bypass enable	Enable the port MAB authentication function.

2. Configure MAB authentication username and password

Command	Explanation
Global Mode	
mac-authentication-bypass username-format {mac-address {fixed username WORD password WORD}}	Set the authentication mode of MAB authentication function.

3. Configure MAB parameters

Command	Explanation

Port Mode	
mac-authentication-bypass guest-vlan <1-4094> no mac-authentication-bypass guest-vlan	Set guset vlan of MAB authentication, only Hybrid port uses this command, it is not take effect on access port.
mac-authentication-bypass binding-limit <1-100> no mac-authentication-bypass binding-limit	Set the max MAB binding-limit of the port.
Global Mode	
mac-authentication-bypass timeout reauth-period <1-3600> no mac-authentication-bypass timeout reauth-period	Set the reauthentication interval after the authentication is unsuccessful.
mac-authentication-bypass timeout offline-detect (0 <60-7200>) no mac-authentication-bypass timeout offline-detect	Set offline detection interval.
mac-authentication-bypass timeout quiet-period <1-60> no mac-authentication-bypass timeout quiet-period	Set quiet-period of MAB authentication.
mac-authentication-bypass timeout stale-period <0-60> no mac-authentication-bypass timeout stale-period	Set the time that delete the binding after the port is down.
mac-authentication-bypass timeout linkup-period <0-30> no mac-authentication-bypass timeout linkup-period	To obtain IP again, set the interval of down/up when MAB binding is changing into VLAN.
authentication mab {radius local} (none) no authentication mab	Configure the authentication mode and priority of MAC address, the no command restores the default authentication mode.

7.17.3 MAB Example

Example:

The typical example of MAB authentication function:

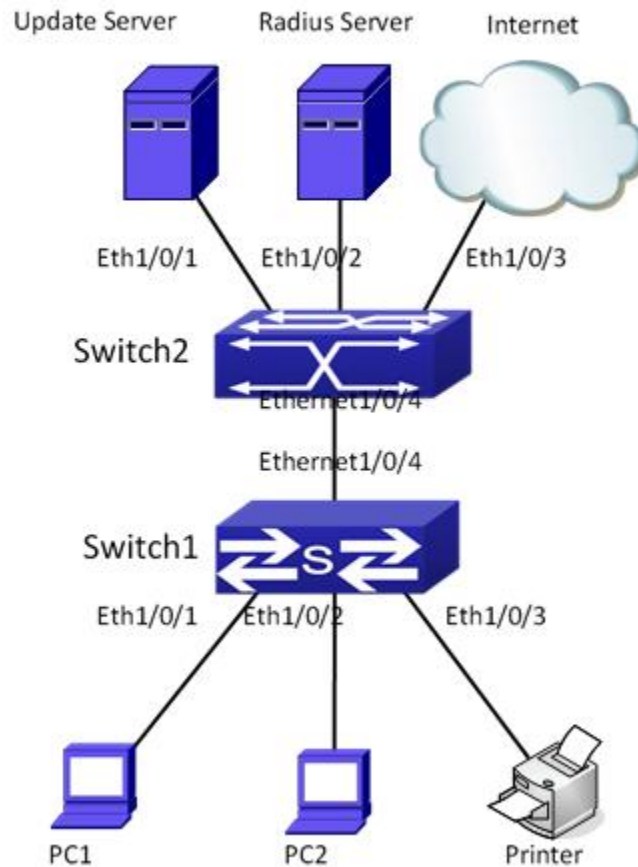

Figure 6-33 MAB application

Switch1 is a layer 2 accessing switch, Switch2 is a layer 3 aggregation switch.

Ethernet 1/0/1 is an access port of Switch1, connects to PC1, it enables 802.1x port-based function and configures guest vlan as vlan8.

Ethernet 1/0/2 is a hybrid port, connects to PC2, native vlan of the port is vlan1, and configures guest vlan as vlan8, it joins in vlan1, vlan8 and vlan10 with untag method and enables MAB function.

Ethernet 1/0/3 is an access port, connects to the printer and enables MAB function.

Ethernet 1/0/4 is a trunk port, connects to Switch2.

Ethernet 1/0/4 is a trunk port of Switch2, connects to Switch1.

Ethernet 1/0/1 is an access port, belongs to vlan8, connects to update server to download and upgrade the client software.

Ethernet 1/0/2 is an access port, belongs to vlan9, connects to radius server which configure auto vlan as vlan10.

Ethernet 1/0/3 is an access port, belongs to vlan10, connects to external internet resources.

To implement this application, the configuration is as follows:

Switch1 configuration:

- (1) Enable 802.1x and MAB authentication function globally, configure username and password of MAB authentication and radius-server address

```
Switch(config)# dot1x enable
Switch(config)# mac-authentication-bypass enable
Switch(config)# mac-authentication-bypass username-format fixed username mabuser password mabpwd
Switch(config)# vlan 8-10
Switch(config)# interface vlan 9
Switch(config-if-vlan9) ip address 192.168.61.9 255.255.255.0
Switch(config-if-vlan9) exit
Switch(config)# radius-server authentication host 192.168.61.10
Switch(config)# radius-server accounting host 192.168.61.10
Switch(config)# radius-server key test
Switch(config)# aaa enable
Switch(config)# aaa-accounting enable
```

- (2) Enable the authentication function of each port

```
Switch(config)# interface ethernet 1/0/1
Switch(config-if-ethernet1/0/1)# dot1x enable
Switch(config-if-ethernet1/0/1)# dot1x port-method portbased
Switch(config-if-ethernet1/0/1)# dot1x guest-vlan 8
Switch(config-if-ethernet1/0/1)# exit

Switch(config)# interface ethernet 1/0/2
Switch(config-if-ethernet1/0/2)# switchport mode hybrid
Switch(config-if-ethernet1/0/2)# switchport hybrid native vlan 1
Switch(config-if-ethernet1/0/2)# switchport hybrid allowed vlan 1;8;10 untag
Switch(config-if-ethernet1/0/2)# mac-authentication-bypass enable
Switch(config-if-ethernet1/0/2)# mac-authentication-bypass enable guest-vlan 8
Switch(config-if-ethernet1/0/2)# exit

Switch(config)# interface ethernet 1/0/3
Switch(config-if-ethernet1/0/3)# switchport mode access
Switch(config-if-ethernet1/0/3)# mac-authentication-bypass enable
Switch(config-if-ethernet1/0/3)# exit

Switch(config)# interface ethernet 1/0/4
Switch(config-if-ethernet1/0/4)# switchport mode trunk
```

7.17.4 MAB Troubleshooting

If there is any problem happens when using MAB function, please check whether the problem is caused by the following reasons:

- ✎ Make sure global and port MAB function are enabled;
- ✎ Make sure the correct username and password of MAB authentication are used;
- ✎ Make sure the radius-server configuration is correct. Complete MAB offline-detect through query whether dynamic MAC is exist. Do not delete the binding if the MAC address exists in MAC address table. The actual offline time without the traffic is 1-2 MAC aging period add 0-1 MAB offline-detect time.

Chapter 8 Reliability Configuration

8.1 MSTP

8.1.1 Introduction to MSTP

The MSTP (Multiple STP) is a new spanning-tree protocol which is based on the STP and the RSTP. It runs on all the bridges of a bridged-LAN. It calculates a common and internal spanning tree (CIST) for the bridge-LAN which consists of the bridges running the MSTP, the RSTP and the STP. It also calculates the independent multiple spanning-tree instances (MSTI) for each MST domain (MSTP domain). The MSTP, which adopts the RSTP for its rapid convergence of the spanning tree, enables multiple VLANs to be mapped to the same spanning-tree instance which is independent to other spanning-tree instances. The MSTP provides multiple forwarding paths for data traffic and enables load balancing. Moreover, because multiple VLANs share a same MSTI, the MSTP can reduce the number of spanning-tree instances, which consumes less CPU resources and reduces the bandwidth consumption.

8.1.1.1 MSTP Region

Because multiple VLANs can be mapped to a single spanning tree instance, IEEE 802.1s committee raises the MST concept. The MST is used to make the association of a certain VLAN to a certain spanning tree instance.

A MSTP region is composed of one or multiple bridges with the same MCID (MST Configuration Identification) and the bridged-LAN (a certain bridge in the MSTP region is the designated bridge of the LAN, and the bridges attaching to the LAN are not running STP). All the bridges in the same MSTP region have the same MSID.

MSID consists of 3 attributes:

- ↳ Configuration Name: Composed by digits and letters
- ↳ Revision Level
- ↳ Configuration Digest: VLANs mapping to spanning tree instances

The bridges with the same 3 above attributes are considered as in the same MST region.

When the MSTP calculates CIST in a bridged-LAN, a MSTP region is considered as a bridge. See the figure below:

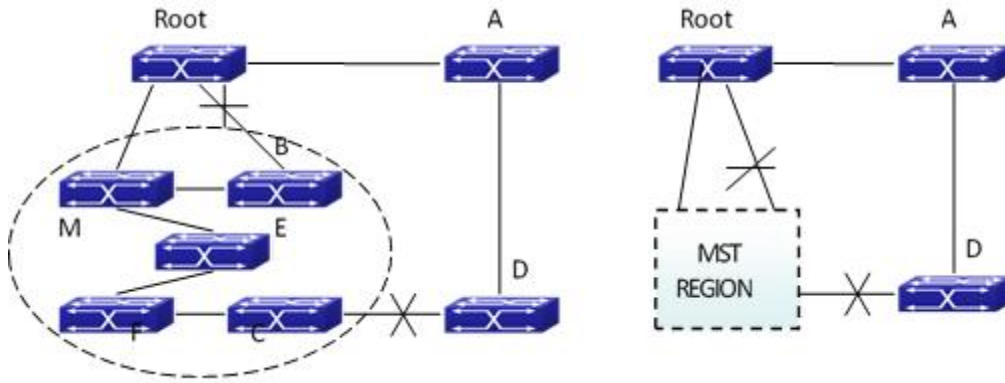

Figure 7-1 Example of CIST and MST Region

In the above network, if the bridges are running the STP or the RSTP, one port between Bridge M and Bridge B should be blocked. But if the bridges in the yellow range run the MSTP and are configured in the same MST region, MSTP will treat this region as a bridge. Therefore, one port between Bridge B and Root is blocked and one port on Bridge D is blocked.

8.1.1.1.1 Operations within an MSTP Region

The IST connects all the MSTP bridges in a region. When the IST converges, the root of the IST becomes the IST master, which is the switch within the region with the lowest bridge ID and path cost to the CST root. The IST master is also the CST root if there is only one region within the network. If the CST root is outside the region, one of the MSTP bridges at the boundary of the region is selected as the IST master.

When an MSTP bridge initializes, it sends BPDUs claiming itself as the root of the CST and the IST master, with both of the path costs to the CST root and to the IST master set to zero. The bridge also initializes all of its MST instances and claims to be the root for all of them. If the bridge receives superior MST root information (lower bridge ID, lower path cost, and so forth) than currently stored for the port, it relinquishes its claim as the IST master.

Within a MST region, the IST is the only spanning-tree instance that sends and receives BPDUs. Because the MST BPDU carries information for all instances, the number of BPDUs that need to be processed by a switch to support multiple spanning-tree instances is significantly reduced.

All MST instances within the same region share the same protocol timers, but each MST instance has its own topology parameters, such as root switch ID, root path cost, and so forth.

8.1.1.1.2 Operations between MST Regions

If there are multiple regions or legacy 802.1D bridges within the network, MSTP establishes and maintains the CST, which includes all MST regions and all legacy STP bridges in the network. The MST instances combine with the IST at the boundary of the region to become the CST.

The MSTI is only valid within its MST region. An MSTI has nothing to do with MSTIs in other MST regions. The bridges in a MST region receive the MST BPDU of other regions through Boundary Ports. They only process CIST related information and abandon MSTI information.

8.1.1.2 Port Roles

The MSTP bridge assigns a port role to each port which runs MSTP.

- 👉 CIST port roles: Root Port, Designated Port, Alternate Port and Backup Port
- 👉 On top of those roles, each MSTI port has one new role: Master Port.

The port roles in the CIST (Root Port, Designated Port, Alternate Port and Backup Port) are defined in the same ways as those in the RSTP.

8.1.1.3 MSTP Load Balance

In a MSTP region, VLANs can be mapped to various instances. That can form various topologies. Each instance is independent from the others and each instance can have its own attributes such as bridge priority and port cost etc. Consequently, the VLANs in different instances have their own paths. The traffic of the VLANs are load-balanced.

8.1.2 MSTP Configuration Task List

MSTP configuration task list:

1. Enable the MSTP and set the running mode
2. Configure instance parameters
3. Configure MSTP region parameters
4. Configure MSTP time parameters
5. Configure the fast migrate feature for MSTP
6. Configure the format of port packet
7. Configure the spanning-tree attribute of port
8. Configure the snooping attribute of authentication key
9. Configure the FLUSH mode once topology changes

1. Enable MSTP and set the running mode

Command	Explanation
Global Mode and Port Mode	
spanning-tree no spanning-tree	Enable/Disable MSTP.
Global Mode	
spanning-tree mode {mstp stp rstp} no spanning-tree mode	Set MSTP running mode.
Port Mode	
spanning-tree mcheck	Force port migrate to run under MSTP.

2. Configure instance parameters

Command	Explanation
Global Mode	
spanning-tree mst <instance-id> priority	Set bridge priority for specified instance.

<bridge-priority> no spanning-tree mst <instance-id> priority	
spanning-tree priority <bridge-priority> no spanning-tree priority	Configure the spanning-tree priority of the switch.
Port Mode	
spanning-tree mst <instance-id> cost <cost> no spanning-tree mst <instance-id> cost	Set port path cost for specified instance.
spanning-tree mst <instance-id> port-priority <port-priority> no spanning-tree mst <instance-id> port-priority	Set port priority for specified instance.
spanning-tree mst <instance-id> rootguard no spanning-tree mst <instance-id> rootguard	Configure currently port whether running rootguard in specified instance, configure the rootguard port can't turn to root port.
spanning-tree rootguard no spanning-tree rootguard	Configure currently port whether running rootguard in instance 0, configure the rootguard port can't turn to root port.
spanning-tree [mst <instance-id>] loopguard no spanning-tree [mst <instance-id>] loopguard	Enable loopguard function on specified instance, the no command disables this function.

3. Configure MSTP region parameters

Command	Explanation
Global Mode	
spanning-tree mst configuration no spanning-tree mst configuration	Enter MSTP region mode. The no command restores the default setting.
MSTP region mode	
show	Display the information of the current running system.
instance <instance-id> vlan <vlan-list> no instance <instance-id> [vlan <vlan-list>]	Create Instance and set mapping between VLAN and Instance.
name <name> no name	Set MSTP region name.
revision-level <level> no revision-level	Set MSTP region revision level.
abort	Quit MSTP region mode and return to Global mode without saving MSTP region configuration.
exit	Quit MSTP region mode and return to Global mode with saving MSTP region

	configuration.
no	Cancel one command or set initial value.

4. Configure MSTP time parameters

Command	Explanation
Global Mode	
spanning-tree forward-time <time> no spanning-tree forward-time	Set the value for switch forward delay time.
spanning-tree hello-time <time> no spanning-tree hello-time	Set the Hello time for sending BPDU messages.
spanning-tree maxage <time> no spanning-tree maxage	Set Aging time for BPDU messages.
spanning-tree max-hop <hop-count> no spanning-tree max-hop	Set Maximum number of hops of BPDU messages in the MSTP region.

5. Configure the fast migrate feature for MSTP

Command	Explanation
Port Mode	
spanning-tree link-type p2p {auto force-true force-false} no spanning-tree link-type	Set the port link type.
spanning-tree portfast [bpdufilter bpduguard] [recovery <30-3600>] no spanning-tree portfast	Set and cancel the port to be an boundary port. bpdufilter receives the BPDU discarding; bpduguard receives the BPDU will disable port; no parameter receives the BPDU, the port becomes a non-boundary port.

6. Configure the format of MSTP

Command	Explanation
Port Mode	
spanning-tree format standard spanning-tree format privacy spanning-tree format auto no spanning-tree format	Configure the format of port spanning-tree packet, standard format is provided by IEEE, privacy is compatible with CISCO and auto means the format is determined by checking the received packet.

7. Configure the spanning-tree attribute of port

Command	Explanation
Port Mode	
spanning-tree cost no spanning-tree cost	Set the port path cost.

spanning-tree port-priority no spanning-tree port-priority	Set the port priority.
spanning-tree rootguard no spanning-tree rootguard	Set the port is root port.
Global Mode	
spanning-tree transmit-hold-count <i><tx-hold-count-value></i> no spanning-tree transmit-hold-count	Set the max transmit-hold-count of port.
spanning-tree cost-format {dot1d dot1t}	Set port cost format with dot1d or dot1t.

8. Configure the snooping attribute of authentication key

Command	Explanation
Port Mode	
spanning-tree digest-snooping no spanning-tree digest-snooping	Set the port to use the authentication string of partner port. The no command restores to use the generated string.

9. Configure the FLUSH mode once topology changes

Command	Explanation
Global Mode	
spanning-tree tflush {enable disable protect} no spanning-tree tflush	Enable: the spanning-tree flush once the topology changes. Disable: the spanning tree don't flush when the topology changes. Protect: the spanning-tree flush not more than one time every ten seconds. The no command restores to default setting, enable flush once the topology changes.
Port Mode	
spanning-tree tflush {enable disable protect} no spanning-tree tflush	Configure the port flush mode. The no command restores to use the global configured flush mode.

8.1.3 MSTP Example

The following is a typical MSTP application example:

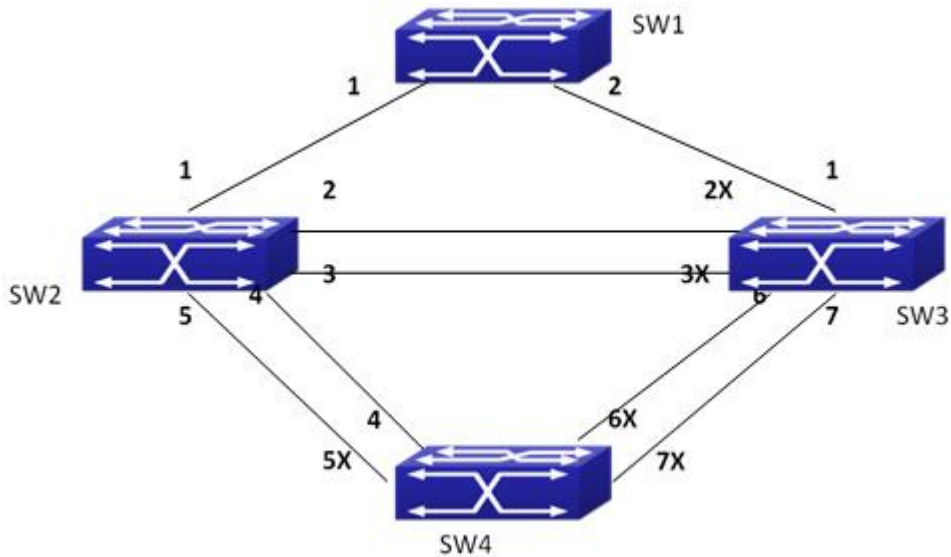

Figure 7-2 Typical MSTP Application Scenario

The connections among the switches are shown in the above figure. All the switches run in the MSTP mode by default, their bridge priority, port priority and port route cost are all in the default values (equal). The default configuration for switches is listed below:

Bridge Name	SW1	SW2	SW3	SW4	
Bridge MAC Address	...00-00-01	...00-00-02	...00-00-03	...00-00-04	
Bridge Priority	32768	32768	32768	32768	
Port Priority	port 1	128	128		
	port 2	128	128		
	port 3		128	128	
	port 4		128		128
	port 5		128		128
	port 6			128	128
	port 7			128	128
Route Cost	port 1	200000	200000		
	port 2	200000	200000		
	port 3		200000	200000	
	port 4		200000		200000
	port 5		200000		200000
	port 6			200000	200000
	port 7			200000	200000

By default, the MSTP establishes a tree topology (in blue lines) rooted with SwitchA. The ports marked with “x” are in the discarding status, and the other ports are in the forwarding status.

Configurations Steps:

Step 1: Configure port to VLAN mapping:

- ✎ Create VLAN 20, 30, 40, 50 in Switch2, Switch3 and Switch4.

- ✎ Set ports 1-7 as trunk ports in Switch2 Switch3 and Switch4.

Step 2: Set Switch2, Switch3 and Switch4 in the same MSTP:

- ✎ Set Switch2, Switch3 and Switch4 to have the same region name as mstp.

- ✎ Map VLAN 20 and VLAN 30 in Switch2, Switch3 and Switch4 to Instance 3; Map VLAN 40 and VLAN 50 in Switch2, Switch3 and Switch4 to Instance 4.

Step 3: Set Switch3 as the root bridge of Instance 3; Set Switch4 as the root bridge of Instance 4

- ✎ Set the bridge priority of Instance 3 in Switch3 as 0.

- ✎ Set the bridge priority of Instance 4 in Switch4 as 0.

The detailed configuration is listed below:

Switch2:

```
Switch2(config)#vlan 20
Switch2(Config-Vlan20)#exit
Switch2(config)#vlan 30
Switch2(Config-Vlan30)#exit
Switch2(config)#vlan 40
Switch2(Config-Vlan40)#exit
Switch2(config)#vlan 50
Switch2(Config-Vlan50)#exit
Switch2(config)#spanning-tree mst configuration
Switch2(Config-Mstp-Region)#name mstp
Switch2(Config-Mstp-Region)#instance 3 vlan 20;30
Switch2(Config-Mstp-Region)#instance 4 vlan 40;50
Switch2(Config-Mstp-Region)#exit
Switch2(config)#interface e1/0/1-7
Switch2(Config-Port-Range)#switchport mode trunk
Switch2(Config-Port-Range)#exit
Switch2(config)#spanning-tree
```

Switch3:

```
Switch3(config)#vlan 20
Switch3(Config-Vlan20)#exit
Switch3(config)#vlan 30
Switch3(Config-Vlan30)#exit
Switch3(config)#vlan 40
Switch3(Config-Vlan40)#exit
Switch3(config)#vlan 50
Switch3(Config-Vlan50)#exit
Switch3(config)#spanning-tree mst configuration
Switch3(Config-Mstp-Region)#name mstp
Switch3(Config-Mstp-Region)#instance 3 vlan 20;30
```

```
Switch3(Config-Mstp-Region)#instance 4 vlan 40;50
Switch3(Config-Mstp-Region)#exit
Switch3(config)#interface e1/0/1-7
Switch3(Config-Port-Range)#switchport mode trunk
Switch3(Config-Port-Range)#exit
Switch3(config)#spanning-tree
Switch3(config)#spanning-tree mst 3 priority 0
```

Switch4:

```
Switch4(config)#vlan 20
Switch4(Config-Vlan20)#exit
Switch4(config)#vlan 30
Switch4(Config-Vlan30)#exit
Switch4(config)#vlan 40
Switch4(Config-Vlan40)#exit
Switch4(config)#vlan 50
Switch4(Config-Vlan50)#exit
Switch4(config)#spanning-tree mst configuration
Switch4(Config-Mstp-Region)#name mstp
Switch4(Config-Mstp-Region)#instance 3 vlan 20;30
Switch4(Config-Mstp-Region)#instance 4 vlan 40;50
Switch4(Config-Mstp-Region)#exit
Switch4(config)#interface e1/0/1-7
Switch4(Config-Port-Range)#switchport mode trunk
Switch4(Config-Port-Range)#exit
Switch4(config)#spanning-tree
Switch4(config)#spanning-tree mst 4 priority 0
```

After the above configuration, Switch1 is the root bridge of the instance 0 of the entire network. In the MSTP region which Switch2, Switch3 and Switch4 belong to, Switch2 is the region root of the instance 0, Switch3 is the region root of the instance 3 and Switch4 is the region root of the instance 4. The traffic of VLAN 20 and VLAN 30 is sent through the topology of the instance 3. The traffic of VLAN 40 and VLAN 50 is sent through the topology of the instance 4. And the traffic of other VLANs is sent through the topology of the instance 0. The port 1 in Switch2 is the master port of the instance 3 and the instance 4.

The MSTP calculation generates 3 topologies: the instance 0, the instance 3 and the instance 4 (marked with blue lines). The ports with the mark “x” are in the status of discarding. The other ports are the status of forwarding. Because the instance 3 and the instance 4 are only valid in the MSTP region, the following figure only shows the topology of the MSTP region.

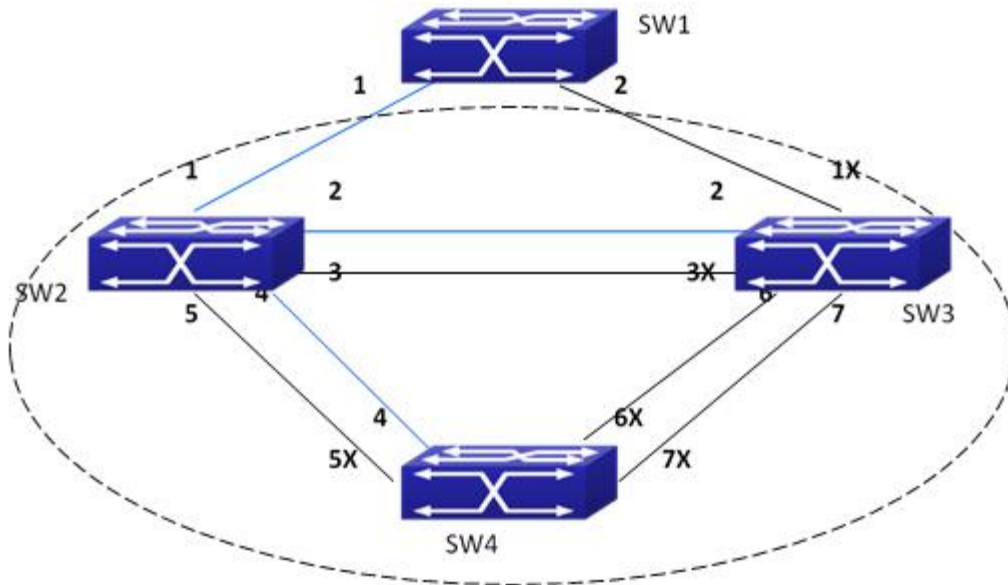

Figure 7-3 The Topology Of the Instance 0 after the MSTP Calculation

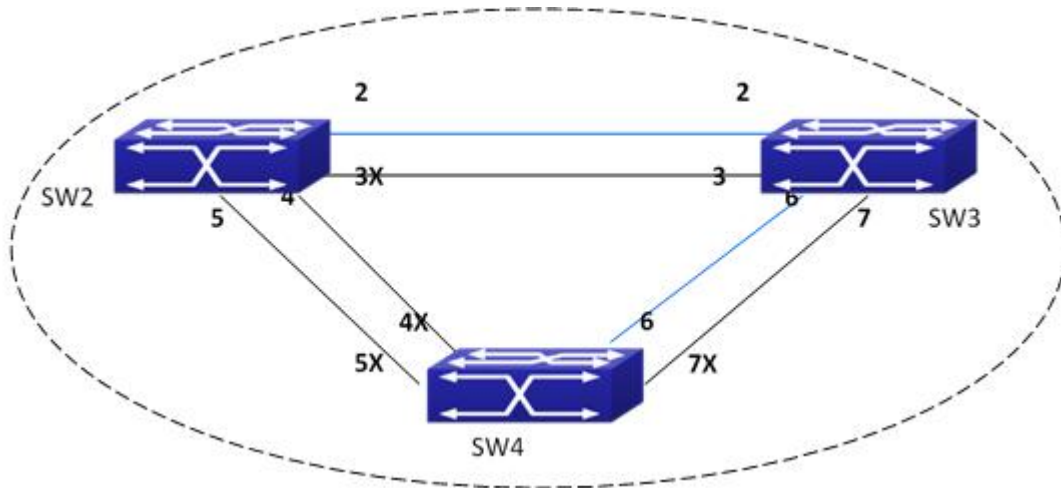

Figure 7-4 The Topology Of the Instance 3 after the MSTP Calculation

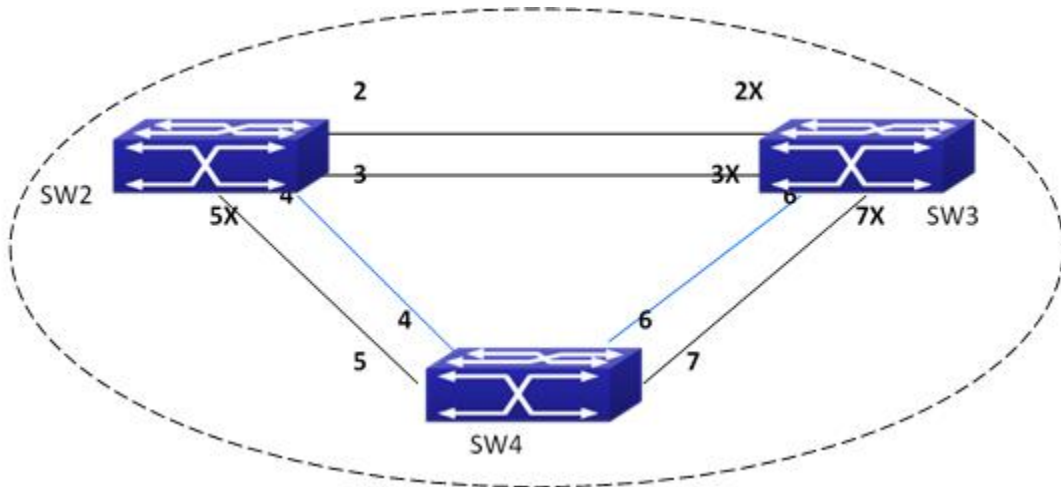

Figure 7-5 The Topology Of the Instance 4 after the MSTP Calculation

8.1.4 MSTP Troubleshooting

- 👉 In order to run the MSTP on the switch port, the MSTP has to be enabled globally. If the MSTP is not enabled globally, it can't be enabled on the port.
- 👉 The MSTP parameters co work with each other, so the parameters should meet the following conditions. Otherwise, the MSTP may work incorrectly.
 - $2 \times (\text{Bridge_Forward_Delay} - 1.0 \text{ seconds}) \geq \text{Bridge_Max_Age}$
 - $\text{Bridge_Max_Age} \geq 2 \times (\text{Bridge_Hello_Time} + 1.0 \text{ seconds})$
- 👉 When users modify the MSTP parameters, they have to be sure about the changes of the topologies. The global configuration is based on the bridge. Other configurations are based on the individual instances.

8.2 VRRP

8.2.1 Introduction to VRRP

VRRP (Virtual Router Redundancy Protocol) is a fault tolerant protocol designed to enhance connection reliability between routers (or L3 Ethernet switches) and external devices. It is developed by the IETF for local area networks (LAN) with multicast/broadcast capability (Ethernet is a Configuration Example) and has wide applications.

All hosts in one LAN generally have a default route configured to specified default gateway, any packet destined to an address outside the native segment will be sent to the default gateway via this default route. These hosts in the LAN can communicate with the external networks. However, if the communication link connecting the router serving as default gateway and external networks fails, all hosts using that gateway as the default next hop route will be unable to communicate with the external networks.

VRRP emerged to resolve such problem. VRRP runs on multiple routers in a LAN, simulating a "virtual" router (also referred to as a "Standby cluster") with the multiple routes. There is an active router (the "Master") and one or more backup routers (the "Backup") in the Standby cluster. The workload of the virtual router is actually undertaken by the active router, while the Backup routers serve as backups for the active router.

The virtual router has its own "virtual" IP address (can be identical with the IP address of some router in the Standby cluster), and routers in the Standby cluster also have their own IP address. Since VRRP runs on routes or Ethernet Switches only, the Standby cluster is transparent to the hosts with the segment. To them, there exists only the IP address of the Virtual Router instead of the actual IP addresses of the Master and Backup(s). And the default gateway setting of all the hosts uses the IP address of the Virtual Router. Therefore, hosts within the LAN communicate with the other networks via this Virtual Router. But basically, they are communicating with the other networks via the Master. In the case when the Master of the Standby cluster fails, a backup will take over its task and become the Master to serve all the hosts in the LAN, so that uninterrupted communication between LAN hosts and external networks can be achieved.

To sum it up, in a VRRP Standby cluster, there is always a router/Ethernet serving as the active router (Master), while the rest of the Standby cluster servers act as the backup router(s) (Backup, can be multiple) and monitor the activity of Master all the time. Should the Master fail, a new Master will be elected by all the Backups to take over the work and continue serving the hosts within the segment. Since the election and take-over duration is brief and smooth, hosts within the segment can use the Virtual Router as normal and uninterrupted communication can be achieved.

8.2.2 VRRP Configuration Task List

Configuration Task List:

1. Create/Remove the Virtual Router (required)

2. Configure VRRP dummy IP and interface (required)
3. Activate/Deactivate Virtual Router (required)
4. Configure VRRP sub-parameters (optional)
 - (1) Configure the preemptive mode for VRRP
 - (2) Configure VRRP priority
 - (3) Configure VRRP Timer intervals
 - (4) Configure VRRP interface monitor
 - (5) Configure the status of the VRRP session monitor port
 - (6) Configure VRRP authenticationss

1. Create/Remove the Virtual Router

Command	Explanation
Global Mode	
router vrrp <vrid> no router vrrp <vrid>	Creates/Removes the Virtual Router.

2. Configure VRRP Dummy IP Address and Interface

Command	Explanation
VRRP protocol configuration mode	
virtual-ip <ip> no virtual-ip	Configures VRRP Dummy IP address; the " no virtual-ip " command removes the virtual IP address.
interface {IFNAME Vlan <ID>} no interface	Configures VRRP interface, the " no interface " command removes the interface.

3. Activate/Deactivate Virtual Router

Command	Explanation
VRRP protocol configuration mode	
enable	Activates the Virtual Router.
disable	Deactivates the Virtual Router.

4. Configure VRRP Sub-parameters

- (1) Configure the preemptive mode for VRRP

Command	Explanation
VRRP protocol configuration mode	
preempt-mode {true false}	Configures the preemptive mode for VRRP.

- (2) Configure VRRP priority

Command	Explanation
VRRP protocol configuration mode	
priority <priority>	Configures VRRP priority.

(3) Configure VRRP Timer intervals

Command	Explanation
VRRP protocol configuration mode	
advertisement-interval <time>	Configures VRRP timer value (in seconds).

(4) Configure VRRP interface monitor

Command	Explanation
VRRP protocol configuration mode	
circuit-failover {IFNAME Vlan <ID> } <value_reduced> no circuit-failover	Configures VRRP interface monitor, the " no circuit-failover " removes monitor to the interface.

(5) Configure the status of the VRRP session monitor port

Command	Explanation
VRRP protocol configuration mode	
vrp track interface {ethernet IFNAME IFNAME} priority <priority_value> no vrrp track interface {ethernet IFNAME IFNAME}	Configure the status of the VRRP session monitor port.

(6) Configure VRRP authentications

Command	Explanation
VRRP protocol configuration mode	
authentication string {0 7} <string> no authentication	Configure VRRP authentication information. The " no authentication " is used to restore default settings.

8.2.3 VRRP Typical Examples

As shown in the figure below, SwitchA and SwitchB are Layer three Ethernet Switches in the same group and provide redundancy for each other.

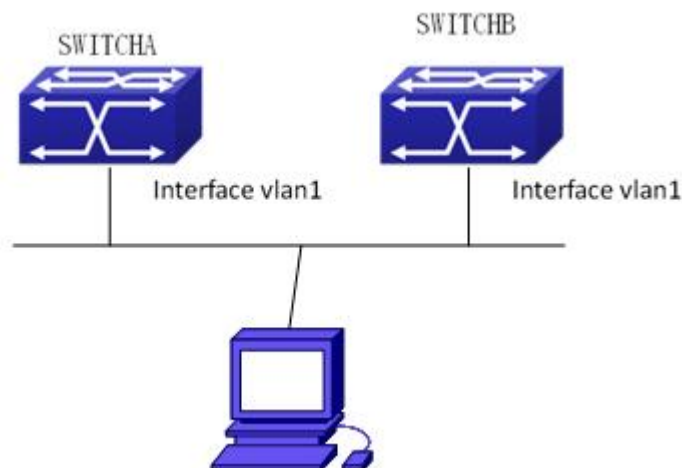

Figure 7-6 VRRP Network Topology

Configuration of SwitchA:

```
SwitchA(config)#interface vlan 1
SwitchA (Config-if-Vlan1)# ip address 10.1.1.1 255.255.255.0
SwitchA (config)#router vrrp 1
SwitchA(Config-Router-Vrrp)# virtual-ip 10.1.1.5
SwitchA(Config-Router-Vrrp)# interface vlan 1
SwitchA(Config-Router-Vrrp)# enable
```

Configuration of SwitchB:

```
SwitchB(config)#interface vlan 1
SwitchB (Config-if-Vlan1)# ip address 10.1.1.7 255.255.255.0
SwitchB(config)#router vrrp 1
SwitchB (Config-Router-Vrrp)# virtual-ip 10.1.1.5
SwitchB(Config-Router-Vrrp)# interface vlan 1
SwitchB(Config-Router-Vrrp)# enable
```

8.2.4 VRRP Troubleshooting

In configuring and using VRRP protocol, the VRRP protocol may fail to run properly due to reasons such as physical connection failure or wrong configurations. The user should ensure the following:

- ☞ Good condition of the physical connection.
- ☞ All interface and link protocols are in the UP state (use “**show interface**” command).
- ☞ Ensure VRRP is enabled on the interface. Verify the authentication mode of different routers (or L3 Ethernet switches) in the same standby cluster are the same.
- ☞ Verify the timer time of different routers (or L3 Ethernet switches) in the same standby cluster are the same.
- ☞ Verify the dummy IP address is in the same network segment of the interface’s actual IP address.
- ☞ If the examination remains unsolved, please use **debug vrrp** and other debugging command and copy the DEBUG message within 3 minutes, send the recorded message to the technical server center of our company.

8.3 MRPP

8.3.1 Introduction to MRPP

MRPP (Multi-layer Ring Protection Protocol), is a link layer protocol applied on Ethernet

loop protection. It can avoid broadcast storm caused by data loop on Ethernet ring, and restore communication among every node on ring network when the Ethernet ring has a break link. MRPP is the expansion of EAPS (Ethernet link automatic protection protocol).

MRPP protocol is similar to STP protocol on function, MRPP has below characters, compare to STP protocol:

- <1> MRPP specifically uses to Ethernet ring topology
- <2> fast convergence, less than 1 s. ideally it can reach 100-50 ms.

8.3.1.1 Conception Introduction

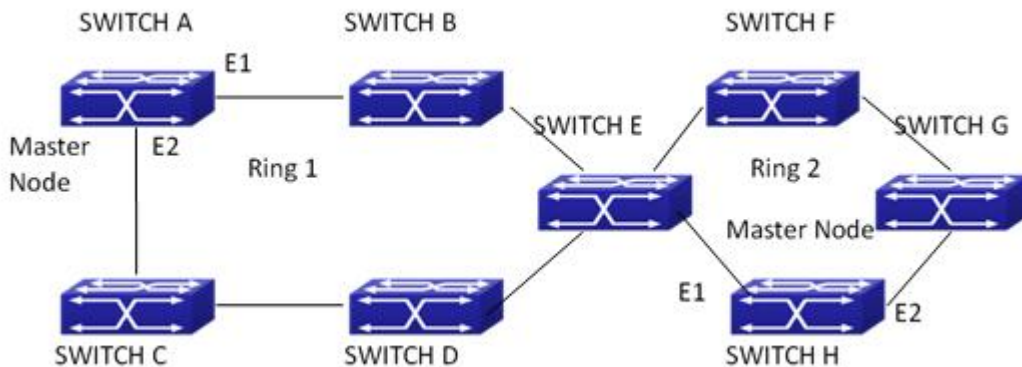

Figure 7-7 MRPP Sketch Map

1. Control VLAN

Control VLAN is a virtual VLAN, only used to identify MRPP protocol packet transferred in the link. To avoid confusion with other configured VLAN, avoids configuring control VLAN ID to be the same with other configured VLAN ID. The different MRPP ring should configure the different control VLAN ID.

2. Ethernet Ring (MRPP Ring)

Ring linked Ethernet network topology.

Each MRPP ring has two states.

Health state: The whole ring network physical link is connected.

Break state: one or a few physical link break in ring network

3. nodes

Each switch is named after a node on Ethernet. The node has some types:

Primary node: each ring has a primary node, it is main node to detect and defend.

Transfer node: except for primary node, other nodes are transfer nodes on each ring.

The node role is determined by user configuration. As shown Fig 3-1, Switch A is primary node of Ring 1, Switch B, Switch C; Switch D and Switch E are transfer nodes of Ring 1.

4. Primary port and secondary port

The primary node and transfer node have two ports connecting to Ethernet separately, one is primary port, and another is secondary port. The role of port is determined by user configuration.

Primary port and secondary port of primary node.

The primary port of primary node is used to send ring health examine packet (hello), the secondary port is used to receive Hello packet sending from primary node. When the Ethernet is in health state, the secondary port of primary node blocks other data in logical and only MRPP packet can pass. When the Ethernet is in break state, the secondary port of primary node releases block state, and forwards data packets.

There are no difference on function between Primary port and secondary port of transfer node.

The role of port is determined by user configuration. As shown Fig 3-1, Switch A E1 is primary port, E2 is secondary port.

5. Timer

The two timers are used when the primary node sends and receives MRPP protocol packet: Hello timer and Fail Timer.

Hello timer: define timer of time interval of health examine packet sending by primary node primary port.

Fail timer: define timer of overtime interval of health examine packet receiving by primary node primary port. The value of Fail timer must be more than or equal to the 3 times of value of Hello timer.

8.3.1.2 MRPP Protocol Packet Types

Packet Type	Explanation
Hello packet (Health examine packet) Hello	The primary port of primary node evokes to detect ring, if the secondary port of primary node can receive Hello packet in configured overtime, so the ring is normal.
LINK-DOWN (link Down event packet)	After transfer node detects Down event on port, immediately sends LINK-DOWN packet to primary node, and inform primary node ring to fail.
LINK-DOWN-FLUSH_FDB packet	After primary node detects ring failure or receives LINK-DOWN packet, open blocked secondary port, and then uses two ports to send the packet, to inform each transfer node to refresh own MAC address.
LINK-UP-FLUSH_FDB packet	After primary detects ring failure to restore normal, and uses packet from primary port, and informs each transfer node to refresh own MAC address.

8.3.1.3 MRPP Protocol Operation System

1. Link Down Alarm System

When transfer node finds themselves belonging to MRPP ring port Down, it sends link Down packet to primary node immediately. The primary node receives link down packet and immediately releases block state of secondary port, and sends LINK-DOWN-FLUSH-FDB packet to inform all of transfer nodes, refreshing own MAC address forward list.

2. Poll System

The primary port of primary node sends Hello packet to its neighbors timely according to configured Hello-timer.

If the ring is health, the secondary port of primary node receives health detect packet, and the primary node keeps secondary port.

If the ring is break, the secondary port of primary node can't receive health detect packet when timer is over time. The primary releases the secondary port block state, and sends LINK-DOWN-FLUSH_FDB packet to inform all of transfer nodes, to refresh own MAC address forward list.

3. Ring Restore

After the primary node occur ring fail, if the secondary port receives Hello packet sending from primary node, the ring has been restored, at the same time the primary node block its secondary port, and sends its neighbor LINK-UP-Flush-FDB packet.

After MRPP ring port refresh UP on transfer node, the primary node maybe find ring restore after a while. For the normal data VLAN, the network maybe forms a temporary ring and creates broadcast storm. To avoid temporary ring, transfer node finds it to connect to ring network port to refresh UP, immediately block temporarily (only permit control VLAN packet pass), after only receiving LINK-UP-FLUSH-FDB packet from primary node, and releases the port block state.

8.3.2 MRPP Configuration Task List

- 1) Globally enable MRPP
- 2) Configure MRPP ring
- 3) Configure the query time of MRPP
- 4) Configure the compatible mode
- 5) Display and debug MRPP relevant information

1) Globally enable MRPP

Command	Explanation
Global Mode	
mrpp enable no mrpp enable	Globally enable and disable MRPP.

2) Configure MRPP ring

Command	Explanation
Global Mode	
mrpp ring <ring-id> no mrpp ring <ring-id>	Create MRPP ring. The “no” command deletes MRPP ring and its configuration.

MRPP ring mode	
control-vlan <vid> no control-vlan	Configure control VLAN ID, format “no” deletes configured control VLAN ID.
node-mode {master transit}	Configure node type of MRPP ring (primary node or secondary node).
hello-timer <timer> no hello-timer	Configure Hello packet timer sending from primary node of MRPP ring, format “no” restores default timer value.
fail-timer <timer> no fail-timer	Configure Hello packet overtime timer sending from primary node of MRPP ring, format “no” restores default timer value.
enable no enable	Enable MRPP ring, format “no” disables enabled MRPP ring.
Port mode	
mrpp ring <ring-id> primary-port no mrpp ring <ring-id> primary-port	Specify primary port of MRPP ring.
mrpp ring <ring-id> secondary-port no mrpp ring <ring-id> secondary-port	Specify secondary port of MRPP ring.

3) Configure the query time of MRPP

Command	Explanation
Global Mode	
mrpp poll-time <20-2000>	Configure the query interval of MRPP.

4) Configure the compatible mode

Command	Explanation
Global Mode	
mrpp errp compatible no mrpp errp compatible	Enable the compatible mode for ERRP, the no command disables the compatible mode.
mrpp eaps compatible no mrpp eaps compatible	Enable the compatible mode for EAPS, the no command disables the compatible mode.
errp domain <domain-id> no errp domain <domain-id>	Create ERRP domain, the no command deletes the configured ERRP domain.

5) Display and debug MRPP relevant information

Command	Explanation
Admin Mode	
debug mrpp no debug mrpp	Disable MRPP module debug information, format “no” disable MRPP debug information output.
show mrpp {<ring-id>}	Display MRPP ring configuration information.
show mrpp statistics {<ring-id>}	Display receiving data packet statistic information of MRPP ring.
clear mrpp statistics {<ring-id>}	Clear receiving data packet statistic

information of MRPP ring.

8.3.3 MRPP Typical Scenario

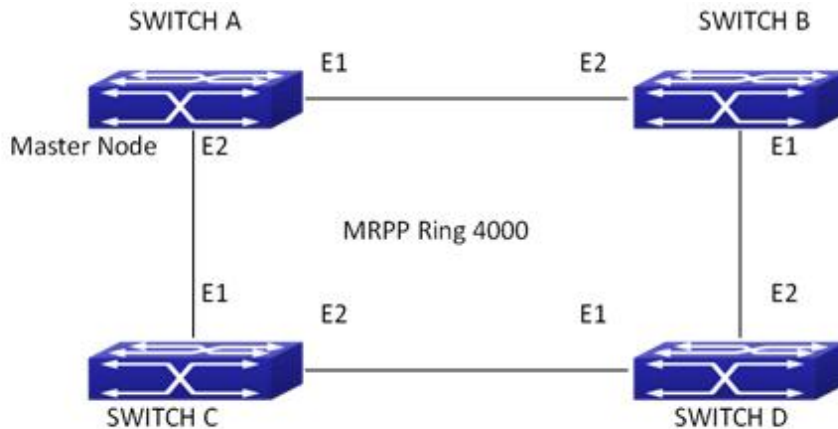

Figure 7-8 MRPP typical configuration scenario

The above topology often occurs on using MRPP protocol. The multi switch constitutes a single MRPP ring, all of the switches only are configured an MRPP ring 4000, thereby constitutes a single MRPP ring.

In above configuration, SWITCH A configuration is primary node of MRPP ring 4000, and configures E1/0/1 to primary port, E1/0/2 to secondary port. Other switches are secondary nodes of MRPP ring, configures primary port and secondary port separately.

To avoid ring, it should temporarily disable one of the ports of primary node, when it enables each MRPP ring in the whole MRPP ring; and after all of the nodes are configured, open the port.

When disable MRPP ring, it needs to insure the MRPP ring doesn't have ring.

SWITCH A configuration Task Sequence:

```
Switch(Config)#mrpp enable
Switch(Config)#mrpp ring 4000
Switch(mrpp-ring-4000)#control-vlan 4000
Switch(mrpp-ring-4000)#fail-timer 18
Switch(mrpp-ring-4000)#hello-timer 5
Switch(mrpp-ring-4000)#node-mode master
Switch(mrpp-ring-4000)#enable
Switch(mrpp-ring-4000)#exit
Switch(Config)#interface ethernet 1/0/1
Switch(config-If-Ethernet1/0/1)#mrpp ring 4000 primary-port
Switch(config-If-Ethernet1/0/1)#interface ethernet 1/0/2
Switch(config-If-Ethernet1/0/2)#mrpp ring 4000 secondary-port
Switch(config-If-Ethernet1/0/2)#exit
Switch(Config)#
```

SWITCH B configuration Task Sequence:

```
Switch(Config)#mrpp enable
```



```
Switch(Config)#mrpp ring 4000
Switch(mrpp-ring-4000)#control-vlan 4000
Switch(mrpp-ring-4000)#enable
Switch(mrpp-ring-4000)#exit
Switch(Config)#interface ethernet 1/0/1
Switch(config-If-Ethernet1/0/1)#mrpp ring 4000 primary-port
Switch(config-If-Ethernet1/0/1)#interface ethernet 1/0/2
Switch(config-If-Ethernet1/0/2)#mrpp ring 4000 secondary-port
Switch(config-If-Ethernet1/0/2)#exit
Switch(Config)#
```

SWITCH C configuration Task Sequence:

```
Switch(Config)#mrpp enable
Switch(Config)#mrpp ring 4000
Switch(mrpp-ring-4000)#control-vlan 4000
Switch(mrpp-ring-4000)#enable
Switch(mrpp-ring-4000)#exit
Switch(Config)#interface ethernet 1/0/1
Switch(config-If-Ethernet1/0/1)#mrpp ring 4000 primary-port
Switch(config-If-Ethernet1/0/1)#interface ethernet 1/0/2
Switch(config-If-Ethernet1/0/2)#mrpp ring 4000 secondary-port
Switch(config-If-Ethernet1/0/2)#exit
Switch(Config)#
```

SWITCH D configuration Task Sequence:

```
Switch(Config)#mrpp enable
Switch(Config)#mrpp ring 4000
Switch(mrpp-ring-4000)#control-vlan 4000
Switch(mrpp-ring-4000)#enable
Switch(mrpp-ring-4000)#exit
Switch(Config)#interface ethernet 1/0/1
Switch(config-If-Ethernet1/0/1)#mrpp ring 4000 primary-port
Switch(config-If-Ethernet1/0/1)#interface ethernet 1/0/2
Switch(config-If-Ethernet1/0/2)#mrpp ring 4000 secondary-port
Switch(config-If-Ethernet1/0/2)#exit
Switch(Config)#
```

8.3.4 MRPP Troubleshooting

The normal operation of MRPP protocol depends on normal configuration of each switch on MRPP ring, otherwise it is very possible to form ring and broadcast storm:

- ☞ Configuring MRPP ring, you'd better disconnected the ring, and wait for each switch configuration, then open the ring.
- ☞ When the MRPP ring of enabled switch is disabled on MRPP ring, it ensures the ring of the

MRPP ring has been disconnected.

- ☞ When there is broadcast storm on MRPP ring, it disconnects the ring firstly, and ensures if each switch MRPP ring configuration on the ring is correct or not; if correct, restores the ring, and then observes the ring is normal or not.
- ☞ The convergence time of MRPP ring net is relative to the response mode of up/down. If use poll mode, the convergence time as hundreds of milliseconds in simple ring net, if use interrupt mode, the convergence time within 50 milliseconds.
- ☞ Generally, the port is configured as poll mode, interrupt mode is only applied to better performance environment, but the security of poll mode is better than interrupt mode, port-scan-mode {interrupt | poll} command can be consulted.
- ☞ In normal configuration, it still forms ring broadcast storm or ring block, please open debug function of primary node MRPP, and used show MRPP statistics command to observe states of primary node and transfer node and statistics information is normal or not, and then sends results to our Technology Service Center.

8.4 ULPP

8.4.1 Introduction to ULPP

Each ULPP group has two uplink ports, they are master port and slave port. The port may be a physical port or a port channel. The member ports of ULPP group have three states: Forwarding, Standby, Down. Normally, only one port at the forwarding state, the other port is blocked at the Standby state. When the master port has the link problem, the master port becomes down state, and the slave port is switthed to forwarding state.

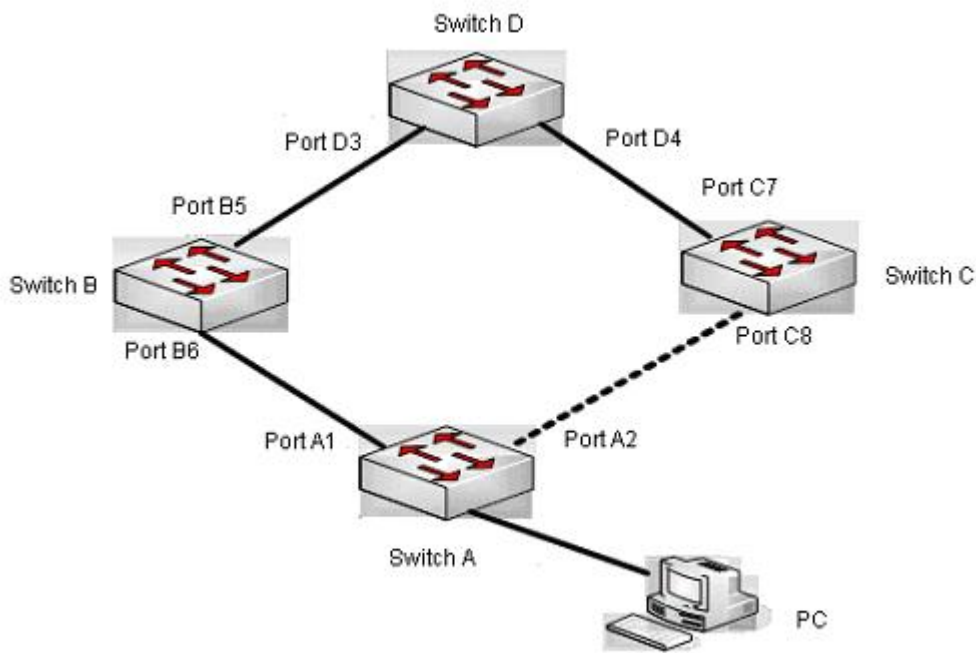

Figure 7-9 the using scene of ULPP

The above figure uses the double-uplink network, this is the typical application scene of ULPP. SwitchA goes up to SwitchD through SwitchB and SwitchC, port A1 and port A2 are the uplink ports. SwitchA configures ULPP, thereinto port A1 is set as the master port, port A2 is set as the slave port. When port A1 at forwarding state has the problem, switch the uplink at once, port A2 turns into forwarding state. After this, when recovering the master port, if the preemption mode is not configured, port A2 keeps the Forwarding state, port A1 turns into the Standby state.

After the preemption mode is enabled, so as to the master port preempts the slave port when it recovered from the problem. For avoiding the frequent uplink switch caused by the abnormality problem, the preemption delay mechanism is imported, and it needs to wait for some times before the master port preempt the slave port. For keeping the continuance of the flows, the master port does not process to preempt by default, but turns into the Standby state.

When configuring ULPP, it needs to specify the VLAN which is protected by this ULPP group through the method of MSTP instances, and ULPP does not provide the protection to other VLANs.

When the uplink switch is happennig, the primary forwarding entries of the device will not be applied to new topology in the network. In the figure, SwitchA configures ULPP, the portA1 as the master port at forwarding state, here the MAC address of PC is learned by Switch D from portD3. After this, portA1 has the problem, the traffic is switched to portA2 to be forwarded. If there is the data sent to PC by SwitchD, still the data will be forwarded from portD3, and will be losed. Therefore, when switching the uplink, the device of configuring ULPP needs to send the flush packets through the port which is switched to Forwarding state, and update MAC address tables and ARP tables of other devices in the network. ULPP respectively uses two kinds of flush packets to update the entries: the updated packets of MAC address and the deleted packets of ARP.

For making use of the bandwidth resource enough, ULPP can implement VLAN load balance through the configuration. As the picture illustrated, SwitchA configures two ULPP groups:

portA1 is the master port and portA2 is the slave port in group1, portA2 is the master port and portA1 is the slave port in group2, the VLANs are protected by group1 and group2, they are 1-100 and 101-200. Here both portA1 and portA2 at the forwarding state, the master port and the slave port mutually backup, and respectively forward the packets of the different VLAN ranges. When portA1 has the problem, the traffic of VLAN 1-200 are forwarded by portA2. After this, when portA1 is recovering the normal state, portA2 forwards the data of VLAN 101-200 sequentially, but the data of VLAN 1-100 is switched to portA1 to forward.

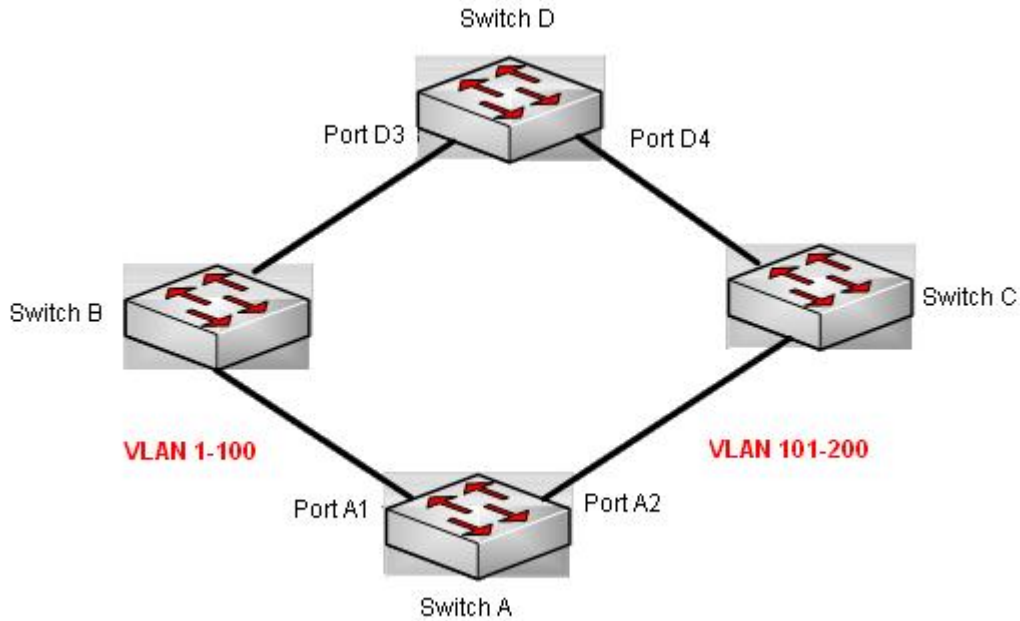

Figure 7- 10 VLAN load balance

8.4.2 ULPP Configuration Task List

1. Create ULPP group globally
2. Configure ULPP group
3. Show and debug the relating information of ULPP

1. Create ULPP group globally

Command	Expalnation
Global mode	
ulpp group <integer> no ulpp group <integer>	Configure and delete ULPP group globally.

2. Configure ULPP group

Command	Explanation
ULPP group configuration mode	
preemption mode	Configure the preemption mode of

no preempt mode	ULPP group. The no operation deletes the preempt mode.
preempt delay <integer> no preempt delay	Configure the preempt delay, the no operation restores the default value 30s.
control vlan <integer> no control vlan	Configure the sending control VLAN, no operation restores the default value 1.
protect vlan-reference-instance <instance-list> no protect vlan-reference-instance <instance-list>	Configure the protection VLANs, the no operation deletes the protection VLANs.
flush enable mac flush disable mac	Enable or disable sending the flush packets which update MAC address.
flush enable arp flush disable arp	Enable or disable sending the flush packets which delete ARP.
flush enable mac-vlan flush disable mac-vlan	Enable or disable sending the flush packets of deleting the dynamic unicast mac according to vlan.
description <string> no description	Configure or delete ULPP group description.
Port mode	
ulpp control vlan <vlan-list> no ulpp control vlan <vlan-list>	Configure the receiving control VLANs, no operation restores the default value 1.
ulpp flush enable mac ulpp flush disable mac	Enable or disable receiving the flush packets which update the MAC address.
ulpp flush enable arp ulpp flush disable arp	Enable or disable receiving the flush packets which delete ARP.
ulpp flush enable mac-vlan ulpp flush disable mac-vlan	Enable or disable receiving the flush packets of mac-vlan type.
ulpp group <integer> master no ulpp group <integer> master	Configure or delete the master port of ULPP group.
ulpp group <integer> slave no ulpp group <integer> slave	Configure or delete the slave port of ULPP group.

3. Show and debug the relating information of ULPP

Command	Explanation
Admin mode	
show ulpp group [group-id]	Show the configuration information of the configured ULPP group.
show ulpp flush counter interface {ethernet <IFNAME> <IFNAME>}	Show the statistic information of the flush packets.

show ulpp flush-receive-port	Show flush type and control VLAN received by the port.
clear ulpp flush counter interface <name>	Clear the statistic information of the flush packets.
debug ulpp flush {send receive} interface <name> no debug ulpp flush {send receive} interface <name>	Show the information of the receiving and sending flush packets, the no operation disables the shown information.
debug ulpp flush content interface <name> no debug ulpp flush content interface <name>	Show the contents of the received flush packets, the no operation disables the showing.
debug ulpp error no debug ulpp error	Show the error information of ULPP, the no operation disables the showing.
debug ulpp event no debug ulpp event	Show the event information of ULPP, the no operation disables the showing.

8.4.3 ULPP Typical Examples

8.4.3.1 ULPP Typical Example1

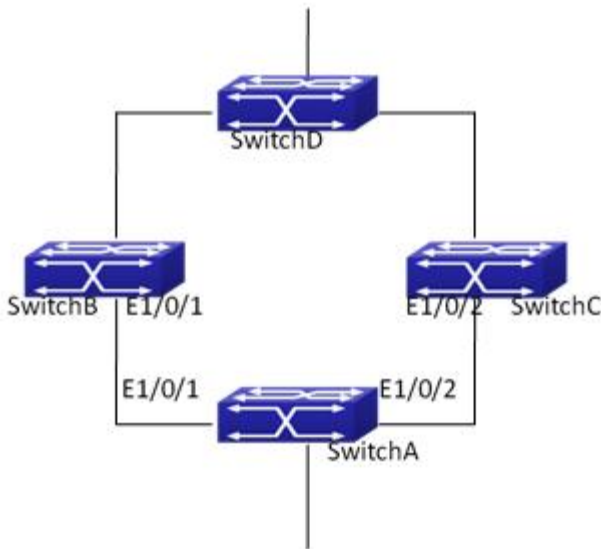

Figure 7-11 ULPP typical example1

The above topology is the typical application environment of ULPP protocol.

SwitchA has two uplinks, they are SwitchB and SwitchC. When any protocols are not enabled, this topology forms a ring. For avoiding the loopback, SwitchA can configure ULPP protocol, the master port and the slave port of ULPP group. When both master port and slave port are up, the slave port will be set as standby state and will not forward the data packets. When the master port is down, the slave port will be set as forwarding state and switch to the uplink. SwitchB and SwitchC can enable the command that receives the flush packets, it is used to

associate with ULPP protocol running of SwitchA to switch the uplink immediately and reduce the switch delay.

When configuring ULPP protocol of SwitchA, first, create a ULPP group and configure the protection VLAN of this group as vlan10, then configure interface Ethernet 1/0/1 as the master port, interface Ethernet 1/0/2 as the slave port, the control VLAN as 10. SwitchB and SwitchC configure the flush packets that receive ULPP.

SwitchA configuration task list:

```
Switch(Config)#vlan 10
Switch(Config-vlan10)#switchport interface ethernet 1/0/1; 1/0/2
Switch(Config-vlan10)#exit
Switch(Config)#spanning-tree mst configuration
Switch(Config-Mstp-Region)#instance 1 vlan 10
Switch(Config-Mstp-Region)#exit
Switch(Config)#ulpp group 1
Switch(ulpp-group-1)#protect vlan-reference-instance 1
Switch(ulpp-group-1)#control vlan 10
Switch(ulpp-group-1)#exit
Switch(Config)#interface ethernet 1/0/1
Switch(config-If-Ethernet1/0/1)# ulpp group 1 master
Switch(config-If-Ethernet1/0/1)#exit
Switch(Config)#interface Ethernet 1/0/2
Switch(config-If-Ethernet1/0/2)# ulpp group 1 slave
Switch(config-If-Ethernet1/0/2)#exit
```

SwitchB configuration task list:

```
Switch(Config)#vlan 10
Switch(Config-vlan10)#switchport interface ethernet 1/0/1
Switch(Config-vlan10)#exit
Switch(Config)#interface ethernet 1/0/1
Switch(config-If-Ethernet1/0/1)# ulpp flush enable mac
Switch(config-If-Ethernet1/0/1)# ulpp flush enable arp
Switch(config-If-Ethernet1/0/1)# ulpp control vlan 10
```

SwitchC configuration task list:

```
Switch(Config)#vlan 10
Switch(Config-vlan10)#switchport interface ethernet 1/0/2
Switch(Config-vlan10)#exit
Switch(Config)#interface ethernet 1/0/2
Switch(config-If-Ethernet1/0/2)# ulpp flush enable mac
Switch(config-If-Ethernet1/0/2)# ulpp flush enable arp
Switch(config-If-Ethernet1/0/2)# ulpp control vlan 10
```

8.4.3.2 ULPP Typical Example2

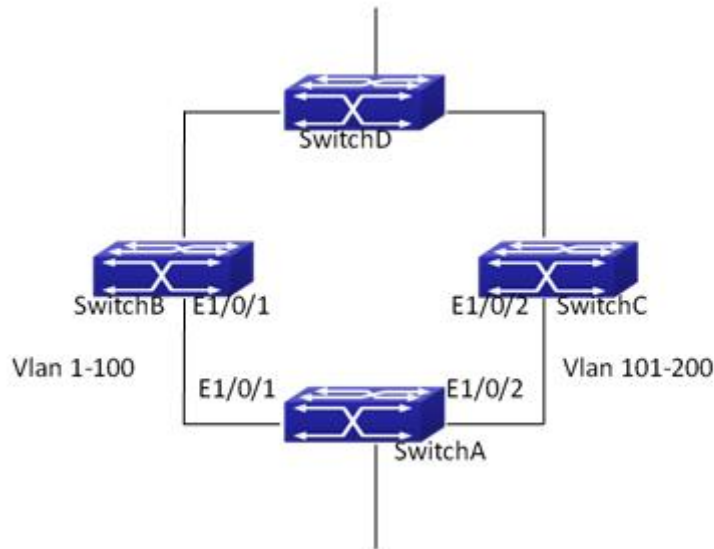

Figure 7-12 ULPP typical example2

ULPP can implement the VLAN-based load balance. As the picture illustrated, SwitchA configures two ULPP groups: port E1/0/1 is the master port and port 1/0/2 is the slave port in group1, port 1/0/2 is the master port and port 1/0/1 is the slave port in group2. The VLANs protected by group1 are 1-100 and by group2 are 101-200. Here both port E1/0/1 and port E1/0/2 at the forwarding state, the master port and the slave port mutually backup, respectively forward the packets of different VLAN ranges. When port E1/0/1 has the problem, the traffic of VLAN 1-200 are forwarded by port E1/0/2. When port E1/0/1 is recovering the normal state, still port E1/0/2 forwards the data of VLAN 101-200, the data of VLAN 1-100 are switched to port E1/0/1 to forward.

SwitchA configuration task list:

```
Switch(Config)#spanning-tree mst configuration
Switch(Config-Mstp-Region)#instance 1 vlan 1-100
Switch(Config-Mstp-Region)#instance 2 vlan 101-200
Switch(Config-Mstp-Region)#exit
Switch(Config)#ulpp group 1
Switch(ulpp-group-1)#protect vlan-reference-instance 1
Switch(ulpp-group-1)#preemption mode
Switch(ulpp-group-1)#exit
Switch(Config)#ulpp group 2
Switch(ulpp-group-2)#protect vlan-reference-instance 2
Switch(ulpp-group-2)#preemption mode
Switch(ulpp-group-2)#exit
Switch(Config)#interface ethernet 1/0/1
Switch(config-If-Ethernet1/0/1)#switchport mode trunk
Switch(config-If-Ethernet1/0/1)#ulpp group 1 master
Switch(config-If-Ethernet1/0/1)#ulpp group 2 slave
Switch(config-If-Ethernet1/0/1)#exit
Switch(Config)#interface Ethernet 1/0/2
```



```
Switch(config-If-Ethernet1/0/2)#switchport mode trunk
Switch(config-If-Ethernet1/0/2)# ulpp group 1 slave
Switch(config-If-Ethernet1/0/2)# ulpp group 2 master
Switch(config-If-Ethernet1/0/2)#exit
```

SwitchB configuration task list:

```
Switch(Config)#interface ethernet 1/0/1
Switch(config-If-Ethernet1/0/1)#switchport mode trunk
Switch(config-If-Ethernet1/0/1)# ulpp flush enable mac
Switch(config-If-Ethernet1/0/1)# ulpp flush enable arp
```

SwitchC configuration task list:

```
Switch(Config)#interface ethernet 1/0/2
Switch(config-If-Ethernet1/0/2)# switchport mode trunk
Switch(config-If-Ethernet1/0/2)# ulpp flush enable mac
Switch(config-If-Ethernet1/0/2)# ulpp flush enable arp
```

8.4.4 ULPP Troubleshooting

- ☞ At present, configuration of more than 2 multi-uplinks is allowed, but it may cause loopback, so is not recommended.
- ☞ With the normal configuration, if the broadcast storm happen or the communication along the ring is broken, please enable the debug of ULPP, copy the debug information of 3 minutes and the configuration information, send them to our technical service center.

8.5 ULSM

8.5.1 Introduction to ULSM

ULSM (Uplink State Monitor) is used to process the port state synchronization. Each ULSM group is made up of the uplink port and the downlink port, both the uplink port and the downlink port may be multiple. The port may be a physical port or a port channel, but it can not be a member port of a port channel, and each port only belongs to one ULSM group.

The uplink port is the monitored port of ULSM group. When all uplink ports are down or there is no uplink port in ULSM group, ULSM group state is down. ULSM group state is up as long as one uplink port is up.

The downlink port is the controlled port, its state changes along with Up/Down of ULSM group and is always the same with ULSM group state.

ULSM associates with ULPP to enable the downstream device to apperceive the link problem

of the upstream device and process correctly. As the picture illustrated, SwitchA configures ULPP, here the traffic is forwarded by port A1. If the link between SwitchB and Switch D has the problem, SwitchA can not apperceive the problem of the upstream link and sequentially forward the traffic from port A1, cause traffic losing.

Configuring ULSM on SwitchB can solve the above problems. The steps are: set port B5 as the uplink port of ULSM group, port B6 as the downlink port. When the link between SwitchB and SwitchD has the problem, both the downlink port B6 and the state of ULSM group are down. It causes Switch A on which ULPP is configured to process uplink switchover and avoid the data dropped.

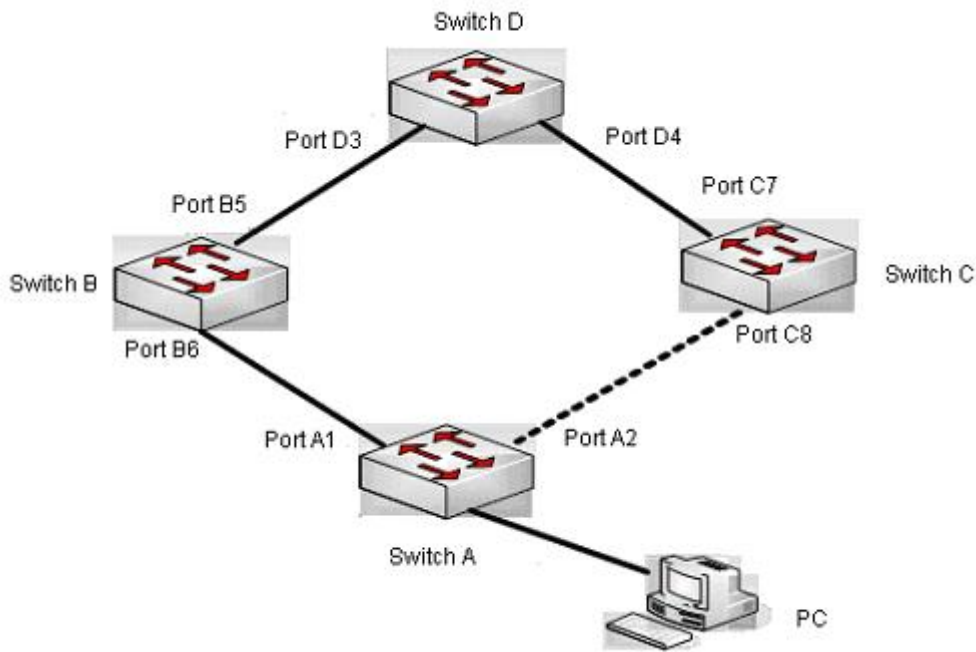

Fig 5- 1 ULSM using scene

8.5.2 ULSM Configuration Task List

1. Create ULSM group globally
2. Configure ULSM group
3. Show and debug the relating information of ULSM

1. Create ULSM group globally

Command	explanation
Global mode	
ulsm group <group-id> no ulsm group <group-id>	Configure and delete ULSM group globally.

2. Configure ULSM group

Command	explanation

Port mode	
ulsm group <group-id> {uplink downlink} no ulsm group <group-id> {uplink downlink}	Configure the uplink/downlink port of ULSM group, the no command deletes the uplink/downlink port.

3. Show and debug the relating information of ULSM

Command	Explanation
Admin mode	
show ulsm group [group-id]	Show the configuration information of ULSM group.
debug ulsm event no debug ulsm event	Show the event information of ULSM, the no operation disables the shown information.

8.5.3 ULSM Typical Example

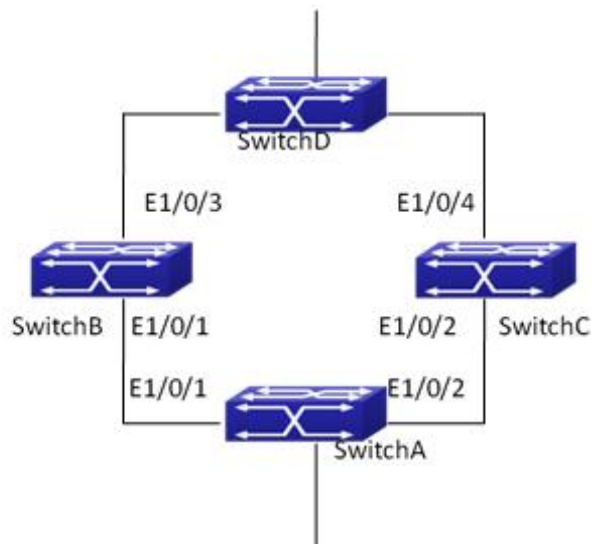

Fig 5-2 ULSM typical example

The above topology is the typical application environment which is used by ULSM and ULPP protocol.

ULSM is used to process the port state synchronization, its independent running is useless, so it usually associates with ULPP protocol to use. In the topology, SwitchA enables ULPP protocol, it is used to switch the uplink. SwitchB and SwitchC enable ULSM protocol to monitor whether the uplink is down. If it is down, then ULSM will execute the down operation for the downlink port to shutdown it, so ULPP protocol of Switch A executes the relative operation of the uplink switchover.

SwitchA configuration task list:

```
Switch(Config)#spanning-tree mst configuration
```

```
Switch(Config-Mstp-Region)#instance 1 vlan 1
```

```
Switch(Config-Mstp-Region)#exit
```

```
Switch(Config)#ulpp group 1
Switch(ulpp-group-1)#protect vlan-reference-instance 1
Switch(ulpp-group-1)#exit
Switch(Config)#interface ethernet 1/0/1
Switch(config-If-Ethernet1/0/1)# ulpp group 1 master
Switch(config-If-Ethernet1/0/1)#exit
Switch(Config)#interface Ethernet 1/0/2
Switch(config-If-Ethernet1/0/2)# ulpp group 1 slave
Switch(config-If-Ethernet1/0/2)#exit
```

SwitchB configuration task list:

```
Switch(Config)#ulsm group 1
Switch(Config)#interface ethernet 1/0/1
Switch(config-If-Ethernet1/0/1)#ulsm group 1 downlink
Switch(config-If-Ethernet1/0/1)#exit
Switch(Config)#interface ethernet 1/0/3
Switch(config-If-Ethernet1/0/3)#ulsm group 1 uplink
Switch(config-If-Ethernet1/0/3)#exit
```

SwitchC configuration task list:

```
Switch(Config)#ulsm group 1
Switch(Config)#interface ethernet 1/0/2
Switch(config-If-Ethernet1/0/2)#ulsm group 1 downlink
Switch(config-If-Ethernet1/0/2)#exit
Switch(Config)#interface ethernet 1/0/4
Switch(config-If-Ethernet1/0/4)#ulsm group 1 uplink
Switch(config-If-Ethernet1/0/4)#exit
```

8.5.4 ULSM Troubleshooting

- With the normal configuration, if the downlink port does not respond to the down event of the uplink port, please enable the debug function of ULSM, copy the debug information of 3 minutes and the configuration information, and send them to our technical service center.

8.6 ERPS

8.6.1 Introduction to ERPS

ERPS (Ethernet Ring Protection Switching) is a kind of layer2 anti-ring protocol which is defined by ITU-T; the standard number is ITU-T G.8032/Y1344, also known as G.8032. G.8032 Ethernet standard absorbs the advantages of the ring network protection technology of EAPS,

RPR, SDH, STP.etc. It optimizes the detection mechanism and it can detect the two-way/single-way fault, support the structure with multi-ring and multi-domain. At the same time of achieving rotating of 50ms, it supports the master and slave and load sharing. It becomes the newest standard of the Ethernet ring technology.

ERPS is the anti-ring protocol used in ring network protection. It includes: link switching in loop fault, notification and loop rotating after loop restored, but it does not include the discovery of link fault. The CCM function defined by 802.1ag protocol can be used in fault discovery and the physical link fault detection can also be used. The principle is that it must be flexible no matter which detection mechanism was used, the link fault can be found in a short time and it will be noticed to the erps module. The link fault rotating time that erps asks is: flow discontinuity time is 50ms at most with that the link length is in 1200km and in 16 nodes. It is demanding for the link fault discovery and loop protection protocol rotating time.

8.6.1.1 ERPS Terminology

Ethernet ring: It is the closed physical ring network which is made up by many ring nodes, every node on the ring has only two ports connecting to this ring network.

Ring protection link: RPL is a link on the ring network. When the ring network is healthy, the link blocked by the node cannot transmit the data flow.

RPL owner node: When the ring network is healthy, the nodes connected to RPL will block the RPL. At the same time, it will launch the link rotating when the ring network restored and it is configured as reversion.

RPL neighbor node: RPL neighbor node, it is the other node connected to RPL. When the ring network is healthy, it will block the RPL.

Interconnection node: Cross node, when there are many rings are crossed, it is the node in the cross position. On the cross nodes, there is one or more rings can be connected through two ports. The ring connected through one port is the sub-ring, the ring connected through two ports is the main ring.

R-APS virtual channel : It is the link which makes the sub-ring connect between two interconnection nodes out of the sub-ring path. Its transmission characteristic is related to the out ring network.

major-ring: It is the ring which connects the two ports on the interconnection node.

sub-ring: It is the ring which connects to other network through two interconnection nodes. it is not a ring network, it will make up a ring network only when connect it through the interconnection node.

ERP instance: It is a set protected by many vlan. The packet transmission of the vlan in this instance pass the same ring network link, every vlan only belongs to one instance.

Revertive switch: After learning of the ring network fault restored, the RPL owner node will restore the blockade status of RPL and make the network flow transmission path restore to the link before the fault.

Non-revertive switch: After learning of the ring network fault restored, the RPL owner node will not block the RPL, the network flow transmission path is same as before.

8.6.1.2 ERPS Function

8.6.1.2.1 Fault Switchover

The following is the single-ring and single link fault.

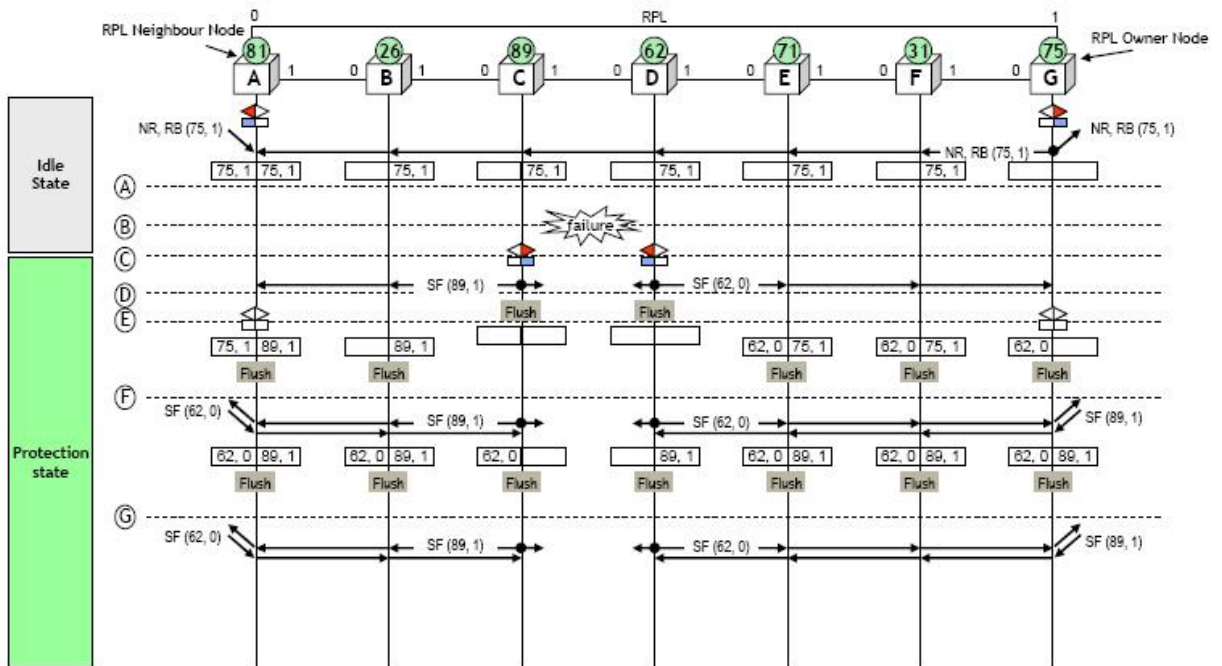

Figure 7- 13 single-link fault

The steps of fault switchover:

- The ring network status is normal; RPL owner node of G sends the R-APS (NR, RB) packet periodically. This packet explains that RPL link is in blockade status and the ring network is healthy.
- There is fault on the link between node C and D.
- The node C and D detected the fault, they block the port which connected to the fault link respectively and run the flush FDB.
- At the same time, the node C and D send the fault notification packet of R-APS (SF) respectively through the port connected to the ring network.
- All the nodes which received R-APS (SF) packet will run the flush FDB. At the same time, RPL owner node of G and RPL neighbor node of A will configure the RPL connection port as forward. The node G will stop sending R-APS (NR, RB) packet.
- Because RPL link has removed the blockade, all nodes can receive two R-APS (SF) packets (sent by node C and D). after receiving the new R-APS (SF) packet, it will run the flush FDB.
- Link fault message of R-APS (SF) will transmitting always in the ring network.

8.6.1.2.2 Failure Recovery

When the ring link restored, there are two methods on the ring nodes: one is

Revertive switch. After the ring link restored to be normal, the ring network will block the RPL, and restore the forwarding status of the fault link. At this time, the forwarding path of the data packet is same as the last once when it is normal. Another one is Non-revertive switch. After the ring link restored to be normal, the link will keep the block status. The data packet will continue to be forwarded with the current path.

The environments of the two methods are different. When the block RPL can make the data flow transmission path be the best, use the Revertive switch; when the path costs are similar, there is no difference no matter which path will be blocked, for preventing the secondary interruption of data flow, use the Non-revertive switch.

1. Revertive switch

The following is the single-ring and single link fault.

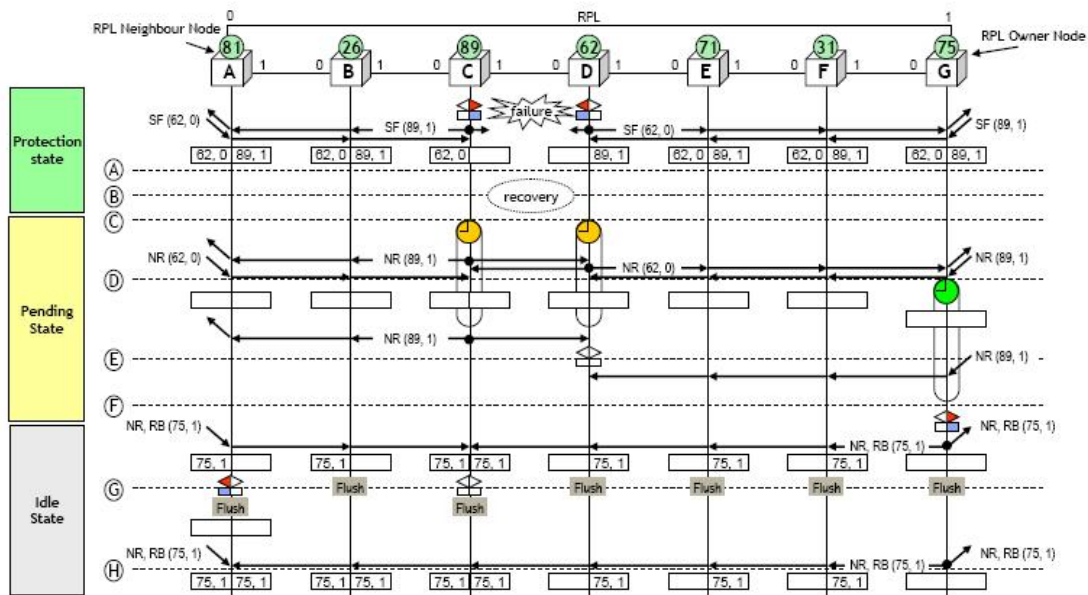

Figure 7-14 Revertive switch fault restoration of single link

The steps:

- The fault still existed, the node which has detected the fault will send the R-APS (SF) packets with the fault message periodically;
- Fault restoration on the link;
- The nodes of C and D detects the fault restoration, they will start the guard timer and send the fault restoration packets of R-APS (NR) on the ports of the ring network at the same time;
- When the RPL owner node detected R-APS (NR) packets, it will start the WTR timer and clear the local node fault message at the same time;
- After the nodes C and D are time out, they receives the R-APS (NR) packets from the peer. The node D thinks the priority of node C is higher, so it will stop sending the R-APS (NR) packets with the local message and relieve the block of the port;

- f) When the WTR timer of RPL owner node G is time out, it will block the port connected to RPL and send the R-APS (NR, RB) packets through the ring network port to notify other nodes that RPL link has been blocked. At the same time, the node G run the flush FDB;
- g) When the node C received the R-APS (NR, RB) packets sent by RPL owner node, it will relieve the block of the local port and stop sending NR packets at the same time. After RPL neighbor node A received this packet, it will block the port connected to RPL. Other, all nodes will run the flush FDB after received R-APS (NR, RB) packets.

2. Non-revertive switch

The following example is about the single-ring and single link fault as shown in Fig 7-15.

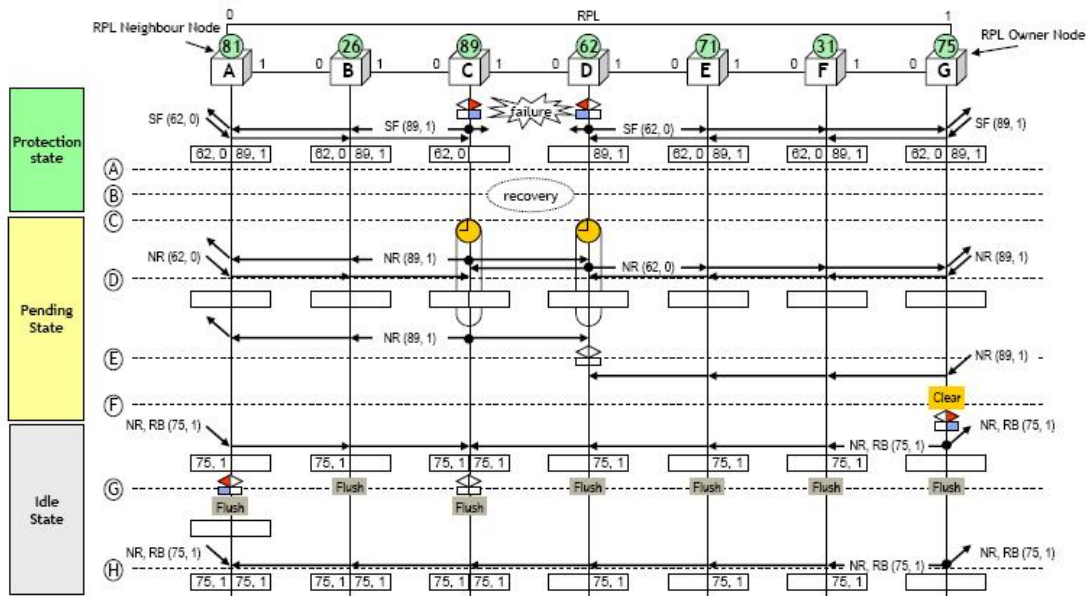

Figure 7-15 Non-revertive switch fault restoration of single link

The steps:

- a) The fault still existed, the node which has detected the fault will send the R-APS (SF) packets with the fault message periodically;
- b) Fault restoration on the link;
- c) The nodes of C and D detects the fault restoration, they will start the guard timer and send the fault restoration packets of R-APS (NR) on the ports of the ring network at the same time;
- d) When the RPL owner node G detected the R-APS (NR) packets, it will clear the local node fault message because of the configured non-revertive method, but it will not start the WTR timer;
- e) After the nodes C and D are time out, they receives the R-APS (NR) packets from the peer. The node D thinks the priority of node C is higher, so it will stop sending the R-APS (NR) packets and relieve the block of the local port;
- f) If RPL owner node G runs clear command, it will be recovered to be revertive method and it will block the port connected to RPL and send R-APS (NR, RB) packets through the ring network port to notify other nodes that the RPL link has been blocked. At the same time, it will run flush FDB;

- g) When the node C received the packets sent by RPL owner node, it will relieve the block of the local port and stop sending R-APS (NR) packets at the same time. After RPL neighbor node A received this packet, it will block the port connected to RPL. Other, all nodes will run the flush FDB after received the packets.

8.6.1.2.3 Interconnection Ring Model

ERPS protocol can support the protection and switching of the interconnection ring. The interconnection ring includes two types: the interconnection ring model with virtual channel and the interconnection ring model without virtual channel.

1. The interconnection ring model with virtual channel

As shown in Fig 7-16, three ring networks are interconnection. Ring 1 is the major ring and it is made up with the ring nodes A, B, G, H and the links of them. When ring 1 is health, it will block the link between nodes A and B. ring 2 is another major ring, it is made up with the ring nodes C, D, E, F and the links of them. When ring 2 is health, it will block the link between node C and D. ring 3 is a sub ring, it is made up with the nodes B, C, F, G and the links of B-C and G-F. When ring 3 is health, it will block the link of B-C. B-G links are the interconnection links of ring 1 and ring 3 and it belongs to ring 1. C-F links are the interconnection links of ring 2 and ring 3 and it belongs to ring 2. Ring 1 and ring 2 are both the close ring network, ring 3 is not a ring network. If treat ring 1 as the link between the interconnection nodes B and G of ring 3 (virtual channel), and treat ring 2 as the link between the interconnection nodes C and F of ring 3 (virtual channel), ring 3 will be a ring network.

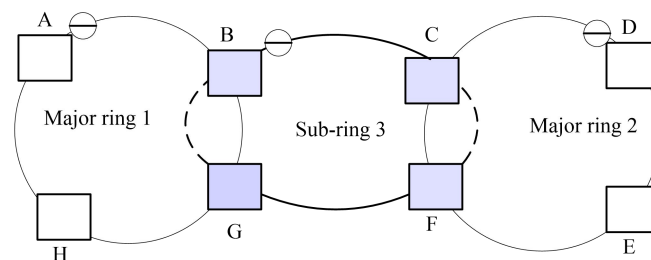

Figure 7- 16 the interconnection ring topology with virtual channel

The R-APS virtual channel supported by ring 1 and ring 2 treats ring 3 protocol packets as the data packets. The transmission method of the packets is same as the method of data packets. The node B of ring 3 sends and receives the ring 3 erps protocol packets sent by node G, at the same time, the node G sends and receives the ring 3 erps protocol packets sent by node B. For distinguishing the erps packets of ring 3 and the erps packets of this major ring in ring 1 and ring 2, different control vlan can be used to the protocol packets transmission of every ring.

When the sub ring 3 is changing, it should notify ring 1 and ring 2. The node on the major ring will run flush FDB. The topology changing of the major ring 1 and ring 2 will not affect the sub ring 3. Other, the topology changing of the major ring 1 and ring 2 will not affect each other either.

2. The interconnection ring model without virtual channel

Change the way to understand the ring network as shown in Fig 7-17: ring 1 is the major ring and it is made up with the ring nodes A, B, G, H and the links of them. When ring 1 is health, it will block the link between nodes A and B. ring 2 is sub ring, it is made up with the ring nodes C, D, E, F and the links of C-D, D-E and E-F. When ring 2 is health, it will block the link between node C and D. ring 3 is another sub ring, it is made up with the nodes B, C, F, G and the links of B-C, C-F and F-G. When ring 3 is health, it will block the link of B-C. B-G links are the interconnection links of ring 1 and ring 3 and it belongs to ring 1. C-F links are the interconnection links of ring 2 and ring 3 and it belongs to ring 3. Ring 1 is the close ring network; ring 2 and ring 3 are not the ring network.

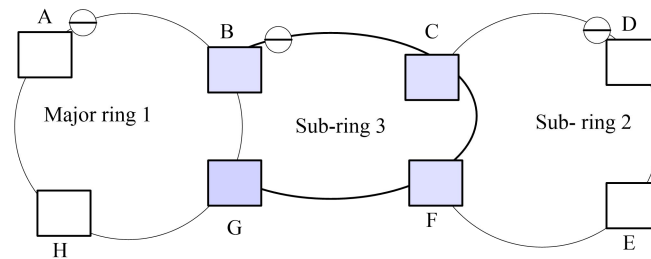

Figure 7- 17 the interconnection ring topology without virtual channel

Although ring 2 and ring 3 are not ring network neither, the erps packets of these two sub ring need to be transmitted to all ring nodes. So, the block link should still transmit erps protocol packets if the links of B-C and C-D are blocked, and the nodes B, C and C, D of the block link should also receive and send the erps protocol packets.

When the sub ring 3 is changing, it should notify ring 1. The node on the major ring will run flush FDB. The topology changing will not affect the sub ring 2. When the sub ring 2 is changing, it will affect the sub ring 3 and the major ring 1. The node on the major ring should run flush FDB. But, the topology changing of the major ring 1 will not affect the sub ring 2 and ring 3.

8.6.1.3 ERPS Application

ERPS is used for ring network and it is located in convergence layer, the convergence loop can complete the layer2 convergence of business; insert the layer3

network to deal with the business at the same time. The convergence loop runs ERPS protocol and provides layer2 redundancy protection exchange function of convergence loop.

8.6.2 ERPS Configuration

ERPS Configuration task list as below:

- 1) Create the instance; the map is corresponding to the vlan which should be protected
- 2) Create ERPS loop, and configure the member port information. The default configuration: support version V2, the main loop closing type and monitor the physical status of port
- 3) Configure ERPS loop instance and configure the protection instance, port roles. Configure the ERPS loop instance name, R-APS level, timer information. Configure the controlling VLAN at last and select the port to configure it as RPL owner and RPL Neighbor

1. Create the MSTP instance

Command	Explanation
Global Mode	
spanning-tree mst configuration no spanning-tree mst configuration	Enter into the MST configuration mode, configure the parameters of MSTP domain; the no command recovers to be the default.
MST Mode	
instance <instance value > vlan <vlan-list> no instance [instance-value]	Configure vlan which needs to be protected by the instance and mapping; the no command deletes the appointed instance.

2. Create ERPS ring and configure the member ports information

Command	Explanation
Global Mode	
erps ring <ring-name> no erps ring <ring-name>	Create ERPS ring and enter into the ERPS ring configuration mode; the no command deletes the appointed erps ring.
Port Mode	
erps-ring <ring-name> port0 erps-ring <ring-name> port1 erps-ring <ring-name> port0 erps-ring <ring-name> port1	Configure the port0 or port1 which is the ring node of port; the no command deletes their property.

3. Configure ERPS ring instance

Command	Explanation
Global Mode	
erps ring <ring-name> no erps ring <ring-name>	Create ERPS ring and enter into the ERPS ring configuration mode; the no command deletes the appointed erps ring.

ERPS Ring Configuration Mode	
eprs-instance <instance-id> no eprs-instance <instance-id>	Create ERPS ring instance and enter into the ERPS ring configuration mode; the no command deletes the appointed ring node instance.
description <instance-name> no description	Configure the description string of ERPS instance; the no command deletes the appointed string.
rpl {port0 port1} {owner neighbour} no rpl {port0 port1}	Configure the member port of ERPS ring instance as RPL owner or RPL neighbor; the no command deletes the appointed owner or neighbor node.
raps-mel <level-value> no raps-mel	Configure the level of R-APS channel, the MEL field in the protocol packets is used to detect if the current packet can pass by; the no command deletes the level of R-APS channel.
protected-instance <instance-list> no protected-instance	Configure the protection instance of ERPS ring instance. The no command deletes the protection instance.
wtr-timer <wtr-times> no wtr-timer	Configure the WTR timer. The WTR timer is used to avoid the configuration of frequent switching of RPL owner node because of the periodic (discontinuity) fault. The no command deletes the wtr timer.
guard-timer <guard-times> no guard-timer	Configure the Guard timer. The Guard timer is used in Ethernet ring node to avoid the wrong configuration according to the outdated R-APS packets and avoid the close loop. The no command deletes the guard timer.
holdoff-timer <holdoff-times> no holdoff-timer	Configure the Holdoff timer. The Holdoff timer is used for Ethernet ring node blocking fault report time. The no command deletes the Holdoff timer.
control-vlan <vlan-id> no control-vlan	Configure the control vlan of R-APS channel transmission R-APS packets. In the ERPS ring instance, this vlan is used to deliver the ERPS protocol packets but not to forward the user business packets. It improves the security of ERPS protocol. The no command deletes the Control Vlan.

4. Show the configuration information of ERPS

Command	Explanation
Global Mode	
show erps ring {<ring-name> brief}	Show ERPS ring information.
show erps instance [ring <ring-name> [instance <instance-id>]]	Show ERPS ring instance information.
show erps status [ring <ring-name> [instance <instance-id>]]	Show ERPS ring instance status information.
show erps statistics [ring <ring-name> [instance <instance-id>]]	Show ERPS ring instance statistic information.

8.6.3 ERPS Examples

Case 1:

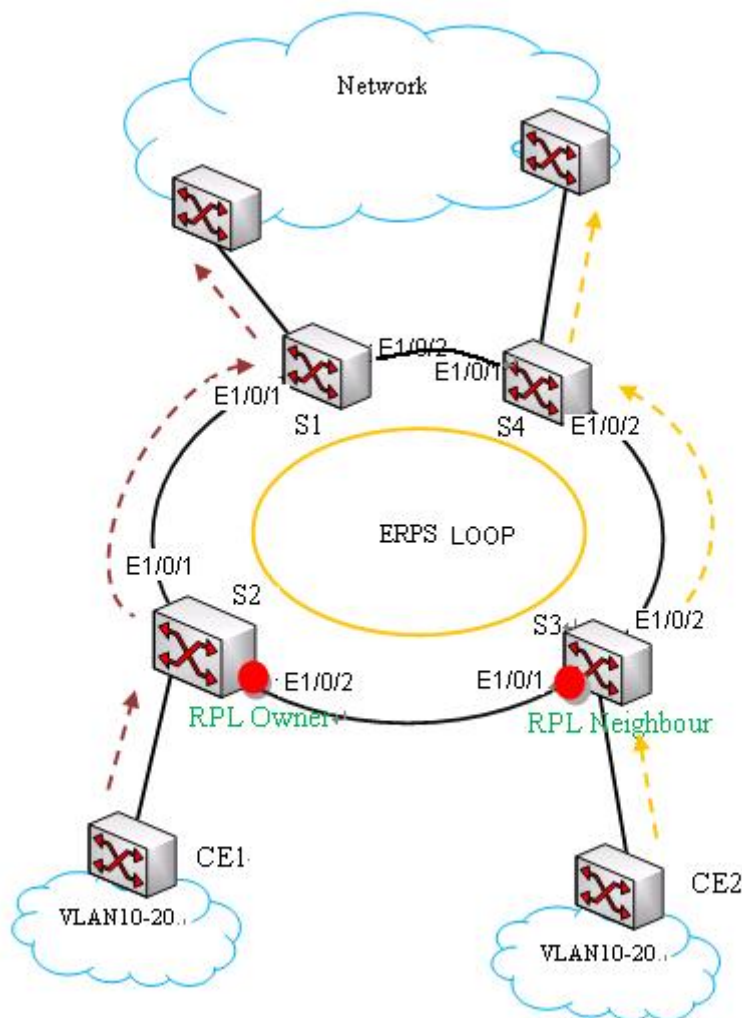

As shown in the picture above, it is the explanation of ERPS configuration and application. S1~S4 make up the ring network and provide the layer2 redundancy protection transform function. For preventing the packets in VLAN10 ~ VLAN20 come to be loop, deploy the ERPS protocol on

the devices which make up the ring network. The forwarding path of user data inserted through CE1 is S2-S1 and it is S3-S4 for the data which is deserted through CE2. For protecting the Ethernet loop switching, configure it as below:

1. Configuration thinking

Configure ERPS loop redundancy protection as below:

Create ERPS loop of majior_ring1 and configure the loop member port;

Configure the instance 1 on ERPS loop of majior_ring1 and configure the protection instance, member port role, timer and controlling VLAN.

2. Configuration steps

Step1: Create instance 2, VLAN2 and VLAN10-20 on S1 ~ S4, VLAN2 is used to transmit the protocol packets, VLAN10-20 are used to transmit the data packets.

Configuration of S1:

```
S1#config
```

```
S1(config)#spanning-tree mst configuration
```

```
S1(Config-Mstp-Region) instance 2 vlan 2;10-20
```

```
S1(Config-Mstp-Region)#exit
```

```
S1(config)#interface e1/0/1-2
```

```
S1(Config-If-Port-Range)#switchport mode trunk
```

The configuration of S2, S3 and S4 is same as S1.

Step2: Create ERPS loop and configure the member port information. The default configuration: support version V2, main loop closing type and monitor the physical status of port.

Configuration of S1:

```
S1(config)#erps-ring majior_ring1
```

```
S1(config-erps-ring)#exit
```

```
S1(config)# interface e1/0/1
```

```
S1(config-if-ethernet1/0/1)erps-ring majior_ring1 port 0
```

```
S1(config-if-ethernet1/0/1)interface e1/0/2
```

```
S1(config-if-ethernet1/0/2)erps-ring majior_ring1 port 1
```

Step3: Configure ERPS loop instance and configure the protection instance, port role. Configure the ERPS loop instance name, R-APS level, timer information. Configure the controlling VLAN at last and configure the port e1/0/2 of S2 as RPL owner and RPL Neighbor is for e1/0/1 of S3.

Configuration of S1:

```
S1(config)# erps-ring majior_ring1
```

```
S1(config-erps-ring)#erps-instance 1
```

```
S1(config-erps-ring-inst-1)#description instance1
```

```
S1(config-erps-ring-inst-1)#raps-mel 3
```

```
S1(config-erps-ring-inst-1)#protected-instance 2
```

```
S1(config-erps-ring-inst-1)#wtr-timer 8
```

```
S1(config-erps-ring-inst-1)#guard-timer 100
```

```
S1(config-erps-ring-inst-1)#holdoff-timer 5
```

```
S1(config-erps-ring-inst-1)# control-vlan 2
```

The configuration of S4 is same as S1.

Configuration of S2:

```
S2(config)# erps-ring maijor_ring1
S2(config-erps-ring)#erps-instance 1
S2(config-erps-ring-inst-1)#description instance1
S2(config-erps-ring-inst-1)#rpl port 1 owner
S2(config-erps-ring-inst-1)#non-revertive
S2(config-erps-ring-inst-1)#raps-mel 3
S2(config-erps-ring-inst-1)#protected-instance 2
S2(config-erps-ring-inst-1)#wtr-timer 8
S2(config-erps-ring-inst-1)#guard-timer 100
S2(config-erps-ring-inst-1)#holdoff-timer 5
S2(config-erps-ring-inst-1)# control-vlan 2
```

Configuration of S3:

```
S3(config)# erps-ring maijor_ring1
S3(config-erps-ring)#erps-instance 1
S3(config-erps-ring-inst-1)#description instance1
S3(config-erps-ring-inst-1)# rp0 port 1 neighbour
S3(config-erps-ring-inst-1)#raps-mel 3
S3(config-erps-ring-inst-1)#protected-instance 2
S3(config-erps-ring-inst-1)#wtr-timer 8
S3(config-erps-ring-inst-1)#guard-timer 100
S3(config-erps-ring-inst-1)#holdoff-timer 5
S3(config-erps-ring-inst-1)# control-vlan 2
```

Step 4: Check the configuration result. After the configuration above is successful, check the configuration result and below is for S2.

```
S2# show erps ring brief
```

Ring-ID	Description	Ring-topo	Port0	Port1	Version	Inst-Count
1	maijor_ring1	maijor-ring	1/0/1	1/0/2	V2	1

```
Switch#show erps instance
```

```
ERPS Ring maijor_ring1
```

```
Instance 1
```

```
Description: instance1
```

```
Protected Instance : 2
```

```
Revertive mode: revertive
```

```
RAPS MEL: 3
```

```
R-APS-Virtual-Channel:
```

```
Control Vlan : 2
```

```
Guard Timer (csec) : 100
```

```
Holdoff Timer (seconds) : 5
```

```
WTR Timer (min) : 8
```

Port	Role	Port-Status
port0	Common	Forwarding
port1	RPL Owner	Blocked

3. Configure the file

The configuration file of S1:

```
S1#config
S1(config)#erps-ring major_ring1
S1(config)#spanning-tree mst configuration
S1(Config-Mstp-Region) instance 2 vlan 2;10-20
S1(Config-Mstp-Region)#exit
S1(config)#interface e1/0/1-2
S1(Config-If-Port-Range)#switchport mode trunk
S1(Config-If-Port-Range)#exit
S1(config)# interface e1/0/1
S1(config-if-ethernet1/0/1)erps-ring major_ring1 port 0
S1(config-if-ethernet1/0/1)interface e1/0/2
S1(config-if-ethernet1/0/2)erps-ring major_ring1 port 1
S1(config-if-ethernet1/0/2)exit
S1(config)#erps-ring major_ring1
S1(config-erps-ring)#erps-instance 1
S1(config-erps-ring-inst-1)#description instance 1
S1(config-erps-ring-inst-1)#raps-mel 3
S1(config-erps-ring-inst-1)#protected-instance 2
S1(config-erps-ring-inst-1)#wtr-timer 8
S1(config-erps-ring-inst-1)#guard-timer 100
S1(config-erps-ring-inst-1)#holdoff-timer 5
S1(config-erps-ring-inst-1)# control-vlan 2
```

The configuration file of S2:

```
S2#config
S2(config)#erps-ring major_ring1
S2(config)#spanning-tree mst configuration
S2(Config-Mstp-Region) instance 2 vlan 2;10-20
S2(Config-Mstp-Region)#exit
S2(config)#interface e1/0/1-2
S2(Config-If-Port-Range)#switchport mode trunk
S2(Config-If-Port-Range)#exit
S2(config)# interface e1/0/1
S2(config-if-ethernet1/0/1)erps-ring major_ring1 port 0
S2(config-if-ethernet1/0/1)interface e1/0/2
S2(config-if-ethernet1/0/2)erps-ring major_ring1 port 1
S2(config-if-ethernet1/0/2)exit
S2(config)#erps-ring major_ring1
```



```
S2(config-erps-ring)#erps-instance 1
S2(config-erps-ring-inst-1)#description instance1
S2(config-erps-ring-inst-1)#rpl port1 owner
S2(config-erps-ring-inst-1)#non-revertive
S2(config-erps-ring-inst-1)#raps-mel 3
S2(config-erps-ring-inst-1)#protected-instance 2
S2(config-erps-ring-inst-1)#wtr-timer 8
S2(config-erps-ring-inst-1)#guard-timer 100
S2(config-erps-ring-inst-1)#holdoff-timer 5
S2(config-erps-ring-inst-1)# control-vlan 2
```

The configuration file of S3:

```
S3#config
S3(config)#erps-ring majior_ring1
S3(config)#spanning-tree mst configuration
S3(Config-Mstp-Region) instance 2 vlan 2;10-20
S3(Config-Mstp-Region)#exit
S3(config)#interface e1/0/1-2
S3(Config-If-Port-Range)#switchport mode trunk
S3(Config-If-Port-Range)#exit
S3(config)# interface e1/0/1
S3(config-if-ethernet1/0/1)erps-ring majior_ring1 port 0
S3(config-if-ethernet1/0/1)interface e1/0/2
S3(config-if-ethernet1/0/2)erps-ring majior_ring1 port 1
S3(config-if-ethernet1/0/2)exit
S3(config)#erps-ring majior_ring1
S3(config-erps-ring)#erps-instance 1
S3(config-erps-ring-inst-1)#description instance1
S3(config-erps-ring-inst-1)#rpl port1 neighbour
S3(config-erps-ring-inst-1)#raps-mel 3
S3(config-erps-ring-inst-1)#protected-instance 2
S3(config-erps-ring-inst-1)#wtr-timer 8
S3(config-erps-ring-inst-1)#guard-timer 100
S3(config-erps-ring-inst-1)#holdoff-timer 5
S3(config-erps-ring-inst-1)# control-vlan 2
```

The configuration file of S4:

```
S4#config
S4(config)#erps-ring majior_ring1
S4(config)#spanning-tree mst configuration
S4(Config-Mstp-Region) instance 2 vlan 2;10-20
S4(Config-Mstp-Region)#exit
S4(config)#interface e1/0/1-2
S4(Config-If-Port-Range)#switchport mode trunk
```

```

S4(Config-If-Port-Range)#exit
S4(config)# interface e1/0/1
S4(config-if-ethernet1/0/1)erps-ring major_ring1 port 0
S4(config-if-ethernet1/0/1)interface e1/0/2
S4(config-if-ethernet1/0/2)erps-ring major_ring1 port 1
S4(config-if-ethernet1/0/2)#exit
S4(config)#erps-ring major_ring1
S4(config-erps-ring)#erps-instance 1
S4(config-erps-ring-inst-1)#description instance 1
S4(config-erps-ring-inst-1)#raps-mel 3
S4(config-erps-ring-inst-1)#protected-instance 2
S4(config-erps-ring-inst-1)#wtr-timer 8
S4(config-erps-ring-inst-1)#guard-timer 100
S4(config-erps-ring-inst-1)#holdoff-timer 5
S4(config-erps-ring-inst-1)# control-vlan 2

```

Case 2:

ERPS multi-ring multi-instances have virtual channel cases

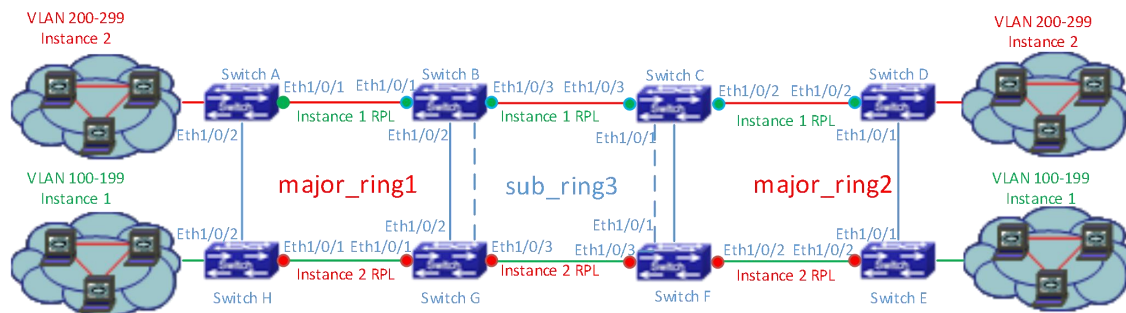

Figure 7-21 Configuration application of ERPS

As shown in Figure 7-21 above, it is an explanatory diagram of the configuration application of ERPS. ABGH, BCFG, and CDEF respectively form ring networks to provide Layer 2 redundant protection switching capabilities. The major ring, major_ring1, consists of ring nodes A, B, G, H and links A-B, B-G, G-H, A-H; the sub-ring, sub_ring3, consists of ring nodes B, C, F, G and links B-C, G-F; the major ring, major_ring2, consists of ring nodes C, D, E, F and links C-D, D-E, E-F, F-C.

In order to prevent the packets in VLAN100 ~ VLAN199 and VLAN200 ~ VLAN299 from generating loops, ERPS protocol is deployed on the devices composing the ring network. The data forwarding path of VLAN100-199 users accessed through switch H is H-G-F-E, and the data forwarding path of VLAN200-299 users accessed through switch A is A-B-C-D. Since between BG and CF in the subring belong to the main ring major_ring1 and major_ring2, respectively, the subring sub_ring3 is not a continuous ring, so virtual channel connection is needed. In order to realize the Ethernet loop switching protection, the configuration can be carried out as follows.

1. Configuration ideas

Configure ERPS loop redundancy protection as follows:

Create the ERPS ring major_ring1 and configure the ring member ports.

Configure instance 1 on the ERPS ring major_ring1, and configure the protection instance, member port role, timer, and control VLAN.

Configure instance 2 on the ERPS ring major_ring1, and configure the protection instance, member port role, timer, and control VLAN.

Create the ERPS subring sub_ring3 and configure the ring member ports.

Configure instance 1 on the ERPS subring sub_ring3, and configure the protection instance, member port role, timer, and control VLAN.

Configure instance 2 on the ERPS subring sub_ring3, and configure the protection instance, member port role, timer, and control VLAN.

Configure virtual channels on ERPS subrings

Create the major_ring2 ERPS ring and configure the ring member ports.

Configure instance 1 on the ERPS ring major_ring2, and configure the protection instance, member port role, timer, and control VLAN.

Configure instance 2 on the ERPS ring major_ring2, and configure the protection instance, member port role, timer, and control VLAN.

2. Configuration Steps

In the case of switchA and B, the configuration steps are as follows

Step 1 Create instance 1 on switch A and switch B, mapping VLAN 10-12; 100-199, create instance 2, map VLAN 20-22; 200-299. The correspondence is as follows:

			control vlan
ERPS ring	major_ring1	erps instance1	10
		erps instance 2	20
	major_ring2	erps instance 1	12
		erps instance 2	22
	sub_ring3	erps instance 1	11
		erps instance 2	21

Base configuration:

It is configured on the ports of all ERPS rings, in order to prevent packets without tags the ring can be configured

```
switchport discard packet untag
```

```
Configure the allowed vlan
```

```
switchport mode trunk
```

```
switchport trunk allowed vlan 10-12;20-22;100-299
```

Configure mst instance mapping on all devices

!

```
spanning-tree mst configuration
```

```
instance 0 vlan 1-9;13-19;23-99;300-4094
```

```
instance 1 vlan 10-12;100-199
```

```
instance 2 vlan 20-22;200-299
```

```
exit
```

!

config switch A.

```
A#config
A(config)#vlan 10-12;20-22;100-299
A(config)#spanning-tree mst configuration
A(config-mstp-region)#instance 1 vlan 10-12;100-199
A(config-mstp-region)#instance 2 vlan 20-22;200-299
A(config-mstp-region)#exit
```

Switch B is configured the same as switch A.

Step 2 Create the ERPS ring major_ring1 on switch A and B and configure the member port information. Others are the default configuration: support V2 version, main ring closure type, monitoring port physical state.

```
A(config)#erps-ring major_ring1
A(config-erps-ring)#exit
A(config)#interface e1/0/1
A(config-if-ethernet1/0/1)#erps-ring major_ring1 port0
A(config-if-ethernet1/0/1)#interface e1/0/2
A(config-if-ethernet1/0/2)#erps-ring major_ring1 port1
```

```
B(config)#erps-ring major_ring1
B(config-erps-ring)#exit
B(config)#interface e1/0/1
B(config-if-ethernet1/0/1)#erps-ring major_ring1 port0
B(config-if-ethernet1/0/1)#interface e1/0/2
B(config-if-ethernet1/0/2)#erps-ring major_ring1 port1
```

On Switch B, create the sub_ring3, and configure the member port information. The ERPS ring is configured on sub_ring3 to be of subring open type with virtual channel type.

```
B(config)#erps-ring sub_ring3
Configure the ERPS ring to be open ring
B(config-erps-ring)#open-ring
Configure the ERPS ring have virtual channel.
B(config-erps-ring)#raps-virtual-channel with
B(config-erps-ring)#exit
B(config-if-ethernet1/0/2)#interface e1/0/3
Configure e1/0/3 as port0 on sub_ring3 and no port1
B(config-if-ethernet1/0/3)#erps-ring sub_ring3 port0 port1-none
```

Step 3 Configure the ERPS ring instance, configure the protection instance, port role, ERPS ring instance name, protection instance, and selective configuration, R-APS level, timer and other information, and finally configure the control VLAN. The e1/0/1 port of

switch A is configured as RPL Owner in erps instance 1 of ring major_ring1, and the e1/0/1 port of switch B is configured as RPL Neighbour in erps instance 1 of ring major_ring1. Add ERPS instance 2.

```
A(config)#erps-ring major_ring1
A(config-erps-ring)#erps-instance 1
A(config-erps-ring-inst-1)#rpl port0 owner
A(config-erps-ring-inst-1)#protected-instance 1
A(config-erps-ring-inst-1)#control-vlan 10
A(config-erps-ring-inst-1)#exit
Configure ERPS instance 2
A(config-erps-ring)#erps-instance 2
A(config-erps-ring-inst-2)#protected-instance 2
A(config-erps-ring-inst-2)#control-vlan 20
A(config-erps-ring-inst-1)#exit
```

ERPS instance1 and instance2 are created on switch B, respectively.

```
B(config)#erps-ring major_ring1
B(config-erps-ring)#erps-instance 1
B(config-erps-ring-inst-1)#rpl port0 owner
B(config-erps-ring-inst-1)#protected-instance 1
B(config-erps-ring-inst-1)#control-vlan 10
B(config-erps-ring-inst-1)#exit
Configure ERPS instance 2
B(config-erps-ring)#erps-instance 2
B(config-erps-ring-inst-2)#protected-instance 2
B(config-erps-ring-inst-2)#control-vlan 20
B(config-erps-ring-inst-1)#exit
```

Step 4 Configure ERPS instance 1 and ERPS instance 2 in subring sub_ring3 on switch B

```
B(config)#erps-ring sub_ring3
B(config-erps-ring)#erps-instance 1
B(config-erps-ring-inst-1)#rpl port0 owner
B(config-erps-ring-inst-1)#protected-instance 1
B(config-erps-ring-inst-1)#control-vlan 11
B(config-erps-ring-inst-1)#exit
B(config-erps-ring)#erps-instance 2
B(config-erps-ring-inst-1)#protected-instance 2
B(config-erps-ring-inst-1)#control-vlan 21
B(config-erps-ring-inst-1)#exit
B(config-erps-ring)#exit
```

Other device configuration files:

Switch C:

```
vlan 1;10-12;20-22;100-299
```

```
!  
erps-ring major_ring2  
  erps-instance 1  
    rpl port0 owner  
    protected-instance 1  
    control-vlan 12  
  exit  
  erps-instance 2  
    protected-instance 2  
    control-vlan 22  
  exit  
!  
erps-ring sub_ring3  
  open-ring  
  raps-virtual-channel with  
  erps-instance 1  
    rpl port0 neighbour  
    protected-instance 1  
    control-vlan 11  
  exit  
  erps-instance 2  
    protected-instance 2  
    control-vlan 21  
  exit  
!  
Interface Ethernet1/0/1  
  switchport discard packet untag  
  switchport mode trunk  
  switchport trunk allowed vlan 10-12;20-22;100-299  
  erps-ring major_ring2 port1  
!  
Interface Ethernet1/0/2  
  switchport discard packet untag  
  switchport mode trunk  
  switchport trunk allowed vlan 10-12;20-22;100-299  
  erps-ring major_ring2 port0  
!  
Interface Ethernet1/0/3  
  switchport discard packet untag  
  switchport mode trunk  
  switchport trunk allowed vlan 10-12;20-22;100-299  
  erps-ring sub_ring3 port0 port1-none  
!
```

```
Switch D:
vlan 1;10-12;20-22;100-299
!
erps-ring major_ring2
  erps-instance 1
    rpl port0 neighbour
    protected-instance 1
    control-vlan 12
  exit
  erps-instance 2
    protected-instance 2
    control-vlan 22
  exit
!
Interface Ethernet1/0/1
  switchport discard packet untag
  switchport mode trunk
  switchport trunk allowed vlan 10-12;20-22;100-299
  erps-ring major_ring2 port1
!
Interface Ethernet1/0/2
  switchport discard packet untag
  switchport mode trunk
  switchport trunk allowed vlan 10-12;20-22;100-299
  erps-ring major_ring2 port0
!
```

```
Switch E:
vlan 1;10-12;20-22;100-299
!
erps-ring major_ring2
  erps-instance 1
    protected-instance 1
    control-vlan 12
  exit
  erps-instance 2
    rpl port0 neighbour
    protected-instance 2
    control-vlan 22
  exit
!
Interface Ethernet1/0/1
  switchport discard packet untag
  switchport mode trunk
```

```
switchport trunk allowed vlan 10-12;20-22;100-299
erps-ring major_ring2 port1
!
Interface Ethernet1/0/2
switchport discard packet untag
switchport mode trunk
switchport trunk allowed vlan 10-12;20-22;100-299
erps-ring major_ring2 port0
!
```

Switch F:

```
vlan 1;10-12;20-22;100-299
```

```
!
```

```
erps-ring major_ring2
```

```
erps-instance 1
```

```
protected-instance 1
```

```
control-vlan 12
```

```
exit
```

```
erps-instance 2
```

```
rpl port0 owner
```

```
protected-instance 2
```

```
control-vlan 22
```

```
exit
```

```
!
```

```
erps-ring sub_ring3
```

```
open-ring
```

```
raps-virtual-channel with
```

```
erps-instance 1
```

```
protected-instance 1
```

```
control-vlan 11
```

```
exit
```

```
erps-instance 2
```

```
rpl port0 neighbour
```

```
protected-instance 2
```

```
control-vlan 21
```

```
exit
```

```
!
```

```
Interface Ethernet1/0/1
```

```
switchport discard packet untag
```

```
switchport mode trunk
```

```
switchport trunk allowed vlan 10-12;20-22;100-299
```

```
erps-ring major_ring2 port1
```

```
!
```

```
Interface Ethernet1/0/2
```



```
switchport discard packet untag
switchport mode trunk
switchport trunk allowed vlan 10-12;20-22;100-299
erps-ring major_ring2 port0
!
Interface Ethernet1/0/3
switchport discard packet untag
switchport mode trunk
switchport trunk allowed vlan 10-12;20-22;100-299
erps-ring sub_ring3 port0 port1-none
!
```

Switch G:

```
vlan 1;10-12;20-22;100-299
!
erps-ring major_ring1
erps-instance 1
  protected-instance 1
  control-vlan 10
  exit
erps-instance 2
  rpl port0 neighbour
  protected-instance 2
  control-vlan 20
  exit
!
erps-ring sub_ring3
open-ring
raps-virtual-channel with
erps-instance 1
  protected-instance 1
  control-vlan 11
  exit
erps-instance 2
  rpl port0 owner
  protected-instance 2
  control-vlan 21
  exit
!
Interface Ethernet1/0/1
switchport discard packet untag
switchport mode trunk
switchport trunk allowed vlan 10-12;20-22;100-299
erps-ring major_ring1 port0
```

```
!  
Interface Ethernet1/0/2  
  switchport discard packet untag  
  switchport mode trunk  
  switchport trunk allowed vlan 10-12;20-22;100-299  
  erps-ring major_ring1 port1  
!  
Interface Ethernet1/0/3  
  switchport discard packet untag  
  switchport mode trunk  
  switchport trunk allowed vlan 10-12;20-22;100-299  
  erps-ring sub_ring3 port0 port1-none  
!
```

```
Switch H:  
vlan 1;10-12;20-22;100-299
```

```
!  
erps-ring major_ring1  
  erps-instance 1  
    protected-instance 1  
    control-vlan 10  
  exit  
  erps-instance 2  
    rpl port0 owner  
    protected-instance 2  
    control-vlan 20  
  exit
```

```
!  
Interface Ethernet1/0/1  
  switchport discard packet untag  
  switchport mode trunk  
  switchport trunk allowed vlan 10-12;20-22;100-299  
  erps-ring major_ring1 port0  
!  
Interface Ethernet1/0/2  
  switchport discard packet untag  
  switchport mode trunk  
  switchport trunk allowed vlan 10-12;20-22;100-299  
  erps-ring major_ring1 port1  
!
```

```
Case 3:  
Multi-loop multi-instance without virtual channels
```

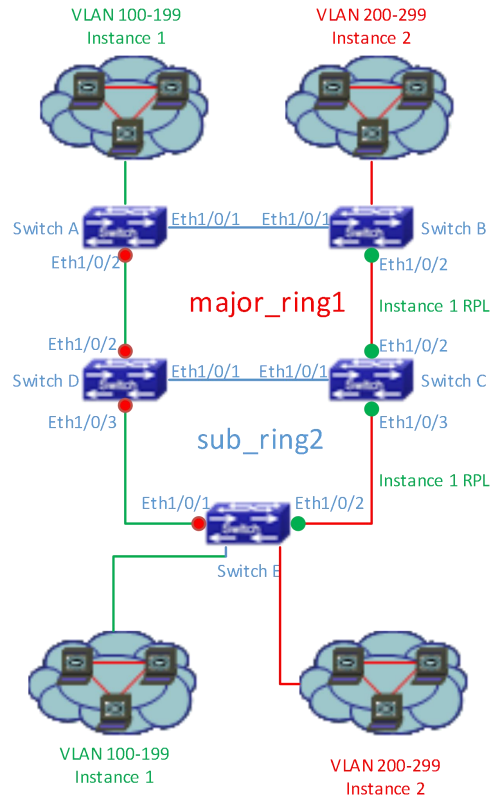

Figure 7-21 Configuration application of ERPS

As shown in the figure 7-22 above is an illustration of the configuration application of ERPS. ABCD and DCE respectively form a ring network to provide a two-layer redundant protection switching function. major_ring1 consists of links A, B, C, D and links A-B, B-C, C-D, D-A; sub_ring2 consists of link points C, D, E and links C-e, e-d. Different from Case 2, ERPS packets in sub_ring2 can be transmitted to all link points, so there is no need to configure virtual channels. Configuration for all devices

spanning-tree mst configuration

```
instance 0 vlan 1-9;12-19;22-99;300-4094
```

```
instance 1 vlan 10-11;100-199
```

```
instance 2 vlan 20-21;200-299
```

```
exit
```

```
!
```

```
vlan 10-11;20-21;100-299
```

```
!
```

Switch A:

```
erps-ring major_ring1
```

```
erps-instance 1
```

```
protected-instance 1
```

```
control-vlan 10
```

```
exit
```

```
erps-instance 2
```

```
rpl port0 owner
```

```
protected-instance 2
control-vlan 20
exit
!
Interface Ethernet1/0/1
switchport discard packet untag
switchport mode trunk
switchport trunk allowed vlan 10-11;20-21;100-299
erps-ring major_ring1 port1
!
Interface Ethernet1/0/2
switchport discard packet untag
switchport mode trunk
switchport trunk allowed vlan 10-11;20-21;100-299
erps-ring major_ring1 port0
!

Switch B:
erps-ring major_ring1
erps-instance 1
rpl port0 owner
protected-instance 1
control-vlan 10
exit
erps-instance 2
protected-instance 2
control-vlan 20
exit
!
Interface Ethernet1/0/1
switchport discard packet untag
switchport mode trunk
switchport trunk allowed vlan 10-11;20-21;100-299
erps-ring major_ring1 port1
!
Interface Ethernet1/0/2
switchport discard packet untag
switchport mode trunk
switchport trunk allowed vlan 10-11;20-21;100-299
erps-ring major_ring1 port0
!
```

Switch C:

```
erps-ring major_ring1
  erps-instance 1
    rpl port0 neighbour
    protected-instance 1
    control-vlan 10
  exit
  erps-instance 2
    protected-instance 2
    control-vlan 20
  exit
!
erps-ring sub_ring2
  open-ring
  erps-instance 1
    rpl port0 owner
    protected-instance 1
    control-vlan 11
  exit
  erps-instance 2
    protected-instance 2
    control-vlan 21
  exit
!
Interface Ethernet1/0/1
  switchport discard packet untag
  switchport mode trunk
  switchport trunk allowed vlan 10-12;20-21;100-299
  erps-ring major_ring1 port1
!
Interface Ethernet1/0/2
  switchport discard packet untag
  switchport mode trunk
  switchport trunk allowed vlan 10-12;20-21;100-299
  erps-ring major_ring1 port0
!
Interface Ethernet1/0/3
  switchport discard packet untag
  switchport mode trunk
  switchport trunk allowed vlan 10-12;20-21;100-299
  erps-ring sub_ring2 port0 port1-none
!

Switch D:
erps-ring major_ring1
```

```
erps-instance 1
  protected-instance 1
  control-vlan 10
  exit
erps-instance 2
  rpl port0 neighbour
  protected-instance 2
  control-vlan 20
  exit
!
erps-ring sub_ring2
  open-ring
  erps-instance 1
    protected-instance 1
    control-vlan 11
    exit
  erps-instance 2
    rpl port0 owner
    protected-instance 2
    control-vlan 21
    exit
!
Interface Ethernet1/0/1
  switchport discard packet untag
  switchport mode trunk
  switchport trunk allowed vlan 10-11;20-21;100-299
  erps-ring major_ring1 port1
!
Interface Ethernet1/0/2
  switchport discard packet untag
  switchport mode trunk
  switchport trunk allowed vlan 10-11;20-21;100-299
  erps-ring major_ring1 port0
!
Interface Ethernet1/0/3
  switchport discard packet untag
  switchport mode trunk
  switchport trunk allowed vlan 10-11;20-21;100-299
  erps-ring sub_ring2 port0 port1-none
!

Switch E:
erps-ring sub_ring2
  open-ring
```

```
erps-instance 1
  rpl port0 neighbour
  protected-instance 1
  control-vlan 11
  exit
erps-instance 2
  rpl port1 neighbour
  protected-instance 2
  control-vlan 21
  exit
!
Interface Ethernet1/0/1
  switchport discard packet untag
  switchport mode trunk
  switchport trunk allowed vlan 10-11;20-21;100-299
  erps-ring sub_ring2 port1
!
Interface Ethernet1/0/2
  switchport discard packet untag
  switchport mode trunk
  switchport trunk allowed vlan 10-11;20-21;100-299
  erps-ring sub_ring2 port0
!
```

8.6.4 ERPS Troubleshooting

If the configured ERPS loop cannot achieve the Ethernet loop switching protection, check if it was wrong with the following reasons:

- ☞ Check if the basic configuration is correct and check if the protection instance of every node, control-vlan, wtr-timer, guard-timer and raps-mel are consistent.
- ☞ Check if the vlan that user data flow is in is not the same one that control-vlan is in. In the ERPS loop instance, control vlan is only used to transmit ERPS protocol packet but not the user business packet; it improves the security of ERPS protocol. User ensures the uniqueness of the configuration. This VLAN is as the vlan tag when sending R-APS packet. In the instance, the protection VLAN configuration of all nodes must be consistent.
- ☞ We suggest the port which user configured on ERPS node is trunk port and ensure that the vlan and control vlan that data packet is in are in the protection instance and ERPS only protect the data and protocol packet in the instance. For instance, the switch enables a protocol (CFM, EFM, Layer3 interface) and it makes the switch send the protocol packet out. Then, if the vlan ID which sends the packet is not in the protection instance, there will

be the loop in the topology.

- ☞ If configure the port status test method as fastlink, the hardware must support fastlink function. Break off the notification of port status changing; disable the mac soft study function at the same time.
- ☞ If it is configured associating with CFM, the hardware must support CC function and it can achieve the ability of CCM sending packet in 3.3m

Chapter 9 Debugging and Diagnosis Configuration

9.1 Monitor and Debug

When the users configures the switch, they will need to verify whether the configurations are correct and the switch is operating as expected, and in network failure, the users will also need to diagnostic the problem. Switch provides various debug commands including ping, telnet, show and debug, etc. to help the users to check system configuration, operating status and locate problem causes.

9.1.1 Ping

Ping command is mainly used for sending ICMP query packet from the switches to remote devices, also for check the accessibility between the switch and the remote device. Refer to the Ping command chapter in the Command Manual for explanations of various parameters and options of the Ping command.

9.1.2 Ping6

Ping6 command is mainly used by the switch to send ICMPv6 query packet to the remote equipment, verifying the accessibility between the switch and the remote equipment. Options and explanations of the parameters of the Ping6 command please refer to Ping6 command chapter in the command manual.

9.1.3 Traceroute

Traceroute command is for testing the gateways through which the data packets travel from the source device to the destination device, so to check the network accessibility and locate the network failure.

Execution procedure of the Traceroute command consists of: first a data packet with TTL at 1 is sent to the destination address, if the first hop returns an ICMP error message to inform this packet can not be sent (due to TTL timeout), a data packet with TTL at 2 will be sent. Also the send hop may be a TTL timeout return, but the procedure will carries on till the data packet is sent to its destination. These procedures is for recording every source address which returned ICMP TTL timeout message, so to describe a path the IP data packets traveled to reach the destination.

Traceroute Options and explanations of the parameters of the Traceroute command please refer to traceroute command chapter in the command manual.

9.1.4 Traceroute6

The Traceroute6 function is used on testing the gateways passed through by the data packets from the source equipment to the destination equipment, to verify the accessibility and locate the network failure. The principle of the Traceroute6 under IPv6 is the same as that under IPv4, which adopts the hop limit field of the ICMPv6 and IPv6 header. First, Traceroute6 sends an IPv6 datagram (including source address, destination address and packet sent time) whose HOPLIMIT is set to 1. When first route on the path receives this datagram, it minus the HOPLIMIT by 1 and the HOPLIMIT is now 0. So the router will discard this datagram and returns with a 「ICMPv6 time exceeded」 message (including the source address of the IPv6 packet, all content in the IPv6 packet and the IPv6 address of the router). Upon receiving this message, the Traceroute6 sends another datagram of which the HOPLIMIT is increased to 2 so to discover the second router. Plus 1 to the HOPLIMIT every time to discover another router, the Traceroute6 repeat this action till certain datagram reaches the destination.

Traceroute6 Options and explanations of the parameters of the Traceroute6 command please refer to traceroute6 command chapter in the command manual.

9.1.5 Show

show command is used to display information about the system, port and protocol operation. This part introduces the **show** command that displays system information, other **show** commands will be discussed in other chapters.

Command	Explanation
Admin Mode	
show debugging	Display the debugging state.
show flash	Display the files and the sizes saved in the flash.
show history	Display the recent user input history command.
show history all-users [detail]	Show the recent command history of all users. Use clear history all-users command to clear the command history of all users saved by the system, the max history number can be set by history all-users max-length command.
show memory	Display content in specified memory area.
show running-config	Display the switch parameter configuration validating at current operation state.
show running-config current-mode	Show the configuration under the current mode.
show startup-config	Display the switch parameter configuration written in the Flash Memory at current operation state, which is normally the configuration file applied in next time the switch starts up.
show switchport interface [ethernet <IFNAME>]	Display the VLAN port mode and the belonging VLAN number of the switch as well as the Trunk

	port information.
show tcp show tcp ipv6	Display the TCP connection status established currently on the switch.
show udp show udp ipv6	Display the UDP connection status established currently on the switch.
show telnet login	Display the information of the Telnet client which currently establishes a Telnet connection with the switch.
show tech-support	Display the operation information and the state of each task running on the switch. It is used by the technicians to diagnose whether the switch operates properly.
show version	Display the version of the switch.
show temperature	Show CPU temperature of the switch.
show fan	This command is not supported by switch.

9.1.6 Debug

All the protocols switch supports have their corresponding debug commands. The users can use the information from debug commands for troubleshooting. Debug commands for their corresponding protocols will be introduced in the later chapters.

9.2 Reload Switch after Specified Time

9.2.1 Introduce to Reload Switch after Specified Time

Reload switch after specified time is to reboot the switch without shutdown its power after a specified period of time, usually when updating the switch version. The switch can be rebooted after a period of time instead of immediately after its version being updated successfully.

9.2.2 Reload Switch after Specified Time Task List

1. Reload switch after specified time

Command	Explanation
Admin mode	
reload after {<HH:MM:SS>} [days <days>]}	Reload the switch after a specified time period.
reload cancel	Cancel the specified time period to reload the switch.

9.3 Debugging and Diagnosis for Packets Received and Sent by CPU

9.3.1 Introduction to Debugging and Diagnosis for Packets Received and Sent by CPU

The following commands are used to debug and diagnose the packets received and sent by CPU, and are supposed to be used with the help of the technical support.

9.3.2 Debugging and Diagnosis for Packets Received and Sent by CPU Task List

Command	Explanation
Global Mode	
cpu-rx-ratelimit total <packets> no cpu-rx-ratelimit total	Set the total rate of the CPU receiving packets, the no command sets the total rate of the CPU receiving packets to default.
cpu-rx-ratelimit protocol <protocol-type> <packets> no cpu-rx-ratelimit protocol [<protocol-type>]	Set the max rate of the CPU receiving packets of the protocol type, the no command set the max rate to default.
clear cpu-rx-stat protocol [<protocol-type>]	Clear the statistics of the CPU received packets of the protocol type.
Admin Mode	
show cpu-rx protocol [<protocol-type>]	Show the information of the CPU received packets of the protocol type.
debug driver {receive send} [interface {<interface-name> all}] [protocol {<protocol-type> discard all}] [detail]	Turn on the showing of the CPU receiving or sending packet informations.
no debug driver {receive send}	Turn off the showing of the CPU receiving or sending packet informations.

Command	Explanation
---------	-------------

Admin Mode	
protocol filter {protocol-type}	Turn on/off the treatment of the named protocol packets, the named protocol contains:
no Protocol filter {protocol-type}	{arp bgp dhcp dhcpv6 hsrp http igmp ip ldp mpls ospf pim rip snmp telnet vrrp}

9.4 Info-center

9.4.1 Overview

9.4.1.1 Basic Concepts

The information center is a set of mechanisms that outputs system information (hereafter referred to as the information source).

Users need to configure for the output direction, and enable the corresponding output direction, and set matching information conditions to output the desired log information, the configuration process is simple and flexible.

9.4.1.2 Information sources

There are eight levels of severity for information sources.

Table 1-1

Grade num	Grade name	Description
1	emergencies	Fatal error
2	alerts	Errors to be corrected immediately
3	critical	Critical Error
4	errors	Concerned but not critical errors
5	warnings	Warning, there may be some error
6	notifications	Note the information
7	informational	General information
8	debugging	Debugging information

9.4.1.3 Output direction

Currently, 16 output directions are supported, as shown in Table 1-2:

Table 1-2

Output direction	Description
console	Control panel

monitor	monitor terminal
loghost <1-8>	Log host
trapbuffer	Alarm buffer
logbuffer	Log buffer
logfile <1-4>	Log file

The Settings for the output directions are independent of each other, but the information center needs to be opened before the settings take effect.

9.4.1.4 Source information format

The format of the source information is as follows:

```
<priority>timestamp sysname module/level/digest:content
```

The angle brackets (<>), spaces, slashes (/), and colon (:) are required in the above format when configuring the log prefix; where angle brackets are valid only when the output direction is the log host.

An example of the log format to be output to the log host is shown below:

```
<188>Sep 28 15:33:46:235 2005 MyDevice SHELL/5/LOGIN: Console login from con0
```

Another example of the log format without prefix is shown below:

```
Console login from con0
```

Each field is described in detail below:

1) Priority

The priority is calculated as follows: $\text{facility} * 8 + \text{severity} - 1$.

Facility can be local0 ~ local7, default is local7. The value is 16-23.

Severity ranges from 1 to 8. For more information about severity, refer to Table 1-1.

There is no character between the priority and the timestamp. The priority is valid only when the information is sent to the log host.

The origin of facility is worth mentioning. Facility is a unique attribute when information is output to the log host, and has no meaning for other output directions. Its value local0 ~ local7 comes from the log type which the early syslog protocol defined for the UNIX log host. All types are as follows:

Table 1-3

facility	code
kernel messages	0
user-level messages	1
mail system	2
system daemons	3
security/authorization messages (note 1)	4

messages generated internally by syslogd	5
line printer subsystem	6
network news subsystem	7
UUCP subsystem	8
clock daemon (note 2)	9
security/authorization messages (note 1)	10
FTP daemon	11
NTP subsystem	12
log audit (note 1)	13
log alert (note 1)	14
clock daemon (note 2)	15
local use 0 (local0)	16
local use 1 (local1)	17
local use 2 (local2)	18
local use 3 (local3)	19
local use 4 (local4)	20
local use 5 (local5)	21
local use 6 (local6)	22
local use 7 (local7)	23

As you can see, local0 ~ local7 is reserved for local users, the value is 16 to 23.

2) Timestamp

The timestamp records the time when the system information is generated, making it easy for the user to view and locate system events. The timestamp and host name are separated by a space.

Date mode

mmm + space + dd + space + hh + colon + mm + colon + ss + colon + sss+ space+
yyyy

mmm = Jan | Feb | Mar | Apr | May | Jun | Jul | Aug | Sep | Oct | Nov | Dec

Indicates month

dd = 1~31, Indicates the date, if the value is 1 to 9, 0 should be added in front of the number. For example, 1 to be converted to "01".

hh = 0 ~ 23, Indicates hours

mm = 0 ~ 59, Indicates minutes

ss = 0 ~ 59 Indicates seconds

sss = 0 ~ 999 Indicates milliseconds

yyyy = 1970 ~ 9999 Indicates year

3) Sysname

The sysname is the system name of the machine.

The sysname and module name are separated by a space.

4) module

This field indicates the name of the module that generated the message.

The module and the level are separated by a slash (/).

5) Severity

System information is divided into three categories: log, debug and alarm. According to the urgency, each type of information is divided into eight levels. The smaller information level value, the higher urgency level.

The rule that the system uses to filter information is to prohibit the output of information whose information level is greater than threshold.

When the value of the information level is 1, the system will only output emergencies information;

When the value of the information level is 8, the system outputs all levels of information;

If the configuration filtering method is an exact match, the system only outputs information at the design level.

The level is separated from the digest by a slash (/).

6) digest

A message digest is a string of up to 32 characters that indicates the content of the message.

The digest is separated from the content by a colon (:).

7) content

9.4.2 The content indicates the specific contents of the system information.Configure Sequence

1. Set the global enable of the information center
2. Set the output direction of the information center to enable
3. Set the log information prefix switch
4. Set the log information matching conditions
5. Configure the IP and facility of the log host
6. Configure the number of log files and access path
7. Configure to record user operation commands
8. Delete logs recorded by logbuffer or trapbuffer
9. View the area that supports storing files
10. Configure onekey collection

1. Set the global enable of the information center

Command	Description
Global configuration mode	
info-center enable	Set the global enable of the information center
no info-center enable	Set the global disable of the information center

2. Set the output direction of the information center to enable

Command	Description
Global configuration mode	
info-center (console logbuffer monitor trapbuffer)	Set the output direction of the

output-enable info-center (logfile <1-4> loghost <1-8>) output-enable (member <1-4>)	information center to enable
no info-center (console logbuffer monitor trapbuffer) output-enable no info-center (logfile <1-4> loghost <1-8>) output-enable (member <1-16>)	Set the output direction of the information center to disable

3. Set the log information prefix switch

Command	Description
Global configuration mode	
info-center (console logbuffer monitor trapbuffer) prefix (on off) info-center (logfile <1-4> loghost <1-8>) prefix (on off) (member <1-16>)	Set the log information prefix switch

4. Set the log information matching conditions

Command	Description
Global configuration mode	
info-center (console logbuffer monitor trapbuffer) match level (emergencies alerts critical errors warnings notifications informational debugging) (exact) (keyword WORD) info-center (logfile <1-4> loghost <1-8>) match level (emergencies alerts critical errors warnings notifications informational debugging) (exact) (keyword WORD) (member <1-16>)	Set the log information matching conditions
no info-center (console logbuffer monitor trapbuffer) match no info-center (logfile <1-4> loghost <1-8>) match (member <1-16>)	Delete the log information matching conditions

5. Configure the IP and facility of the log host

Command	Description
Global configuration mode	
info-center loghost <1-8> config (A.B.C.D X:X::X:X) facility (local0 local1 local2 local3 local4 local5 local6 local7) (member <1-16>)	Configure the IP and facility of the log host
no info-center loghost <1-8> config (member <1-16>)	Delete the IP and facility of the log host

6. Configure the number of log files and access path

Command	Description
Global configuration mode	
info-center logfile <1-4> config count <1-40960> (flash usb nandflash) WORD (member <1-16>)	Configure the number of log files and access path
no info-center logfile <1-4> config (member <1-16>)	Delete the number of log files and access path

7. Configure to record user operation commands

Command	Description
Global configuration mode	
info-center (logbuffer logfile <1-4> loghost <1-8>) record-cmd	Configure to record user operation commands
no info-center (logbuffer logfile <1-4> loghost <1-8>) record-cmd	Delete to record user operation commands

8. Delete logs recorded by logbuffer or trapbuffer

Command	Description
Global configuration mode	
info-center clear trapbuffer	Delete logs recorded by trapbuffer
info-center clear logbuffer (member <1-16>)	Delete logs recorded by logbuffer

9. View the area that supports storing files

Command	Description
Global configuration mode	
info-center list all disk	View the area that supports storing files

10. Configure onekey collection

Command	Description
Global configuration mode	
info-center save all (((flash usb nandflash) WORD))	Configure onekey collection

9.4.3 Instructions

9.4.3.1 console output log

Example 1, configuring the console is allowed to output the logs with prefix, and matching level of debugging or above.

The configuration steps are as follows:

```
Switch(config)#info-center console output-enable
Switch(config)#info-center console prefix on
Switch(config)#info-center console match level debugging
```

9.4.3.2 monitor output log

Example 2, configuring the monitor is allowed to output the logs without prefix, and matching level of warnings only.

The configuration steps are as follows:

```
Switch(config)#info-center monitor output-enable
Switch(config)#info-center monitor prefix off
Switch(config)#info-center monitor match level warnings exact
```

9.4.3.3 logbuffer output log

Example 3, configuring the logbuffer is allowed to output the logs with prefix, and matching level of debugging or above, also matching regular expression DEVSM.

The configuration steps are as follows:

```
Switch(config)#info-center logbuffer output-enable
Switch(config)#info-center logbuffer prefix on
Switch(config)#info-center logbuffer match level debugging keyword DEVSM
```

9.4.3.4 trapbuffer output log

Example 4, configuring the trapbuffer is allowed to output the logs with prefix, and matching level of warnings only, also matching regular expression DEVSM.

The configuration steps are as follows:

```
Switch(config)#info-center trapbuffer output-enable
Switch(config)#info-center trapbuffer prefix on
Switch(config)#info-center trapbuffer match level warnings exact keyword DEVSM
```

9.4.3.5 loghost output log

Example 5, configuring the loghost 1 allowed to output the logs with prefix, and matching level of debugging or above, also the log host's IP is 192.168.1.11, facility is local0.

The configuration steps in vsf mode are as follows:

```
Switch(config)#info-center loghost 1 output-enable member 1
Switch(config)#info-center loghost 1 prefix on member 1
```

```
Switch(config)#info-center loghost 1 match level debugging member 1
Switch(config)#info-center loghost 1 config 192.168.1.11 facility local0 member 1
```

The configuration steps in stand-alone mode are as follows:

```
Switch(config)#info-center loghost 1 output-enable
Switch(config)#info-center loghost 1 prefix on
Switch(config)#info-center loghost 1 match level debugging
Switch(config)#info-center loghost 1 config 192.168.1.11 facility local0
```

9.4.3.6 logfile output log

Example 6, configuring the logfile 1 is allowed to output the logs with prefix, and matching level of debugging or above, also up to 2000 logs are allowed. The storage disk is flash, the file name is file1.log.

The configuration steps in vsf mode are as follows:

```
Switch(config)#info-center logfile 1 output-enable member 1
Switch(config)#info-center logfile 1 prefix on member 1
Switch(config)#info-center logfile 1 match level debugging member 1
Switch(config)#info-center logfile 1 config count 2000 flash file1.log member 1
```

The configuration steps in stand-alone mode are as follows:

```
Switch(config)#info-center logfile 1 output-enable
Switch(config)#info-center logfile 1 prefix on
Switch(config)#info-center logfile 1 match level debugging
Switch(config)#info-center logfile 1 config count 2000 flash file1.log
```

9.4.3.7 record user operation commands

Example 7, configuring the logbuffer is allowed to record user operation commands.

The configuration steps are as follows:

```
Switch(config)#info-center logbuffer output-enable
Switch(config)#info-center logbuffer record-cmd
```

9.4.3.8 Delete logs recorded by logbuffer or trapbuffer

Example 8, delete logs recorded by logbuffer or trapbuffer.

The configuration steps are as follows:

```
Switch(config)#info-center clear logbuffer
Switch(config)#info-center clear trapbuffer
```

9.4.3.9 View the area that supports storing files

Example 9, view the area that supports storing files.

The configuration steps are as follows:

```
Switch(config)#info-center list all disk
flash:
usb:
nandflash:
```

9.4.3.10 Configure onekey collection

Example 10, configure onekey collection.

The configuration steps are as follows:

```
Switch(config)#info-center list all disk
*****Now saving Master card(member 1)*****
Now saving infocenter all configuration, please wait..
Now saving infocenter logbuffer content, please wait..
Now saving infocenter trapbuffer content, please wait..
*****Master card(member 1) saving finished!*****

*****Now saving Slave card(member 2)*****
Now saving infocenter logbuffer content, please wait..
*****Slave card(member 2) saving finished!*****
```

9.4.4 Erratum

- Configuring the matching level of log information is valid for subsequent logs, and the previously saved log information remains unchanged.
- Disk capacity is limited, and when the maximum number of logs in disk is reached, the new log information replaces the old log.
- The information center is globally enabled by default, and all current configurations of the information center can be displayed using the show info-center config command.

9.5 Mirror

9.5.1 Introduction to Mirror

Mirror functions include port mirror function, flow mirror function.

Port mirror refers to the duplication of data frames sent/received on a port to another port. The duplicated port is referred to as mirror source port and the duplicating port is referred to as mirror destination port. A protocol analyzer (such as Sniffer) or a RMON monitor will be connected at mirror destination port to monitor and manage the network, and diagnose the problems in the network.

Flow mirror function means that the switch exactly copies the data frames received or by the specified rule of a port to another port. The flow mirror will take effect only the specified rule is permit.

A chassis switch supports at most 4 mirror destination ports, each boardcard allows a source or destination port of a mirror session. At present, each box switch can set many mirror sessions. There is no limitation on mirror source ports, one port or several ports is allowed. When there are more than one source ports, they can be in the same VLAN or in different VLAN. The source port and destination port can be in different VLAN.

9.5.2 Mirror Configuration Task List

1. Specify mirror destination port
2. Specify mirror source port
3. Specify flow mirror source

1. Specify mirror destination port

Command	Explanation
Global mode	
monitor session <session> destination interface <interface-number> no monitor session <session> destination interface <interface-number>	Specifies mirror destination port; the no command deletes mirror destination source port.

2. Specify mirror source port

Command	Explanation
Global mode	
monitor session <session> source {interface <interface-list> cpu [slot	Specifies mirror source port or VLAN; the no command deletes mirror source port or VLAN.

<pre><slotnum>] vlan <vlanid> {rx tx both} no monitor session <session> source {interface <interface-list> cpu [slot <slotnum>] vlan <vlanid> <rx tx both>}</pre>	
---	--

3. Specify flow mirror source

Command	Explanation
Global mode	
<pre>monitor session <session> source {interface <interface-list>} access-group <num> {rx tx both} no monitor session <session> source {interface <interface-list>} access-group <num></pre>	Specifies flow mirror source port and apply rule; the no command deletes flow mirror source port.

9.5.3 Mirror Examples

👉 Example:

The requirement of the configurations is shown as below: to monitor at interface 1/0/1 the data frames sent out by interface 1/0/9 and received from interface 1/0/7, At the same time, it is necessary to monitor the data frames received and sent by the CPU, and the data frames received by interface 1/0/15 and matched by rule 120 (The source IP address is 1.2.3.4 and the destination IP address is 5.6.7.8), and monitor the data frames of VLAN100-110 on ports 2 and 3, and achieve this goal by configuring mirroring.

Configuration guidelines:

1. Configure interface 1/0/1 to be a mirror destination interface.
2. Configure the interface 1/0/7 ingress and interface 1/0/9 egress to be mirrored source.
3. Configure CPU as the image source;
4. Configure access list 120.
5. Configure access 120 to binding interface 15 ingress.

Configuration procedure is as follows:

```
Switch(config)#monitor session 4 destination interface ethernet 1/0/1
Switch(config)#monitor session 4 source interface ethernet 1/0/7 rx
Switch(config)#monitor session 4 source interface ethernet 1/0/9 tx
Switch(config)#monitor session 1 source cpu
Switch(config)#access-list 120 permit tcp 1.2.3.4 0.0.0.255 5.6.7.8 0.0.0.255
Switch(config)#monitor session 4 source interface ethernet 1/0/15 access-list 120 rx
```

```
Switch(config)#monitor session 5 destination interface ethernet 1/0/2-3
```

```
Switch(config)#monitor session 5 source vlan 100-110 both
```

9.5.4 Device Mirror Troubleshooting

If problems occur on configuring port mirroring, please check the following first for causes:

- ☞ Whether the mirror destination port is a member of a TRUNK group or not, if yes, modify the TRUNK group.
- ☞ If the throughput of mirror destination port is smaller than the total throughput of mirror source port(s), the destination port will not be able to duplicate all source port traffic; please decrease the number of source ports, duplicate traffic for one direction only or choose a port with greater throughput as the destination port. Mirror destination port can not be pulled into Isolate vlan, or will affect mirror between VLAN.

☞

9.6 RSPAN

9.6.1 Introduction to RSPAN

Port mirroring refers to the duplication of data frames sent/received on a port to another port. The duplicated port is referred to as mirror source port and the duplicating port is referred to as mirror destination port. It is more convenience for network administrator to monitor and manage the network and diagnostic after the mirroring function achieved. But it only used for such instance that the mirror source port and the mirror destination ports are located in the same switch.

RSPAN (remote switched port analyzer) refers to remote port mirroring. It eliminates the limitation that the source port and the destination port must be located on the same switch. This feature makes it possible for the source port and the destination port to be located on different devices in the network, and facilitates the network administrator to manage remote switches. It can't forward traffic flows on remote mirror VLAN.

There are three types of switches with the RSPAN enabled:

1. Source switch: The switch to which the monitored port belongs. The source switch copies the mirrored traffic flows to the Remote VLAN, and then through Layer 2 forwarding, the mirrored flows are sent to an intermediate switch or destination switch.
2. Intermediate switch: Switches between the source switch and destination switch on the network. Intermediate switch forwards mirrored flows to the next intermediate switch or the destination switch. Circumstances can occur where no intermediate switch is present, if a direct connection exists between the source and destination switches.

3. Destination switch: The switch to which the destination port for remote mirroring belongs. It forwards mirrored flows it received from the Remote VLAN to the monitoring device through the destination port.

When configuring the RSPAN mirroring of the source switch, reflector port mode or destination mirror port mode can be selected. The destination switch will redirect all the data frames in the RSPAN VLAN to the RSPAN destination port. For RSPAN mirroring, normal mode and advanced mode can be chosen, normal is introduced by default and fit the normal user. The advanced mode fit the advanced user.

1. Advanced mode: To redirect data frames in RSPAN VLAN to the RSPAN destination port, the intermediary and destination devices should support the redirection of flow.
2. Normal mode: To configure the RSPAN destination port in the RSPAN VLAN. Thus, datagrams in the RSPAN VLAN will be broadcasted to the destination port. In this mode, the destination port should be in RSPAN VLAN, and the source port should not be configured for broadcasting storm control. TRUNK ports should be configured carefully in order not to forward RSPAN datagrams to external networks. The normal mode has the benefit of easy configuration, and reduced system resources.

To be noticed: Normal mode is introduced by default. When using the normal mode, datagrams with reserved MAC addresses cannot be broadcasted.

The number of the source mirror ports is not limited, and can be one or more. Multiple source ports are not restricted to be in the same VLAN. The destination port and the source ports can be in different VLAN.

For configuration of RSPAN, a dedicated RSPAN VLAN should be configured first for carrying the RSPAN datagrams. The default VLAN, dynamic VLAN, private VLAN, multicast VLAN, and the layer 3 interface enabled VLAN cannot be configured as the RSPAN VLAN. The reflector port must belong to the RSPAN VLAN. The destination port should be connected to the Monitor and the configured as access port or the TRUNK port. The RSPAN reflector port will be working dedicatedly for mirroring, when a port is configured as a reflector port, it will discards all the existing connections to the remote peer, disable configurations related to loopback interfaces, and stop forwarding datagram. Connectivity between the source and destination switch for Remote VLAN, should be made sure by configuration.

To be noticed:

1. Layer 3 interfaces related to RSPAN VLAN should not be configured on the source, intermediate, and the destination switches, or the mirrored datagrams may be discarded.
2. For the source and intermediate switches in the RSPAN connections, the native VLAN of TRUNK port cannot be configured as the RSPAN VLAN, Otherwise the RSPAN tag will be disposed before reaching the destination switches.
3. The source port, in access or trunk mode, should not be added to RSPAN VLAN if advanced RSPAN mode is chosen.
4. When configuring the remote mirroring function, the network bandwidth should be considered in order to carry the network flow and the mirrored flow.

Keywords:

RSPAN: Remote Switched Port Analyzer.

RSPAN VLAN: Dedicated VLAN for RSPAN.

RSPAN Tag: The VLAN tag which is attached to MTP of the RSPAN datagrams.

Reflector Port: The local mirroring port between the RSPAN source and destination ports, which is not directly connected to the intermediate switches.

9.6.2 RSPAN Configuration Task List

1. Configure RSPAN VLAN
2. Configure mirror source port
3. Configure mirror destination port
4. Configure reflector port
5. Configure remote VLAN of mirror group

1. Configure RSPAN VLAN

Command	Explanation
VLAN Configuration Mode	
remote-span no remote-span	To configure the specified VLAN as RSPAN VLAN. The no command will remove the configuration of RSPAN VLAN.

2. Configure mirror source port

Command	Explanation
Global Mode	
monitor session <session> source {interface <interface-list> cpu [slot <slotnum>]} {rx tx both} no monitor session <session> source {interface <interface-list> cpu [slot <slotnum>]}	To configure mirror source port; The no command deletes the mirror source port.

3. Configure mirror destination port

Command	Explanation
Global Mode	
monitor session <session> destination interface <interface-number> no monitor session <session> destination interface <interface-number>	To configure mirror destination interface; The no command deletes the mirror destination port.

4. Configure reflector port

Command	Explanation
Global Mode	
monitor session <session> reflector-port	To configure the interface to reflector port;

<interface-number> no monitor session <session> reflector-port	The no command deletes the reflector port.
---	--

5. Configure remote VLAN of mirror group

Command	Explanation
Global Mode	
monitor session <session> remote vlan <vid> no monitor session <session> remote vlan	To configure remote VLAN of mirror group, the no command deletes the remote VLAN of mirror group.

9.6.3 Typical Examples of RSPAN

Before RSPAN is invented, network administrators had to connect their PCs directly to the switches, in order to check the statistics of the network.

However, with the help of RSPAN, the network administrators can configure and supervise the switches remotely, which brings more efficiency. The figure below shows a sample application of RSPAN.

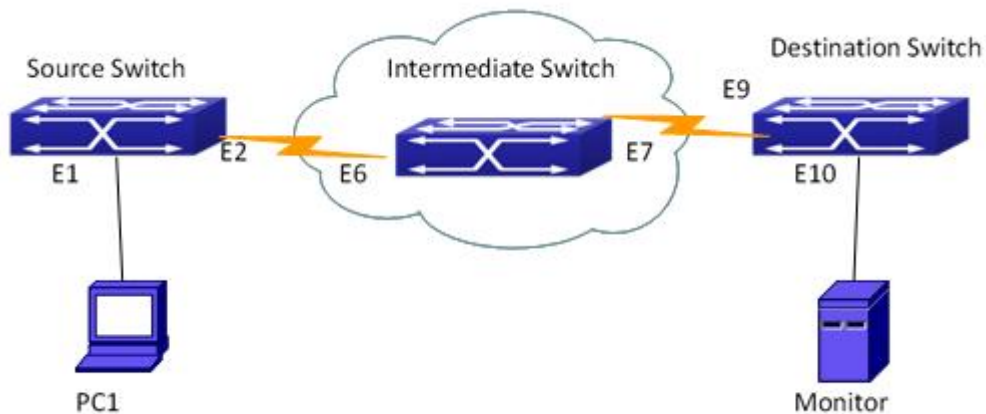

Figure 8-2 RSPAN Application Sample

Two configuration solutions can be chosen for RSPAN: the first is without reflector port, and the other is with reflector port. For the first one, only one fixed port can be connected to the intermediate switch. However, no reflector port has to be configured. This maximizes the usage of switch ports. For the latter one, the port connected to the intermediate switch is not fixed. Datagrams can be broadcasted in the RSPAN VLAN through the loopback, which is much more flexible.

The normal mode configuration is show as below:

Solution 1:

Source switch:

Interface ethernet 1/0/1 is the source port for mirroring.

Interface ethernet 1/0/2 is the destination port which is connected to the intermediate switch.

RSPAN VLAN is 5.

```
Switch(config)#vlan 5
Switch(Config-Vlan5)#remote-span
Switch(Config-Vlan5)#exit
Switch(config)#interface ethernet 1/0/2
Switch(Config-If-Ethernet1/0/2)#switchport mode trunk
Switch(Config-If-Ethernet1/0/2)#exit
Switch(config)#monitor session 1 source interface ethernet1/0/1 rx
Switch(config)#monitor session 1 destination interface ethernet1/0/2
Switch(config)#monitor session 1 remote vlan 5
```

Intermediate switch:

Interface ethernet1/0/6 is the source port which is connected to the source switch.
Interface ethernet1/0/7 is the destination port which is connected to the intermediate switch. The native VLAN of this port cannot be configured as RSPAN VLAN, or the mirrored data may not be carried by the destination switch.
RSPAN VLAN is 5.

```
Switch(config)#vlan 5
Switch(Config-Vlan5)#remote-span
Switch(Config-Vlan5)#exit
Switch(config)#interface ethernet 1/0/6-7
Switch(Config-If-Port-Range)#switchport mode trunk
Switch(Config-If-Port-Range)#exit
```

Destination switch:

Interface ethernet1/0/9 is the source port, which is connected to the source switch.
Interface ethernet1/0/10 is the destination port which is connected to the monitor. This port is required to be configured as an access port, and belong to the RSPAN VLAN.
RSPAN VLAN is 5.

```
Switch(config)#vlan 5
Switch(Config-Vlan5)#remote-span
Switch(Config-Vlan5)#exit
Switch(config)#interface ethernet 1/0/9
Switch(Config-If-Ethernet1/0/9)#switchport mode trunk
Switch(Config-If-Ethernet1/0/9)#exit
Switch(config)#interface ethernet 1/0/10
Switch(Config-If-Ethernet1/0/10)#switchport access vlan 5
Switch(Config-If-Ethernet1/0/10)#exit
```

Solution 2:

Source switch:

Interface ethernet 1/0/1 is the source port.
Interface ethernet 1/0/2 is the TRUNK port, which is connected to the intermediate switch. The

native VLAN should not be a RSPAN VLAN.

Interface Ethernet 1/0/3 is a reflector port. The reflector port belongs the RSPAN VLAN, it is access port or TRUNK port of the RSPAN VLAN.

RSPAN VLAN is 5.

```
Switch(config)#vlan 5
Switch(Config-Vlan5)#remote-span
Switch(Config-Vlan5)#exit
Switch(config)#interface ethernet1/0/2
Switch(Config-If-Ethernet1/0/2)#switchport mode trunk
Switch(Config-If-Ethernet1/0/2)#exit
Switch(config)#interface ethernet 1/0/3
Switch(Config-If-Ethernet1/0/3)#switchport mode trunk
Switch(Config-If-Ethernet1/0/3)#exit
Switch(config)#monitor session 1 source interface ethernet1/0/1 rx
Switch(config)#monitor session 1 reflector-port ethernet1/0/3
Switch(config)#monitor session 1 remote vlan 5
```

Intermediate switch:

Interface ethernet1/0/6 is the source port which is connected to the source switch.

Interface ethernet1/0/7 is the destination port which is connected to the destination switch. The native VLAN of the port should not be configured as RSPAN VLAN, or the mirrored data may not be carried by the destination switch.

RSPAN VLAN is 5.

```
Switch(config)#vlan 5
Switch(Config-Vlan5)#remote-span
Switch(Config-Vlan5)#exit
Switch(config)#interface ethernet 1/0/6-7
Switch(Config-If-Port-Range)#switchport mode trunk
Switch(Config-If-Port-Range)#exit
```

Destination switch:

Interface ethernet1/0/9 is the source port which is connected to the source switch.

Interface ethernet1/0/10 is the destination port which is connected to the monitor. This port is required to be configured as an access port, and belong to the RSPAN VLAN.

RSPAN VLAN is 5.

```
Switch(config)#vlan 5
Switch(Config-Vlan5)#remote-span
Switch(Config-Vlan5)#exit
Switch(config)#interface ethernet 1/0/9
Switch(Config-If-Ethernet1/0/9)#switchport mode trunk
Switch(Config-If-Ethernet1/0/9)#exit
```

```
Switch(config)#interface ethernet 1/0/10
Switch(Config-If-Ethernet1/0/10)#switchport access vlan 5
Switch(Config-If-Ethernet1/0/10)#exit
```

9.6.4 RSPAN Troubleshooting

Due to the following reasons, RSPAN may not function:

- 👉 Whether the destination mirror port is a member of the Port-channel group. If so, please change the Port-channel group configuration;
- 👉 The throughput the destination port is less than the total throughput of the source mirror ports. If so, the destination cannot catch all the datagrams from every source ports. To solve the problem, please reduce the number of the source ports, or mirror only single direction data flow, or choose some other port with higher capacity as the destination port.
- 👉 Between the source switch and the intermediate switch, whether the native VLAN of the TRUNK ports is configured as RSPAN VLAN. If so, please change the native VLAN for the TRUNK ports.
- 👉 After configured RSPAN, the vlan tag will be added on the packet of the egress mirror. It will cause the abort error frame on the reflection port, so the default MTU value of the switch should be modified.

9.7 ERSPAN

9.7.1 Introduction to ERSPAN

ERSPAN (Encapsulated Remote Switched Port Analyzer) eliminates the limitation that the source port and the destination port must be located on the same switch. This feature makes it possible for the source port and the destination port to be located on different devices in the network, and facilitates the network administrator to manage remote switches. Compared with the traditional RSPAN, ERSPAN configuration is simpler and it makes the monitored traffic to be transmitted in the specified tunnel.

To be noticed

1. Monitor source of ERSPAN monitor only supports port monitor, it does not support CPU monitor and flow monitor presently.
2. For the source and destination switches in the ERSPAN connections, a tunnel must be existed.
3. When configuring the remote mirror function, the network bandwidth should be considered in order to carry the network flow and the mirrored flow.

Keywords:

ERSPAN: Encapsulated Remote Switched Port Analyzer.

9.7.2 ERSPAN Configuration Task List

1. Specify mirror source port

Command	Explanation
Global Mode	
monitor session <session> source {interface <interface-list> {rx tx both}} no monitor session <session> source {interface <interface-list>}	Specify the mirror source port; the no command deletes the mirror source port.

2. Specify mirror destination tunnel

Command	Explanation
Global Mode	
monitor session <session> destination tunnel <tunnel-number> reflector-port <interface-number> no monitor session <session> destination tunnel <tunnel-number> reflector-port <interface-number>	Specify the mirror destination tunnel; the no command deletes the mirror destination tunnel.

9.7.3 Typical Examples of ERSPAN

Before ERSPAN is invented, network administrators had to connect their PCs directly to the switches, in order to check the status of the network.

However, with the help of ERSPAN, network administrators can configure and supervise the switches remotely, which brings more efficiency.

In Layer 3 network, Device A connects to the marketing department through Ethernet 1/0/1, and connects to Ethernet1/0/2 of Device B through Ethernet 1/0/2; Device C connects to the server through Ethernet 1/0/2, and connects to Ethernet 1/0/1 of Device B through Ethernet 1/0/1. Server is able to monitor the bidirectional traffic of the marketing department across a GRE tunnel by configuring remote port mirroring. The figure below shows a sample application of ERSPAN.

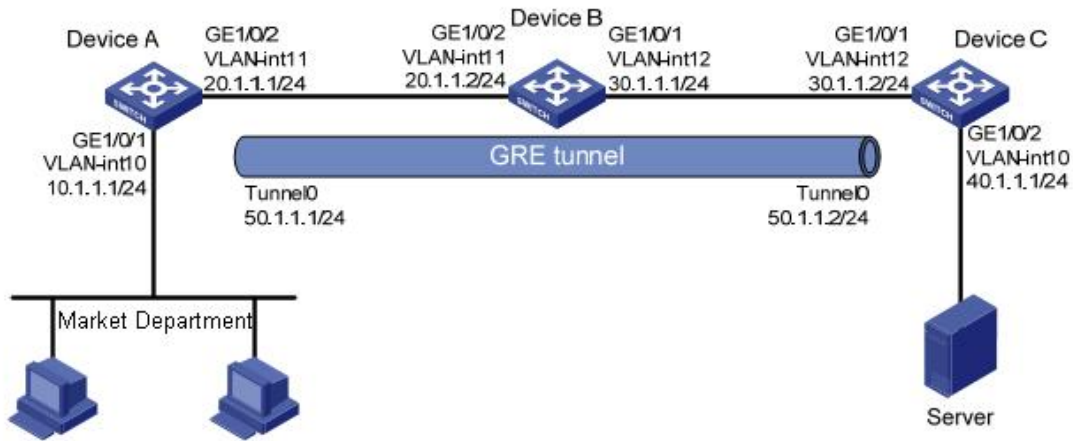

Figure 8-3 ERSPAN application diagram

Before configuring layer-3 remote port mirroring, make sure that you have created a GRE tunnel that connects the source and destination device, and ensure the normal transmitting for GRE tunnel.

The configuration of layer-3 remote port mirror needs to be processed on the source and destination devices respectively. Both the source and destination ports are configured on the source and destination devices, the difference in the following:

- 1) On Device A, configure the port which you want to monitor as the source port and configure the tunnel interface as the destination port.
- 2) On Device C, configure the physical port corresponding to the tunnel interface as the source port and configure the port that connects the data monitor device as the destination port.

(1) Configure IP addresses

Configure IP address and subnet mask for the interfaces, configuration procedures is omitted.

(2) Configure Device A (the source device)

Create interface Tunnel1, and configure an IP address and mask for it.

```
SwitchA(config)#interface tunnel 1
```

```
SwitchA(config-if-tunnel1)# tunnel mode gre ip
```

```
SwitchA (config-if-tunnel1)#ip address 50.1.1.1 255.255.255.0
```

Configure Tunnel1 to operate in GRE tunnel mode, and configure source and destination IP addresses for it.

```
SwitchA(config-if-tunnel1)# tunnel source 10.1.1.1
```

```
SwitchA(config-if-tunnel1)# tunnel destination 40.1.1.1
```

```
SwitchA(config-if-tunnel1)# exit
```

Configure OSPF protocol.

```
SwitchA (config)#router ospf
```

```
SwitchA (config-router)#network 0.0.0.0/0 area 0
```

```
SwitchA (config-router)#exit
```

Configure Ethernet 1/0/1 as a source port and Tunnel1 as the destination port of local mirroring group 1 and Ethernet1/0/3 as a reflector-port.

```
SwitchA(config)#monitor session 4 destination tunnel 1 reflector-port ethernet 1/0/3
```

```
SwitchA(config)#monitor session 4 source interface ethernet 1/0/1 both
```

(3) Configure Device B (the intermediate device)

```
# Configure OSPF protocol.
SwitchB (config)#router ospf
SwitchB (config-router)#network 0.0.0.0/0 area 0
SwitchB (config-router)#exit
(4) Configure Device C (the destination device)
# Create interface Tunnel1, and configure an IP address and mask for it.
SwitchC(config)#interface tunnel 1
SwitchC (config-if-tunnel1)# tunnel mode gre ip
SwitchC (config-if-tunnel1)#ip address 50.1.1.2 255.255.255.0
# Configure Tunnel1 to operate in GRE tunnel mode, and configure source and destination IP
addresses for it.
SwitchC (config-if-tunnel1)# tunnel source 40.1.1.1
SwitchC (config-if-tunnel1)# tunnel destination 10.1.1.1
SwitchC (config-if-tunnel1)# exit
# Configure OSPF protocol.
SwitchC (config)#router ospf
SwitchC (config-router)#network 0.0.0.0/0 area 0
SwitchC (config-router)#exit
# Configure Ethernet 1/0/1 as a source port and Ethernet 1/0/2 as the destination port of local
mirroring group 1.
SwitchC (config)#monitor session 1 destination interface ethernet 1/0/2
SwitchC (config)#monitor session 1 source interface ethernet 1/0/1 rx
```

9.7.4 ERSPAN Troubleshooting

If problems occur when configuring ERSPAN, please check whether the problem is caused by the following reasons:

- ☞ Make sure GRE tunnel configuration to ensure the normal transmission for the traffic.
- ☞ If the throughput of mirror destination port is smaller than the total throughput of mirror source port(s), the destination port will not be able to duplicate the traffic of all source port; please decrease the number of source ports, duplicate traffic for one direction only or choose a port with greater throughput as the destination port.

9.8 sFlow

9.8.1 Introduction to sFlow

The sFlow (RFC 3176) is a protocol based on standard network export and used on monitoring the network traffic information developed by the InMon Company. The monitored

switch or router sends data to the client analyzer through its main operations such as sampling and statistic, then the analyzer will analyze according to the user requirements so to monitor the network.

A sFlow monitor system includes: sFlow proxy, central data collector and sFlow analyzer. The sFlow proxy collects data from the switch using sampling technology. The sFlow collector is for formatting the sample data statistic which is to be forwarded to the sFlow analyzer which will analyze the sample data and perform corresponding measure according to the result. Our switch here acts as the proxy and central data collector in the sFlow system.

We have achieved data sampling and statistic targeting physical port.

Our data sample includes the IPv4 and IPv6 packets. Extensions of other types are not supported so far. As for non IPv4 and IPv6 packet, the unify HEADER mode will be adopted following the requirements in RFC3176, copying the head information of the packet based on analyzing the type of its protocol.

The latest sFlow protocol presented by InMon Company is the version 5. Most of the sFlow analysis software has support for version 5. The message format defined in version 5 differs slightly from that in version 4. Our implementation is already compatible with that part of the content.

9.8.2 sFlow Configuration Task List

1. Configure sFlow Collector address

Command	Explanation
Global mode and Port Mode	
sflow destination <collector-address> [<collector-port>] no sflow destination	Configure the IP address and port number of the host in which the sFlow analysis software is installed. As for the ports, if IP address is configured on the port, the port configuration will be applied, or else will be applied the global configuration. The “ no sflow destination ” command restores to the default port value and deletes the IP address.

2. Configure the sFlow proxy address

Command	Explanation
Global Mode	
sflow agent-address <collector-address> no sflow agent-address	Configure the source IP address applied by the sFlow proxy; the “no” form of the command deletes this address.

3. Configure the sFlow proxy priority

Command	Explanation
Global Mode	
sflow priority <priority-value> no sflow priority	Configure the priority when sFlow receives packet from the hardware; the “ no sflow priority ” command restores to the default

4. Configure the packet head length copied by sFlow

Command	Explanation
Port Mode	
sflow header-len <length-vlaue> no sflow header-len	Configure the length of the packet data head copied in the sFlow data sampling; the “no” form of this command restores to the default value.

5. Configure the max data head length of the sFlow packet

Command	Explanation
Port Mode	
sflow data-len <length-vlaue> no sflow data-len	Configure the max length of the data packet in sFlow; the “no” form of this command restores to the default.

6. Configure the sampling rate value

Command	Explanation
Port Mode	
sflow rate {input <input-rate> output <output-rate >} no sflow rate [input output]	Configure the sampling rate when sFlow performing hardware sampling. The “no” command deletes the rate value.

7. Configure the sFlow statistic sampling interval

Command	Explanation
Port Mode	
sflow counter-interval <interval-vlaue> no sflow counter-interval	Configure the max interval when sFlow performing statistic sampling. The “no” form of this command deletes

8. Configure the analyzer used by sFlow

Command	Explanation
Global Mode	
sflow analyzer sflowtrend no sflow analyzer sflowtrend	Configure the analyzer used by sFlow, the no command deletes the analyzer.

9. Configure the global sflow version

Command	Explanation
Global Mode	
sflow version<version> no sflow version	Configure the global sflow version. The no command recovers to be the default value. Default version is 4.

9.8.3 sFlow Examples



Figure 8-4 sFlow configuration topology

As shown in the figure, sFlow sampling is enabled on the port 1/0/1 and 1/0/2 of the switch. Assume the sFlow analysis software is installed on the PC with the address of 192.168.1.200. The address of the layer 3 interface on the SwitchA connected with PC is 192.168.1.100. A loopback interface with the address of 10.1.144.2 is configured on the SwitchA. sFlow configuration is as follows:

Configuration procedure is as follows:

```
Switch#config
Switch (config)#sflow ageng-address 10.1.144.2
Switch (config)#sflow destination 192.168.1.200
Switch (config)#sflow priority 1
Switch (config)# interface ethernet1/0/1
Switch (Config-If-Ethernet1/0/1)#sflow rate input 10000
Switch (Config-If-Ethernet1/0/1)#sflow rate output 10000
Switch (Config-If-Ethernet1/0/1)#sflow counter-interval 20
Switch (Config-If-Ethernet1/0/1)#exit
Switch (config)# interface ethernet1/0/2
Switch (Config-If-Ethernet1/0/2)#sflow rate input 20000
Switch (Config-If-Ethernet1/0/2)#sflow rate output 20000
Switch (Config-If-Ethernet1/0/2)#sflow counter-interval 40
```

9.8.4 sFlow Troubleshooting

In configuring and using sFlow, the sFlow server may fail to run properly due to physical connection failure, wrong configuration, etc. The user should ensure the following:

- ☞ Ensure the physical connection is correct
- ☞ Guarantee the address of the sFlow analyzer configured under global or port mode is accessible.
- ☞ If traffic sampling is required, the sampling rate of the interface must be configured
- ☞ If statistic sampling is required, the statistic sampling interval of the interface must be configured
- ☞ If the sFlow version is the same as the version of sFlow analysis software used
- ☞ If the examination remains unsolved, please contact with the technical service center of our company.

Chapter 10 Network Time Management Configuration

10.1 NTP

10.1.1 Introduction to NTP Function

The NTP (Network Time Protocol) synchronizes timekeeping spans WAN and LAN among distributed time servers and clients, it can get millisecond precision. The introduction of event, state, transmit function and action are defined in RFC-1305.

The purpose of using NTP is to keep consistent timekeeping among all clock-dependent devices within the network so that the devices can provide diverse applications based on the consistent time.

For a local system running NTP, its time can be synchronized by other reference sources and can be used as a reference source to synchronize other clocks, also can synchronize each other by transmit NTP packets.

10.1.2 NTP Function Configuration Task List

1. To enable NTP function
2. To configure NTP server function
3. To configure the max number of broadcast or multicast servers supported by the NTP client
4. To configure time zone
5. To configure NTP access control list
6. To configure NTP authentication
7. To specified some interface as NTP broadcast/multicast client interface
8. To configure some interface can't receive NTP packets
9. To configure the request packet sending interval of ntp client
10. Display information
11. Debug

1. To enable NTP function

Command	Explication
Global Mode	
ntp enable ntp disable	To enable or disable NTP function.

2. To configure NTP server function

Command	Explication
---------	-------------

Global Mode	
ntp server {<ip-address> <ipv6-address>} [version <version_no>] [key <key-id>] no ntp server {<ip-address> <ipv6-address>}	To enable the specified time server of time source.

3. To configure the max number of broadcast or multicast servers supported by the NTP client

Command	Explication
Global Mode	
ntp broadcast server count <number> no ntp broadcast server count	Set the max number of broadcast or multicast servers supported by the NTP client. The no operation will cancel the configuration and restore the default value.

4. To configure time zone

Command	Explication
Global Mode	
clock timezone WORD {add subtract} <0-23> [<0-59>] no clock timezone WORD	This command configures timezone in global mode, the no command deletes the configured timezone.

5. To configure NTP access control list

Command	Explication
Global Mode	
ntp access-group server <acl> no ntp access-group server <acl>	To configure NTP server access control list.

6. To configure NTP authentication

Command	Explication
Global Mode	
ntp authenticate no ntp authenticate	To enable NTP authentication function.
ntp authentication-key <key-id> md5 <value> no ntp authentication-key <key-id>	To configure authentication key for NTP authentication.
ntp trusted-key <key-id> no ntp trusted-key <key-id>	To configure trusted key.

7. To specified some interface as NTP broadcast/multicast client interface

Command	Explication
vlan Configuration Mode	

ntp broadcast client no ntp broadcast client	To configure specified interface to receive NTP broadcast packets.
ntp multicast client no ntp multicast client	To configure specified interface to receive NTP multicast packets.
ntp ipv6 multicast client no ntp ipv6 multicast client	To configure specified interface to receive IPv6 NTP multicast packets.

8. To configure some interface can't receive NTP packets

Command	Explication
vlan Configuration Mode	
ntp disable no ntp disable	To disable the NTP function.

9. To configure the request packet sending interval of ntp client

Command	Explication
Global Mode	
ntp syn-interval <1-3600> no ntp syn-interval	Configure the request packet sending interval of ntp client as 1s-3600s. The no command recovers to be the default value of 64s.

10. Display information

Command	Explication
Admin Mode	
show ntp status	To display the state of time synchronize.
show ntp session [<ip-address> <ipv6-address>]	To display the information of NTP session.

11. Debug

Command	Explication
Admin Mode	
debug ntp authentication no debug ntp authentication	To enable debug switch of NTP authentication.
debug ntp packets [send receive] no debug ntp packets [send receive]	To enable debug switch of NTP packet information.

debug ntp adjust no debug ntp adjust	To enable debug switch of time update information.
debug ntp sync no debug ntp sync	To enable debug switch of time synchronize information.
debug ntp events no debug ntp events	To enable debug switch of NTP event information.

10.1.3 Typical Examples of NTP Function

A client switch wanted to synchronize time with time server in network, there is two time server in network, the one is used as host, the other is used as standby, the connection and configuration as follows (Switch A and Switch B are the switch or route which support NTP server):

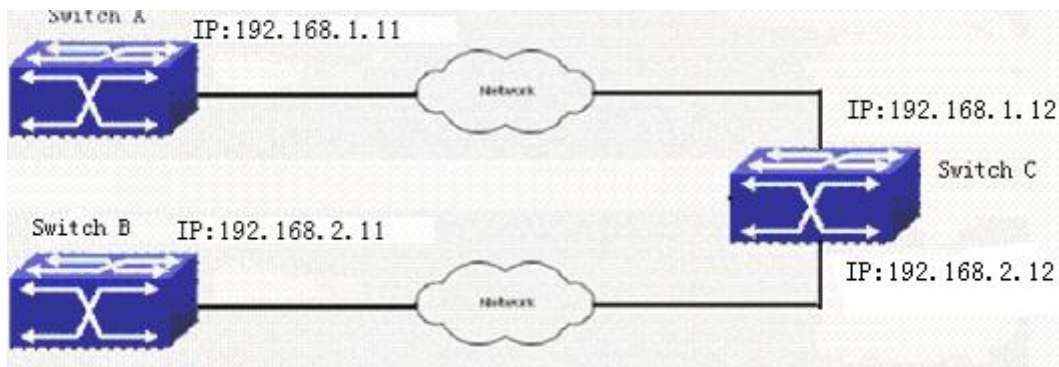

The configuration of Switch C is as follows: (Switch A and Switch B may have the different command because of different companies, we not explain there, our switches are not support NTP server at present)

Switch C:

```
Switch(config)#ntp enable
Switch(config)#interface vlan 1
Switch(Config-if-Vlan1)#ip address 192.168.1.12 255.255.255.0
Switch(config)#interface vlan 2
Switch(Config-if-Vlan1)#ip address 192.168.2.12 255.255.255.0
Switch(config)#ntp server 192.168.1.11
Switch(config)#ntp server 192.168.2.11
```

10.1.4 NTP Function Troubleshooting

In configuration procedures, if there is error occurred, the system can give out the debug

information.

The NTP function disables by default, the show command can be used to display current configuration. If the configuration is right please use debug every relative debugging command and display specific information in procedure, and the function is configured right or not, you can also use show command to display the NTP running information, any questions please send the recorded message to the technical service center.

10.2 SNTP

10.2.1 Introduction to SNTP

The Network Time Protocol (NTP) is widely used for clock synchronization for global computers connected to the Internet. NTP can assess packet sending/receiving delay in the network, and estimate the computer's clock deviation independently, so as to achieve high accuracy in network computer clocking. In most positions, NTP can provide accuracy from 1 to 50ms according to the characteristics of the synchronization source and network route.

Simple Network Time Protocol (SNTP) is the simplified version of NTP, removing the complex algorithm of NTP. SNTP is used for hosts who do not require full NTP functions; it is a subset of NTP. It is common practice to synchronize the clocks of several hosts in local area network with other NTP hosts through the Internet, and use those hosts to provide time synchronization service for other clients in LAN. The figure below depicts a NTP/SNTP application network topology, where SNTP mainly works between second level servers and various terminals since such scenarios do not require very high time accuracy, and the accuracy of SNTP (1 to 50 ms) is usually sufficient for those services.

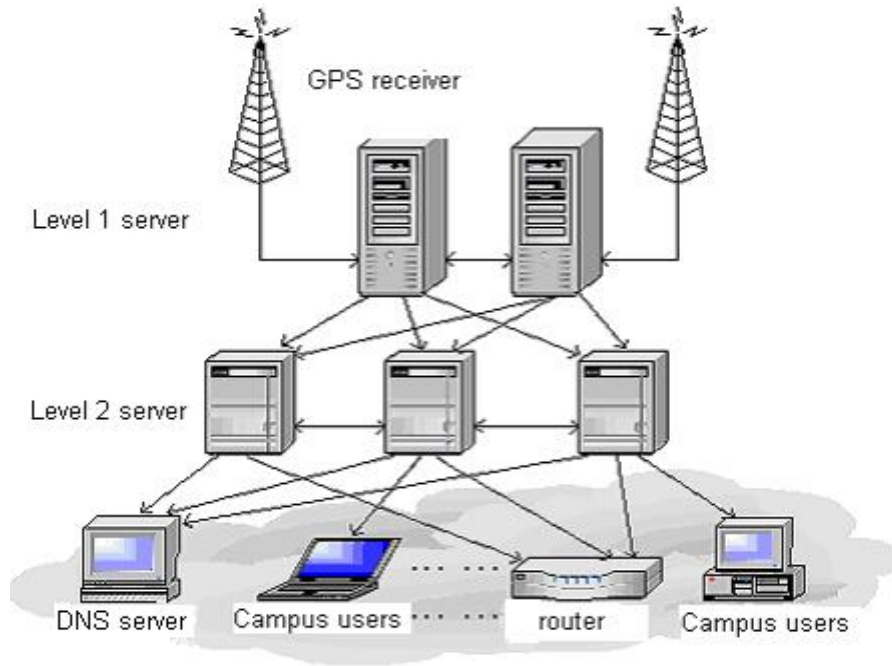

Figure 9-1 Working Scenario

Switch implements SNTPv4 and supports SNTP client unicast as described in RFC2030; SNTP client multicast and unicast are not supported, nor is the SNTP server function.

10.2.2 Typical Examples of SNTP Configuration

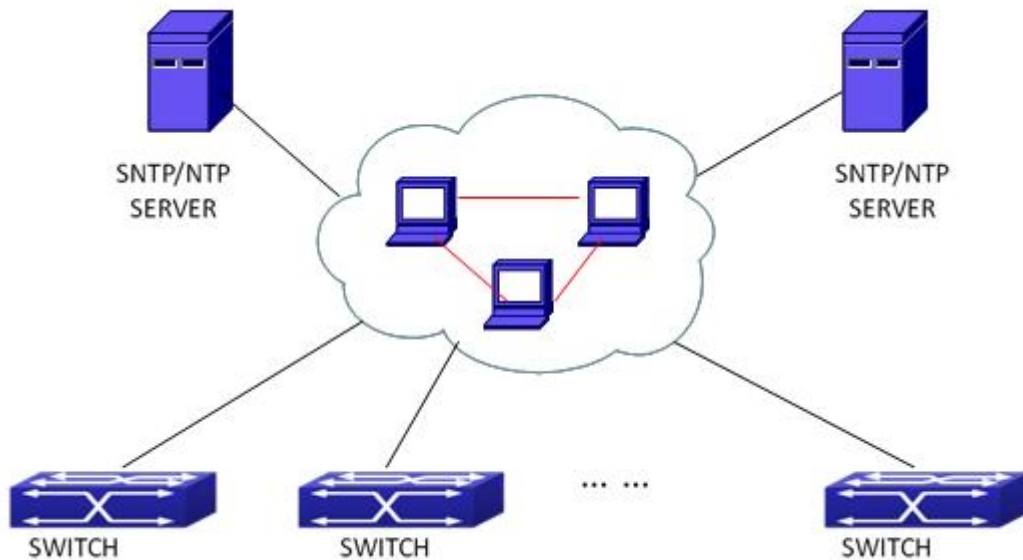

Figure 9-2 Typical SNTP Configuration

All switches in the autonomous zone are required to perform time synchronization, which is done through two redundant SNTP/NTP servers. For time to be synchronized, the network must be properly configured. There should be reachable route between any switch and the two SNTP/NTP servers.

Example: Assume the IP addresses of the SNTP/NTP servers are 10.1.1.1 and 20.1.1.1, respectively, and SNTP/NTP server function (such as NTP master) is enabled, then configurations for any switch should like the following:

```
Switch#config
```

```
Switch(config)#sntp server 10.1.1.1
```

10.3 DNSv4/v6

10.3.1 Introduction to DNS

DNS (Domain Name System) is a distributed database used by TCP/IP applications to translate domain names into corresponding IPv4/IPv6 addresses. With DNS, you can use easy-to-remember and signification domain names in some applications and let the DNS server translate them into correct IPv4/IPv6 addresses.

There are two types of DNS services, static and dynamic, which supplement each other in application. Each time the DNS server receives a name query it checks its static DNS database first before looking up the dynamic DNS database. Some frequently used addresses can be put in the static DNS database, the reduction the searching time in the dynamic DNS database would increase efficiency. The static domain name resolution means setting up mappings between domain names and IPv4/IPv6 addresses. IPv4/IPv6 addresses of the corresponding domain names can be found in the static DNS database when you use some applications. Dynamic domain name resolution is implemented by querying the DNS server. A user program sends a name query to the resolver in the DNS client when users want to use some applications with domain name, the DNS resolver looks up the local domain name cache for a match. If a match is found, it sends the corresponding IPv4/IPv6 address back to the switch. If no match is found, it sends a query to a higher DNS server. This process continues until a result, whether success or failure, is returned.

The Domain Name System (DNS) is a hierarchical naming system for computers, services, or any resource participating in the Internet. It associates various information with domain names assigned to such participants. Most importantly, it translates humanly meaningful domain names to the numerical (binary) identifiers associated with networking equipment for the purpose of locating and addressing these devices world-wide. An often used analogy to explain the Domain Name System is that it serves as the "phone book" for the Internet by translating human-friendly computer hostnames into IP addresses.

The Domain Name System makes it possible to assign domain names to groups of Internet users in a meaningful way, independent of each user's physical location. Because of this, World-Wide Web (WWW) hyperlinks and Internet contact information can remain consistent and constant even if the current Internet routing arrangements change or the participant uses a mobile device. Internet domain names are easier to remember than IP addresses such as 208.77.188.166 (IPv4) or 2001:db8:1f70::999:de8:7648:6e8 (IPv6). People take advantage of this when they recite meaningful URLs and e-mail addresses without having to know how the machine will actually locate them.

The Domain Name System distributes the responsibility for assigning domain names and

mapping them to Internet Protocol (IP) networks by designating authoritative name servers for each domain to keep track of their own changes, avoiding the need for a central register to be continually consulted and updated.

In general, the Domain Name System also stores other types of information, such as the list of mail servers that accept email for a given Internet domain. By providing a world-wide, distributed keyword-based redirection service, the Domain Name System is an essential component of the functionality of the Internet.

10.3.2 DNSv4/v6 Configuration Task List

1. To enable/disable DNS function
2. To configure/delete DNS server
3. To configure/delete domain name suffix
4. To delete the domain entry of specified address in dynamic cache
5. To enable DNS dynamic domain name resolution
6. Enable/disable DNS SERVER function
7. Configure the max number of client information in the switch queue
8. Configure the timeout value of caching the client information on the switch
9. Monitor and diagnosis of DNS function

1. To enable/disable DNS function

Command	Explanation
Global Mode	
ip domain-lookup no ip domain-lookup	To enable/disable DNS dynamic lookup function.

2. To configure/delete DNS server

Command	Explanation
Global Mode	
dns-server {<ip-address> <ipv6-address>} [priority <value>] no dns-server {<ip-address> <ipv6-address>}	To configure DNS server, the no form of this command deletes DNS server.

3. To configure/delete domain name suffix

Command	Explanation
Global Mode	
ip domain-list <WORD> no ip domain-list <WORD>	To configure/delete domain name suffix.

4. To delete the domain entry of specified address in dynamic cache

Command	Explanation

Admin Mode	
clear dynamic-host {<ip-address> <ipv6-address> all}	To delete the domain entry of specified address in dynamic cache.

5. To enable DNS dynamic domain name resolution

Command	Explanation
Global Mode	
dns lookup {ipv4 ipv6} <hostname>	To enable DNS dynamic domain name resolution.

6. Enable/disable DNS SERVER function

Command	Explanation
Global Mode	
ip dns server no ip dns server	Enable/disable DNS SERVER function.

7. Configure the max number of client information in the switch queue

Command	Explanation
Global Mode	
ip dns server queue maximum <1-5000> no ip dns server queue maximum	Configure the max number of client information in the switch queue.

8. Configure the timeout value of caching the client information on the switch

Command	Explanation
Global Mode	
ip dns server queue timeout <1-100> no ip dns server queue timeout	Configure the timeout value of caching the client information on the switch.

9. Monitor and diagnosis of DNS function

Command	Explanation
Admin Mode and Configuration Mode	
show dns name-server	To show the configured DNS server information.
show dns domain-list	To show the configured DNS domain name suffix information.
show dns hosts	To show the dynamic domain name information of resolved by switch.
show dns config	Display the configured global DNS information on the switch.
show dns client	Display the DNS Client information maintained by the switch.
debug dns {all packet [send recv] events relay}	To enable/disable DEBUG of DNS function.

<pre>no debug dns {all packet [send recv] events relay}</pre>

10.3.3 Typical Examples of DNS

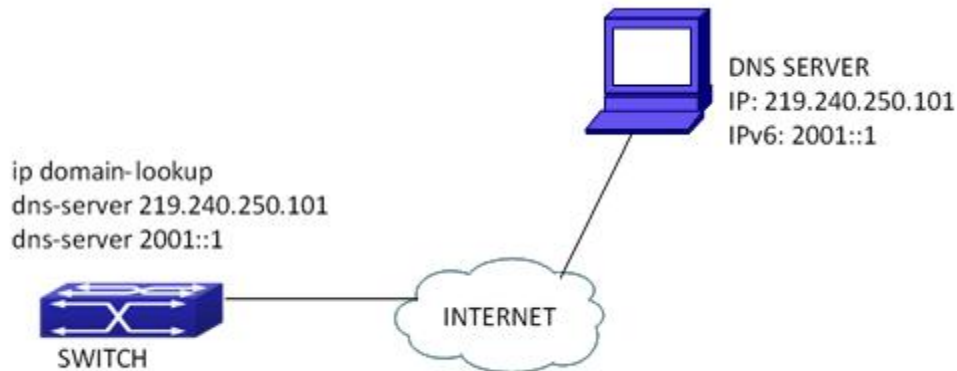

Figure 9-3 DNS CLIENT typical environment

As shown in fig, the switch connected to DNS server through network, if the switch want to visit sina Website, it needn't to know the IPv4/IPv6 address of sina Website, only need is to record the domain name of sina Website is www.sina.com.cn. The DNS server can resolute out the IPv4/IPv6 address of this domain name and send to switch, then the switch can visit sina Website correctly. The switch is configured as DNS client, basic configurations are as below: first to enable DNS dynamic domain name resolution function on switch, and configure DNS server address, then with some kinds of tools such as PING, the switch can get corresponding IPv4/IPv6 address with dynamic domain name resolution function.

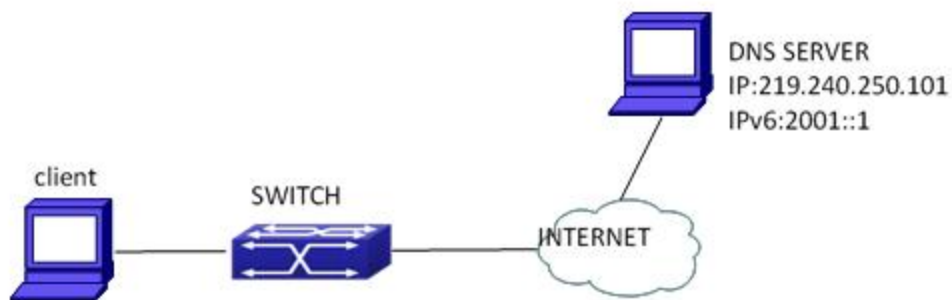

Figure 9-4 DNS SERVER typical environment

The figure above is an application of DNS SERVER. Under some circumstances, the client PC doesn't know the real DNS SERVER, and points to the switch instead. The switch plays the role of a DNS SERVER in two steps: Enable the global DNS SERVER function, configure the IP address of the real DNS server. After the DNS SERVER function is globally enabled, the switch will look up its local cache when receiving a DNS request from a client PC. If there is a domain needed by the local client, it will directly answer the client's request; otherwise, the switch will relay the request to the real DNS server, pass the reply from the DNS Server to the client and record the domain and its IP address for a faster lookup in the future.

Switch configuration for DNS CLIENT:

```
Switch(config)# ip domain-lookup
Switch(config)# dns-server 219.240.250.101
Switch(config)# dns-server 2001::1
Switch#ping host www.sina.com.cn
Switch#traceroute host www.sina.com.cn
Switch#telnet host www.sina.com.cn
```

Switch configuration for DNS SERVER:

```
Switch(config)# ip domain-lookup
Switch(config)# dns-server 219.240.250.101
Switch(config)# dns-server 2001::1
Switch(config)# ip dns server
```

10.3.4 DNS Troubleshooting

In configuring and using DNS, the DNS may fail due to reasons such as physical connection failure or wrong configurations. The user should ensure the following:

- ☞ First make sure good condition of the TACACS+ server physical connection;
- ☞ Second all interface and link protocols are in the UP state (use “**show interface**” command);
- ☞ Then please make sure that the DNS dynamic lookup function is enabled (use the “ip domain-lookup” command) before enabling the DNS CLIENT function. To use DNS SERVER function, please enable it (use the “ip dns server” command);
- ☞ Finally ensure configured DNS server address (use “**dns-server**” command), and the switch can ping DNS server;
- ☞ If the DNS problems remain unsolved, please use debug DNS all and other debugging command and copy the DEBUG message within 3 minutes, send the recorded message to the technical service center of our company.

10.4 Summer Time

10.4.1 Introduction to Summer Time

Summer time is also called daylight saving time, it is a time system for saving energy sources. In summer the time is advanced 1 hour to keep early hours, reduce the lighting, so as to save electrolighting. The rule that adopt summer time is different in each country. At present, almost 110 countries implement summer time.

Compare with the standard time, usually set summer time 1 hour late, for example, when

summer time is implementing, 10:00 am of the standard time is considered 11:00 am of summer time.

10.4.2 Summer Time Configuration Task Sequence

1. Configure absolute or recurrent time range of summer time

Command	Explanation
Global Mode	
clock summer-time <i><word></i> absolute <i><HH:MM></i> <i><YYYY.MM.DD></i> <i><HH:MM></i> <i><YYYY.MM.DD></i> [<i><offset></i>] no clock summer-time	Set absolute time range of summer time, start and end summer time is configured with specified year.
clock summer-time <i><word></i> recurring <i><HH:MM></i> <i><MM.DD></i> <i><HH:MM></i> <i><MM.DD></i> [<i><offset></i>] no clock summer-time	Set recurrent time range of summer time, every year the summer time begins from the start time and end at the end time.
clock summer-time <i><word></i> recurring <i><HH:MM></i> <i><week></i> <i><day></i> <i><month></i> <i><HH:MM></i> <i><week></i> <i><day></i> <i><month></i> [<i><offset></i>] no clock summer-time	Set recurrent time range of summer time, every year the summer time begins from the start time and end at the end time.

10.4.3 Examples of Summer Time

Example1:

The configuration requirement in the following: The summer time from 23:00 on April 1th, 2012 to 00:00 on October 1th, 2012, clock offset as 1 hour, and summer time is named as 2012.

Configuration procedure is as follows:

```
Switch(config)# clock summer-time 2012 absolute 23:00 2012.4.1 00:00 2012.10.1
```

Example2:

The configuration requirement in the following: The summer time from 23:00 on the first Saturday of April to 00:00 on the last Sunday of October year after year, clock offset as 2 hours, and summer time is named as time_travel.

Configuration procedure is as follows:

```
Switch(config)#clock summer-time time_travel recurring 23:00 first sat apr 00:00 last sun oct 120
```

10.4.4 Summer Time Troubleshooting

If there is any problem happens when using summer time, please check whether the problem

is caused by the following reasons:

- ✎ Check whether command mode in global mode
- ✎ Check whether system clock is correct

Chapter 11 VSF Configuration

11.1 VSF

11.1.1 Overview

11.1.1.1 Introduction of VSF

VSF is using the VSF port to connect several servers and build up a virtual logical facility. The user can use this virtual machine to manage all the physical facilities that link up together.

Traditional district and the data center network is using the multiple layer network topology structure design as shown below in the Fig 1-1. The following are the drawbacks of this type of network:

- (1) The network and the server are complicated, thus it will cause the operation efficiency decrease and at higher cost.
- (2) No status internet conk out switch will delay the recover time of application and break out time of operation.
- (3) Low usage of resources will decrease the return of income (ROI) and increase the capital.

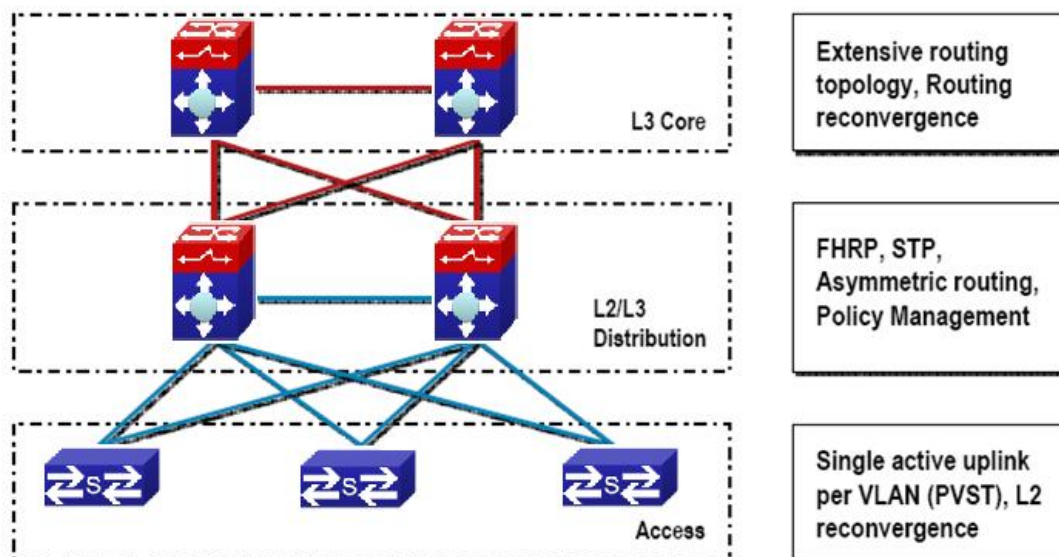

Figure 11- 1 Traditional Enterprise Network

In order to solving these problems, VSF comes. Make up more than one device which supports VSF to be the single virtualization switch. In VSF, the data panel of the management engine and the exchange array of both switches can be activated at the same time. Members of VSF can throughout the VSL to connection. The VSL standard among the members of the switches is using million-mega Ethernet for connection (maximum have 4 linkages, to provide redundancy),

likeFig 1-2.

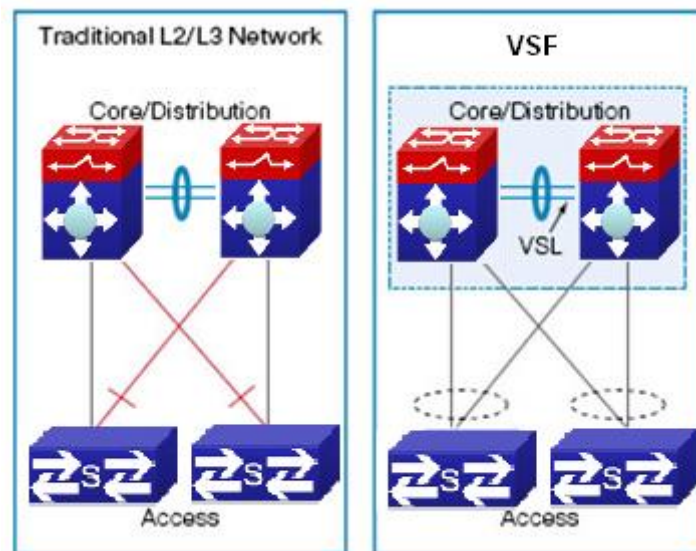

Figure 11-2 VSF

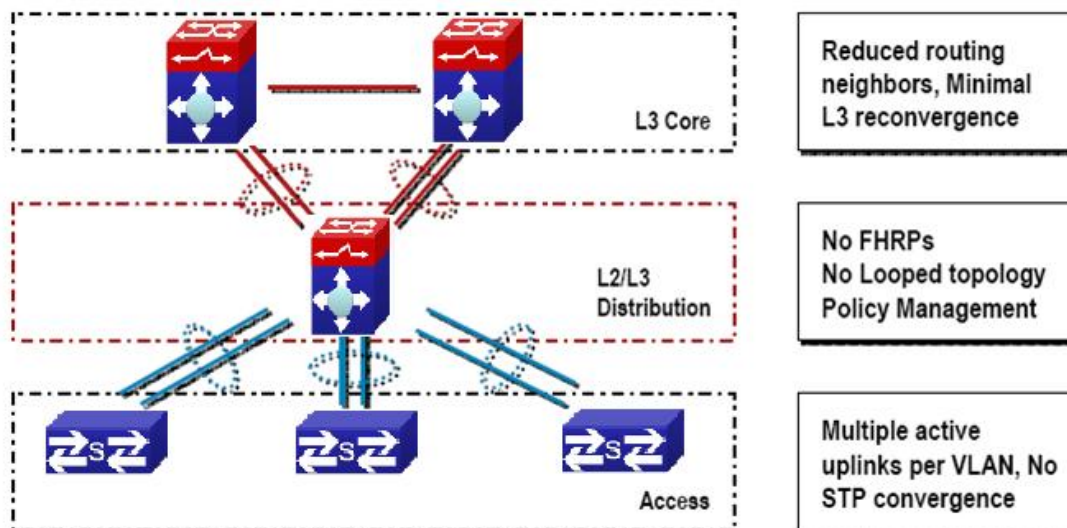

Figure 11-3 Enterprise that adopting virtual technology

Compare with the tradition L2/L3network design, VSF provides with multiple markedness advantages. All in all, we can conclude with 3 main advantages:

1. VSF can increase the efficiency of operation

Only one management point, including configuration documents and gateway IP address (dispense with HSRP/ VRRP/GLBP)

One logical device which is made up by multiple physical devices creates the simple topology without loop and without the spanning tree protocol (STP).

Bottom physical switches connect together by using standard million-mega Ethernet port; it provides a flexible deploy option for the location.

2. VSF can optimize the uninterruptedly communication

Switches status conk out switching will not interrupt the applications which are using the internet status information. With the help of VSF, if one of the virtual switch members is out of order, no need to continuous the reconstringency of L2/L3 can restart the virtual switch recover in short time. The active mode must be used for port group.

3. VSF can expand the system bandwidth capacity

In the vsf switch can activate all the L2 bandwidth, can carry on the equilibrium of load on the multiple members of VSF when expanding the bandwidth.

11.1.1.2 Basic Concept

(1) Role

Each of the facilities in the VSF is called member facility. According to the function of each member facility, will divide into 2 different roles:

Master: Responds for manage entire VSF

Standby Master: Is the standby member of VSF, as the Master backup facility for operation. When the Master is out of order, the systems will handover to Standby Master automatically to perform the original job of Master.

Slave: The member facilities that are other than Master and Standby Master in VSF.

Master, Standby Master and Slave are produced by election. For entire VSF, it can only have one Master, one Standby Master, other members should be Slave.

(2) VSF port

It is a logic port which is particular use for VSF. It divides into vsf-port1 and vsf-port2, need to colligate with the VSF physical port and then become effictive.

(3) VSF physical port

It is the facility that is used for physical connection port for VSF. VSF physical port can be VSF specific port, Ethernet port or light port (different equipment and the model will using different port, please equipt it according to the virtual situtation). Usually, Ethernet port and light port respond for transmitting operation message. After they colligate with the VSF port, they will become the VSF physical port. They will use for transmitting the message within the members. The message including VSF related negotiation message and the operation message that needs to cross over different members.

(4) Merge

Two different VSF operation separately, throughout the physical connection and configuration, it will become one VSF. This process is called merge.



Figure 11-4 Merging of VSF

(5) Split

One VSF is formed. Due to the VSF link is out of order, it will cause the facilities that are border upon cannot connect together physically. Therefore, one stracking will divide into two

stracking. This process is called split.



Figure 11-5 Splitting of tacking

(6) Priority of member

Priority of member is the member facilities attribute, mainly use for the role selection for confirming the role of each members. If the facility has higher the priority, it will have higher chance to become the Master. The default setting of the facilities is 1. If the user want to pre-set particular facility become the Master, he can increase the priority value of that facility manually before build up the VSF.

11.1.1.3 Glossary

VSF is the short form of the Virtual Switching Framework.

VSF Port: VSF port, is a mode on port-channel

VSF AM: the master card of the VSF activities

VSF SM: the backup master card of the VSF activities

VSF Slave: the slave card of VSF, to operate the VSF agreement ,during the switching it means Chassis AM, the not selecte one is VSF AM or VSF SM

VSF Member: the member facilities of VSF

VSF Master Member: the master member facility of VSF

VSF Standby Master Member: the standby master member facility of VSF

VSF Slave Member: the slave member facilities of VSF

HA: High Availability

AM: Active Master, activities controller. It is the switch whose working mode is Master is and it is in the operation status, each of the cassette vsf group can only has a AM at each time.

SM: Standby Master, the working mode in the cassette vsf group is Master and it locates in the standby status.

SSO: Stateful Switchove, the data of in-phase agreement layer will occur the switchover, the backup master agreement apply function which can connect to corresponding function fleetly. The data of this function will not be lose, but the router agreement data is not in-phase

NSF: None Stop Forwarding. Using the independent management characteristics of data layer control, data layer can still transmit data normally as the control layer is out of order

NSF/SSO: Nonstop Forwarding with Stateful Switchover means that undergo the SSO “master-backup interchange” , the data transmit is not affected

Syn process: HA synchronization processes responsible for activities control and backup agreement function collection or distribution and data synchronization communication.

GR: Graceful restart. In order to transmitting uninterruptedly, require the router confer to extend to support the GR ability.

MAD: Multi-Active Detection

11.1.1.4 VSF Typical Application

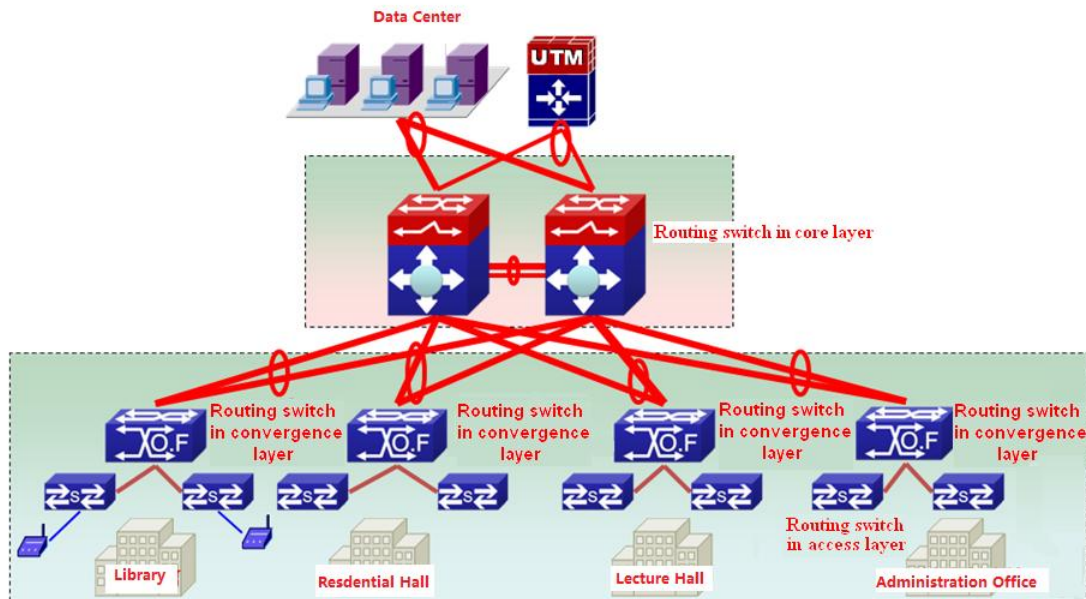

Figure 11-6 application of VSF in the campus data center

Fig 1-6 is the application of VSF in the campus internet. After using the VSF, it groups several facilities together to become the single logic facility and connect to the virtual facility. After the predigestion, the network do not need to use MSTP, VRRP protocol, it simplifies the network configuration. At the same time, it relies on the cross facilities to aggregate the link (The active mode must be used for port group). When some of the members are out of order, it will not rely on MSTP, VRRP protocol etc constringency, thus in increase the reliability.

11.1.1.5 LACP MAD

lacp mad is the dynamic aggregation method based on lacp. Each member device of vsf has one port connecting to the middle device at least.

Notice: The middle device must be the device which supports the extended function of lacp.

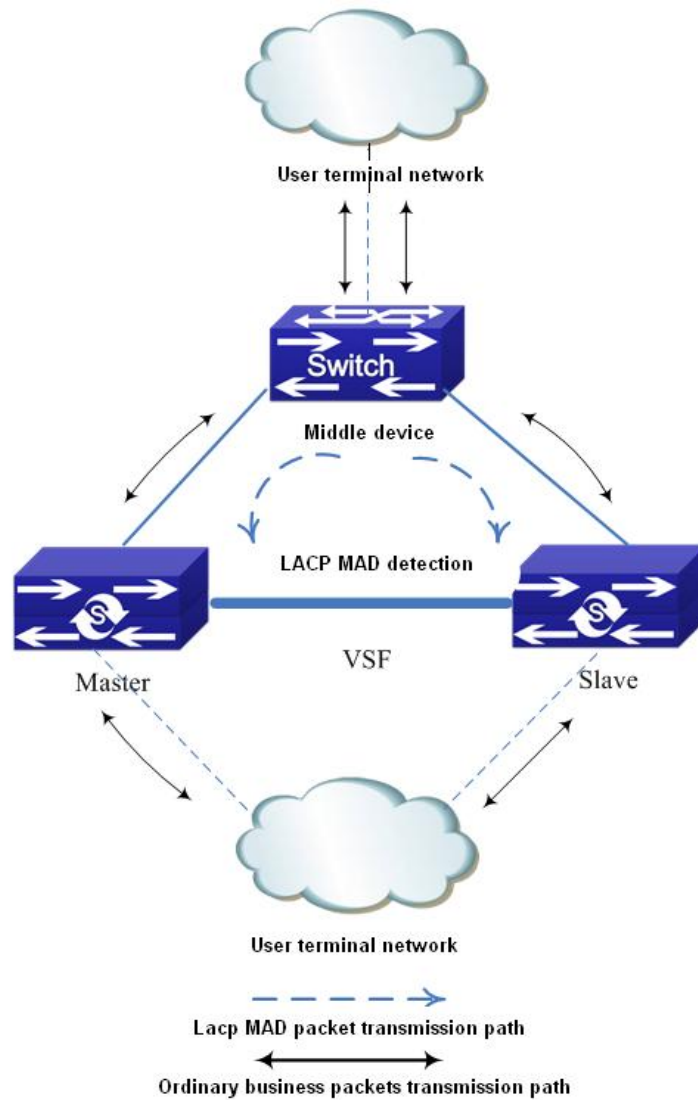

Figure 11-7 LACP MAD detection

LACP MAD detection is achieved through the extended LACP protocol packets content. It defines a new TLV (Type Length Value) in the extended field of LACP protocol packets and this TLV is used for the ActiveID of the interaction VSF. For VSF system, ActiveID value is unique, and it is expressed by the member number of the master device in VSF. After enabling LACP MAD detection, the member device interact the ActiveID information with other member devices through the LACP protocol packets.

When VSF is running normally, the ActiveID values of the LACP protocol packets sent by all member devices are the same, there is no Active conflict.

When the VSF is split into two vsf, the ActiveID values of the LACP protocol packets sent by different VSF member devices are the different and multiple Active conflict will be detected.

11.1.1.6 BFD MAD

The topology of Bfd mad detection is simpler then lacp. But, one vlan is selected for bfd mad detection once, this vlan and the ports in it will be as the specific vlan and ports of bfd mad and

they cannot be configured other functions.

Construction method: select one port on member1 and select one port on member2. Connect them with a line.

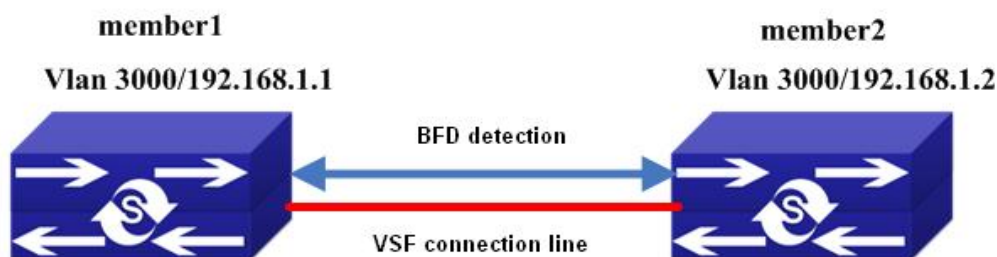

Figure 11-8 BFD MAD detection

BFD MAD detection is achieved through BFD protocol. For BFD MAD detection function running normally, enable BFD MAD detection function under the layer3 interface and configure MAD IP address on this interface. The difference between MAD IP address and the ordinary IP address is that MAD IP address is bond to the member device, each member device in VSF should configured it and they must belong to the same network segment.

When VSF is running normally, only the MAD IP address configured on master is effective, the MAD IP associated with the slave device is not effective, BFD session is under the status of down.

When the VSF is split into two vsf, the mad ip address associated with the member on the new vsf becomes effective. Through the connection line of bfd mad detection, the bfd session will be created between the two vsf to detect the multiple Active conflict.

11.1.2 Relevant VSF Configuration

11.1.2.1 VSF Configuration

VSF configuration task list:

- Configure the number of VSF members (necessary)
- Configure the priority of VSF members (optional)
- Configure the VSF domain (optional)
- Configure the logic VSF port
- Configure the logic VSF port
- Bind the physical port to the logic port
- Transform the device from independent operation mode to VSF operation mode
- Configure the VSF to merge automatically (optional)
- Describe the VSF members (optional)
- Configure the down delaying reporting function of the VSF link (optional)
- Configure the keeping time of MAC address of VSF group after VSF split (optional)
- Transform the device from VSF operation mode to the independent operation mode
- Detect the VSF link status' change quickly

Configure the number of VSF members (necessary)

Command	Explanation
Global Mode	
vsf member <member-id> no vsf member <member-id>	Configure/delete the number of VSF members.

Configure the priority and domain of VSF members (optional)

Command	Explanation
Global Mode	
vsf priority <priority> no vsf priority	Configure/delete the priority of VSF members.
vsf domain <domain-id> no vsf domain	Configure/delete the VSF domain, the no command recovers to be default of 1.

Configure the logic VSF port and Bind the physical port to the logic port

Command	Explanation
Global Mode	
vsf port-group <port-number> no vsf port-group <port-number>	Configure/delete the logic VSF port.
VSF Port Configuration Mode	
vsf port-group interface Ethernet <interface-list> no vsf port-group interface Ethernet <interface-list>	Bind the physical port to the logic VSF port or delete the binding.

Transform the operation modes of the device

Command	Explanation
Global Mode	
switch convert mode (stand-alone vsf)	Transform the device from independent operation mode to VSF operation mode or transform the device from VSF operation mode to the independent operation mode

Other configurations

Command	Explanation
Global Mode	
vsf auto-merge enable no vsf auto-merge enable	Enable the automatic merger function of VSF, the no command disables this function.
vsf member <member-id> description <text> no vsf member <member-id> description	Describe the VSF members. This information will be only written in the VSF master configuration file. The no command deletes this information.
vsf link delay<interval> no vsf link delay	Configure the down delaying reporting function of the VSF link, using for avoid link to split and

	merge due to changing in short period of time. The no command will set the time for delay report to default value.
vsf mac-address persistent <timer always> no vsf mac-address persistent	Configure VSF split group MAC address retention time. No command deletes the MAC address retention time.
vsf non-wait port-inactive no vsf non-wait port-inactive	Detect the VSF link status' change quickly for discovering the vsf splitting. The no command recovers to be the default method.

11.1.2.2 LACP MAD Configuration

LACP MAD configuration task list:

1. Create the aggregation groups
2. Add the port into the aggregation group, and one is with the active method at least
3. Configure the quick detection (optional)
4. Enable LACP MAD

1. Create the aggregation groups

Command	Explanation
Global Mode	
port-group <port-group id> no Port-group <port-group id>	Create/delete the port-group.

2. Add the port into the aggregation group

Command	Explanation
Global Mode	
interface ethernet <port-num>	Enter into the port mode.
Port Mode	
port-group <port-group id> mode <active passive> no port-group <port-group id>	Add the port into the aggregation group or let it quit.

3. Configure the quick detection

Command	Explanation
Port Mode	
lacp timeout <long short> no lacp timeout	Configure/delete the quick detection.

4. Enable LACP MAD

Command	Explanation
Aggregation Port Mode	
vsf mad lacp <enable disable>	Enable/disable LACP MAD on port-group.

11.1.2.3 BFD MAD Configuration

BFD MAD configuration task list:

1. Create the vlan used for BFD MAD
2. Add the port used for BFD MAD into the corresponding vlan
3. Configure IP address for BFD MAD layer3 interface
4. Enable BFD MAD function

1. Create the vlan used for BFD MAD

Command	Explanation
Global Mode	
vlan <vlan-id> no vlan <vlan-id>	Configure/delete vlan.

2. Add the port used for BFD MAD into the corresponding vlan

Command	Explanation
VLAN Configuration Mode	
switchport interface ethernet <port-num> no switchport interface ethernet <port-num>	Add the port into vlan or let it out.

3. Configure IP address for BFD MAD layer3 interface

Command	Explanation
Global Mode	
Interface vlan <vlan-id>	Enter into the vlan interface configuration mode.
Interface Configuration Mode	
vsf mad ip address <ip-addr> <ip-mask> member <member-id> no vsf mad ip address <ip-addr> <ip-mask> member <member-id>	Configure/delete the IP address used for BFD MAD on the layer3 interface.

4. Enable BFD MAD function

Command	Explanation
Interface Configuration Mode	
vsf mad bfd <enable disable>	Enable/disable BFD MAD.

11.1.3 Typical VSF Example

Case 1:

Configure under the independent operation mode, let two switches create VSF. The member

number of these two facilities is 1 and 2. In order to let vsf member2 as the vsf master, configure the priority of member 2 as 32, and build up two vsf port-group between both facilities. Each of the vsf port-group will colligate one of the million mega port.

switch1 VSF configuration as following:

```
switch1#config
switch1(config)#vsf member 1
switch1(config)#vsf port-group 1
switch1(config-vsf-port1)#vsf port-group interface ethernet 1/1
switch1(config)#vsf port-group 2
switch1(config-vsf-port1)#vsf port-group interface ethernet 1/2
switch1(config)#exit
switch1(config)#switch convert mode vsf
```

switch2 VSF configuration as following:

```
switch2#config
switch1(config)#vsf member 2
switch1(config)#vsf priority 32
switch1(config)#vsf port-group 1
switch1(config-vsf-port1)#vsf port-group interface ethernet 2/1
switch1(config)#vsf port-group 2
switch1(config-vsf-port1)#vsf port-group interface ethernet 2/2
switch1(config)#exit
switch1(config)#switch convert mode vsf
```

Case 2:

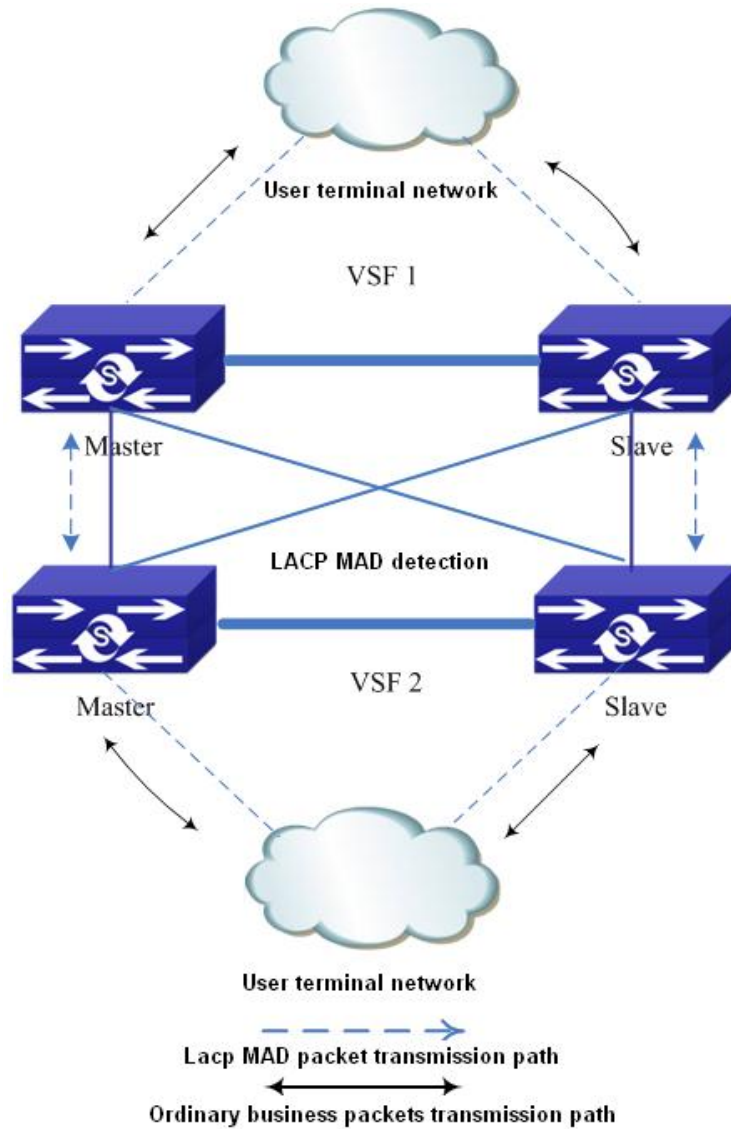

Figure 11-9 lacp mad detection topology

As shown in the above picture, use the lacp mad detection function between two vsf. Vsf1 and vsf2 are the devices which are detected and they are also the middle devices. The configuration is same with above. Proposal: uses create the overlapping connection among the devices to avoid that the vsf1 cannot be the middle device to detect vsf2 after it is split.

Assume that vsf1 and vsf2 use the lacp ports of ethernet1/1/1, ethernet 1/1/2, ethernet 2/1/1 and ethernet 2/1/2.

vsf1 configuration:

```
Switch(config)#vsf domain 1
```

Configure vsf domain number, it can be configured as other value but it cannot be the same as vsf2.

```
Switch(config)#port-group 1
```

```
Switch(config)#interface ethernet 1/1/1
```

```
Switch(config-if-ethernet1/1/1)#port-group 1 mode active
```

```

Switch(config)#interface ethernet 1/1/2
Switch(config-if-ethernet1/1/2)#port-group 1 mode active
Switch(config)#interface ethernet 2/1/1
Switch(config-if-ethernet2/1/1)#port-group 1 mode active
Switch(config)#interface ethernet 2/1/2
Switch(config-if-ethernet2/1/2)#port-group 1 mode active
Switch(config-if-ethernet2/1/2)#interface port-channel 1
Switch(config-if-port-channel1)#vsf mad lacp enable

```

vsf2 configuration:

```
Switch(config)#vsf domain 2
```

Configure vsf domain number, it can be configured as other value but it cannot be the same as vsf1.

Other configuration is same as the configuration on vsf1.

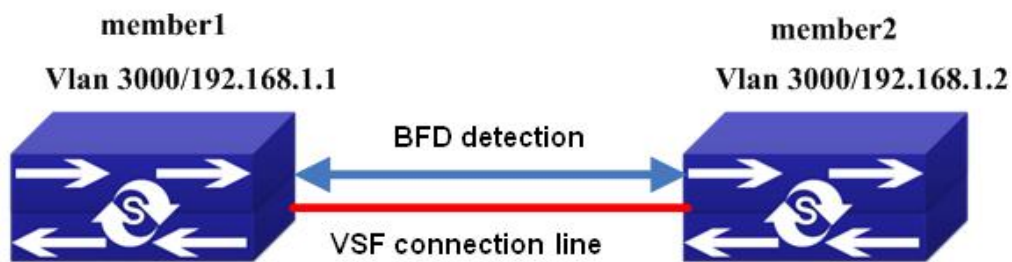
Case 3:

As show in the above picture, assume the ports used for bfd mad detection are ethernet1/1/1 and ethernet2/1/1, and the vlan is 3000. The configuration of mad ip address is the network segment of 192.168.1.1 for example.

BFD MAD configuration of switch:

```

Switch(config)#vlan 3000
Switch(config-vlan3000)#interface ethernet 1/1/1
Switch(config-if-ethernet1/1/1)#switchport access vlan 3000
Switch(config-if-ethernet1/1/1)#interface ethernet 2/1/1
Switch(config-if-ethernet2/1/1)#switchport access vlan 3000
Switch(config-if-ethernet2/1/1)#interface vlan 3000
Switch(config-if-vlan3000)#vsf mad bfd enable
Switch(config-if-vlan3000)#vsf mad ip add 192.168.1.1 255.255.255.0 member 2
Switch(config-if-vlan3000)#vsf mad ip add 192.168.1.2 255.255.255.0 member 1

```

Notice: In this time, the whole vsf is a device, so BFD MAD configuration is equivalent to conduct on one device.

11.1.4 VSF Troubleshooting

For VSF, under the configuration and usage, the command may not be workable, please pay attention to the following items:

- Whether it is at the operation mode, because some of the commands can only be configured at VSF operation mode, but some of them can operation at both VSF and independent operation mode.

Under the failure of VSF during the VSF processes, or appear any abnormality, please pay attention to the following thing:

- First, need to check whether physical connection is correct. Right now, the group VSF machine can only support million-mega port or logic port colligate. Please check whether the colligate port is the million-mega port.
- Whether the Vsf member id is clash, if the member ids are clashing, the facilities cannot form vsf.
- Whether the Vsf domain numbers are same. Only the vsf domain numbers are identical, the facilities can form the vsf.
- To see whether the logical port has any physical connection, for example, double speed, bandwidth restriction, safety authentication, ACL etc configuration.

Under the VSF operation mode to undergo configuration, please pay attention to the following things:

- During the VSF operation mode, VSF related configuration can be done on the each member separately. However, the configuration done on the members cannot be saved independently. It cans still excute the write function on the vsf master. All the membes' personal configuration that is related to vsf will be save in the main computer's vsf.cfg.
- Under the VSF operation mode, some of the commands such as VSF domain number, priority of member, member id etc can still be configured or amended. After the configuration, the show run displays as the latest value, it can only be effective as you restart the computer after saving.
- Under the VSF operation mode, the active mode must be used for port group for ensuring the fault convergence time.

For LACP MAD, under the configuration and usage, if there are problems, please pay attention to the following items:

- When creating the aggregation group, the aggregation of the device which is detected and the middle device must be identical.
- The ports of the device which is detected and the middle device cannot be added into the aggregation with on mode for LACP MAD, one should be active method at least.
- When the device which is detected and the middle device are both vsf, the domain id (vsf domain number) of the two vsf cannot be the same.

For BFD MAD, under the configuration and usage, if there are problems, please pay attention to the following items:

- ☞ bfd mad function cannot be enabled under interface vlan 1.
- ☞ bfd mad function and the anti-ring function are mutually exclusive (such as stp, mstp, etc). if this vsf is configured anti-ring function, the ports used for bfd mad detection should be disabled the anti-ring function, otherwise, the detection may fail.
- ☞ If there is port configured as trunk port on this vsf (include port-channel port), please ensure whether the vlan used for bfd mad detection is in this trunk (trunk port belongs to all vlan as default). If it is in, the vlan used for bfd mad detection must be filtered under this port, otherwise, the loop may appears.
- ☞ If there is port configured as hybrid port on this vsf, please ensure that this hybrid port does not belong the vlan used for bfd mad detection, otherwise, the loop may appears.
- ☞ The vlan interface and all the ports in this vlan used for bfd mad detection cannot be configured other configuration except bfd mad detection.
- ☞ If the bfd mad function will not be used any more, clear the configuration and the connection line used for bfd mad should be removed.
- ☞ If bfd mad configuration has been already completed, and other ports, vlan or the command under the global mode should be modified, please ensure whether it conforms the above items.
- ☞ Suggestion: user should select a vlan which is not used in business on the whole as the specific vlan for bfd mad detection.

Chapter 12 DataCenter Configuration

12.1 MC-LAG

12.1.1 Introduction to MC-LAG

MC-LAG (Multichassis Link Aggregation Group), that is, the cross device link aggregation group, is a mechanism to realize cross device link aggregation. As shown in Figure 1, two access switches conduct link aggregation negotiation with the accessed devices in the same state, so as to improve the link reliability from the board level to the device level and form a dual active system.

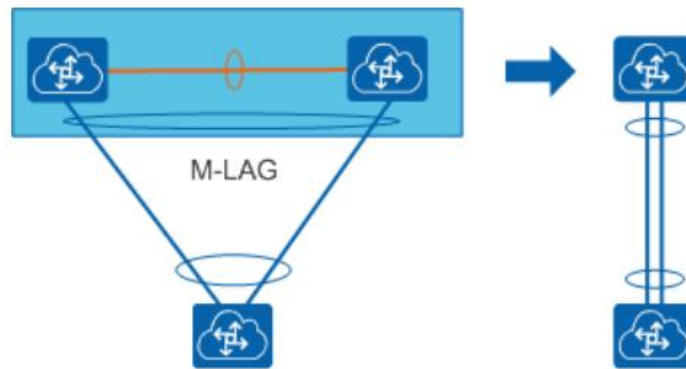

Figure 13-10 Schematic diagram of MC-LAG

MC-LAG is an extended protocol of LACP. The content of MC-LAG is not specified in 802.1ax. MC-LAG depends on various manufacturers and belongs to a private protocol. MC-LAG is compatible with LACP. Two MC-LAG switches use the same LACP protocol information externally and behave like a common switch.

12.1.2 Typical application

12.1.2.1 Dual-homing access to IP network

The server is dual-homed to the network through MC-LAG, and the gateway is on the MC-LAG device. The upstream traffic of the server is balanced to the two access devices through LACP, the downstream traffic is balanced to the two access devices through ECMP, and forwarded to the server locally.

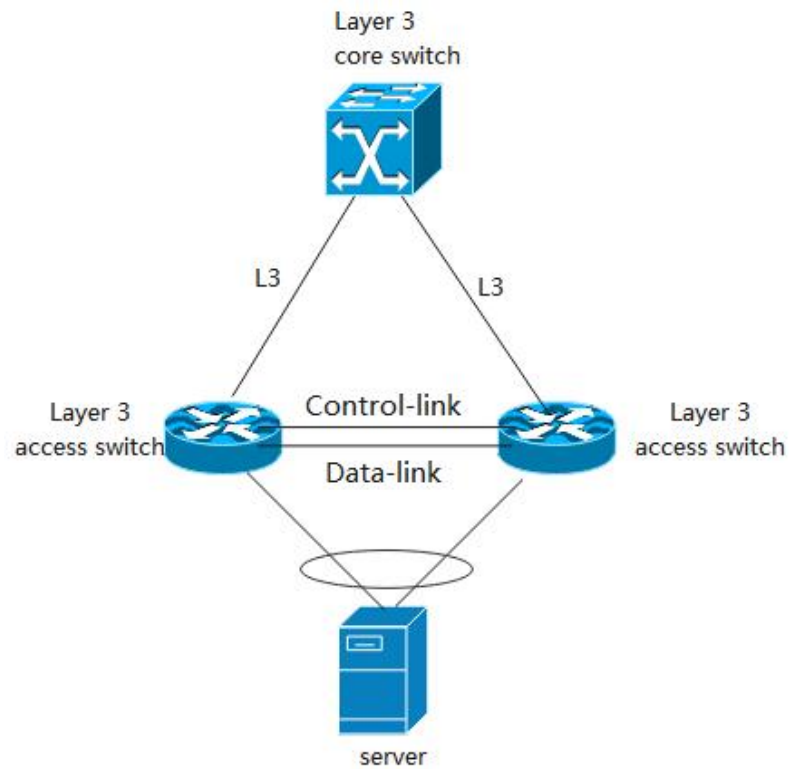

Figure 13-11 MC-LAG access to IP network

12.1.2.2 Dual-homing access to VXLAN network

The server is dual-homed to the VXLAN network through MC-LAG, and the gateway is on the core device. The upstream traffic of the server is balanced to the two access devices through LACP, and the downstream traffic is balanced to the two access devices through ECMP and forwarded to the server locally.

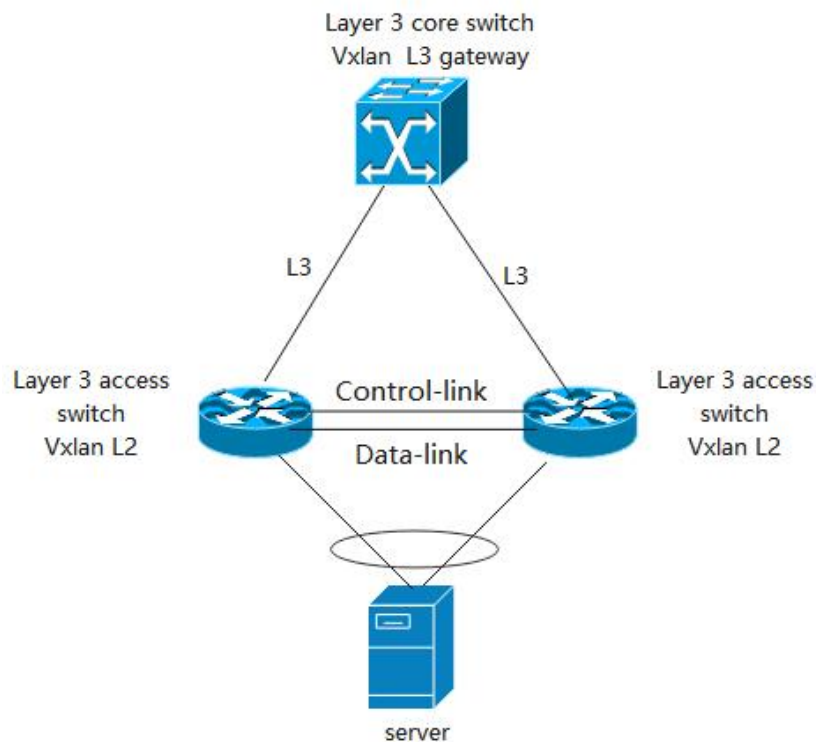

Figure 13-12 MC-LAG accesses the VXLAN network

12.1.3 MC-LAG Configuration

The MC-LAG Configuration Task List:

1. Configure mc-lag data link port
2. Configure port group to join mc-lag group
3. Configure VEG group
4. Enter mc-lag configuration mode
 - (1) Configure mc-lag domain ID (necessary)
 - (2) Configure mc-lag domain priority (optional)
 - (3) Configure the IP address of the layer 3 interface of the local mc-lag control link (necessary)
 - (4) Configure the IP address of the layer 3 interface of the peer's mc-lag control link (necessary)
 - (5) Associate VEG group with mc-lag (necessary)
 - (6) Enable mc-lag function (necessary)
5. Configure Gateway Interface
 - (1) Configure the IP and MAC addresses of the gateway interface
 - (2) Configure the gateway interface to bind the VEG group
6. Configure the MAC Address of the Distributed Gateway VTEP (Optional)

1. Configure mc-lag data link port

Command	Explanation
Port Mode, Port-channel Port Mode	
[no] switchport mclag data link	Configure the local mc-lag data link port; The no command is used to cancel the configuration of the local data link port.

2. Configure port group to join mc-lag group

Command	Explanation
Port-channel Port Mode	
[no] mclag group	Configure port group to join mc-lag group; The no command is used to configure the port group to leave the mc-lag group.

3. Configure VEG group

Command	Explanation
Global Mode	
[no] virtual-equipment-group <ID>	Configure a VEG group; the no command is used to unconfigured a VEG group.

4. Enter mc-lag configuration mode

Command	Explanation
Global Mode	
[no] mclag	Enter the mc-lag configuration mode after executing mclag; The no command deletes the configuration under mclag and exits the mc-lag configuration mode.
MC-LAG Mode	
mclag domain-id <1-128> no mclag domain-id	Configure mc-lag domain ID;The no command is used to delete the domain ID configuration.
MC-LAG Mode	
mclag priority <1-256> no mclag priority	Configure the mc-lag domain priority;The no command restores the default domain priority.
MC-LAG Mode	
mclag local-ip A.B.C.D no mclag local-ip	Configure the IP address of the layer 3 interface of the local mc-lag control link; The no command is used to cancel the configuration of the local IP address.
MC-LAG Mode	
mclag peer-ip A.B.C.D	Configure the IP address of the layer 3

no mclag peer-ip	interface of the peer's mc-lag control link; The no command is used to cancel the configuration of the peer's IP address.
MC-LAG Mode	
[no] virtual-equipment-group <ID>	Configure the VEG group to associate with mc-lag;The no command is used to disassociate the VEG group with mc-lag.
MC-LAG Mode	
[no] mclag enable	Enable mc-lag function; The no command is used to disable the mc-lag function.

5. Configure Gateway Interface

Command	Explanation
VLAN interface mode, NVI interface mode	
[no] ip address A.B.C.D A.B.C.D (secondary) [no] ipv6 address X:X::X:X/M mac-address XX-XX-XX-XX-XX-XX no mac-address	Configure the IP and MAC addresses of the gateway interface; The no command is used to delete the IP and MAC addresses of the gateway interface.
VLAN interface mode, NVI interface mode	
[no] virtual-equipment-group <ID>	Configure the gateway interface to bind the VEG group; The no command is used to unbind the gateway interface to the VEG group.

6. Configure the MAC Address of the Distributed Gateway VTEP (Optional)

Command	Explanation
Global Mode	
evpn nve mac-address FF-FF-FF-FF-FF-FF no evpn nve mac-address	Configure the MAC address of the distributed gateway VTEP; The no command is used to unconfigure the MAC address of the VTEP.

12.1.4 Typical Application of MC-LAG

12.1.4.1 Dual-homing access to IP network

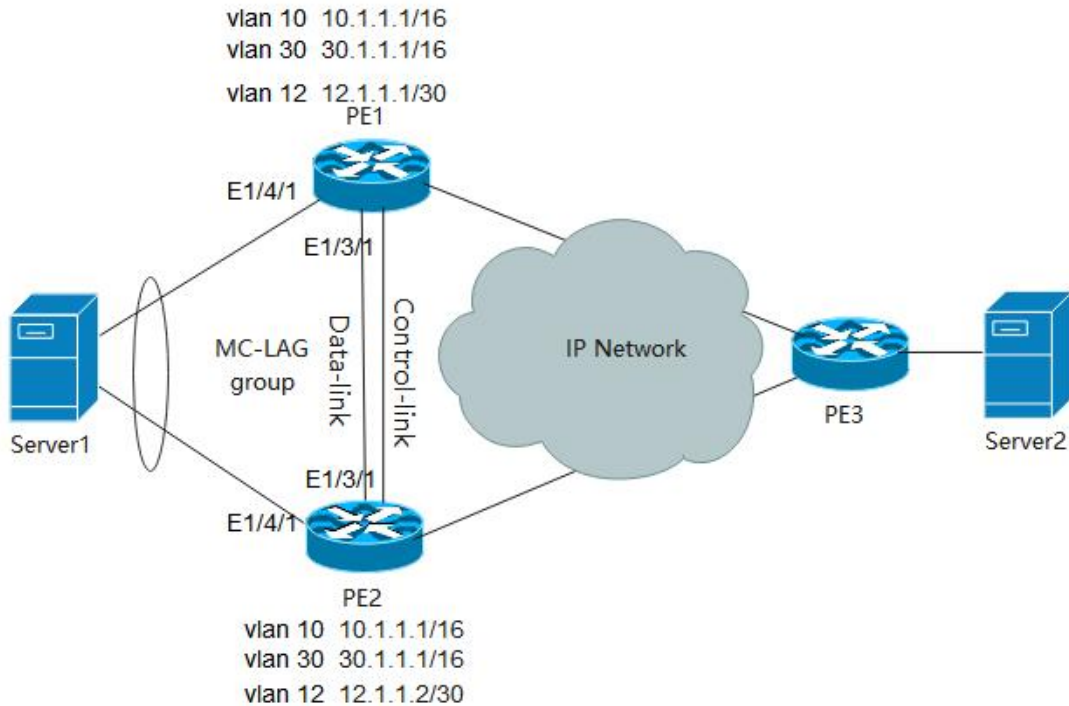

Figure 13-13 example of MC-LAG Access IP Network Configuration

As shown in Figure 2, here, taking IP network as an example, the configuration related to mc-lag is given.

PE1 Configuration:

```

#Configure VEG group
PE1(config)#virtual-equipment-group 1
#Configure mc-lag data link port
PE1(config)#interface ethernet 1/3/1
PE1(config-if-ethernet1/3/1)#switchport mode trunk
PE1(config-if-ethernet1/3/1)#switchport trunk allowed vlan 10;30
PE1(config-if-ethernet1/3/1)#switchport mclag data link
#Configure port group to join mc-lag group
PE1(config)#interface ethernet 1/4/1
PE1(config-if-ethernet1/4/1)#switchport mode trunk
PE1(config-if-ethernet1/4/1)#switchport trunk allowed vlan 10;30
PE1(config-if-ethernet1/4/1)#port-group 1 mode active
PE1(config)#interface port-channel 1
PE1(config-if-port-channel1)#mclag group
#Enter mc-lag configuration mode
PE1(config)#mclag
PE1(config-mclag)#mclag domain-id 128
PE1(config-mclag)#mclag local-ip 12.1.1.1
PE1(config-mclag)#mclag peer-ip 12.1.1.2
PE1(config-mclag)#virtual-equipment-group 1
PE1(config-mclag)#mclag enable

```

```
#Configure Gateway Interface
PE1(config)#interface vlan 10
PE1(config-if-vlan10)#ip address 10.1.1.1 255.255.0.0
PE1(config-if-vlan10)#mac-address 00-00-10-00-00-10
PE1(config-if-vlan10)#virtual-equipment-group 1
PE1(config)#interface vlan 30
PE1(config-if-vlan30)#ip address 30.1.1.1 255.255.0.0
PE1(config-if-vlan30)#mac-address 00-00-30-00-00-30
PE1(config-if-vlan30)#virtual-equipment-group 1
```

PE2 Configuration:

```
#Configure VEG group
PE1(config)#virtual-equipment-group 1
#Configure mc-lag data link port
PE2(config)#interface ethernet 1/3/1
PE2(config-if-ethernet1/3/1)#switchport mode trunk
PE2(config-if-ethernet1/3/1)#switchport trunk allowed vlan 10;30
PE2(config-if-ethernet1/3/1)#switchport mclag data link
#Configure port group to join mc-lag group
PE2(config)#interface ethernet 1/4/1
PE2(config-if-ethernet1/4/1)#switchport mode trunk
PE2(config-if-ethernet1/4/1)#switchport trunk allowed vlan 10;30
PE2(config-if-ethernet1/4/1)#port-group 1 mode active
PE2(config)#interface port-channel 1
PE2(config-if-port-channel1)#mclag group
#Enter mc-lag configuration mode
PE2(config)#mclag
PE2(config-mclag)#mclag domain-id 128
PE2(config-mclag)#mclag local-ip 12.1.1.2
PE2(config-mclag)#mclag peer-ip 12.1.1.1
PE2(config-mclag)#virtual-equipment-group 1
PE2(config-mclag)#mclag enable
#Configure Gateway Interface
PE2(config)#interface vlan 10
PE2(config-if-vlan10)#ip address 10.1.1.1 255.255.0.0
PE2(config-if-vlan10)#mac-address 00-00-10-00-00-10
PE2(config-if-vlan10)#virtual-equipment-group 1
PE2(config)#interface vlan 30
PE2(config-if-vlan30)#ip address 30.1.1.1 255.255.0.0
PE2(config-if-vlan30)#mac-address 00-00-30-00-00-30
PE2(config-if-vlan30)#virtual-equipment-group 1
```

12.1.4.2 Dual-homing access to centralized VXLAN network

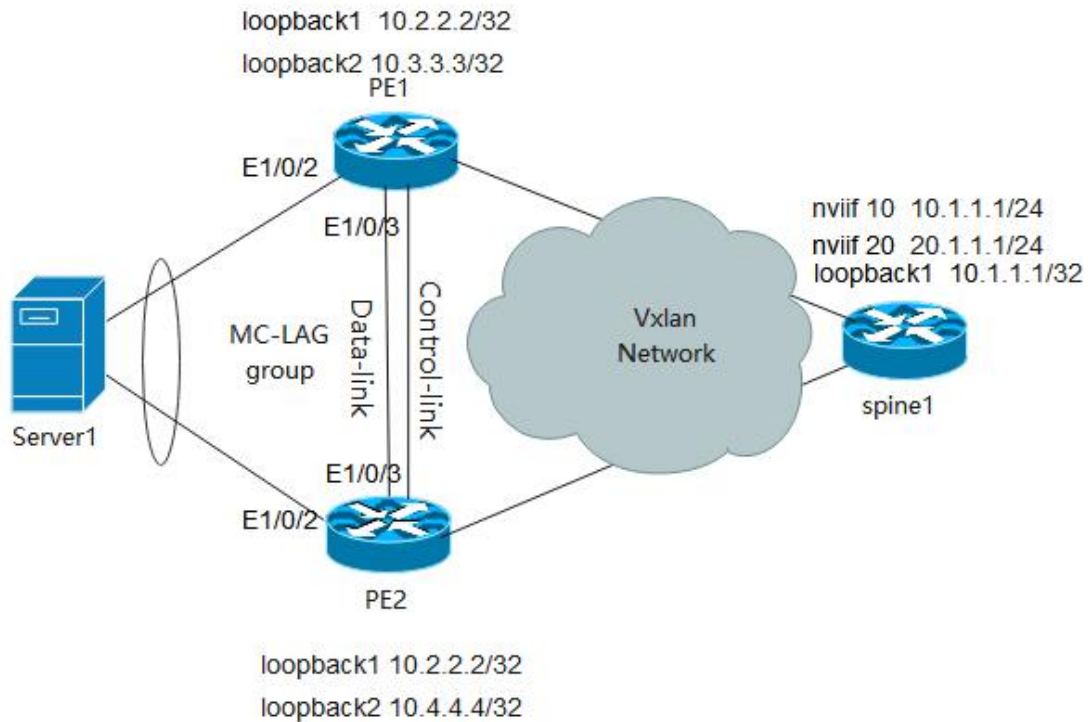

Figure 13-14 MC-LAG Access centralizedVXLAN Network Configuration

This configuration only provides the VXLAN and MC-LAG related configurations of PE1, PE2, and Spine1. The configuration of the underlay network is omitted here to ensure that the routes of each network segment of the underlay network are reachable.

PE1 Configuration:

#Configure VEG group

PE1(config)#virtual-equipment-group 1

#Configure MC-LAG domain, control link and data link, associate VEG group

PE1(config)#mclag

PE1(config-mclag)#mclag enable

PE1(config-mclag)#mclag domain id 1

PE1(config-mclag)#mclag peer ip address 10.4.4.4

PE1(config-mclag)#mclag local ip address 10.3.3.3

PE1(config-mclag)#virtual-equipment-group 1

PE1(config)#interface ethernet 1/0/3

PE1(config-if-ethernet1/0/3)#switchport mode trunk

PE1(config-if-ethernet1/0/3)#switchport mclag data link

#Configure VXLAN nvi、nve

PE1(config)#nvi 10

PE1(config-nvi)#vxlan-id 10

PE1(config)#nvi 20

PE1(config-nvi)#vxlan-id 20

PE1(config)#interface nve 1

```
PE1(config-if-nve1)#nve mode vxlan
PE1(config-if-nve1)#source 10.2.2.2
PE1(config-if-nve1)#destination 10.1.1.1
PE1(config-if-nve1)#join nvi 10
PE1(config-if-nve1)#join nvi 20
PE1(config-if-nve1)#description to-Spine
#Configure MC-LAG group and VXLAN mapping
PE1(config)#interface ethernet 1/0/2
PE1(config-if-ethernet1/0/2)#port-group 10 mode active
PE1(config)#interface port-channel 10
PE1(config-if-port-channel10)#xconnect nvi 10 mode vlan svid 10
PE1(config-if-port-channel10)#xconnect nvi 20 mode vlan svid 20
PE1(config-if-port-channel10)#mclag group
```

PE2 Configuration:

```
#Configure VEG group
PE2(config)#virtual-equipment-group 1
#Configure MC-LAG domain, control link and data link, associate VEG group
PE2(config)#mclag
PE2(config-mclag)#mclag enable
PE2(config-mclag)#mclag domain id 1
PE2(config-mclag)#mclag peer ip address 10.3.3.3
PE2(config-mclag)#mclag local ip address 10.4.4.4
PE1(config-mclag)#virtual-equipment-group 1
```

```
PE2(config)#interface ethernet 1/0/3
PE2(config-if-ethernet1/0/3)#switchport mode trunk
PE2(config-if-ethernet1/0/3)#switchport mclag data link
#Configure VXLAN nvi、nve
PE2(config)#nvi 10
PE2(config-nvi)#vxlan-id 10
PE2(config)#nvi 20
PE2(config-nvi)#vxlan-id 20
```

```
PE2(config)#interface nve 1
PE2(config-if-nve1)#nve mode vxlan
PE2(config-if-nve1)#source 10.2.2.2
PE2(config-if-nve1)#destination 10.1.1.1
PE2(config-if-nve1)#join nvi 10
PE2(config-if-nve1)#join nvi 20
PE2(config-if-nve1)#description to-Spine
#Configure MC-LAG group and VXLAN mapping
PE2(config)#interface ethernet 1/0/2
PE2(config-if-ethernet1/0/2)#port-group 10 mode active
```

```

PE2(config)#interface port-channel 10
PE2(config-if-port-channel10)#xconnect nvi 10 mode vlan svid 10
PE2(config-if-port-channel10)#xconnect nvi 20 mode vlan svid 20
PE2(config-if-port-channel10)#mclag group

```

Spine1 Configuration:

```

#Configure VXLAN nvi, nve, Gateway
Spine1(config)#nvi 10
Spine1(config-nvi)#vxlan-id 10
Spine1(config)#nvi 20
Spine1(config-nvi)#vxlan-id 20

```

```

Spine1(config)#interface nve 1
Spine1(config-if-nve1)#nve mode vxlan
Spine1(config-if-nve1)#source 10.1.1.1
Spine1(config-if-nve1)#destination 10.2.2.2
Spine1(config-if-nve1)#join nvi 10
Spine1(config-if-nve1)#join nvi 20

```

```

Spine1(config)#interface nvi-interface 10
Spine1(config-if-nvif10)#ip address 10.1.1.1 255.255.255.0
Spine1(config)#interface nvi-interface 20
Spine1(config-if-nvif20)#ip address 20.1.1.1 255.255.255.0

```

12.1.4.3 Dual-homing access to distributed VXLAN network

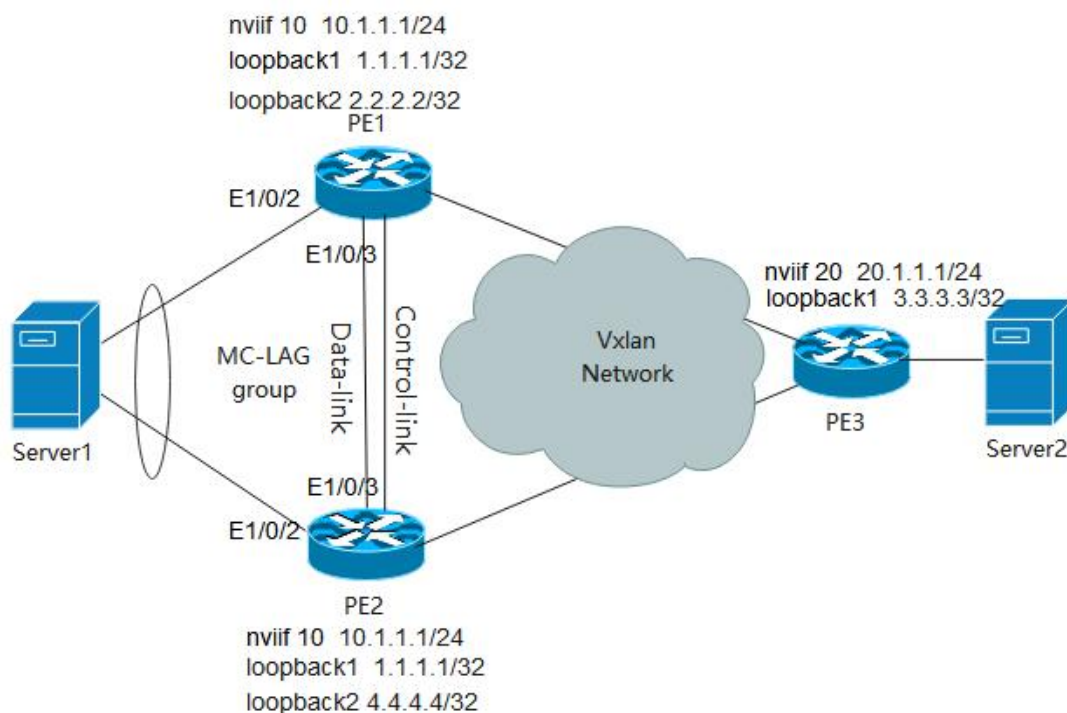

Figure 13-15 MC-LAG Access distributed VXLAN Network Configuration

Taking the VXLAN distributed gateway scenario as an example, this configuration only provides the VXLAN and MC-LAG related configurations of PE1, PE2, and PE3. The configuration of the underlay network is omitted here to ensure that the routes of each network segment of the underlay network are reachable.

PE1 Configuration:

```
#Configure VEG group
```

```
PE1(config)#virtual-equipment-group 1
```

```
#Configure MC-LAG domain, control link and data link, associate VEG group
```

```
PE1(config)#mclag
```

```
PE1(config-mclag)#mclag enable
```

```
PE1(config-mclag)#mclag domain id 1
```

```
PE1(config-mclag)#mclag peer ip address 4.4.4.4
```

```
PE1(config-mclag)#mclag local ip address 2.2.2.2
```

```
PE1(config-mclag)#virtual-equipment-group 1
```

```
PE1(config)#interface ethernet 1/0/3
```

```
PE1(config-if-ethernet1/0/3)#switchport mode trunk
```

```
PE1(config-if-ethernet1/0/3)#switchport mclag data link
```

```
#Configure VXLAN, EVPN, Gateway, VRF
```

```
PE1(config)#evpn nve source-address 1.1.1.1
```

```
PE1(config)#evpn nve mac-address 00-03-0f-22-22-22
```

```
PE1(config)#nvi 10
```

```
PE1(config-nvi)#vxlan-id 10
```

```
PE1(config-nvi)#evpn
```

```
PE1(config-nvi-evpn)#rd 1:1
```

```
PE1(config-nvi-evpn)#route-target both 100:100
```

```
PE1(config-nvi-evpn)#enable
```

```
PE1(config)#ip vrf vpn1
```

```
PE1(config-vrf)#rd 10:1
```

```
PE1(config-vrf)#route-target both 100:1
```

```
PE1(config-vrf)#l3-vni 1000
```

```
PE1(config)#interface nvi-interface 10
```

```
PE1(config-if-nvi-interface10)#ip vrf forwarding vpn1
```

```
PE1(config-if-nvi-interface10)#mac-address 00-00-33-33-99-99
```

```
PE1(config-if-nvi-interface10)#distributed-gateway enable
```

```
PE1(config-if-nvi-interface10)#ip address 10.1.1.1 255.255.255.0
```

```
PE1(config-if-nvi-interface10)#virtual-equipment-group 1
```

```
#Configure BGP
```

```
PE1(config)#router bgp 100
```

```
PE1(config-router)#neighbor 3.3.3.3 remote-as 100
```

```
PE1(config-router)#neighbor 3.3.3.3 update-source 2.2.2.2
PE1(config-router)#neighbor 4.4.4.4 remote-as 100
PE1(config-router)#neighbor 4.4.4.4 update-source 2.2.2.2
PE1(config-router)#address-family l2vpn evpn
PE1(config-router-af)#neighbor 3.3.3.3 activate
PE1(config-router-af)#neighbor 4.4.4.4 activate
PE1(config-router-af)#exit-address-family
#Configure MC-LAG group and VXLAN mapping
PE1(config)#interface ethernet 1/0/2
PE1(config-if-ethernet1/0/2)#port-group 10 mode active
PE1(config)#interface port-channel 10
PE1(config-if-port-channel10)#xconnect nvi 10 mode vlan svid 10
PE1(config-if-port-channel10)#mclag group
```

PE2 Configuration:

```
#Configure VEG group
PE2(config)#virtual-equipment-group 1
#Configure MC-LAG domain, control link and data link, associate VEG group
PE2(config)#mclag
PE2(config-mclag)#mclag enable
PE2(config-mclag)#mclag domain id 1
PE2(config-mclag)#mclag peer ip address 2.2.2.2
PE2(config-mclag)#mclag local ip address 4.4.4.4
PE2(config-mclag)#virtual-equipment-group 1
```

```
PE2(config)#interface ethernet 1/0/3
PE2(config-if-ethernet1/0/3)#switchport mode trunk
PE2(config-if-ethernet1/0/3)#switchport mclag data link
#Configure VXLAN, EVPN, Gateway, VRF
PE2(config)#evpn nve source-address 1.1.1.1
PE2(config)#evpn nve mac-address 00-03-0f-22-22-22
PE2(config)#nvi 10
PE2(config-nvi)#vxlan-id 10
PE2(config-nvi)#evpn
PE2(config-nvi-evpn)#rd 1:1
PE2(config-nvi-evpn)#route-target both 100:100
PE2(config-nvi-evpn)#enable
```

```
PE2(config)#ip vrf vpn1
PE2(config-vrf)#rd 10:1
PE2(config-vrf)#route-target both 100:1
PE2(config-vrf)#l3-vni 1000
```

```
PE2(config)#interface nvi-interface 10
```

```
PE2(config-if-nvi-interface10)#ip vrf forwarding vpn1
PE2(config-if-nvi-interface10)#mac-address 00-00-33-33-99-99
PE2(config-if-nvi-interface10)#distributed-gateway enable
PE2(config-if-nvi-interface10)#ip address 10.1.1.1 255.255.255.0
PE2(config-if-nvi-interface10)#virtual-equipment-group 1
#Configure BGP
PE2(config)#router bgp 100
PE2(config-router)#neighbor 3.3.3.3 remote-as 100
PE2(config-router)#neighbor 3.3.3.3 update-source 4.4.4.4
PE2(config-router)#neighbor 2.2.2.2 remote-as 100
PE2(config-router)#neighbor 2.2.2.2 update-source 4.4.4.4
PE2(config-router)#address-family l2vpn evpn
PE2(config-router-af)#neighbor 3.3.3.3 activate
PE2(config-router-af)#neighbor 2.2.2.2 activate
PE2(config-router-af)#exit-address-family
#Configure MC-LAG group and VXLAN mapping
PE2(config)#interface ethernet 1/0/2
PE2(config-if-ethernet1/0/2)#port-group 10 mode active
PE2(config)#interface port-channel 10
PE2(config-if-port-channel10)#xconnect nvi 10 mode vlan svid 10
PE2(config-if-port-channel10)#mclag group
```

PE3 Configuration:

```
PE3(config)#evpn nve source-address 3.3.3.3
PE3(config)#nvi 20
PE3(config-nvi)#vxlan-id 20
PE3(config-nvi)#evpn
PE3(config-nvi-evpn)#rd 2:1
PE3(config-nvi-evpn)#route-target both 100:100
PE3(config-nvi-evpn)#enable
```

```
PE3(config)#ip vrf vpn1
PE3(config-vrf)#rd 20:1
PE3(config-vrf)#route-target both 100:1
PE3(config-vrf)#l3-vni 1000
```

```
PE3(config)#interface nvi-interface 20
PE3(config-if-nvi-interface10)#ip vrf forwarding vpn1
PE3(config-if-nvi-interface10)#mac-address 00-00-33-44-99-99
PE3(config-if-nvi-interface10)#distributed-gateway enable
PE3(config-if-nvi-interface10)#ip address 20.1.1.1 255.255.255.0
```

```
#Configure BGP
PE3(config)#router bgp 100
```

```
PE3(config-router)#neighbor 4.4.4.4 remote-as 100
PE3(config-router)#neighbor 4.4.4.4 update-source 3.3.3.3
PE3(config-router)#neighbor 2.2.2.2 remote-as 100
PE3(config-router)#neighbor 2.2.2.2 update-source 3.3.3.3
PE3(config-router)#address-family l2vpn evpn
PE3(config-router-af)#neighbor 4.4.4.4 activate
PE3(config-router-af)#neighbor 2.2.2.2 activate
PE3(config-router-af)#exit-address-family
```

12.1.5 MC-LAG Troubleshooting Help

When configuring and using mc-lag, mc-lag may not operate normally due to physical connection, configuration error and other reasons. Therefore, users should pay attention to the following points:

- ☞ First of all, to ensure correct physical connection;
- ☞ Secondly, to ensure interface and link protocol are UP (execute **show interface** instruction) ;
- ☞ Then, you should ensure that all member ports in the same aggregation group have the same negotiation parameters;
- ☞ After the configuration is completed, you can execute **show mclag** instruction to view the mc-lag configuration and status information, and execute **show mclag group** instruction to view the mc-lag group configuration and status information.

12.2 NETCONF

12.2.1 Introduction to NETCONF

12.2.1.1 Brief Introduction To NETCONF

NETCONF (Network Configuration Protocol, Network Configuration Protocol) is a network configuration and management protocol based on Extensible Markup Language (XML), using a simple RPC (Remote Procedure Call)-based mechanism to implement communication between client and server.

The NETCONF protocol provides a mechanism for managing network devices. Through the NETCONF protocol, network devices can provide a set of complete and standardized APIs (Application Programming Interface), and applications can directly use these APIs to deliver and obtain configurations to network devices; users can use this mechanism to add, modify, and delete network devices to obtain the configuration and status information of network devices.

The advantages of NETCONF are as follows:

- The NETCONF protocol defines messages in XML format, and uses the RPC mechanism to modify the configuration information, which not only facilitates the management of configuration information, but also satisfies the interoperability between devices from different manufacturers;
- Reduce network failures caused by manual configuration errors;
- It can improve the efficiency of using configuration tools to upgrade system software;
- Good scalability, devices of different manufacturers can define their own protocol operations to achieve unique management functions;
- NETCONF provides security mechanisms such as authentication and authentication to ensure the security of message transmission;

12.2.1.2 NETCONF Main Elements

The main elements of the basic network architecture of NETCONF: client, server, configuration data set.

1、Client

The client can use the NETCONF protocol for system management of network devices:

- 1) Send a request to NETCONF Server to query or modify one or more specific parameter values;
- 2) Receive the alarms and events actively sent by the NETCONF Server to know the current state of the managed device.

2、Server

The server is mainly used to maintain the information data of the managed device and respond to the client's request.

- 1) After the server receives the client's request, it will parse the data, and then return a response to the client;
- 2) When the device fails or other events occur, the server uses the Notification mechanism to actively notify the client of the alarms and events of the device, and reports the current state change of the device to the client.

3、Database

NETCONF defines the existence of one or more configuration data sets and allows configuration operations on them.

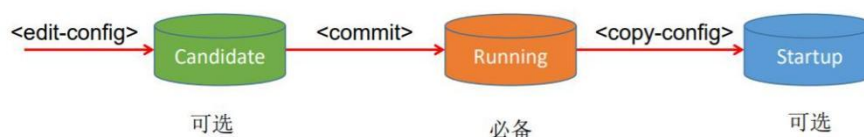

Figure 13-16

- 1) The Running database represents the configuration currently running on the device,

and this configuration database generally provides instructions for persistent operations.

2) NETCONF can support candidate, which is equivalent to an additional idle training database. You can repeatedly configure on the candidate configuration database until you get the desired result, and then use the commit operation to override the candidate configuration over the running configuration database.

3) NETCONF can also overwrite the startup configuration database with the running configuration through the copy-config command. <running/> saves the complete configuration currently active on the network device. There is only one configuration data set of this type on a device, and it always exists. Only the <running/> configuration dataset exists in the base model. Additional configuration data sets may be defined by capability sets and are only available on devices that claim to support that capability set. For example: <candidate/> Alternate configuration data set.

12.2.1.3 NETCONF Data

The NETCONF protocol distinguishes between configuration data and status data, and provides different operations to add, delete, modify, and check data.

- 1) Configuration data: data for configuring network devices;
- 2) State data (state data): data reflecting the state of the device.

NETCONF session is the logical connection between Client and Server. Netconf protocol can pass C/S session to configure and get data.

- 1) The information obtained by the Client from the running Server includes configuration data and status data.
- 2) The client can modify the configuration data, and by operating the configuration data, the state of the server can be migrated to the state expected by the user.
- 3) The Client cannot modify the status data. The status data is mainly related to the running status and statistics of the Server.

12.2.2 NETCONF Configuration

The NETCONF task configuration task sequence is as follows:

1. Enable NETCONF function
2. View the session information of NETCONF
3. View the user information connected to NETCONF

12.2.2.1 Enable NETCONF Function

Command	Explain
Global configuration mode	

netconf server enable	Enable netconf function; The no operation of this command is to disable the netconf function
no netconf server enable	

12.2.2.2 View NETCONF Session Information

Command	Explain
Privileged mode or global configuration mode	
show netconf session	View NETCONF session information

12.2.2.3 View User Information Connected To NETCONF

Command	Explain
Privileged mode or global configuration mode	
show netconf tcp	View user information connected to NETCONF

12.2.3 NETCONF For Examples

When the user wants to manage the network equipment in a unified way through the network management, and needs high security and high scalability, he or she can choose to use NETCONF to ensure the communication between the network management and the equipment.

As shown in the figure below, the network management system is deployed on the device on the client side, and the server acts as an SSH server to receive the link of the client as an SSH client, so as to manage configuration files through NETCONF. The SSH protocol is a security protocol at the application layer, which improves the reliability of NETCONF.

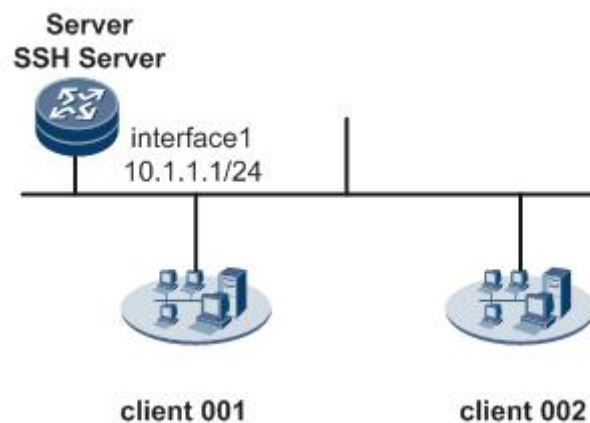

Figure 13-17

precondition: Network reachability between client and server

Steps:

- (1) Configure the username and password on the server side

```
Switch(config)# username snr privilege 15 password 0 snr123
```

- (2) Open the netconf function on server

```
Switch(config)# netconf server enable
```

- (3) Client logs in to Server through network management software

If the login is successful, the server will print Netconf: User *<user-name>* login successfully from *<user-address>*:*<user-port>*

- (4) Verify the configuration result

```
Switch(config)# show netconf tcp
```

LocalAddress	LocalPort	ForeignAddress	ForeignPort	State	IF
VRF					
0.0.0.0	830	0.0.0.0	*	LISTEN	0
0					
172.17.100.34	830	172.30.8.120	57924	ESTABLISHED	3527
0					

```
Switch(config)# Show netconf session
```

```
session_id:1
```

```
transport:netconf-ssh
```

```
username:snr
```

```
source-host:172.30.8.120
```

```
login-time:2021-07-20T15:46:40+02:00
```

```
in-rpcs:0
```

```
in-bad-rpcs:0
```

```
out-rpc-errors:0
```

```
out-notifications:0
```

- (5) Operating data through network management software

① `<get>/<get-bulk>` getting information

Client gets device vlanif information (send xml):

```
<get>
```

```
<filter type="subtree">
```

```
<snr_vlan:interface-vlans
```

```
xmlns:snr_vlan="http://nag.ru/nc/snr_vlan"/>
```

```
</filter>
```

```
</get>
```

Get results (receive XML results):

```
<?xml version="1.0" encoding="utf-8"?>
```

```
<data xmlns="urn:ietf:params:xml:ns:netconf:base:1.0">
```

```

<interface-vlans xmlns="http://nag.ru/nc/snr_vlan">
  <interface-vlan>
    <vlan-id>10</vlan-id>
    <ip-address>
      <ipv4-address>
        <address>10.1.1.1</address>
        <prefix>255.255.0.0</prefix>
      </ipv4-address>
      <ipv6-address>
        <address-str>2010:1::1/64</address-str>
      </ipv6-address>
    </ip-address>
  </interface-vlan>
  <interface-vlan>
    <vlan-id>12</vlan-id>
    <ip-address>
      <ipv4-address>
        <address>12.1.1.1</address>
        <prefix>255.255.255.0</prefix>
      </ipv4-address>
      <ipv6-address>
        <address-str>2012::1/64</address-str>
      </ipv6-address>
    </ip-address>
  </interface-vlan>
</interface-vlans>
</data>

```

② <get-config>/<get-bulk-config> get configuration information

The client obtains the device vlan information (send xml):

```

<get-config>
  <source>
    <running/>
  </source>
  <filter type="subtree">
    <snr_vlan:vlans
xmlns:snr_vlan="http://nag.ru/nc/snr_vlan"/>
  </filter>
</get-config>

```

Get results (receive XML results):

```
<?xml version="1.0" encoding="utf-8"?>
<data xmlns="urn:ietf:params:xml:ns:netconf:base:1.0">
  <vlans xmlns="http://nag.ru/nc/snr_vlan">
    <vlan>
      <vlan-id>1</vlan-id>
    </vlan>
    <vlan>
      <vlan-id>10</vlan-id>
    </vlan>
    <vlan>
      <vlan-id>12</vlan-id>
    </vlan>
  </vlans>
</data>
```

③ <edit-config> edit to add specified module data

Client adds vlan 10 (send xml):

```
<?xml version="1.0" encoding="utf-8"?>
<rpc xmlns="urn:ietf:params:xml:ns:netconf:base:1.0" message-id="">
  <edit-config>
    <target>
      <running/>
    </target>
    <config>
      <vlans xmlns="http://nag.ru/nc/snr_vlan">
        <vlan>
          <vlan-id>10</vlan-id>
        </vlan>
      </vlans>
    </config>
  </edit-config>
</rpc>
```

Return to add success (receive xml result):

```
<?xml version="1.0" encoding="utf-8"?>
<rpc-reply xmlns="urn:ietf:params:xml:ns:netconf:base:1.0"
message-id="12">
  <ok/>
```

```
</rpc-reply>
```

- ④ <edit-config> edit and delete the specified module data

Client delete vlan 10 (send xml):

```
<?xml version="1.0" encoding="utf-8"?>
<rpc xmlns="urn:ietf:params:xml:ns:netconf:base:1.0" message-id="">
  <edit-config>
    <target>
      <running/>
    </target>
    <config>
      <vlans xmlns="http://nag.ru/nc/snr_vlan">
        <vlan nc:operation="delete"
xmlns:nc="urn:ietf:params:xml:ns:netconf:base:1.0">
          <vlan-id>10</vlan-id>
        </vlan>
      </vlans>
    </config>
  </edit-config>
</rpc>
```

Return delete success (receive xml result):

```
<?xml version="1.0" encoding="utf-8"?>
<rpc-reply xmlns="urn:ietf:params:xml:ns:netconf:base:1.0" message-id="12">
  <ok/>
</rpc-reply>
```

- ⑤ <rpc> get device status

Client sends XML:

```
<?xml version="1.0" encoding="utf-8"?>
<rpc xmlns="urn:ietf:params:xml:ns:netconf:base:1.0" message-id="1">
  <snr_statis:memory-info
xmlns:snr_statis="http://nag.ru/nc/snr_statis">
    <snr_statis:get/>
  </snr_statis:memory-info>
</rpc>
```

Client receives XML result:

```
<?xml version="1.0" encoding="utf-8"?>
<rpc-reply xmlns="urn:ietf:params:xml:ns:netconf:base:1.0" message-id="8">
  <memory-usage-list xmlns="http://nag.ru/nc/snr_statis">
    <memory-usage>
      <memory-usage-member-id>1</memory-usage-member-id>
      <memory-usage-slot-id>0</memory-usage-slot-id>
      <total-memory>16384</total-memory>
```

```
<free-memory>13817556992</free-memory>
<memory-usage-percent>19.57%</memory-usage-percent>
</memory-usage>
</memory-usage-list>
</rpc-reply>
```

12.2.4 NETCONF Troubleshooting Help

- (1) When deleting a single list entry through XML, you need to delete it by adding the delete attribute to the list header. You cannot delete the list entry by deleting the key value of the current list.
- (2) When deleting a single container entry or a single list entry through XML, you do not need to add all leaf nodes in the entry, delete the container/list entry and delete the header directly to delete the current container/list. All data (deleting the list table needs to bring the key node).
- (3) When there are multiple yang files that need to interact with each other, the XML configuration needs to be delivered in order according to the order of the command line.
- (4) When configuring through xml, the device needs to be in privileged mode. If you need to configure xml in other modes, you need to configure the command multi config access on the device.

12.3 VXLAN&EVPN

VXLAN(Virtual eXtensible Local Area Network) is a technology that encapsulates Layer 2 messages with Layer 3 protocols, which can expand the Layer 2 network in the range of Layer 3. It is applied inside the data center to enable virtual machines to migrate within the interconnected Layer 3 network without changing the IP address and MAC address to ensure business continuity. VXLAN uses a 24-bit network identification, allowing users to create 16M mutually isolated virtual networks, breaking through the limitation of the current widely used VLAN that can represent 4K isolated networks, which makes large-scale multi-tenant cloud environments have enough virtual network partition resources.

Aiming at the existing problems of MPLS L2VPN, the EVPN technology formed by extending MP-BGP just complements the control layer that VXLAN lacks. The EVPN technology supporting MPLS L2VPN is defined in RFC7432, and the extension of VXLAN is defined in RFC8365.

The use of EVPN technology in the control plane has the following advantages:

- It can realize the automatic discovery of VTEP and the automatic establishment of VXLAN tunnels, thereby reducing the difficulty of network deployment and expansion.
- EVPN can publish Layer 2 MAC information and Layer 3 route information at the same time.
- It can reduce flooding traffic in the network.

12.3.1 VXLAN&EVPN Introduction

12.3.1.1 Overview of VXLAN

VXLAN has the following characteristics:

Supporting a large number of tenants: VXLAN uses a 24-bit network identifier, which greatly increases the number of supported tenants and solves the problem of insufficient VLAN resources in traditional Layer 2 networks.

Easy to maintain: VXLAN builds a large Layer 2 network based on the IP network, making network deployment and maintenance easier, and can make full use of existing IP network technologies, such as using equal-cost routing for load balancing, etc. Only the edge devices of the IP core network need to perform VXLAN processing, and the intermediate devices only need to forward packets according to the IP header, which reduces the difficulty and cost of network deployment.

Saving MAC address table entries of the switch: The access switch only learns the MAC address of the physical server, and does not need to learn the MAC address of each virtual machine, which greatly saves the MAC table space and improves the switching performance.

Currently, the device only supports VXLAN technology based on IPv4 networks, and does not support VXLAN technology based on IPv6 networks.

The typical network model of VXLAN is shown in the figure below, including the following parts:

VM(Virtual Machine): Multiple virtual machines can be created on one server, and different virtual machines can belong to different VXLANs. Virtual machines belonging to the same VXLAN are in the same logical Layer 2 network and can communicate with each other. Virtual machines belonging to different VXLANs are isolated from each other at Layer 2. VXLAN is identified by VXLAN ID, which is also known as VNI(VXLAN Network Identifier, 24 bits long).

VTEP(VXLAN Tunnel End Point): VXLAN edge device. VXLAN related processing is performed on VTEP, such as identifying the VXLAN to which the Ethernet data frame belongs, performing Layer 2 forwarding of the data frame based on VXLAN, encapsulating and decapsulating messages, and so on. The VTEP can be an independent physical device or the server where the virtual machine is located.

VXLAN Tunnel: Point-to-point logical tunnel between two VTEPs. VTEP encapsulates the VXLAN header, UDP header, and IP header for the data frame, then forwards the encapsulated message to the remote VTEP through the VXLAN tunnel, and the remote VTEP decapsulates it.

Core Equipment: Devices in the IP core network (such as the P device in the figure below). The core device does not participate in VXLAN processing, and only needs to perform Layer 3 forwarding of the message according to the destination IP address of the encapsulated message.

NVI(Network Virtual Instance): A network virtual instance on VTEP that provides Layer 2 switching services for a VXLAN network. NVI can be regarded as a virtual switch based on VXLAN for Layer 2 forwarding on VTEP. It has all the functions of traditional Ethernet switches, including source MAC address learning, MAC address aging, flooding, etc. There is a one-to-one correspondence between NVI and VXLAN.

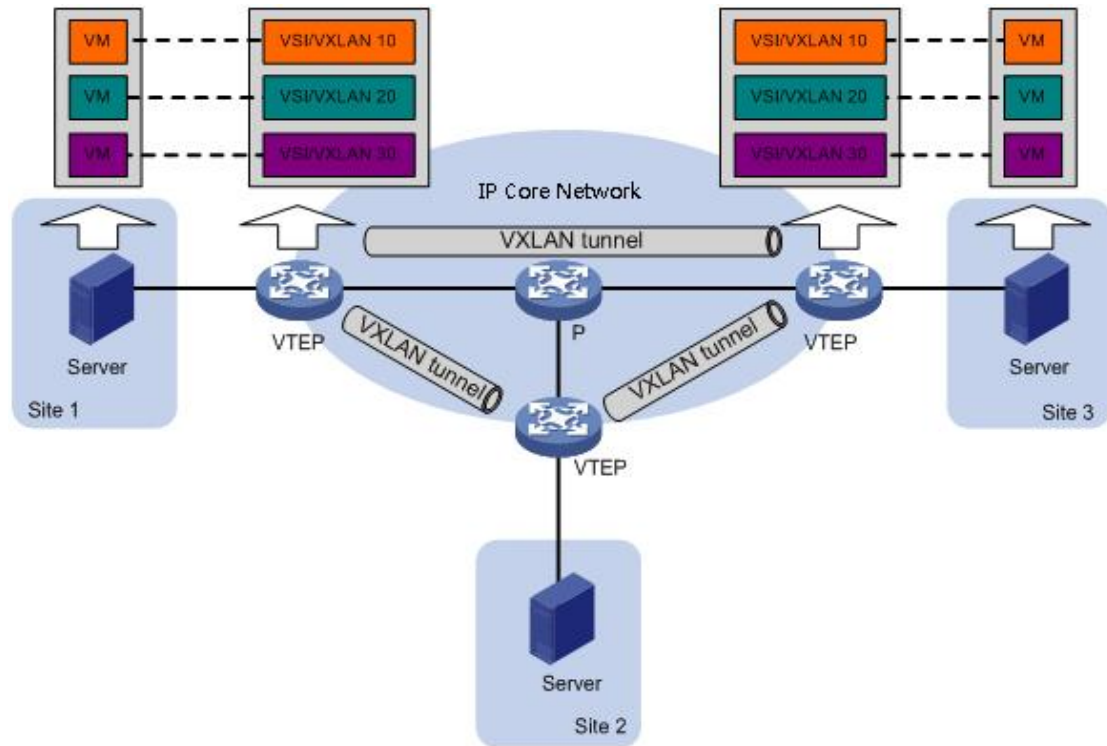

Figure 13-1 VXLAN typical network model

12.3.1.2 VXLAN Packet Encapsulation

Encapsulation format of VXLAN packet: Add 8 bytes VXLAN header, 8 bytes UDP header and 20 bytes IP header to the original layer 2 data frame. The destination port number of the UDP header is the VXLAN UDP port number (the default value is 4789).

The VXLAN header mainly includes the following two parts:

Mark bit: When the "I" bit is 1, it means that the VXLAN ID in the VXLAN header is valid; when it is 0, it means that the VXLAN ID is invalid. The other bits are reserved and set to 0.

VXLAN ID: Used to identify a VXLAN network, the length is 24 bits.

The VXLAN packet encapsulation format is shown in the figure below:

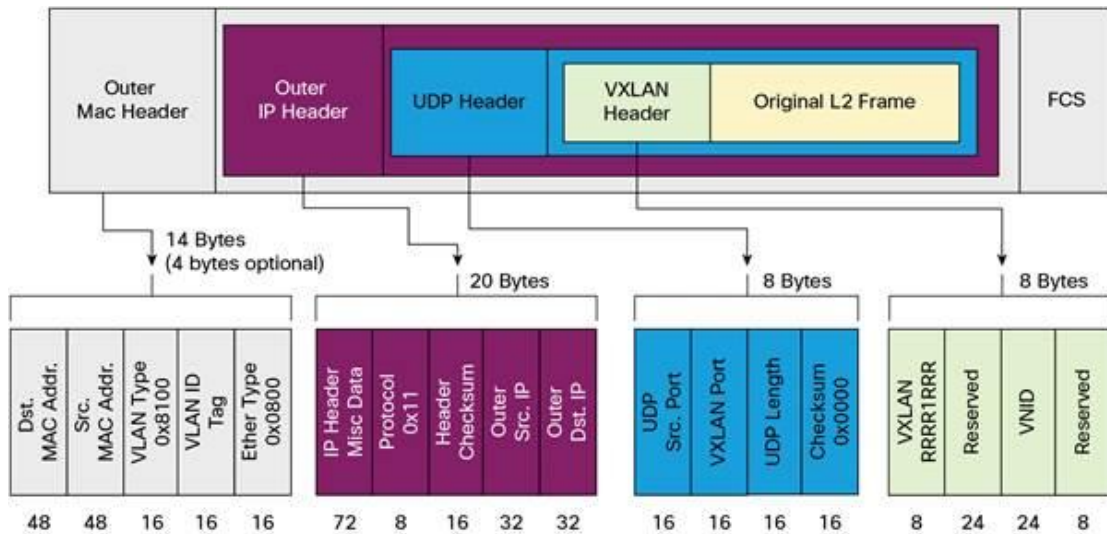

Figure 13-2 VXLAN packet encapsulation format

12.3.1.3 EVPN Introduction

EVPN(Ethernet Virtual Private Network) is a Layer 2 VPN technology, the control plane uses MP-BGP to advertise EVPN route information, and the data plane uses VXLAN or MPLS encapsulation to forward packets. When the physical sites of tenants are scattered in different locations, EVPN can provide Layer 2 interconnection for the same subnet of the same tenant based on the existing service provider or enterprise IP network.

As the control plane of VXLAN, EVPN first establishes EVPN peers between VTEPs (VXLAN Tunnel Endpoints) at both ends, and then uses EVPN routes between the peers to transfer VNI (VXLAN Network Identifier) and VTEP IP address information to each other. With this information, the VXLAN tunnel can be established.

In order to support EVPN, MP-BGP defines a new sub-address family under the L2VPN address family — EVPN address family, and adds the following EVPN NLRI (Network Layer Reachability Information), namely EVPN routes:

- (1) Ethernet Auto-discovery Route(RT-1): Used to advertise ES information in the site's multi-homing network to achieve features such as split horizon, aliasing, and active/standby backup.
- (2) MAC/IP Advertisement Route(RT-2): Used to advertise MAC/IP address information.
- (3) Inclusive Multicast Ethernet Tag Route(RT-3): Used to advertise VTEP and its VXLAN information to realize automatic discovery of VTEP, automatic establishment of VXLAN tunnels, automatic creation of VXLAN broadcast tables, etc.
- (4) Ethernet Segment Route(RT-4): Used to advertise ES and connected VTEP information, in order to discover other members of the VTEP redundancy group connected to the same ES, and to elect the designated forwarder in the VTEP redundancy group, etc.
- (5) IP Prefix Advertisement Route(RT-5): Used to advertise imported external routes in the form of IP prefixes.

Currently, the most widely used EPVN scheme is that the control plane is the MP-BGP protocol extension defined by RFC7432, and the data plane is the VXLAN encapsulation and forwarding. EVPN inherits the advantages of MP-BGP and VXLAN and has the following characteristics:

- (1) Simplified configuration: It realizes the automatic discovery of VTEP, the automatic establishment of VXLAN tunnels, and the automatic association of VXLAN tunnels and VXLANs through MP-BGP, which reduces the difficulty of network deployment without manual configuration by users.
- (2) Separate control plane and data plane: The control plane is responsible for publishing route information, and the data plane is responsible for forwarding messages, with clear division of labor and easy management.
- (3) Support multi-homing: When the same site is connected to the VXLAN network through multiple VTEPs, multiple paths connecting the site can forward traffic to improve network bandwidth utilization.
- (4) Support symmetric IRB (Integrated Routing and Bridging): MP-BGP advertises Layer 2 MAC addresses and Layer 3 route information at the same time. VTEP can perform both Layer 2 forwarding and Layer 3 routing. In this way, not only can it be ensured that the traffic is forwarded using the optimal path, but also the broadcast traffic can be reduced.

12.3.2 VXLAN&EVPN Configuration

12.3.2.1 VXLAN Configuration

VXLAN configuration task sequence:

- Configure network virtual instance globally (required)
- Configure vxlan-id in the network virtual instance view (required)
- Configure nve tunnel interface globally (required)
- Configure vxlan access mapping relationship on the access port (required)
- Show detailed information of network virtual instance and statistics of received and sent packets (optional)

Configure network virtual instance globally (required)

Command	Explanation
Global Mode	
nvi <nvi-id> no nvi <nvi-id>	Create a network virtual instance or enter the network virtual instance view; the no command deletes the network virtual instance.

Configure vxlan-id in the network virtual instance view (required)

Command	Explanation
NVI Mode	
vxlan-id <vxlan-id>	Set the ID of the VXLAN and associate it with the network virtual instance.

Configure nve tunnel interface globally (required)

Command	Explanation
Global Mode	
interface nve <nve-id> no interface nve <nve-id>	Create a vxlan tunnel interface or enter the vxlan tunnel view; the no command deletes the vxlan tunnel interface.
Nve Interface Mode	
nve mode vxlan	Configure the tunnel mode as vxlan.
source {tunnel-source-ip word} no source {tunnel-source-ip word}	Configure the ipv4 address of the source VTEP; the no command deletes the ipv4 address of the source VTEP.
destination {tunnel-destination-ip word} no destination {tunnel-destination-ip word}	Configure the ipv4 address of the destination VTEP; the no command deletes the ipv4 address of the destination VTEP.

join nvi <nvi-id> no join nvi <nvi-id>	Configure the association relationship between the network virtual instance and the vxlan tunnel; the no command cancels the association relationship between the network virtual instance and the vxlan tunnel.
description <word> no description	Configure the name of the network virtual instance or nve tunnel interface; the no command deletes the name of the network virtual instance or nve tunnel interface.

Configure vxlan access mapping relationship on the access port (required)

Command	Explanation
Port Mode	
xconnect nvi <nvi-id> {{mode {ethernet vlan svid<vid>}}} no xconnect nvi <nvi-id> {{mode {ethernet vlan svid<vid>}}}	Configure vxlan access mapping relationship on the access port; the no command deletes the vxlan access mapping relationship.

Show detailed information of network virtual instance and statistics of received and sent packets (optional)

Command	Explanation
Admin Mode	
show interface nve <nve-id>	Show the statistics of the number of sent and received packets and bytes of the nve tunnel interface.
show nvi <nvi-id> detail	Show detailed information of network virtual instance.

12.3.2.2 EVPN Configuration

EVPN configuration task sequence:

1. Configure the global NVE source address of EVPN (required)
2. Configure the delay time of the designated forwarder(DF) election (optional)
3. Configure the nvi-vlan mapping monitor of EVPN (optional)
4. Configure the automatic learning function of remote MAC/ARP/ND (optional)
5. Configure the service loopback group referenced by VXLAN (required)
6. Configure virtual equipment group (optional)
7. Configure VXLAN broadcast domain (required)
 - (1) Create a virtual switch instance (required)
 - (2) Configure the VXLAN ID of the NVI instance (required)
 - (3) Configure ARP/ND suppression (optional)
 - (4) Configure ARP/ND proxy-answer (optional)
8. Configure EVPN instance (required)

- (1) Create an EVPN instance associated with NVI (required)
- (2) Configure the route distinguisher of the EVPN instance (required)
- (3) Configure the route target of the EVPN instance (required)
- (4) Enable EVPN instance associated with NVI (required)
9. Configure service access (required)
 - (1) Configure the ESI of the port (optional)
 - (2) Configure NVI access mapping mode of the port (optional)
10. Configure L3VPN instance (optional)
 - (1) Configure the l3-vni associated with the Layer 3 VXLAN tunnel (optional)
11. Configure the gateway interface of the virtual switch instance (optional)
 - (1) Create a gateway interface for a virtual switch instance (optional)
 - (2) Configure the gateway interface to associate with the L3VPN instance (optional)
 - (3) Configure the IP and MAC addresses of the gateway interface (optional)
 - (4) Configure the gateway interface as a distributed gateway interface (optional)
 - (5) Bind the virtual equipment group (optional)
12. Configure BGP (required)
 - (1) Configure BGP neighbors (required)
 - (2) Enter EVPN address family configuration mode (required)
 - (3) Declare EVPN capability to BGP peers (required)
 - (4) Configure the route reflector client (optional)
 - (5) Exit EVPN address family configuration mode (required)
 - (6) Enter BGP VPN address family configuration mode (optional)
 - (7) Configure redistribution of routes from other sources to BGP (optional)
 - (8) Exit BGP VPN address family configuration mode (optional)

1. Configure the global NVE source address of EVPN

The NVE source address must be the local Layer 3 interface address.

Command	Explanation
Global Mode	
evpn nve source-address <ip-address> no evpn nve source-address	Configure the global NVE source address of EVPN; the no command deletes the global NVE source address of EVPN.

2. Configure the delay time of the designated forwarder(DF) election

In the multi-homing access network, the PE will start the DF election delay timer after sending the Type 4 route, and the DF election will be performed after the timer expires.

Command	Explanation
Global Mode	
evpn timer df-delay <delay-value> no evpn timer df-delay	Configure the delay time of the designated forwarder election; the no command is used to restore the default value.

3. Configure the nvi-vlan mapping monitor of EVPN

Command	Explanation
---------	-------------

Global Mode	
[no] evpn nvi-vlan-mapping-monitor disable	Disable the function of ingress vlan mapping to eti-id; the no command enables the function of ingress vlan mapping to eti-id.

4. Configure the automatic learning function of remote MAC/ARP/ND

Command	Explanation
Global Mode	
[no] vxlan remote mac-address-learning disable	Disable the automatic learning function of VXLAN remote MAC address; the no command enables the automatic learning function of VXLAN remote MAC address.
[no] vxlan remote arp-learning disable	Disable the automatic learning function of VXLAN remote ARP; the no command enables the automatic learning function of VXLAN remote ARP.
[no] vxlan remote nd-learning disable	Disable the automatic learning function of VXLAN remote ND; the no command enables the automatic learning function of VXLAN remote ND.

5. Configure virtual equipment group

Command	Explanation
Global Mode	
[no] virtual-equipment-group <1-1>	Configure the virtual equipment group; the no command deletes the virtual equipment group.
VEG Mode	
source ip A.B.C.D	Configure the local IP address of the virtual equipment group.
VEG Mode	
[no] remote ip A.B.C.D	Configure the remote IP address of the virtual equipment group; the no command deletes the remote IP address of the virtual equipment group.

6. Configure VXLAN broadcast domain

In VXLAN, VNI is used to identify a broadcast domain.

Command	Explanation
Global Mode	
[no] nvi <nvi-id>	Create a virtual switch instance; the no command deletes the virtual switch instance.
NVI Mode	

vxlan-id <vxlan-id>	Configure the VXLAN ID of the NVI instance.
NVI Mode	
[no] arp suppression enable [no] nd suppression enable	Enables ARP/ND suppression; the no command disables ARP/ND suppression.
NVI Mode	
[no] arp proxy-answer enable [no] nd proxy-answer enable	Enables ARP/ND proxy-answer; the no command disables ARP/ND proxy-answer.

7. Configure EVPN instance

Command	Explanation
NVI Mode	
[no] evpn	Create an EVPN instance associated with NVI; the no command deletes the EVPN instance associated with NVI.
EVI Mode	
rd <ASN:nn_or_IP-address:nn> no rd	Configure the route distinguisher of the EVPN instance; the no command deletes the route distinguisher of the EVPN instance.
EVI Mode	
[no] route-target {import export both} <rt-value>	Configure the route target of the EVPN instance; the no command deletes the route target of the EVPN instance.
EVI Mode	
enable disable	The enable command is used to enable the EVPN instance of NVI; the disable command is used to disable the EVPN instance of NVI.

8. Configure service access

Command	Explanation
Port Mode	
esi <esi-id> no esi	Configure the ESI of the port; the no command deletes the ESI of the port.
Port Mode	
[no] xconnect nvi <nvi-id> ((mode (ethernet (vlan svid <1-4094>))))	Configure NVI access mapping mode of the port; the no command deletes the NVI access mapping mode of the port.

9. Configure L3VPN instance

Command	Explanation
VRF Mode	
l3-vni <vxlan-id> no l3-vni	Configure the l3-vni associated with the Layer 3 VXLAN tunnel; the no command deletes the

	l3-vni associated with the Layer 3 VXLAN tunnel.
--	--

10. Configure the gateway interface of the virtual switch instance

Command	Explanation
Global Mode	
[no] interface nvi-interface <nvi-id>	Create a gateway interface for a virtual switch instance; the no command deletes the gateway interface.
NVI Interface Mode	
[no] ip vrf forwarding <vrf-name>	Configure the gateway interface to associate with the L3VPN instance; the no command deletes the association between the gateway interface and the L3VPN instance.
NVI Interface Mode	
[no] ip address A.B.C.D A.B.C.D (secondary) [no] ipv6 address X:X::X:X/M mac-address XX-XX-XX-XX-XX-XX no mac-address	Configure the IP and MAC addresses of the gateway interface; the no command deletes the IP and MAC addresses of the gateway interface.
NVI Interface Mode	
[no] distributed-gateway enable	Configure the gateway interface as a distributed gateway interface; the no command is used to restore the default centralized gateway interface.
NVI Interface Mode	
[no] virtual-equipment-group <1-1>	Bind the virtual equipment group; the no command is used to unbind the virtual equipment group.

11. Configure BGP

Command	Explanation
BGP Mode	
[no] neighbor {<ip-address> <TAG>} remote-as <as-id>	Configure BGP neighbors; the no command deletes BGP neighbors.
BGP Mode	
address-family l2vpn evpn	Enter EVPN address family configuration mode.
EVPN Address Family Mode	
[no] neighbor {<ip-address> <TAG>} activate	Exchange EVPN address family routes with BGP neighbors; the no command is used to cancel the exchange of EVPN address family routes.

EVPN Address Family Mode	
[no] neighbor {<ip-address> <TAG>} route-reflector-client	Configure the route reflector client; the no command deletes the route reflector client.
EVPN Address Family Mode	
exit-address-family	Exit EVPN address family configuration mode.
BGP Mode	
address-family ipv4 vrf <vrf-name> address-family ipv6 vrf <vrf-name>	Enter BGP VPN address family configuration mode.
BGP VPN Address Family Mode	
[no] redistribute <ROUTES> [route-map <WORD>]	Configure redistribution of routes from other sources to BGP; the no command deletes the route redistribution configuration.
BGP VPN Address Family Mode	
exit-address-family	Exit BGP VPN address family configuration mode.

12.3.3 Examples of VXLAN

12.3.3.1 Static VXLAN

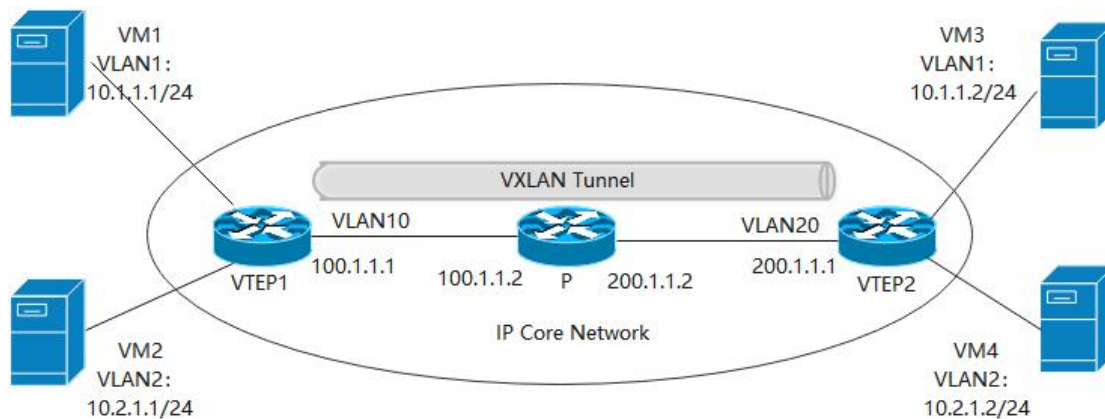

Figure 13-3 Static VXLAN networking

Configuration steps:

The specific configuration process is omitted, only the configuration process related to VXLAN is given.

(1) VTEP1 Configuration:

```
#Configure network virtual instance
VTEP1(config)#nvi 1
VTEP1(config-nvi)#vxlan-id 1
VTEP1(config-nvi)#description VM1
VTEP1(config)#nvi 2
VTEP1(config-nvi)#vxlan-id 2
```

```
VTEP1(config-nvi)#description VM2
#Configure vxlan tunnel interface
VTEP1(config)#interface nve 1
VTEP1(config-if-nve1)#nve mode vxlan
VTEP1(config-if-nve1)#source 100.1.1.1
VTEP1(config-if-nve1)#destination 200.1.1.1
VTEP1(config-if-nve1)#join nvi 1
VTEP1(config-if-nve1)#join nvi 2
VTEP1(config-if-nve1)#description VTEP1
#Configure the vxlan access mapping relationship of the access port
VTEP1(config)#interface ethernet 1/0/1
VTEP1(config-if-ethernet1/0/1)#switchport mode access
VTEP1(config-if-ethernet1/0/1)#description VM1
VTEP1(config-if-ethernet1/0/1)#xconnect nvi 1 mode vlan svid 1
VTEP1(config)#interface ethernet 1/0/2
VTEP1(config-if-ethernet1/0/2)#switchport mode access
VTEP1(config-if-ethernet1/0/1)#description VM2
VTEP1(config-if-ethernet1/0/2)#xconnect nvi 2 mode vlan svid 2
```

(2) VTEP2 Configuration:

```
#Configure network virtual instance
VTEP2(config)#nvi 1
VTEP2(config-nvi)#vxlan-id 1
VTEP2(config-nvi)#description VM3
VTEP2(config)#nvi 2
VTEP2(config-nvi)#vxlan-id 2
VTEP2(config-nvi)#description VM4
#Configure vxlan tunnel interface
VTEP2(config)#interface nve 1
VTEP2(config-if-nve1)#nve mode vxlan
VTEP2(config-if-nve1)#source 200.1.1.1
VTEP2(config-if-nve1)#destination 100.1.1.1
VTEP2(config-if-nve1)#join nvi 1
VTEP2(config-if-nve1)#join nvi 2
VTEP2(config-if-nve1)#description VTEP2
#Configure the vxlan access mapping relationship of the access port
VTEP2(config)#interface ethernet 1/0/1
VTEP2(config-if-ethernet1/0/1)#switchport mode access
VTEP2(config-if-ethernet1/0/1)#description VM3
VTEP2(config-if-ethernet1/0/1)#xconnect nvi 1 mode vlan svid 1
VTEP2(config)#interface ethernet 1/0/2
VTEP2(config-if-ethernet1/0/2)#switchport mode access
VTEP2(config-if-ethernet1/0/1)#description VM4
VTEP2(config-if-ethernet1/0/2)#xconnect nvi 2 mode vlan svid 2
```

By configuring the vxlan access mapping relationship of the access port, VM1 and VM3 can be interconnected, VM2 and VM4 can be interconnected; VM1 and VM2, VM3 and VM4 can be isolated from each other and can not be interconnected.

12.3.3.2 EVPN VXLAN Layer 2 Interconnection

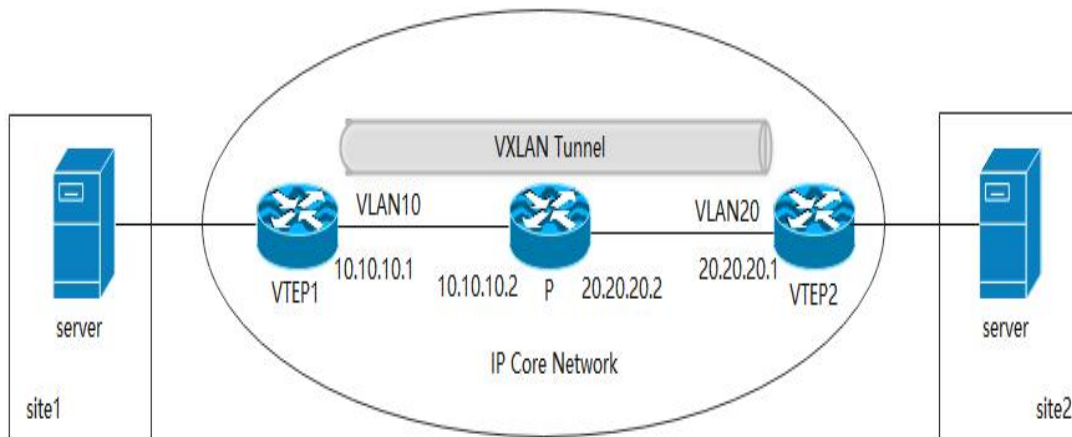

Figure 13-4 EVPN VXLAN layer 2 interconnection networking

VTEP1 Configuration:

#Configure interface vlan10 and loopback1

```
VTEP1(config)#interface vlan 10
```

```
VTEP1(config-if-vlan10)#ip address 10.10.10.1 255.255.255.0
```

```
VTEP1(config)#interface loopback 1
```

```
VTEP1(config-if-loopback1)#ip address 1.1.1.1 255.255.255.255
```

#Configure the global nve source address

```
VTEP1(config)#evpn nve source-address 1.1.1.1
```

#Configure virtual switch instance nvi 10 and enable evpn

```
VTEP1(config)#nvi 10
```

```
VTEP1(config-nvi)#vxlan-id 10
```

```
VTEP1(config-nvi)#evpn
```

```
VTEP1(config-nvi-evpn)#rd 1:1
```

```
VTEP1(config-nvi-evpn)#route-target both 1:1
```

```
VTEP1(config-nvi-evpn)#enable
```

#Configure service access

```
VTEP1(config)#interface ethernet 1/0/1
```

```
VTEP1(config-if-ethernet1/0/1)#switchport mode trunk
```

```
VTEP1(config-if-ethernet1/0/1)#xconnect nvi 10
```

#Start the ospf protocol and configure the ospf area to which the interface belongs

```
VTEP1(config)#router ospf
```

```
VTEP1(config-router)#ospf router-id 1.1.1.1
```

```
VTEP1(config-router)#network 1.1.1.1/32 area 0
```

```
VTEP1(config-router)#network 10.10.10.0/24 area 0
```

#Start the bgp protocol and declare evpn capability to the bgp peer

```
VTEP1(config)#router bgp 100
VTEP1(config-router)#neighbor 3.3.3.3 remote-as 100
VTEP1(config-router)#neighbor 3.3.3.3 update-source 1.1.1.1
VTEP1(config-router)#address-family l2vpn evpn
VTEP1(config-router-af)#neighbor 3.3.3.3 activate
VTEP1(config-router-af)#exit-address-family
```

P Configuration:

```
#Configure interface vlan10, vlan20 and loopback1
P(config)#interface vlan 10
P(config-if-vlan10)#ip address 10.10.10.2 255.255.255.0
P(config)#interface vlan 20
P(config-if-vlan20)#ip address 20.20.20.2 255.255.255.0
P(config)#interface loopback 1
P(config-if-loopback1)#ip address 2.2.2.2 255.255.255.255
#Start the ospf protocol and configure the ospf area to which the interface belongs
P(config)#router ospf
P(config-router)#ospf router-id 2.2.2.2
P(config-router)#network 2.2.2.2/32 area 0
P(config-router)#network 10.10.10.0/24 area 0
P(config-router)#network 20.20.20.0/24 area 0
```

VTEP2 Configuration:

```
#Configure interface vlan20 and loopback1
VTEP2(config)#interface vlan 20
VTEP2(config-if-vlan10)#ip address 20.20.20.1 255.255.255.0
VTEP2(config)#interface loopback 1
VTEP2(config-if-loopback1)#ip address 3.3.3.3 255.255.255.255
#Configure the global nve source address
VTEP2(config)#evpn nve source-address 3.3.3.3
#Configure virtual switch instance nvi 10 and enable evpn
VTEP2(config)#nvi 10
VTEP2(config-nvi)#vxlan-id 10
VTEP2(config-nvi)#evpn
VTEP2(config-nvi-evpn)#rd 2:2
VTEP2(config-nvi-evpn)#route-target both 1:1
VTEP2(config-nvi-evpn)#enable
#Configure service access
VTEP2(config)#interface ethernet 1/0/1
VTEP2(config-if-ethernet1/0/1)#switchport mode trunk
VTEP2(config-if-ethernet1/0/1)#xconnect nvi 10
#Start the ospf protocol and configure the ospf area to which the interface belongs
VTEP2(config)#router ospf
VTEP2(config-router)#ospf router-id 3.3.3.3
```

```

VTEP2(config-router)#network 3.3.3.3/32 area 0
VTEP2(config-router)#network 20.20.20.0/24 area 0
#Start the bgp protocol and declare evpn capability to the bgp peer
VTEP2(config)#router bgp 100
VTEP2(config-router)#neighbor 1.1.1.1 remote-as 100
VTEP2(config-router)#neighbor 1.1.1.1 update-source 3.3.3.3
VTEP2(config-router)#address-family l2vpn evpn
VTEP2(config-router-af)#neighbor 1.1.1.1 activate
VTEP2(config-router-af)#exit-address-family

```

12.3.3.3 VXLAN Centralized Gateway

12.3.3.3.1 EVPN VXLAN Centralized Gateway

EVPN usually adopts the layered structure of Spine—Leaf. The leaf layer device acts as a VTEP to perform EVPN-related processing on the packet; the spine layer device is the core device and forwards the packet according to the destination IP address of the packet.

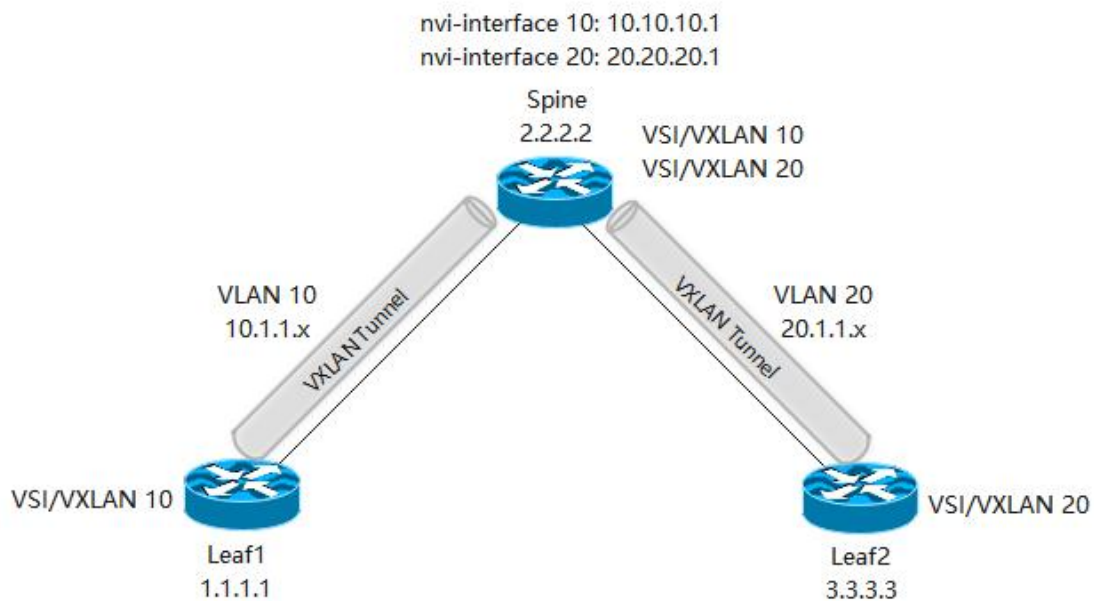

Figure 13-5 EVPN VXLAN centralized gateway

Spine Configuration:

```

#Configure interface vlan10, vlan20 and loopback1
Spine(config)#interface vlan 10
Spine(config-if-vlan10)#ip address 10.1.1.2 255.255.255.0
Spine(config)#interface vlan 20
Spine(config-if-vlan20)#ip address 20.1.1.2 255.255.255.0
Spine(config)#interface loopback 1
Spine(config-if-loopback1)#ip address 2.2.2.2 255.255.255.255
#Disable the nvi-vlan mapping monitor of EVPN
Spine(config)#evpn nvi-vlan-mapping-monitor disable

```

```
#Configure the global nve source address
Spine(config)#evpn nve source-address 2.2.2.2
#Configure virtual switch instance nvi 10, nvi 20 and enable evpn
Spine(config)#nvi 10
Spine(config-nvi)#vxlan-id 10
Spine(config-nvi)#evpn
Spine(config-nvi-evpn)#rd 10:10
Spine(config-nvi-evpn)#route-target both 1000:1000
Spine(config-nvi-evpn)#enable
Spine(config)#nvi 20
Spine(config-nvi)#vxlan-id 20
Spine(config-nvi)#evpn
Spine(config-nvi-evpn)#rd 20:20
Spine(config-nvi-evpn)#route-target both 2000:2000
Spine(config-nvi-evpn)#enable
#Configure the gateway interface of the virtual switch instance
Spine(config)#interface nvi-interface 10
Spine(config-if-nvi-interface10)#ipv6 address 10::1/64
Spine(config-if-nvi-interface10)#ip address 10.10.10.1 255.255.255.0
Spine(config)#interface nvi-interface 20
Spine(config-if-nvi-interface20)#ipv6 address 20::1/64
Spine(config-if-nvi-interface20)#ip address 20.20.20.1 255.255.255.0
#Start the ospf protocol and configure the ospf area to which the interface belongs
Spine(config)#router ospf 1
Spine(config-router)#ospf router-id 2.2.2.2
Spine(config-router)#network 2.2.2.2 0.0.0.0 area 0
Spine(config-router)#network 10.1.1.0 0.0.0.255 area 0
Spine(config-router)#network 20.1.1.0 0.0.0.255 area 0
#Start the bgp protocol and declare evpn capability to the bgp peer
Spine(config)#router bgp 100
Spine(config-router)#neighbor 1.1.1.1 remote-as 100
Spine(config-router)#neighbor 1.1.1.1 update-source 2.2.2.2
Spine(config-router)#neighbor 3.3.3.3 remote-as 100
Spine(config-router)#neighbor 3.3.3.3 update-source 2.2.2.2
Spine(config-router)#address-family l2vpn evpn
Spine(config-router-af)#neighbor 1.1.1.1 activate
Spine(config-router-af)#neighbor 3.3.3.3 activate
Spine(config-router-af)#exit-address-family
```

Leaf1 Configuration:

```
#Configure interface vlan10 and loopback1
Leaf1(config)#interface vlan 10
Leaf1(config-if-vlan10)#ip address 10.1.1.1 255.255.255.0
Leaf1(config)#interface loopback 1
```

```
Leaf1(config-if-loopback1)#ip address 1.1.1.1 255.255.255.255
#Configure the global nve source address
Leaf1(config)#evpn nve source-address 1.1.1.1
#Configure virtual switch instance nvi 10 and enable evpn
Leaf1(config)#nvi 10
Leaf1(config-nvi)#vxlan-id 10
Leaf1(config-nvi)#evpn
Leaf1(config-nvi-evpn)#rd 1:1
Leaf1(config-nvi-evpn)#route-target both 1000:1000
Leaf1(config-nvi-evpn)#enable
#Configure ARP/ND suppression
Leaf1(config-nvi)#arp suppression enable
Leaf1(config-nvi)#nd suppression enable
#Configure service access
Leaf1(config)#interface ethernet 1/0/5
Leaf1(config-if-ethernet1/0/5)#xconnect nvi 10 mode vlan svid 100
#Start the ospf protocol and configure the ospf area to which the interface belongs
Leaf1(config)#router ospf 1
Leaf1(config-router)#ospf router-id 1.1.1.1
Leaf1(config-router)#network 1.1.1.1 0.0.0.0 area 0
Leaf1(config-router)#network 10.1.1.0 0.0.0.255 area 0
#Start the bgp protocol and declare evpn capability to the bgp peer
Leaf1(config)#router bgp 100
Leaf1(config-router)#neighbor 2.2.2.2 remote-as 100
Leaf1(config-router)#neighbor 2.2.2.2 update-source 1.1.1.1
Leaf1(config-router)#address-family l2vpn evpn
Leaf1(config-router-af)#neighbor 2.2.2.2 activate
Leaf1(config-router-af)#exit-address-family
```

Leaf2 Configuration:

```
#Configure interface vlan20 and loopback1
Leaf2(config)#interface vlan 20
Leaf2(config-if-vlan20)#ip address 20.1.1.1 255.255.255.0
Leaf2(config)#interface loopback 1
Leaf2(config-if-loopback1)#ip address 3.3.3.3 255.255.255.255
#Configure the global nve source address
Leaf2(config)#evpn nve source-address 3.3.3.3
#Configure virtual switch instance nvi 20 and enable evpn
Leaf2(config)#nvi 20
Leaf2(config-nvi)#vxlan-id 20
Leaf2(config-nvi)#evpn
Leaf2(config-nvi-evpn)#rd 2:2
Leaf2(config-nvi-evpn)#route-target both 2000:2000
Leaf2(config-nvi-evpn)#enable
```

```

#Configure ARP/ND suppression
Leaf2(config-nvi)#arp suppression enable
Leaf2(config-nvi)#nd suppression enable
#Configure service access
Leaf2(config)#interface ethernet 1/0/5
Leaf2(config-if-ethernet1/0/5)#xconnect nvi 20 mode vlan svid 100
#Start the ospf protocol and configure the ospf area to which the interface belongs
Leaf2(config)#router ospf 1
Leaf2(config-router)#ospf router-id 3.3.3.3
Leaf2(config-router)#network 3.3.3.3 0.0.0.0 area 0
Leaf2(config-router)#network 20.1.1.0 0.0.0.255 area 0
#Start the bgp protocol and declare evpn capability to the bgp peer
Leaf2(config)#router bgp 100
Leaf2(config-router)#neighbor 2.2.2.2 remote-as 100
Leaf2(config-router)#neighbor 2.2.2.2 update-source 3.3.3.3
Leaf2(config-router)#address-family l2vpn evpn
Leaf2(config-router-af)#neighbor 2.2.2.2 activate
Leaf2(config-router-af)#exit-address-family

```

12.3.3.3.2 Static VXLAN Centralized Gateway

Refer to section 13.1.3.1.

12.3.3.4 EVPN VXLAN Distributed Gateway

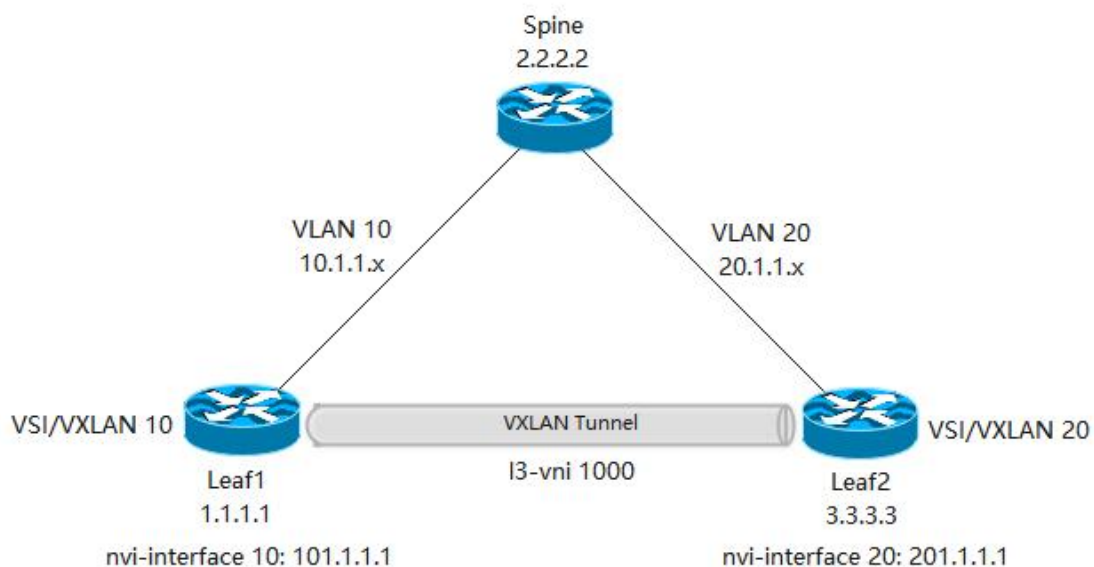

Figure 13-6 EVPN VXLAN distributed gateway

Spine Configuration:

```
#Configure interface vlan10, vlan20 and loopback1
```



```
Spine(config)#interface vlan 10
Spine(config-if-vlan10)#ip address 10.1.1.2 255.255.255.0
Spine(config)#interface vlan 20
Spine(config-if-vlan20)#ip address 20.1.1.2 255.255.255.0
Spine(config)#interface loopback 1
Spine(config-if-loopback1)#ip address 2.2.2.2 255.255.255.255
#Start the ospf protocol and configure the ospf area to which the interface belongs
Spine(config)#router ospf 1
Spine(config-router)#ospf router-id 2.2.2.2
Spine(config-router)#network 2.2.2.2 0.0.0.0 area 0
Spine(config-router)#network 10.1.1.0 0.0.0.255 area 0
Spine(config-router)#network 20.1.1.0 0.0.0.255 area 0
```

Leaf1 Configuration:

```
#Configure interface vlan10 and loopback1
Leaf1(config)#interface vlan 10
Leaf1(config-if-vlan10)#ip address 10.1.1.1 255.255.255.0
Leaf1(config)#interface loopback 1
Leaf1(config-if-loopback1)#ip address 1.1.1.1 255.255.255.255
#Configure the global nve source address
Leaf1(config)#evpn nve source-address 1.1.1.1
#Disable the automatic learning function of remote MAC/ARP/ND
Leaf1(config)#vxlan remote mac-address-learning disable
Leaf1(config)#vxlan remote arp-learning disable
Leaf1(config)#vxlan remote nd-learning disable
#Configure virtual switch instance nvi 10 and enable evpn
Leaf1(config)#nvi 10
Leaf1(config-nvi)#vxlan-id 10
Leaf1(config-nvi)#evpn
Leaf1(config-nvi-evpn)#rd 1:1
Leaf1(config-nvi-evpn)#route-target both 1000:1000
Leaf1(config-nvi-evpn)#enable
#Configure ARP/ND suppression
Leaf1(config-nvi)#arp suppression enable
Leaf1(config-nvi)#nd suppression enable
#Configure service access
Leaf1(config)#interface ethernet 1/0/5
Leaf1(config-if-ethernet1/0/5)#xconnect nvi 10 mode vlan svid 100
#Configure L3VPN instance and associate with l3-vni 1000
Leaf1(config)#ip vrf vpn1
Leaf1(config-vrf)#rd 11:1
Leaf1(config-vrf)#route-target both 10:1
Leaf1(config-vrf)#l3-vni 1000
#Configure the distributed gateway interface of the virtual switch instance
```

```
Leaf1(config)#interface nvi-interface 10
Leaf1(config-if-nvi-interface10)#ip vrf forwarding vpn1
Leaf1(config-if-nvi-interface10)#mac-address 00-ff-ff-00-00-01
Leaf1(config-if-nvi-interface10)#distributed-gateway enable
Leaf1(config-if-nvi-interface10)#ipv6 address 1001::1/64
Leaf1(config-if-nvi-interface10)#ip address 101.1.1.1 255.255.255.0
#Start the ospf protocol and configure the ospf area to which the interface belongs
Leaf1(config)#router ospf 1
Leaf1(config-router)#ospf router-id 1.1.1.1
Leaf1(config-router)#network 1.1.1.1 0.0.0.0 area 0
Leaf1(config-router)#network 10.1.1.0 0.0.0.255 area 0
#Start the bgp protocol and declare evpn capability to the bgp peer
Leaf1(config)#router bgp 100
Leaf1(config-router)#neighbor 3.3.3.3 remote-as 100
Leaf1(config-router)#neighbor 3.3.3.3 update-source 1.1.1.1
Leaf1(config-router)#address-family l2vpn evpn
Leaf1(config-router-af)#neighbor 3.3.3.3 activate
Leaf1(config-router-af)#exit-address-family
Leaf1(config-router)#address-family ipv4 vrf vpn1
Leaf1(config-router-af)#redistribute connected
Leaf1(config-router-af)#exit-address-family
```

Leaf2 Configuration:

```
#Configure interface vlan20 and loopback1
Leaf2(config)#interface vlan 20
Leaf2(config-if-vlan20)#ip address 20.1.1.1 255.255.255.0
Leaf2(config)#interface loopback 1
Leaf2(config-if-loopback1)#ip address 3.3.3.3 255.255.255.255
#Configure the global nve source address
Leaf2(config)#evpn nve source-address 3.3.3.3
#Disable the automatic learning function of remote MAC/ARP/ND
Leaf2(config)#vxlan remote mac-address-learning disable
Leaf2(config)#vxlan remote arp-learning disable
Leaf2(config)#vxlan remote nd-learning disable
#Configure virtual switch instance nvi 20 and enable evpn
Leaf2(config)#nvi 20
Leaf2(config-nvi)#vxlan-id 20
Leaf2(config-nvi)#evpn
Leaf2(config-nvi-evpn)#rd 2:2
Leaf2(config-nvi-evpn)#route-target both 1000:1000
Leaf2(config-nvi-evpn)#enable
#Configure ARP/ND suppression
Leaf2(config-nvi)#arp suppression enable
Leaf2(config-nvi)#nd suppression enable
```

```
#Configure service access
Leaf2(config)#interface ethernet 1/0/5
Leaf2(config-if-ethernet1/0/5)#xconnect nvi 20 mode vlan svid 100
#Configure L3VPN instance and associate with l3-vni 1000
Leaf2(config)#ip vrf vpn1
Leaf2(config-vrf)#rd 11:1
Leaf2(config-vrf)#route-target both 10:1
Leaf2(config-vrf)#l3-vni 1000
#Configure the distributed gateway interface of the virtual switch instance
Leaf2(config)#interface nvi-interface 20
Leaf2(config-if-nvi-interface20)#ip vrf forwarding vpn1
Leaf2(config-if-nvi-interface20)#mac-address 00-ff-ff-00-00-02
Leaf2(config-if-nvi-interface20)#distributed-gateway enable
Leaf2(config-if-nvi-interface20)#ipv6 address 2001::1/64
Leaf2(config-if-nvi-interface20)#ip address 201.1.1.1 255.255.0.0
#Start the ospf protocol and configure the ospf area to which the interface belongs
Leaf2(config)#router ospf 1
Leaf2(config-router)#ospf router-id 3.3.3.3
Leaf2(config-router)#network 3.3.3.3 0.0.0.0 area 0
Leaf2(config-router)#network 20.1.1.0 0.0.0.255 area 0
#Start the bgp protocol and declare evpn capability to the bgp peer
Leaf2(config)#router bgp 100
Leaf2(config-router)#neighbor 1.1.1.1 remote-as 100
Leaf2(config-router)#neighbor 1.1.1.1 update-source 3.3.3.3
Leaf2(config-router)#address-family l2vpn evpn
Leaf2(config-router-af)#neighbor 1.1.1.1 activate
Leaf2(config-router-af)#exit-address-family
Leaf2(config-router)#address-family ipv4 vrf vpn1
Leaf2(config-router-af)#redistribute connected
Leaf2(config-router-af)#exit-address-family
```

12.3.3.5 VXLAN Centralized Multi-Active Gateway

12.3.3.5.1 EVPN VXLAN Centralized Multi-Active Gateway

After the two spines start the VEG function and configure the same NVE source address, and bind the VEG to the NVI interface, the synchronization service of ARP and ND will be automatically enabled.

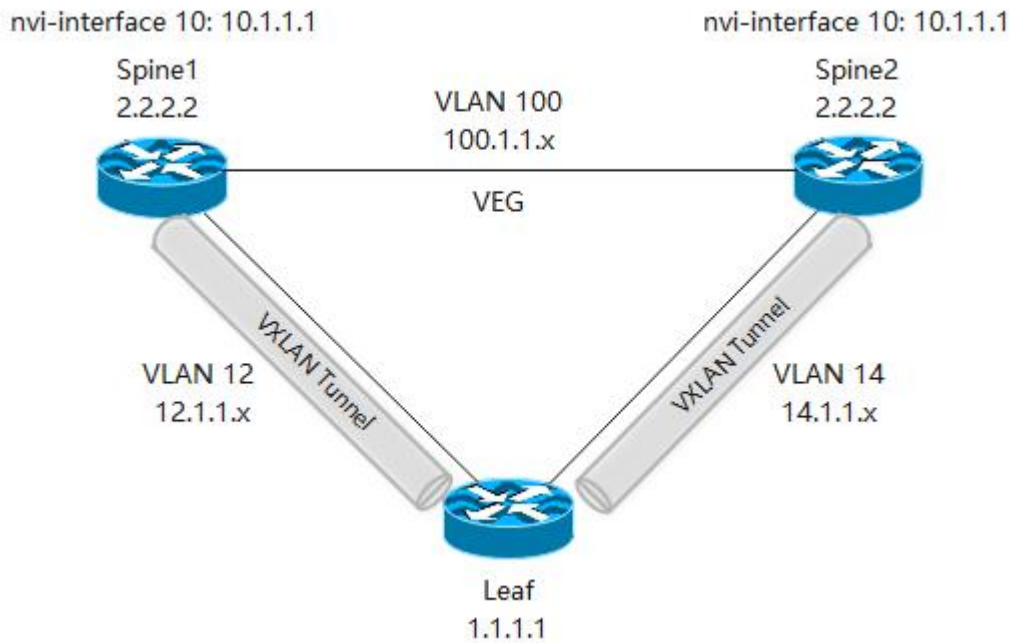

Figure 13-7 EVPN VXLAN centralized multi-active gateway

Spine1 Configuration:

#Configure interface vlan12, vlan100, loopback1 and loopback2

```
Spine1(config)#interface vlan 12
```

```
Spine1(config-if-vlan12)#ip address 12.1.1.2 255.255.255.0
```

```
Spine1(config)#interface vlan 100
```

```
Spine1(config-if-vlan100)#ip address 100.1.1.3 255.255.255.0
```

```
Spine1(config)#interface loopback 1
```

```
Spine1(config-if-loopback1)#ip address 2.2.2.2 255.255.255.255
```

```
Spine1(config)#interface loopback 2
```

```
Spine1(config-if-loopback2)#ip address 5.5.5.5 255.255.255.255
```

#Configure the global nve source address

```
Spine1(config)#evpn nve source-address 2.2.2.2
```

#Disable the nvi-vlan mapping monitor of EVPN

```
Spine1(config)#evpn nvi-vlan-mapping-monitor disable
```

#Configure the virtual equipment group

```
Spine1(config)#virtual-equipment-group 1
```

```
Spine1(config-veg1)#source ip 100.1.1.3
```

```
Spine1(config-veg1)#remote ip 100.1.1.2
```

#Configure virtual switch instance nvi 10 and enable evpn

```
Spine1(config)#nvi 10
```

```
Spine1(config-nvi)#vxlan-id 10
```

```
Spine1(config-nvi)#evpn
```

```
Spine1(config-nvi-evpn)#rd 1:1
```

```
Spine1(config-nvi-evpn)#route-target both 1000:1000
```

```
Spine1(config-nvi-evpn)#enable
```

#Configure the gateway interface of the virtual switch instance

```
Spine1(config)#interface nvi-interface 10
Spine1(config-if-nvi-interface10)#mac-address 90-3c-bb-aa-ee-ff
Spine1(config-if-nvi-interface10)#ipv6 address 10::1/64
Spine1(config-if-nvi-interface10)#virtual-equipment-group 1
Spine1(config-if-nvi-interface10)#ip address 10.1.1.1 255.255.255.0
#Start the ospf protocol and configure the ospf area to which the interface belongs
Spine1(config)#router ospf 1
Spine1(config-router)#ospf router-id 5.5.5.5
Spine1(config-router)#network 2.2.2.2 0.0.0.0 area 0
Spine1(config-router)#network 5.5.5.5 0.0.0.0 area 0
Spine1(config-router)#network 12.1.1.0 0.0.0.255 area 0
Spine1(config-router)#network 100.1.1.0 0.0.0.255 area 0
#Start the bgp protocol and declare evpn capability to the bgp peer
Spine1(config)#router bgp 100
Spine1(config-router)#neighbor 1.1.1.1 remote-as 100
Spine1(config-router)#neighbor 1.1.1.1 update-source 5.5.5.5
Spine1(config-router)#address-family l2vpn evpn
Spine1(config-router-af)#neighbor 1.1.1.1 activate
Spine1(config-router-af)#exit-address-family
```

Spine2 Configuration:

```
#Configure interface vlan14, vlan100, loopback1 and loopback2
Spine2(config)#interface vlan 14
Spine2(config-if-vlan14)#ip address 14.1.1.2 255.255.255.0
Spine2(config)#interface vlan 100
Spine2(config-if-vlan100)#ip address 100.1.1.2 255.255.255.0
Spine2(config)#interface loopback 1
Spine2(config-if-loopback1)#ip address 2.2.2.2 255.255.255.255
Spine2(config)#interface loopback 2
Spine2(config-if-loopback2)#ip address 6.6.6.6 255.255.255.255
#Configure the global nve source address
Spine2(config)#evpn nve source-address 2.2.2.2
#Disable the nvi-vlan mapping monitor of EVPN
Spine2(config)#evpn nvi-vlan-mapping-monitor disable
#Configure the virtual equipment group
Spine2(config)#virtual-equipment-group 1
Spine2(config-veg1)#source ip 100.1.1.2
Spine2(config-veg1)#remote ip 100.1.1.3
#Configure virtual switch instance nvi 10 and enable evpn
Spine2(config)#nvi 10
Spine2(config-nvi)#vxlan-id 10
Spine2(config-nvi)#evpn
Spine2(config-nvi-evpn)#rd 1:1
Spine2(config-nvi-evpn)#route-target both 1000:1000
```

```
Spine2(config-nvi-evpn)#enable
#Configure the gateway interface of the virtual switch instance
Spine2(config)#interface nvi-interface 10
Spine2(config-if-nvi-interface10)#mac-address 90-3c-bb-aa-ee-ff
Spine2(config-if-nvi-interface10)#ipv6 address 10::1/64
Spine2(config-if-nvi-interface10)#virtual-equipment-group 1
Spine2(config-if-nvi-interface10)#ip address 10.1.1.1 255.255.255.0
#Start the ospf protocol and configure the ospf area to which the interface belongs
Spine2(config)#router ospf 1
Spine2(config-router)#ospf router-id 6.6.6.6
Spine2(config-router)#network 2.2.2.2 0.0.0.0 area 0
Spine2(config-router)#network 6.6.6.6 0.0.0.0 area 0
Spine2(config-router)#network 14.1.1.0 0.0.0.255 area 0
Spine2(config-router)#network 100.1.1.0 0.0.0.255 area 0
#Start the bgp protocol and declare evpn capability to the bgp peer
Spine2(config)#router bgp 100
Spine2(config-router)#neighbor 1.1.1.1 remote-as 100
Spine2(config-router)#neighbor 1.1.1.1 update-source 6.6.6.6
Spine2(config-router)#address-family l2vpn evpn
Spine2(config-router-af)#neighbor 1.1.1.1 activate
Spine2(config-router-af)#exit-address-family
```

Leaf Configuration:

```
#Configure interface vlan12, vlan14 and loopback1
Leaf(config)#interface vlan 12
Leaf(config-if-vlan12)#ip address 12.1.1.1 255.255.255.0
Leaf(config)#interface vlan 14
Leaf(config-if-vlan14)#ip address 14.1.1.1 255.255.255.0
Leaf(config)#interface loopback 1
Leaf(config-if-loopback1)#ip address 1.1.1.1 255.255.255.255
#Configure the global nve source address
Leaf(config)#evpn nve source-address 1.1.1.1
#Configure virtual switch instance nvi 10 and enable evpn
Leaf(config)#nvi 10
Leaf(config-nvi)#vxlan-id 10
Leaf(config-nvi)#evpn
Leaf(config-nvi-evpn)#rd 1:1
Leaf(config-nvi-evpn)#route-target both 1000:1000
Leaf(config-nvi-evpn)#enable
#Configure ARP/ND suppression
Leaf(config-nvi)#arp suppression enable
Leaf(config-nvi)#nd suppression enable
#Configure service access
Leaf(config)#interface ethernet 1/0/5
```

```

Leaf(config-if-ethernet1/0/5)#xconnect nvi 10 mode vlan svid 100
#Start the ospf protocol and configure the ospf area to which the interface belongs
Leaf(config)#router ospf 1
Leaf(config-router)#ospf router-id 1.1.1.1
Leaf(config-router)#network 1.1.1.1 0.0.0.0 area 0
Leaf(config-router)#network 12.1.1.0 0.0.0.255 area 0
Leaf(config-router)#network 14.1.1.0 0.0.0.255 area 0
#Start the bgp protocol and declare evpn capability to the bgp peer
Leaf(config)#router bgp 100
Leaf(config-router)#neighbor 5.5.5.5 remote-as 100
Leaf(config-router)#neighbor 5.5.5.5 update-source 1.1.1.1
Leaf(config-router)#neighbor 6.6.6.6 remote-as 100
Leaf(config-router)#neighbor 6.6.6.6 update-source 1.1.1.1
Leaf(config-router)#address-family l2vpn evpn
Leaf(config-router-af)#neighbor 5.5.5.5 activate
Leaf(config-router-af)#neighbor 6.6.6.6 activate
Leaf(config-router-af)#exit-address-family

```

12.3.3.5.2 Static VXLAN Centralized Multi-Active Gateway

Refer to section 13.1.3.1.

12.3.3.6 EVPN VXLAN Dual Homing Access

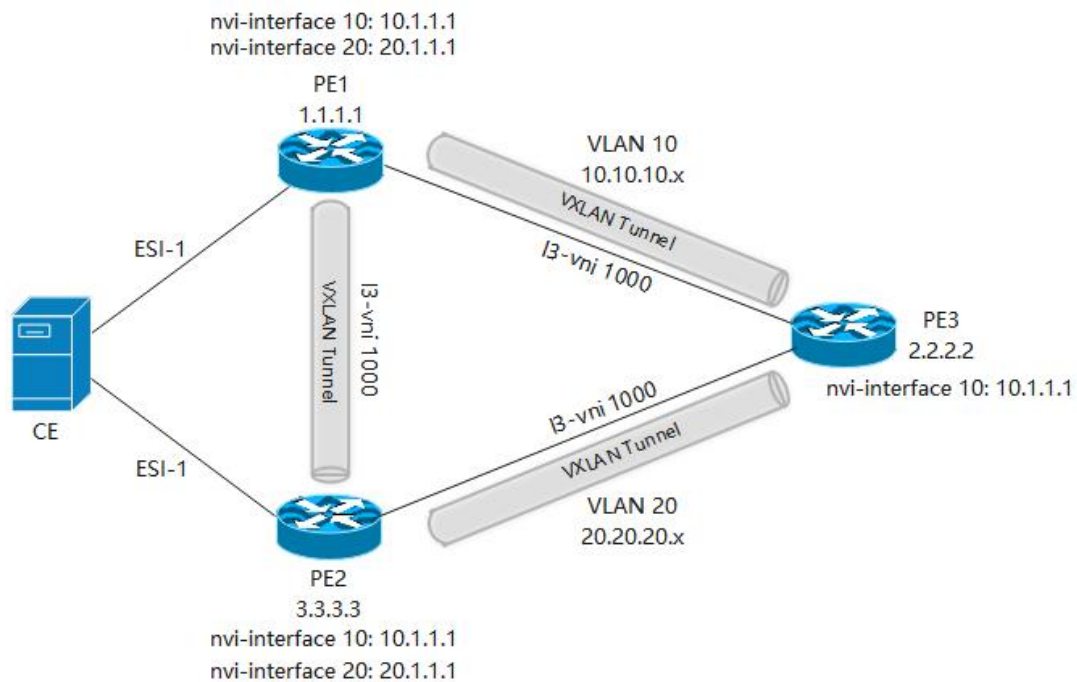

Figure 13-8 EVPN VXLAN dual homing access

PE1 Configuration:

```
#Configure interface vlan10 and loopback1
PE1(config)#interface vlan 10
PE1(config-if-vlan10)#ip address 10.10.10.1 255.255.255.0
PE1(config)#interface loopback 1
PE1(config-if-loopback1)#ip address 1.1.1.1 255.255.255.255
#Configure the global nve source address
PE1(config)#evpn nve source-address 1.1.1.1
#Disable the automatic learning function of remote MAC/ARP/ND
PE1(config)#vxlan remote mac-address-learning disable
PE1(config)#vxlan remote arp-learning disable
PE1(config)#vxlan remote nd-learning disable
#Configure virtual switch instance nvi 10, nvi 20 and enable evpn
PE1(config)#nvi 10
PE1(config-nvi)#vxlan-id 10
PE1(config-nvi)#evpn
PE1(config-nvi-evpn)#rd 1:1
PE1(config-nvi-evpn)#route-target both 100:100
PE1(config-nvi-evpn)#enable
PE1(config)#nvi 20
PE1(config-nvi)#vxlan-id 20
PE1(config-nvi)#evpn
PE1(config-nvi-evpn)#rd 30:30
PE1(config-nvi-evpn)#route-target both 200:200
PE1(config-nvi-evpn)#enable
#Configure service access and associate with esi
PE1(config)#interface ethernet 1/0/5
PE1(config-if-ethernet1/0/5)#xconnect nvi 10 mode vlan svid 100
PE1(config-if-ethernet1/0/5)#xconnect nvi 20 mode vlan svid 200
PE1(config-if-ethernet1/0/5)#esi 0011.2222.3333.4444.4444
#Configure L3VPN instance and associate with l3-vni 1000
PE1(config)#ip vrf vpn1
PE1(config-vrf)#rd 33:1
PE1(config-vrf)#route-target both 100:1
PE1(config-vrf)#l3-vni 1000
#Configure the distributed gateway interface of the virtual switch instance
PE1(config)#interface nvi-interface 10
PE1(config-if-nvi-interface10)#ip vrf forwarding vpn1
PE1(config-if-nvi-interface10)#mac-address 00-00-33-33-99-99
PE1(config-if-nvi-interface10)#distributed-gateway enable
PE1(config-if-nvi-interface10)#ipv6 address 2103::1/64
PE1(config-if-nvi-interface10)#ip address 10.1.1.1 255.255.255.0
PE1(config)#interface nvi-interface 20
PE1(config-if-nvi-interface20)#ip vrf forwarding vpn1
```



```
PE1(config-if-nvi-interface20)#mac-address 00-00-33-34-99-99
PE1(config-if-nvi-interface20)#distributed-gateway enable
PE1(config-if-nvi-interface20)#ipv6 address 2203::1/64
PE1(config-if-nvi-interface20)#ip address 20.1.1.1 255.255.255.0
#Start the ospf protocol and configure the ospf area to which the interface belongs
PE1(config)#router ospf 1
PE1(config-router)#ospf router-id 1.1.1.1
PE1(config-router)#network 1.1.1.1 0.0.0.0 area 0
PE1(config-router)#network 10.10.10.0 0.0.0.255 area 0
#Start the bgp protocol and declare evpn capability to the bgp peer
PE1(config)#router bgp 100
PE1(config-router)#neighbor 2.2.2.2 remote-as 100
PE1(config-router)#neighbor 2.2.2.2 update-source 1.1.1.1
PE1(config-router)#neighbor 3.3.3.3 remote-as 100
PE1(config-router)#neighbor 3.3.3.3 update-source 1.1.1.1
PE1(config-router)#address-family l2vpn evpn
PE1(config-router-af)#neighbor 2.2.2.2 activate
PE1(config-router-af)#neighbor 3.3.3.3 activate
PE1(config-router-af)#exit-address-family
PE1(config-router)#address-family ipv4 vrf vpn1
PE1(config-router-af)#redistribute connected
PE1(config-router-af)#exit-address-family
```

PE2 Configuration:

```
#Configure interface vlan20 and loopback1
PE2(config)#interface vlan 20
PE2(config-if-vlan20)#ip address 20.20.20.1 255.255.255.0
PE2(config)#interface loopback 1
PE2(config-if-loopback1)#ip address 3.3.3.3 255.255.255.255
#Configure the global nve source address
PE2(config)#evpn nve source-address 3.3.3.3
#Disable the automatic learning function of remote MAC/ARP/ND
PE2(config)#vxlan remote mac-address-learning disable
PE2(config)#vxlan remote arp-learning disable
PE2(config)#vxlan remote nd-learning disable
#Configure virtual switch instance nvi 10, nvi 20 and enable evpn
PE2(config)#nvi 10
PE2(config-nvi)#vxlan-id 10
PE2(config-nvi)#evpn
PE2(config-nvi-evpn)#rd 3:3
PE2(config-nvi-evpn)#route-target both 100:100
PE2(config-nvi-evpn)#enable
PE2(config)#nvi 20
PE2(config-nvi)#vxlan-id 20
```

```
PE2(config-nvi)#evpn
PE2(config-nvi-evpn)#rd 30:30
PE2(config-nvi-evpn)#route-target both 200:200
PE2(config-nvi-evpn)#enable
#Configure service access and associate with esi
PE2(config)#interface ethernet 1/0/5
PE2(config-if-ethernet1/0/5)#xconnect nvi 10 mode vlan svid 100
PE2(config-if-ethernet1/0/5)#xconnect nvi 20 mode vlan svid 200
PE2(config-if-ethernet1/0/5)#esi 0011.2222.3333.4444.4444
#Configure L3VPN instance and associate with l3-vni 1000
PE2(config)#ip vrf vpn1
PE2(config-vrf)#rd 33:1
PE2(config-vrf)#route-target both 100:1
PE2(config-vrf)#l3-vni 1000
#Configure the distributed gateway interface of the virtual switch instance
PE2(config)#interface nvi-interface 10
PE2(config-if-nvi-interface10)#ip vrf forwarding vpn1
PE2(config-if-nvi-interface10)#mac-address 00-00-33-33-99-99
PE2(config-if-nvi-interface10)#distributed-gateway enable
PE2(config-if-nvi-interface10)#ipv6 address 2103::1/64
PE2(config-if-nvi-interface10)#ip address 10.1.1.1 255.255.255.0
PE2(config)#interface nvi-interface 20
PE2(config-if-nvi-interface20)#ip vrf forwarding vpn1
PE2(config-if-nvi-interface20)#mac-address 00-00-33-34-99-99
PE2(config-if-nvi-interface20)#distributed-gateway enable
PE2(config-if-nvi-interface20)#ipv6 address 2203::1/64
PE2(config-if-nvi-interface20)#ip address 20.1.1.1 255.255.255.0
#Start the ospf protocol and configure the ospf area to which the interface belongs
PE2(config)#router ospf 1
PE2(config-router)#ospf router-id 3.3.3.3
PE2(config-router)#network 3.3.3.3 0.0.0.0 area 0
PE2(config-router)#network 20.20.20.0 0.0.0.255 area 0
#Start the bgp protocol and declare evpn capability to the bgp peer
PE2(config)#router bgp 100
PE2(config-router)#neighbor 2.2.2.2 remote-as 100
PE2(config-router)#neighbor 2.2.2.2 update-source 3.3.3.3
PE2(config-router)#neighbor 1.1.1.1 remote-as 100
PE2(config-router)#neighbor 1.1.1.1 update-source 3.3.3.3
PE2(config-router)#address-family l2vpn evpn
PE2(config-router-af)#neighbor 2.2.2.2 activate
PE2(config-router-af)#neighbor 1.1.1.1 activate
PE2(config-router-af)#exit-address-family
PE2(config-router)#address-family ipv4 vrf vpn1
PE2(config-router-af)#redistribute connected
```

```
PE2(config-router-af)#exit-address-family
```

PE3 Configuration:

```
#Configure interface vlan10, vlan20 and loopback1
```

```
PE3(config)#interface vlan 10
```

```
PE3(config-if-vlan10)#ip address 10.10.10.2 255.255.255.0
```

```
PE3(config)#interface vlan 20
```

```
PE3(config-if-vlan20)#ip address 20.20.20.2 255.255.255.0
```

```
PE3(config)#interface loopback 1
```

```
PE3(config-if-loopback1)#ip address 2.2.2.2 255.255.255.255
```

```
#Configure the global nve source address
```

```
PE3(config)#evpn nve source-address 2.2.2.2
```

```
#Disable the automatic learning function of remote MAC/ARP/ND
```

```
PE3(config)#vxlan remote mac-address-learning disable
```

```
PE3(config)#vxlan remote arp-learning disable
```

```
PE3(config)#vxlan remote nd-learning disable
```

```
#Configure virtual switch instance nvi 10 and enable evpn
```

```
PE3(config)#nvi 10
```

```
PE3(config-nvi)#vxlan-id 10
```

```
PE3(config-nvi)#evpn
```

```
PE3(config-nvi-evpn)#rd 2:2
```

```
PE3(config-nvi-evpn)#route-target both 100:100
```

```
PE3(config-nvi-evpn)#enable
```

```
#Configure L3VPN instance and associate with l3-vni 1000
```

```
PE3(config)#ip vrf vpn1
```

```
PE3(config-vrf)#rd 1:1
```

```
PE3(config-vrf)#route-target both 100:1
```

```
PE3(config-vrf)#l3-vni 1000
```

```
#Configure the distributed gateway interface of the virtual switch instance
```

```
PE3(config)#interface nvi-interface 10
```

```
PE3(config-if-nvi-interface10)#ip vrf forwarding vpn1
```

```
PE3(config-if-nvi-interface10)#mac-address 00-00-33-33-99-99
```

```
PE3(config-if-nvi-interface10)#distributed-gateway enable
```

```
PE3(config-if-nvi-interface10)#ipv6 address 2103::1/64
```

```
PE3(config-if-nvi-interface10)#ip address 10.1.1.1 255.255.255.0
```

```
#Start the ospf protocol and configure the ospf area to which the interface belongs
```

```
PE3(config)#router ospf 1
```

```
PE3(config-router)#ospf router-id 2.2.2.2
```

```
PE3(config-router)#network 2.2.2.2 0.0.0.0 area 0
```

```
PE3(config-router)#network 10.10.10.0 0.0.0.255 area 0
```

```
PE3(config-router)#network 20.20.20.0 0.0.0.255 area 0
```

```
#Start the bgp protocol and declare evpn capability to the bgp peer
```

```
PE3(config)#router bgp 100
```

```
PE3(config-router)#neighbor 3.3.3.3 remote-as 100
```

```
PE3(config-router)#neighbor 3.3.3.3 update-source 2.2.2.2
PE3(config-router)#neighbor 1.1.1.1 remote-as 100
PE3(config-router)#neighbor 1.1.1.1 update-source 2.2.2.2
PE3(config-router)#address-family l2vpn evpn
PE3(config-router-af)#neighbor 3.3.3.3 activate
PE3(config-router-af)#neighbor 1.1.1.1 activate
PE3(config-router-af)#exit-address-family
PE3(config-router)#address-family ipv4 vrf vpn1
PE3(config-router-af)#redistribute connected
PE3(config-router-af)#exit-address-family
```

12.3.4 VXLAN Troubleshooting

In the process of configuring and implementing VXLAN service, physical connection, configuration false probably leads to VXLAN service doesn't work. Therefore, the customers should give their attention to points as follow:

- ☞ First of all, to ensure correct physical connection;
- ☞ Secondly, to ensure interface and link protocol are UP (execute **show interface** instruction);
- ☞ Then, it should be ensured that the OSPF neighbors between VTEP1, P, and VTEP2 are established normally, the routes including loopback interfaces are advertised normally, and the BGP neighbors between VTEPs are successfully established;
- ☞ After configuration finishes, the command of **show ip bgp summary** can be used to observe neighbor' s connections, so that all of the neighbors keep BGP connection situation. And use **show ip bgp evpn all** command to observe BGP EVPN routing table, use **show ip route** command to observe IP routing table;
- ☞ Finally, use the show command to view the statistics of received and sent packets on the nvi and nve interfaces for troubleshooting.

Chapter 13 IPv6 Configuration

13.1 DHCPv6

13.1.1 Introduction to DHCPv6

DHCPv6 [RFC3315] is the IPv6 version for Dynamic Host Configuration Protocol (DHCP). It is a protocol that assigns IPv6 address as well as other network configuration parameters such as DNS address, and domain name to DHCPv6 client, DHCPv6 is a conditional auto address configuration protocol relative to IPv6. In the conditional address configuration process, DHCPv6 server assigns a complete IPv6 address to client, and provides DNS address, domain name and other configuration information, maybe the DHCPv6 packet can transmit through relay delegation, at last the binding of IPv6 address and client can be recorded by DHCPv6 server, all that can enhance the management of network; DHCPv6 server can also provide non state DHCPv6 service, that is only assigns DNS address and domain name and other configuration information but not assigns IPv6 address, it can solve the bug of IPv6 auto address configuration in non state; DHCPv6 can provide extend function of DHCPv6 prefix delegation, upstream route can assign address prefix to downstream route automatically, that achieve the IPv6 address auto assignment in levels of network environment, and resolved the problem of ISP and IPv6 network dispose.

There are three entities in the DHCPv6 protocol – the client, the relay and the server. The DHCPv6 protocol is based on the UDP protocol. The DHCPv6 client sends request messages to the DHCP server or DHCP relay with the destination port as 547, and the DHCPv6 server and relay send replying messages with the destination port as 546. The DHCPv6 client sends solicit or request messages with the multicast address – ff02::1:2 for DHCP relay and server.

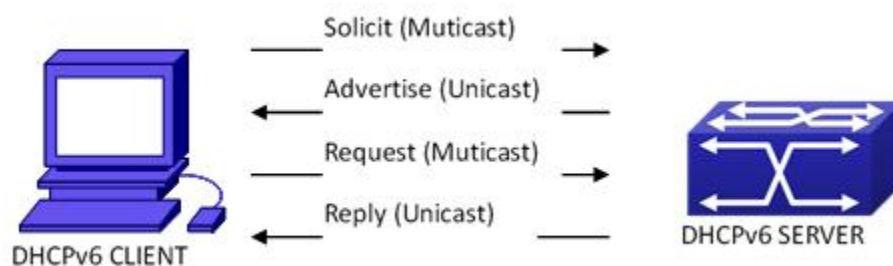

Figure 14- 1 DHCPv6 negotiation

When a DHCPv6 client tries to request an IPv6 address and other configurations from the DHCPv6 server, the client has to find the location of the DHCP server, and then request configurations from the DHCP server.

1. In the time of located server, the DHCP client tries to find a DHCPv6 server by broadcasting a SOLICIT packet to all the DHCP relay delegation and server with broadcast address as FF02::1:2.

2. Any DHCP server which receives the request, will reply the client with an ADVERTISE message, which includes the identity of the server –DUID, and its priority.
3. It is possible that the client receives multiple ADVERTISE messages. The client should select one and reply it with a REQUEST message to request the address which is advertised in the ADVERTISE message.
4. The selected DHCPv6 server then confirms the client about the IPv6 address and any other configuration with the REPLY message.

The above four steps finish a Dynamic host configuration assignment process. However, if the DHCPv6 server and the DHCPv6 client are not in the same network, the server will not receive the DHCPv6 broadcast packets sent by the client, therefore no DHCPv6 packets will be sent to the client by the server. In this case, a DHCPv6 relay is required to forward such DHCPv6 packets so that the DHCPv6 packets exchange can be completed between the DHCPv6 client and server.

At the time this manual is written, DHCPv6 server, relay and prefix delegation client have been implemented on the switch. When the DHCPv6 relay receives any messages from the DHCPv6 client, it will encapsulate the request in a Relay-forward packet and deliver it to the next DHCPv6 relay or the DHCPv6 server. The DHCPv6 messages coming from the server will be encapsulated as relay reply packets to the DHCPv6 relay. The relay then removes the encapsulation and delivers it the DHCPv6 client or the next DHCPv6 relay in the network.

For DHCPv6 prefix delegation where DHCPv6 server is configured on the PE router and DHCPv6 client it configured on the CPE router, the CPE router is able to send address prefix allocation request to the PE router and get a pre-configured address prefix, but not set the address prefix manually. The protocol negotiation between the client and the prefix delegation client is quite similar to that when getting a DHCPv6 address. Then the CPE router divides the allocated prefix – whose length should be less than 64 characters, into 64 subnets. The divided address prefix will be advertised through routing advertisement messages (RA) to the host directly connected to the client.

13.1.2 DHCPv6 Server Configuration

DHCPv6 server configuration task list as below:

1. To enable/disable DHCPv6 service
2. To configure DHCPv6 address pool
 - (1) To achieve/delete DHCPv6 address pool
 - (2) To configure parameter of DHCPv6 address pool
3. To enable DHCPv6 server function on port

1. To enable/disable DHCPv6 service

Command	Explanation
Global Mode	
service dhcpv6	To enable DHCPv6 service.

no service dhcpv6	
--------------------------	--

2. To configure DHCPv6 address pool

(1) To achieve/delete DHCPv6 address pool

Command	Explanation
Global Mode	
ipv6 dhcp pool <poolname> no ipv6 dhcp pool <poolname>	To configure DHCPv6 address pool.

(2) To configure parameter of DHCPv6 address pool

Command	Explanation
DHCPv6 address pool Configuration Mode	
network-address <ipv6-pool-start-address> {<ipv6-pool-end-address> <prefix-length>} [eui-64] no network-address	To configure the range of IPv6 address assignable of address pool.
dns-server <ipv6-address> no dns-server <ipv6-address>	To configure DNS server address for DHCPv6 client.
domain-name <domain-name> no domain-name <domain-name>	To configure DHCPv6 client domain name.
excluded-address <ipv6-address> no excluded-address <ipv6-address>	To exclude IPv6 address which isn't used for dynamic assignment in address pool.
lifetime {<valid-time> infinity} {<preferred-time> infinity} no lifetime	To configure valid time or preferred time of DHCPv6 address pool.

3. To enable DHCPv6 server function on port.

Command	Explanation
Interface Configuration Mode	
ipv6 dhcp server <poolname> [preference <value>] [rapid-commit] [allow-hint] no ipv6 dhcp server <poolname>	To enable DHCPv6 server function on specified port, and binding the used DHCPv6 address pool.

13.1.3 DHCPv6 Relay Delegation Configuration

DHCPv6 relay delegation configuration task list as below:

- To enable/disable DHCPv6 service
- To configure DHCPv6 relay delegation on port

1. To enable DHCPv6 service

Command	Explanation
---------	-------------

Global Mode	
service dhcpv6 no service dhcpv6	To enableDHCPv6 service.

2. To configure DHCPv6 relay delegation on port

Command	Explanation
Interface Configuration Mode	
ipv6 dhcp relay destination {[<ipv6-address>] [interface { <interface-name> vlan <1-4096>}]} no ipv6 dhcp relay destination {[<ipv6-address>] [interface { <interface-name> vlan <1-4096>}]}	To specify the destination address of DHCPv6 relay transmit; The no form of this command delete the configuration.

13.1.4 DHCPv6 Prefix Delegation Server Configuration

DHCPv6 prefix delegation server configuration task list as below:

- To enable/delete DHCPv6 service
- To configure prefix delegation pool
- To configure DHCPv6 address pool
 - To achieve/delete DHCPv6 address pool
 - To configure prefix delegation pool used by DHCPv6 address pool
 - To configure static prefix delegation binding
 - To configure other parameters of DHCPv6 address pool
- To enable DHCPv6 prefix delegation server function on port

1. To enable/delete DHCPv6 service

Command	Explanation
Global Mode	
service dhcpv6 no service dhcpv6	To enable DHCPv6 service.

2. To configure prefix delegation pool

Command	Explanation
Global Mode	
ipv6 local pool <poolname> <prefix prefix-length> <assigned-length> no ipv6 local pool <poolname>	To configure prefix delegation pool.

3. To configure DHCPv6 address pool

- To achieve/delete DHCPv6 address pool

Command	Explanation
Global Mode	

ipv6 dhcp pool <poolname> no ipv6 dhcp pool <poolname>	To configure DHCPv6 address pool.
---	-----------------------------------

(2) To configure prefix delegation pool used by DHCPv6 address pool

Command	Explanation
DHCPv6 address pool Configuration Mode	
prefix-delegation pool <poolname> /lifetime {<valid-time> infinity} {<preferred-time> infinity} no prefix-delegation pool <poolname>	To specify prefix delegation pool used by DHCPv6 address pool, and assign usable prefix to client.

(3) To configure static prefix delegation binding

Command	Explanation
DHCPv6 address pool Configuration Mode	
prefix-delegation <ipv6-prefix/prefix-length> <client-DUID> [iaid <iaid>] [lifetime {<valid-time> infinity} {<preferred-time> infinity}] no prefix-delegation <ipv6-prefix/prefix-length> <client-DUID> [iaid <iaid>]	To specify IPv6 prefix and any prefix required static binding by client.

(4) To configure other parameter of DHCPv6 address pool

Command	Explanation
DHCPv6 address pool Configuration Mode	
dns-server <ipv6-address> no dns-server <ipv6-address>	To configure DNS server address for DHCPv6 client.
domain-name <domain-name> no domain-name <domain-name>	To configure domain name for DHCPv6 client.

4. To enable DHCPv6 prefix delegation server function on port

Command	Explanation
Interface Configuration Mode	
ipv6 dhcp server <poolname> [preference <value>] [rapid-commit] [allow-hint] no ipv6 dhcp server <poolname>	To enable DHCPv6 server function on specified port, and binding used DHCPv6 address pool.

13.1.5 DHCPv6 Prefix Delegation Client Configuration

DHCPv6 prefix delegation client configuration task list as below:

- To enable/disable DHCPv6 service
- To enable DHCPv6 prefix delegation client function on port

1. To enable/disable DHCPv6 service

Command	Explanation
---------	-------------

Global Mode	
service dhcpv6 no service dhcpv6	To enable DHCPv6 service.

2. To enable DHCPv6 prefix delegation client function on port

Command	Explanation
Interface Configuration Mode	
ipv6 dhcp client pd <prefix-name> [rapid-commit] no ipv6 dhcp client pd	To enable client prefix delegation request function on specified port, and the prefix obtained associate with universal prefix configured.

13.1.6 DHCPv6 Configuration Examples

Example1:

When deploying IPv6 networking, the switch can be configured as DHCPv6 server in order to manage the allocation of IPv6 addresses. Both the state and the stateless DHCPv6 are supported.

Topology:

The access layer use Switch1 switch to connect users of dormitory buildings; Switch2 is configured as DHCPv6 relay delegation in primary aggregation layer ; Switch3 is configured as DHCPv6 server in secondary aggregation layer, and connected with backbone network or higher aggregation layers; The Windows Vista which be provided with DHCPv6 client must load on PC.

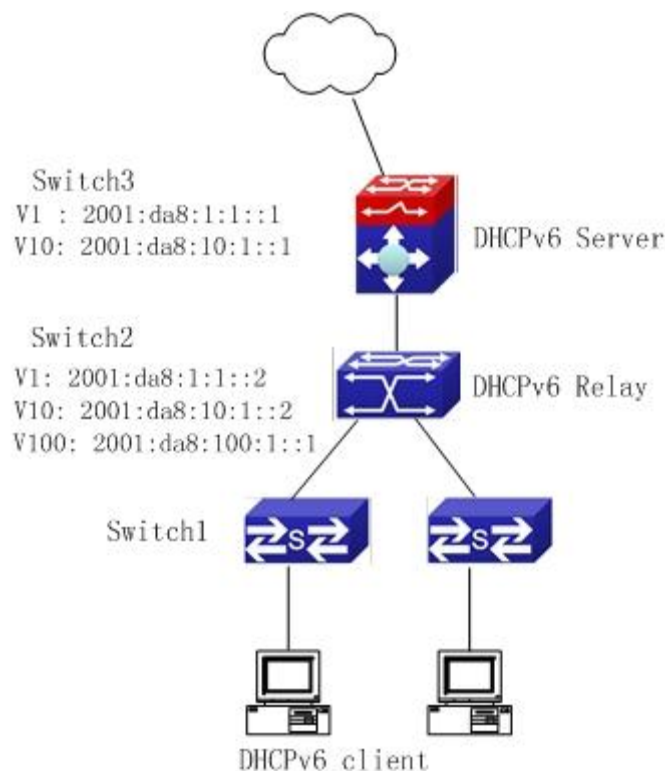

Usage guide:

Switch3 configuration:

```
Switch3>enable
Switch3#config
Switch3(config)#service dhcpv6
Switch3(config)#ipv6 dhcp pool EastDormPool
Switch3(dhcpv6-EastDormPool-config)#network-address 2001:da8:100:1::1 2001:da8:100:1::100
Switch3(dhcpv6-EastDormPool-config)#excluded-address 2001:da8:100:1::1
Switch3(dhcpv6-EastDormPool-config)#dns-server 2001:da8::20
Switch3(dhcpv6-EastDormPool-config)#dns-server 2001:da8::21
Switch3(dhcpv6-EastDormPool-config)#domain-name dhcpv6.com
Switch3(dhcpv6-EastDormPool-config)#lifetime 1000 600
Switch3(dhcpv6-EastDormPool-config)#exit
Switch3(config)#interface vlan 1
Switch3(Config-if-Vlan1)#ipv6 address 2001:da8:1:1::1/64
Switch3(Config-if-Vlan1)#exit
Switch3(config)#interface vlan 10
Switch3(Config-if-Vlan10)#ipv6 address 2001:da8:10:1::1/64
Switch3(Config-if-Vlan10)#ipv6 dhcp server EastDormPool preference 80
Switch3(Config-if-Vlan10)#exit
Switch3(config)#
```

Switch2 configuration:

```
Switch2>enable
Switch2#config
Switch2(config)#service dhcpv6
Switch2(config)#interface vlan 1
Switch2(Config-if-Vlan1)#ipv6 address 2001:da8:1:1::2/64
Switch2(Config-if-Vlan1)#exit
Switch2(config)#interface vlan 10
Switch2(Config-if-Vlan10)#ipv6 address 2001:da8:10:1::2/64
Switch2(Config-if-Vlan10)#exit
Switch2(config)#interface vlan 100
Switch2(Config-if-Vlan100)#ipv6 address 2001:da8:100:1::1/64
Switch2(Config-if-Vlan100)#no ipv6 nd suppress-ra
Switch2(Config-if-Vlan100)#ipv6 nd managed-config-flag
Switch2(Config-if-Vlan100)#ipv6 nd other-config-flag
Switch2(Config-if-Vlan100)#ipv6 dhcp relay destination 2001:da8:10:1::1
Switch2(Config-if-Vlan100)#exit
Switch2(config)#
```

Example2:

When the network operator is deploying IPv6 networks, network automatically configuration can be achieved through the prefix delegation allocation of IPv6 addresses, in stead of configuring manually for each switch:

1. To configure the switching or routing device which is connected to the client switch as

DHCPv6 prefix delegation server, that is to setup a local database for the relationship between the allocated prefix and the DUID of the client switch.

2. To configure the switch as the prefix delegation client, and make the client switch to get IPv6 address prefix from the prefix delegation server, through a process which is much like the process of DHCPv6 address allocation.
3. The edge devices which receive the address prefix, send routing advertisement - RA messages, to the client hosts about the address prefix through the interface which is connected to the hosts, then the hosts get an valid IPv6 address through stateless auto configuration, while at the same time, the stateless DHCPv6 server will be configured for the interface, in order to provide the DHCPv6 client with information such as DNS, and domain name, etc.

Network Topology:

The edge switch is a Switch1 switch. The interface connected to the trunk switch which is Switch2, is configured as the prefix delegation client. The interfaces connected to hosts, are configured as stateless DHCPv6 servers to provide the hosts with stateless information such as DNS and domain names, also routing advertisement of stateless address allocation is enabled for the host interfaces; On Switch2, the prefix delegation server is configured, and routing advertisement of state address allocation is enabled; On the host side, DHCPv6 client capable operating system such Windows Vista should be installed.

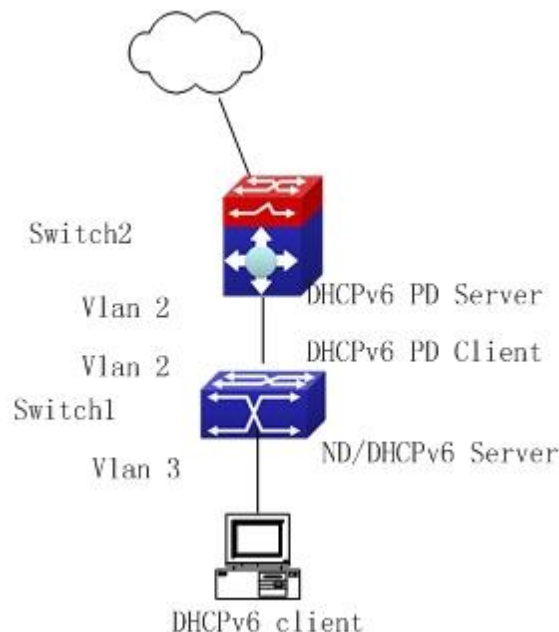

Usage guide:

Switch2 configuration

```
Switch2>enable
```

```
Switch2#config
```

```
Switch2(config)#interface vlan 2
```

```
Switch2(Config-if-Vlan2)#ipv6 address 2001:da8:1100::1/64
```

```
Switch2(Config-if-Vlan2)#exit
```

```
Switch2(config)#service dhcpv6
```

```
Switch2(config)#ipv6 local pool client-prefix-pool 2001:da8:1800::/40 48
Switch2(config)#ipv6 dhcp pool dhcp-pool
Switch2(dhcpv6-dhcp-pool-config)#prefix-delegation pool client-prefix-pool 1800 600
Switch2(dhcpv6-dhcp-pool-config)#exit
Switch2(config)#interface vlan 2
Switch2(Config-if-Vlan2)#ipv6 dhcp server dhcp-pool
Switch2(Config-if-Vlan2)#exit
```

Switch1 configuration

```
Switch1>enable
Switch1#config
Switch1(config)#service dhcpv6
Switch1(config)#interface vlan 2
Switch1(Config-if-Vlan2)#ipv6 dhcp client pd prefix-from-provider
Switch1(Config-if-Vlan2)#exit
Switch1(config)#interface vlan 3
Switch1(Config-if-Vlan3)#ipv6 address prefix-from-provider 0:0:0:1::1/64
Switch1(Config-if-Vlan3)#exit
Switch1(config)#ipv6 dhcp pool foo
Switch1(dhcpv6-foo-config)#dns-server 2001:4::1
Switch1(dhcpv6-foo-config)#domain-name www.ipv6.org
Switch1(dhcpv6-foo-config)#exit
Switch1(config)#interface vlan 3
Switch1(Config-if-Vlan3)#ipv6 dhcp server foo
Switch1(Config-if-Vlan3)#ipv6 nd other-config-flag
Switch1(Config-if-Vlan3)#no ipv6 nd suppress-ra
Switch1(Config-if-Vlan3)#exit
```

13.1.7 DHCPv6 Troubleshooting

If the DHCPv6 clients cannot obtain IPv6 addresses and other network parameters, the following procedures can be followed when DHCPv6 client hardware and cables have been verified ok:

- ☞ Verify the DHCPv6 server is running, start the related DHCP v6 server function if not running;
- ☞ If the DHCPv6 clients and servers are not in the same physical network, verify the router responsible for DHCPv6 packet forwarding has DHCPv6 relay function. If DHCPv6 relay is not available for the intermediate router, it is recommended to replace the router or upgrade its software to one that has a DHCPv6 relay function;
- ☞ Sometimes hosts are connected to the DHCPv6 enabled switches, but can not get IPv6 addresses. In this situation, it should be checked first whether the ports which the hosts are connected to, are connected with the port which the DHCPv6 server is connected to. If

connected directly, it should be checked then whether the IPv6 address pool of the VLAN which the port belongs to, is in the same subnet with the address pool configure in the DHCPv6 server; If not connected directly, and any layer three DHCPv6 relay is configured between the hosts and the DHCPv6 server, it should be checked first whether an valid IPv6 address has been configured for the switch interface which the hosts are connected to. If not configured, configure an valid IPv6 address. If configured, it should be checked whether the configured IPv6 address is in the same subnet with the DHCPv6 server. If not, please add it to the address pool.

13.2 DHCPv6 option37, 38

13.2.1 Introduction to DHCPv6 option37, 38

DHCPv6 (Dynamic Host Configuration Protocol for IPv6) is designed for IPv6 address scheme and is used for assigning IPv6 prefixes, IPv6 addresses and other configuration parameters to hosts.

When DHCPv6 client wants to request address and configure parameter of DHCPv6 server from different link, it needs to communicate with server through DHCPv6 relay agent. DHCPv6 message received by relay agent node is reencapsulated to be relay-forward packets and they are forwarded to the server which sends the relay-reply packets to DHCPv6 relay agent node in different link, after that, relay agent node restores DHCPv6 message to DHCPv6 client to finish communication between client and server.

There are some problems when using DHCPv6 relay agent, for example: How to assign IP address in the fixed range to the specific users? How to avoid illegal DHCPv6 client to forge IP address exhaust attack triggered by MAC address fields of DHCPv6 packets? How to avoid illegal DHCPv6 client to trigger deny service attack through using MAC address of other legal clients? Therefore, IETF set rfc4649 and rfc4580, i.e. DHCPv6 option 37 and option 38 to solve these problems.

DHCPv6 option 37 and option 38 is similar to DHCP option 82. When DHCPv6 client sends request packets to DHCPv6 server though DHCPv6 relay agent, if DHCPv6 relay agent supports option 37 and option 38, they will be added to request packets. For the respond packets of server, option 37 and option 38 are meaningless and are peeled from the respond packets. Therefore, the application of option 37 and option 38 is transparent for client.

DHCPv6 server can authenticate identity of DHCPv6 client and DHCPv6 relay device by option 37 and option 38, assign and manage client address neatly through configuring the assign policy, prevent DHCPv6 attack availably according to the inclusive client information, such as forging MAC address fields of DHCPv6 packets to trigger IP address exhaust attack. Since server can identify multiple request packets from the same access port, it can assign the address number through policy limit to avoid address exhaust. However, rfc4649 and rfc4580 do not set how to use option 37 and option 38 for DHCPv6 server, users can use it neatly according to their own

demand.

13.2.2 DHCPv6 option37, 38 Configuration Task List

1. Dhcpv6 snooping option basic functions configuration
2. Dhcpv6 relay option basic functions configuration
3. Dhcpv6 server option basic functions configuration

1.DHCPv6 snooping option basic functions configuration

Command	Description
Global mode	
ipv6 dhcp snooping remote-id option no ipv6 dhcp snooping remote-id option	This command enables DHCPv6 SNOOPING to support option 37 option, no command disables it.
ipv6 dhcp snooping subscriber-id option no ipv6 dhcp snooping subscriber-id option	This command enables DHCPv6 SNOOPING to support option 38 option, no command disables it.
ipv6 dhcp snooping remote-id policy {drop keep replace} no ipv6 dhcp snooping remote-id policy	This command is used to configure the reforward policy of the system when receiving DHCPv6 packets with option 37, which can be: drop , the system simply discards it with option 37; keep , the system keeps option 37 unchanged and forwards the packet to the server; replace , the system replaces option 37 of current packet with its own before forwarding it to the server. no command configures the reforward policy of DHCPv6 packets with option 37 as replace.
ipv6 dhcp snooping subscriber-id policy {drop keep replace} no ipv6 dhcp snooping subscriber-id policy	This command is used to configure the reforward policy of the system when receiving DHCPv6 packets with option 38, which can be: drop , the system simply discards it with option 38; keep , the system keeps option

	<p>38 unchanged and forwards the packet to the server;</p> <p>replace, the system replaces option 38 of current packet with its own before forwarding it to the server. no command configures the reforward policy of DHCPv6 packets with option 38 as replace.</p>
<p>ipv6 dhcp snooping subscriber-id select (sp sv pv spv) delimiter WORD (delimiter WORD) no ipv6 dhcp snooping subscriber-id select delimiter</p>	<p>Configures user configuration options to generate subscriber-id, no command restores to its original default configuration, i.e. enterprise number together with vlan MAC.</p>
<p>ipv6 dhcp snooping subscriber-id select (sp sv pv spv) delimiter WORD (delimiter WORD) no ipv6 dhcp snooping subscriber-id select delimiter</p>	<p>Configures user configuration options to generate subscriber-id. The no command restores to its original default configuration, i.e. vlan name together with port name.</p>
Port mode	
<p>ipv6 dhcp snooping remote-id <remote-id> no ipv6 dhcp snooping remote-id</p>	<p>This command is used to set the form of adding option 37 in received DHCPv6 request packets, of which <remote-id> is the content of remote-id in user-defined option 37 and it is a string with a length of less than 128. The no operation restores remote-id in option 37 to enterprise-number together with vlan MAC address.</p>
<p>ipv6 dhcp snooping subscriber-id <subscriber-id> no ipv6 dhcp snooping subscriber-id</p>	<p>This command is used to set the form of adding option 38 in received DHCPv6 request packets, of which <subscriber-id> is the content of subscriber-id in user-defined option 38 and it is a string with a length of less than 128. The no operation restores subscriber-id in option 38 to</p>

	vlan name together with port name such as "Vlan2+Ethernet1/0/2".
--	--

2. DHCPv6 relay option basic functions configuration

Command	Description
Global mode	
ipv6 dhcp relay remote-id option no ipv6 dhcp relay remote-id option	This command enables the switch relay to support option 37 and the no form of this command disables it.
ipv6 dhcp relay subscriber-id option no ipv6 dhcp relay subscriber-id option	This command enables the switch relay to support the option 38, the no form of this command disables it.
ipv6 dhcp relay remote-id delimiter WORD no ipv6 dhcp relay remote-id delimiter	Configures user configuration options to generate remote-id. The no command restores to its original default configuration, i.e. enterprise number together with vlan MAC.
ipv6 dhcp relay subscriber-id select (sp sv pv spv) delimiter WORD (delimiter WORD) no ipv6 dhcp relay subscriber-id select delimiter	Configures user configuration options to generate subscriber-id. The no command restores to its original default configuration, i.e. vlan name together with port name.
Layer3 Interface configuration mode	
ipv6 dhcp relay remote-id <remote-id> no ipv6 dhcp relay remote-id	This command is used to set the form of adding option 37 in received DHCPv6 request packets, of which <remote-id> is the content of remote-id in user-defined option 37 and it is a string with a length of less than 128. The no operation restores remote-id in option 37 to enterprise-number together with vlan MAC address.
ipv6 dhcp relay subscriber-id <subscriber-id> no ipv6 dhcp relay subscriber-id	This command is used to set the form of adding option 38 in received DHCPv6 request packets, of which <subscriber-id> is the content of

	subscriber-id in user-defined option 38 and it is a string with a length of less than 128. The no operation restores subscriber-id in option 38 to vlan name together with port name such as "Vlan2+Ethernet1/0/2".
--	---

3. Dhcpv6 server option basic functions configuration

Command	Description
Global mode	
ipv6 dhcp server remote-id option no ipv6 dhcp server remote-id option	This command enables DHCPv6 server to support the identification of option 37, the no form of this command disables it.
ipv6 dhcp server subscriber-id option no ipv6 dhcp server subscriber-id option	This command enables DHCPv6 server to support the identification of option 38, the no form of this command disables it.
ipv6 dhcp use class no ipv6 dhcp use class	This command enables DHCPv6 server to support the using of DHCPv6 class during address assignment, the no form of this command disables it without removing the relative DHCPv6 class information that has been configured.
ipv6 dhcp class <class-name> no ipv6 dhcp class <class-name>	This command defines a DHCPv6 class and enters DHCPv6 class mode, the no form of this command removes this DHCPv6 class.
Interface configuration mode	
ipv6 dhcp server select relay-forw no ipv6 dhcp server select relay-forw	This command enables the DHCPv6 server to support selections when multiple option 37 or option 38 options exist and the option 37 and option 38 of relay-forw in the innermost layer are selected. The no operation of it restores the

	default configuration, i.e. selecting option 37 and option 38 of the original packets.
IPv6 DHCP Class configuration mode	
{remote-id [*] <remote-id> [*] subscriber-id [*] <subscriber-id> [*]} no {remote-id [*] <remote-id> [*] subscriber-id [*] <subscriber-id> [*]}	This command configures option 37 and option 38 that match the class in ipv6 dhcp class configuration mode.
DHCPv6 address pool configuration mode	
class <class-name> no class <class-name>	This command associates class to address pool in DHCPv6 address pool configuration mode and enters class configuration mode in address pool. Use no command to remove the link.
address range <start-ip> <end-ip> no address range <start-ip> <end-ip>	This command is used to set address range for a DHCPv6 class in DHCPv6 address pool configuration mode, the no command is used to remove the address range. The prefix/plen form is not supported.

13.2.3 DHCPv6 option37, 38 Examples

13.2.3.1 DHCPv6 Snooping option37, 38 Example

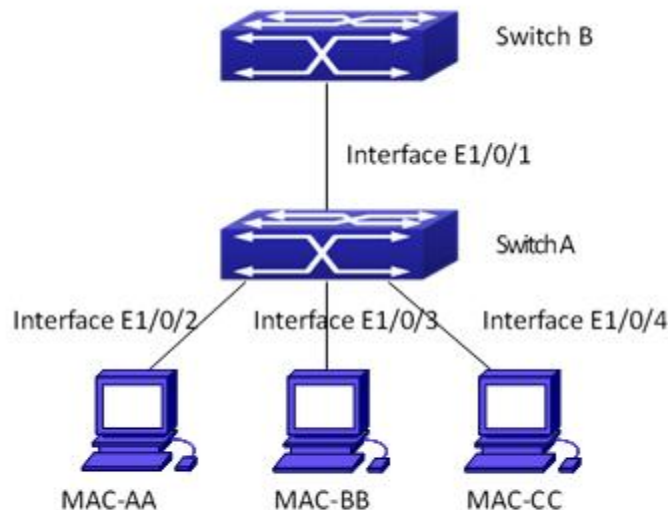

Figure 14-2 DHCPv6 Snooping option schematic

As is shown in the figure above, Mac-AA, Mac-BB and Mac-CC are normal users, connected to untrusted interface 1/0/2, 1/0/3 and 1/0/4 respectively, and they get IP 2010:2, 2010:3 and 2010:4 through DHCPv6 Client; DHCPv6 Server is connected to the trusted interface 1/0/1. Configure three address assignment policies (CLASS), of which CLASS1 matches option 38, CLASS2 matches option 37 and CLASS3 matches option 37 and option 38. In the address pool EastDormPool, the requests matched with CLASS1, CLASS2 and CLASS3 will be assigned an address ranging from 2001:da8:100:1::2 to 2001:da8:100:1::30, from 2001:da8:100:1::31 to 2001:da8:100:1::60 and from 2001:da8:100:1::61 to 2001:da8:100:1::100 respectively; DHCPv6 snooping function is enabled and option 37 and option 38 are configured in Switch A.

Switch A configuration:

```
SwitchA(config)#ipv6 dhcp snooping remote-id option
SwitchA(config)#ipv6 dhcp snooping subscriber-id option
SwitchA(config)#int e 1/0/1
SwitchA(config-if-ethernet1/0/1)#ipv6 dhcp snooping trust
SwitchA(config-if-ethernet1/0/1)#exit
SwitchA(config)#interface vlan 1

SwitchA(config-if-vlan1)#ipv6 address 2001:da8:100:1::1
SwitchA(config-if-vlan1)#exit
SwitchA(config)#interface ethernet 1/0/1-4
SwitchA(config-if-port-range)#switchport access vlan 1
SwitchA(config-if-port-range)#exit
SwitchA(config)#
```

Switch B configuration:

```
SwitchB(config)#service dhcpv6
SwitchB(config)#ipv6 dhcp server remote-id option
```

```
SwitchB(config)#ipv6 dhcp server subscriber-id option
SwitchB(config)#ipv6 dhcp pool EastDormPool
SwitchB(dhcpv6-eastdormpool-config)#network-address 2001:da8:100:1::2 2001:da8:100:1::1000
SwitchB(dhcpv6-eastdormpool-config)#dns-server 2001::1
SwitchB(dhcpv6-eastdormpool-config)#domain-name dhcpv6.com
SwitchB(dhcpv6-eastdormpool-config)# excluded-address 2001:da8:100:1::2
SwitchB(dhcpv6-eastdormpool-config)#exit
SwitchB(config)#
SwitchB(config)#ipv6 dhcp class CLASS1
SwitchB(dhcpv6-class-class1-config)#remote-id 00-03-0f-00-00-01 subscriber-id
vlan1+Ethernet1/0/1
SwitchB(dhcpv6-class-class1-config)#exit
SwitchB(config)#ipv6 dhcp class CLASS2
SwitchB(dhcpv6-class-class2-config)#remote-id 00-03-0f-00-00-01 subscriber-id
vlan1+Ethernet1/0/2
SwitchB(dhcpv6-class-class2-config)#exit
SwitchB(config)#ipv6 dhcp class CLASS3
SwitchB(dhcpv6-class-class3-config)#remote-id 00-03-0f-00-00-01 subscriber-id
vlan1+Ethernet1/0/3
SwitchB(dhcpv6-class-class3-config)#exit
SwitchB(config)#ipv6 dhcp pool EastDormPool
SwitchB(dhcpv6-eastdormpool-config)#class CLASS1
SwitchB(dhcpv6-pool-eastdormpool-class-class1-config)#address range 2001:da8:100:1::3
2001:da8:100:1::30
SwitchB(dhcpv6-pool-eastdormpool-class-class1-config)#exit
SwitchB(dhcpv6-eastdormpool-config)#class CLASS2
SwitchB(dhcpv6-pool-eastdormpool-class-class2-config)#address range 2001:da8:100:1::31
2001:da8:100:1::60
SwitchB(dhcpv6-eastdormpool-config)#class CLASS3
SwitchB(dhcpv6-pool-eastdormpool-class-class3-config)#address range 2001:da8:100:1::61
2001:da8:100:1::100
SwitchB(dhcpv6-pool-eastdormpool-class-class3-config)#exit
SwitchB(dhcpv6-eastdormpool-config)#exit
SwitchB(config)#interface vlan 1
SwitchB(config-if-vlan1)#ipv6 address 2001:da8:100:1::2/64
SwitchB(config-if-vlan1)#ipv6 dhcp server EastDormPool
SwitchB(config-if-vlan1)#exit
SwitchB(config)#
```

13.2.3.2 DHCPv6 Relay option37, 38 Example

Example 1:

When deploying IPv6 campus network, DHCPv6 server function of routing device can be used for IPv6 address allocation if special server is used for uniform allocation and management

for IPv6 address. DHCPv6 server supports both stateful and stateless DHCPv6.

Network topology:

In access layer, layer2 access device Switch1 connects users in dormitory; in first-level aggregation layer, aggregation device Switch2 is used as DHCPv6 relay agent; in second-level aggregation layer, aggregation device Switch3 is used as DHCPv6 server and connects with backbone network or devices in higher aggregation layer; in user side, PCs are generally loaded with Windows Vista system, thus having DHCPv6 client.

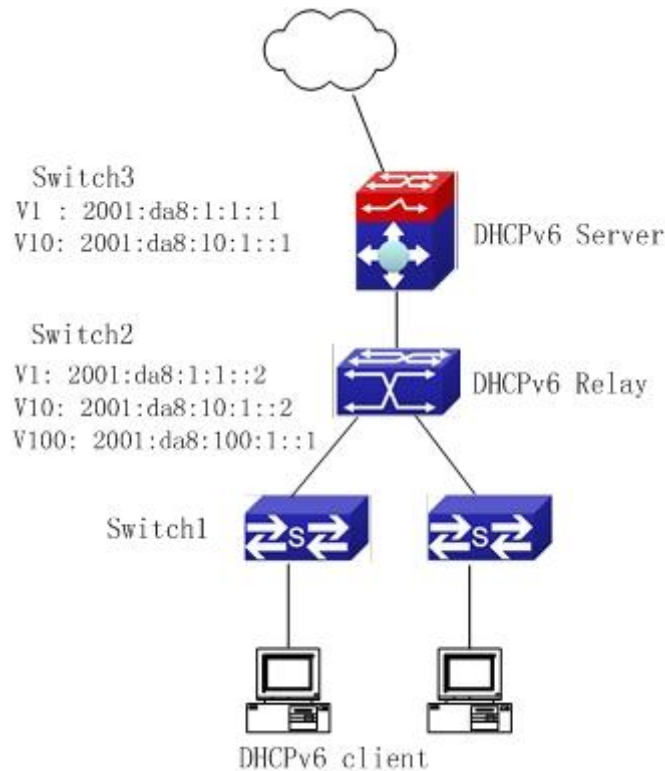

Figure 14-3 DHCPv6 relay option schematic

Switch2 configuration:

```
S2(config)#service dhcpv6
S2(config)#ipv6 dhcp relay remote-id option
S2(config)#ipv6 dhcp relay subscriber-id option
S2(config)#vlan 10
S2(config-vlan10)#int vlan 10
S2(config-if-vlan10)#ipv6 address 2001:da8:1::2/64
S2(config-if-vlan10)#ipv6 dhcp relay destination 2001:da8:10:1::1
S2(config-if-vlan10)#exit
S2(config)#
```

13.2.4 DHCPv6 option37, 38 Troubleshooting

- Request packets sent by DHCPv6 client are multicast packets received by the device within its VLAN, if DHCPv6 server wants to receive the packets from client, DHCPv6 client and DHCPv6 server must be in the same VLAN, otherwise it needs to use DHCPv6 relay.

- ✎ Snooping option37,38 can process one of the following operations for DHCPv6 request packets with option37,38: replace the original option37,38 with its own; discard the packets with option37,38; do not execute adding, discarding or forwarding operation. Therefore, please check policy configuration of snooping option37,38 on second device when obtaining the false address or no address is obtained according to option37,38.
- ✎ DHCPv6 server obtains option37,38 of the packets from client by default, if no, it will obtain option37,38 of the packet sent by relay.
- ✎ DHCPv6 server only checks whether the first DHCPv6 relay adds option37,38 that means only option37,38 of the innermost relay-forw is valid in relay packets.

13.3 Prevent ND Spoofing

13.3.1 Overview

ND is neighbor discovering protocol in IPv6 protocol, and it's similar to ARP on operation principle, therefore we do in the same way as preventing ARP spoofing to prevent ND spoofing and attack.

13.3.2 Prevent ND Spoofing configuration

The steps of preventing ND spoofing configuration as below:

4. Disable ND automatic update function
5. Disable ND automatic learning function
6. Changing dynamic ND to static ND

1. Disable ND automatic update function

Command	Explanation
Global Mode and Port Mode	
ipv6 nd-security updateprotect no ipv6 nd-security updateprotect	Disable and enable ND automatic update function.

2. Disable ND automatic learning function

Command	Explanation
Global mode and Interface Mode	

ipv6 nd-security learnprotect	Disable and enable ND automatic learning function.
no ipv6 nd-security learnprotect	

3. Function on changing dynamic ND to static ND

Command	Explanation
Global Mode and Port Mode	
ipv6 nd-security convert	Change dynamic ND to static ND.

13.3.3 Prevent ND Spoofing Example

Please refer to the Arp binding example

13.4 RIPng

13.4.1 Introduction to RIPng

RIPng is first introduced in ARPANET, this is a protocol dedicated to small, simple networks. RIPng is a distance vector routing protocol based on the Bellman-Ford algorithm. Network devices running vector routing protocol send 2 kind of information to the neighboring devices regularly:

- Number of hops to reach the destination network, or metrics to use or number of networks to pass.
- What is the next hop, or the director (vector) to use to reach the destination network.

Distance vector layer3 switches send all their route selecting tables to the neighbor layer3 switches at regular interval. A layer3 switch will build their own route selecting information table based on the information received from the neighbor layer3 switches. Then, it will send this information to its own neighbor layer3 switches. As a result, the route selection table is built on second hand information, route beyond 15 hops will be deemed as unreachable.

RIPng is an optional routing protocol based on UDP. Hosts using RIPng send and receive packets on UDP port 521. All layer3 switches running RIP send their route table to all neighbor layer3 switches every 30 seconds for update. If no information from the partner is received in 180 seconds, then the device is deemed to have failed and the network connected to that device is considered to be unreachable. However, the route of that layer3 switch will be kept in the route table for another 120 seconds before deletion.

As layer3 switches running RIPng build route table with second hand information, infinite count may occur. For a network running RIPng routing protocol, when a RIPng route becomes unreachable, the neighboring RIPng layer3 switch will not send route update packets at once, instead, it waits until the update interval timeout (every 30 seconds) and sends the update packets containing that route. If before it receives the updated packet, its neighbors send packets containing the information about the failed neighbor, “infinite count” will be resulted. In other words, the route of unreachable layer3 switch will be selected with the metrics increasing

progressively. This greatly affects the route selection and route aggregation time.

To avoid “infinite count”, RIPng provides mechanism such as “split horizon” and “triggered update” to solve route loop. “Split horizon” is done by avoiding sending to a gateway routes learned from that gateway. There are two split horizon methods: “simple split horizon” and “poison reverse split horizon”. Simple split horizon deletes from the route to be sent to the neighbor gateways the routes learnt from the neighbor gateways; poison reverse split horizon not only deletes the abovementioned routes, but set the costs of those routes to infinite. “Triggering update” mechanism defines whenever route metric changed by the gateway, the gateway advertise the update packets immediately other than wait for the 30 sec timer.

So far the RIPng protocol has got only one version---Version1: RIPng protocol is introduced in RFC 2080. RIPng transmits updating data packet by multicast data packet (multicast address FF02::9)

Each layer3 switch running RIPng has a route database, which contains all route entries for reachable destination, and route table is built based on this database. When a RIPng layer3 switch sent route update packets to its neighbor devices, the complete route table is included in the packets. Therefore, in a large network, routing data to be transferred and processed for each layer3 switch is quite large, causing degraded network performance.

Besides the above mentioned, RIPng protocol allows IPv6 route information discovered by the other routing protocols to be introduced to the route table.

The operation of RIPng protocol is shown below:

1. Enable RIPng The switch sends request packets to the neighbor layer3 switches by broadcasting; on receiving the request, the neighbor devices reply with the packets containing their local routing information.
2. The Layer3 switch modifies its local route table on receiving the reply packets and sends triggered update packets to the neighbor devices to advertise route update information. On receiving the triggered update packet, the neighbor lay3 switches send triggered update packets to their neighbor lay3 switches. After a sequence of triggered update packet broadcast, all layer3 switches get and maintain the latest route information.

In addition, RIPng layer3 switches will advertise its local route table to their neighbor devices every 30 seconds. On receiving the packets, neighbor devices maintain their local route table, select the best route and advertise the updated information to their own neighbor devices, so that the updated routes are globally valid. Moreover, RIP uses a timeout mechanism for outdated route, that is, if a switch does not receive regular update packets from a neighbor within a certain interval (invalid timer interval), it considers the route from that neighbor invalid, after holding the route for a certain interval (garbage collect timer interval), it will delete that route.

As a result of continuous development of IPv6 network, it has the network environment of nonsupport IPv6 sometimes, so it needs to do the IPv6 operation by tunnel. Therefore, our RIPng supports configuration on configure tunnel, and passes through nonsupport IPv6 network by unicast packet of IPv4 encapsulation.

13.4.2 RIPng Configuration Task List

RIPng Configuration Task List:

1. Enable RIPng protocol (required)
 - (1) Enable/disable RIPng protocol
 - (2) Configure the interfaces running RIPng protocol
2. Configure RIPng protocol parameters (optional)
 - (1) Configure RIPng sending mechanism
 - 1) Configure specified RIPng packets transmission address
 - (2) Configure RIP routing parameters
 - 1) Configure route introduction (default route metric, configure routes of the other protocols to be introduced in RIPng)
 - 2) Configure the route deviation
 - 3) Configure and apply route filter
 - 4) Configure split horizon
3. Configure other RIPng parameters
 - (2) Configure timer for RIPng update, timeout and hold-down
4. Delete the specified route in RIPng route table
5. Configure RIPng route aggregation
 - (1) Configure aggregation route of IPv6 route mode
 - (2) Configure aggregation route of IPv6 interface configuration mode
 - (3) Display IPv6 aggregation route information
6. Configure redistribution of OSPFv3 routing to RIPng
 - (1) Enable redistribution of OSPFv3 routing to RIPng
 - (2) Display and debug the information about configuration of redistribution of OSPFv3 routing to RIPng

1. Enable RIPng protocol

Applying RIPng route protocol with basic configuration in switch is simple. Normally you only have to open the RIPng switch and configure the segments running RIPng, namely send and receive the RIPng data packet by default RIPng configuration.

Command	Explanation
Global mode	
[no] router IPv6 rip	Enables the RIPng protocol; the no router IPv6 rip command shuts the RIPng protocol.
Interface configuration mode	
[no] IPv6 router rip	Configure the interface to run RIPng protocol; the no IPv6 router rip command set the interface not run RIPng protocol.

2. Configure RIPng protocol parameters

(1) Configure RIPng sending mechanism

- 1) Configure the RIPng data packets point-transmitting

Command	Explanation
Router configuration mode	
[no] neighbor <IPv6-address> <ifname>	Specify the IPv6 Link-local address and interface of the neighboring route needs point-transmitting; the no neighbor <IPv6-address> <ifname> command cancels the appointed router.
[no] passive-interface <ifname>	Block the RIPng multicast on specified port and the RIPng data packet is only transmittable among Layer 3 switch configured with neighbor. The no passive-interface <ifname> command cancels the function.

(2) Configure RIP routing parameters

1) Configure route introduction (default route metric, configure routes of the other protocols to be introduced in RIP)

Command	Explanation
Router configuration mode	
default-metric <value> no default-metric	Configure the default metric of distributed route; the no default-metric command restores the default configuration 1.
[no] redistribute {kernel connected static ospf isis bgp} [metric<value>] [route-map<word>]	Redistribute the routes distributed in other route protocols into the RIPng data packet; the no redistribute {kernel connected static ospf isis bgp} [metric<value>] [route-map<word>] command cancels the distributed route of corresponding protocols.
[no] default-information originate	Generate a default route to the RIPng protocol; the no default-information originate command cancels the feature.

2) Configure the route offset

Command	Explanation
Router configuration mode	
[no] offset-list <access-list-number access-list-name> {in out} <number > [<ifname>]	Configure that provide a deviation value to the route metric value when the port sends or receives RIPng data packet; the no offset-list <access-list-number access-list-name> {in out} <number > [<ifname>] command removes the deviation table.

3) Configure and apply route filter and route aggregation

Command	Explanation
Router configuration mode	
[no] distribute-list {<access-list-number access-list-name> 	Set to filter the route when the interface sends and receives RIPng data packets. The no

prefix <prefix-list-name> {in out} [<i>ifname</i>]	distribute-list {< access-list-number access-list-name > prefix <prefix-list-name>} {in out} [<i>ifname</i>] command means do not set the route filter.
[no]aggregate-address <IPv6-address>	Configure route aggregation, the no aggregate-address <IPv6-address> command cancels the route aggregation.

4) Configure split horizon

Command	Explanation
Interface configuration mode	
IPv6 rip split-horizon [poisoned]	Configure that take the split-horizon when the port sends data packets, poisoned means with poison reverse.
no IPv6 rip split-horizon	Cancel the split-horizon.

3. Configure other RIPng protocol parameters

(1) Configure timer for RIPng update, timeout and hold-down

Command	Explanation
Router configuration mode	
timers basic <update> <invalid> <garbage> no timers basic	Adjust update, timeout and garbage recycle of RIPng timer, the no timers basic command restores the default configuration.

4. Delete the specified route in RIPng route table

Command	Explanation
Admin Mode	
clear IPv6 rip route {<IPv6-address> kernel static connected rip ospf isis bgp all}	The command deletes a specified route from the RIP route table.

5. Configure RIPng route aggregation

(1) Configure IPv6 aggregation route globally

Command	Explanation
Router Configuration Mode	
ipv6 rip aggregate-address X:X::X:X/M no ipv6 rip aggregate-address X:X::X:X/M	To configure or delete IPv6 aggregation route globally.

(2) Configure IPv6 aggregation route on interface

Command	Explanation
Interface Configuration Mode	

ipv6 rip aggregate-address X:X::X:X/M	To configure or delete IPv6 aggregation route on interface.
no ipv6 rip aggregate-address X:X::X:X/M	

(3) Display IPv6 aggregation route information

Command	Explanation
Admin Mode and Configuration Mode	
show ipv6 rip aggregate	To display IPv6 aggregation route information, such as aggregation interface, metric, numbers of aggregation route, times of aggregation.

6. Configure redistribution of OSPFv3 routing to RIPng**(1) Enable redistribution of OSPFv3 routing to RIPng**

Command	Explanation
Router IPv6 RIP Configuration Mode	
redistribute ospf [<process-tag>] [metric<value>] [route-map<word>] no redistribute ospf [<process-tag>]	To enable or disable redistribution of OSPFv3 routing for RIPng.

(2) Display and debug the information about configuration of redistribution of OSPFv3 routing to RIPng

Command	Explanation
Admin Configuration Mode	
show ipv6 rip redistribute	To display RIPng routing which is redistributed from other routing protocols.
Admin Mode	
debug ipv6 rip redistribute message send no debug ipv6 rip redistribute message send debug ipv6 rip redistribute route receive no debug ipv6 rip redistribute route receive	To enable or disable debugging messages sent by RIPng for redistribution of OSPFv3 routing. To enable or disable debugging route messages received from NSM.

13.4.3 RIPng Configuration Examples**13.4.3.1 Typical RIPng Examples**

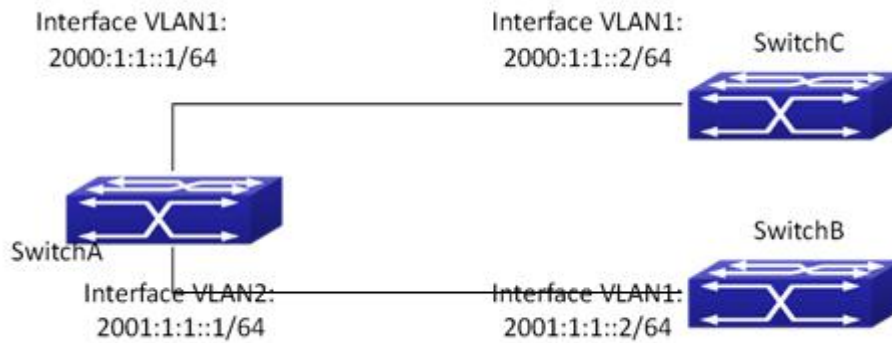

Figure 14-4 RIPng Example

As shown in the above figure, a network consists of three layer 3 switches. SwitchA and SwitchB connect to SwitchC through interface vln1 and vln2. All the three switches are running RIPng. Assume SwitchA (VLAN1: 2001:1:1::1/64 and VLAN2: 2001:1:1::1/64) exchange update information with SwitchB (VLAN1: 2001:1:1::2/64) only, update information is not exchanged between SwitchA and SwitchC (VLAN1: 2001:1:1::2/64).

The configuration for SwitchA, SwitchB and SwitchC is shown below:

Layer 3 SwitchA

Enable RIPng protocol

```
SwitchA(config)#router IPv6 rip
```

```
SwitchA(config-router)#exit
```

Configure the IPv6 address in vln1 and configure vln1 to run RIPng

```
SwitchA#config
```

```
SwitchA(config)# interface Vln1
```

```
SwitchA(config-if-Vln1)# IPv6 address 2000:1:1::1/64
```

```
SwitchA(config-if-Vln1)#IPv6 router rip
```

```
SwitchA(config-if-Vln1)#exit
```

Configure the IPv6 address in vln2 and configure vln2 to run RIPng

```
SwitchA(config)# interface Vln2
```

```
SwitchA(config-if-Vln2)#IPv6 address 2001:1:1::1/64
```

```
SwitchA(config-if-Vln2)#IPv6 router rip
```

```
SwitchA(config-if-Vln2)#exit
```

Configure the interface vln1 do not send RIPng messages to SwitchC

```
SwitchA(config)#
```

```
SwitchA(config-router)#passive-interface Vln1
```

```
SwitchA(config-router)#exit
```

Layer 3 SwitchB

Enable RIPng protocol

```
SwitchB (config)#router IPv6 rip
```

```
SwitchB (config-router-rip)#exit
```

Configure the IPv6 address and interfaces of Ethernet port vln1 to run RIPng

```
SwitchB#config
```

```
SwitchB(config)# interface Vln1
```

```
SwitchB(config-if)# IPv6 address 2001:1:1::2/64
SwitchB(config-if)#IPv6 router rip
SwitchB(config-if)#exit
```

Layer 3 SwitchC

Enable RIPng protocol

```
SwitchC(config)#router IPv6 rip
```

```
SwitchC(config-router-rip)#exit
```

Configure the IPv6 address and interfaces of Ethernet port vlan1 to run RIPng

```
SwitchC#config
```

```
SwitchC(config)# interface Vlan1
```

```
SwitchC(config-if)# IPv6 address 2000:1:1::2/64
```

```
SwitchC(config-if)#IPv6 router rip
```

```
SwitchC(config-if)#exit
```

13.4.3.2 RIPng Aggregation Route Function Typical Examples

The application topology as follows:

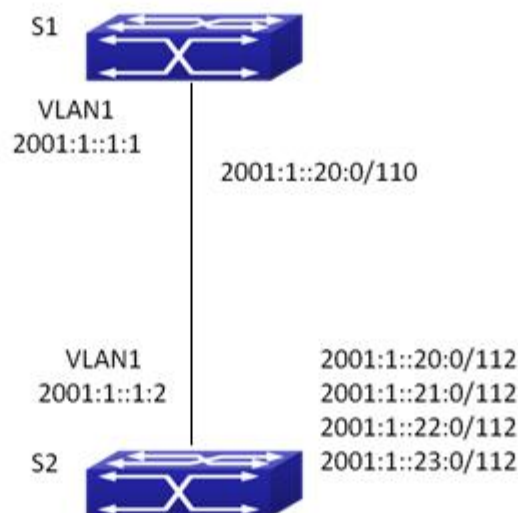

Figure 14-5 Typical application of RIPng aggregation

As the above network topology, S2 is connected to S1 through interface vlan1, there are other 4 subnet routers of S2, which are 2001:1::20:0/112, 2001:1::21:0/112, 2001:1::22:0/112, 2001:1::23:0/112. S2 supports route aggregation, and to configure aggregation route 2001:1::20:0/110 in interface vlan1 of S2, after that, sending router messages to S2 through vlan1, and put the four subnet routers aggregated to one router as 2001:1::20:0/110, and send to S1, and not send subnet to neighbor. It can reduce the router table of S1, save the memory.

S1 configuration list:

```
S1(config)#router ipv6 rip
```

```
S1(config)# interface Vlan1
```

```
S1(config-if-Vlan1)#IPv6 address 2001:1::1:1/112
```

```
S1(config-if-Vlan1)#IPv6 router rip
```

```
S2 configuration list:
S2(config)#router ipv6 rip
S2(config)#interface vlan 1
S2(config-if-Vlan1)#IPv6 address 2001:1::1:2/112
S2(config-if-Vlan1)#IPv6 router rip
S2(Config-if-Vlan1)#ipv6 rip agg 2001:1::20:0/110
```

13.4.4 RIPng Troubleshooting

The RIPng protocol may not be working properly due to errors such as physic connection, configuration error when configuring and using the RIPng protocol. So users should pay attention to the following:

- 👉 First ensure the physic connection is correct and the IP Forwarding command is open
- 👉 Second, ensure the interface and link layer protocol are UP (use **show interface** command)
- 👉 Then initiate the RIPng protocol (use **router IPv6 rip** command) and configure the port (use **IPv6 router** command), and set RIPng protocol parameter on corresponding interfaces.
- 👉 After that, a RIPng protocol feature should be noticed ---the Layer 3 switch running RIPng transmits the route updating messages every 30 seconds. A Layer 3 switch is considered inaccessible if no route updating messages from the switch are received within 180 seconds, then the route to the switch will remains in the route table for 120 seconds before it is deleted. Therefore, if to delete a RIPng route, this route item is assured to be deleted from route table after 300 seconds.
- 👉 If the RIP routing problem remains unresolved, please use **debug IPv6 rip** command to record the debug message in three minutes, and send them to our technical service center.

13.5 OSPFv3

13.5.1 Introduction to OSPFv3

OSPFv3 (Open Shortest Path First) is the third version for Open Shortest Path First, and it is the IPv6 version of OSPF Protocol. It is an interior dynamic routing protocol for autonomous system based on link-state. The protocol creates a link-state database by exchanging link-states among layer3 switches, and then uses the Shortest Path First algorithm to generate a route table basing on that database.

Autonomous system (AS) is a self-managed interconnected network. In large networks, such as the Internet, a giant interconnected network is broken down to autonomous systems. Big enterprise networks connecting to the Internet are independent AS, since the other hosts on the Internet are not managed by those AS and they don't share interior routing information with the

layer3 switches on the Internet.

Each link-state layer3 switch can provide information about the topology with its neighboring layer3 switches.

- The network segment (link) connecting to the layer3 switch
- State of the connecting link

Link-state information is flooded throughout the network so that all layer3 switches can get first hand information. Link-state layer3 switches will not broadcast all information contained in their route tables; instead, they only send changed link-state information. Link-state layer3 switches establish neighborhood by sending “HELLO” to their neighbors, then link-state advertisements (LSA) will be sent among neighboring layer3 switches. Neighboring layer3 switch copy the LSA to their routing table and transfer the information to the rest part of the network. This process is referred to as “flooding”. In this way, firsthand information is sent throughout the network to provide accurate map for creating and updating routes in the network. Link-state routing protocols use cost instead of hops to decide the route. Cost is assigned automatically or manually. According to the algorithm in link-state protocol, cost can be used to calculate the hop number for packets to pass, link bandwidth, and current load of the link, the administrator can even add weight for better assessment of the link-state.

1) When a link-state layer3 switch enters a link-state interconnected network, it sends a HELLO packet to get to know its neighbors and establish neighborhood.

2) The neighbors respond with information about the links they are connecting and the related costs.

3) The originate layer3 switch uses this information to build its own routing table.

4) Then, as part of the regular update, layer3 switch send link-state advertisement (LSA) packets to its neighboring layer3 switches. The LSA include links and related costs of that layer3 switch.

5) Each neighboring layer3 switch copies the LSA packet and passes it to the next neighbor (i.e. flooding).

6) Since routing database is not recalculated before layer3 switch forwards LSA flooding, the converging time is greatly reduced.

One major advantage of link-state routing protocols is the fact that infinite counting is impossible, this is because of the way link-state routing protocols build up their routing table. The second advantage is that converging in a link-state interconnected network is very fast, once the routing topology changes, updates will be flooded throughout the network very soon. Those advantages release some layer3 switch resources, as the process ability and bandwidth used by bad route information are minor.

The features of OSPFv3 protocol include the following: OSPFv3 supports networks of various scales, several hundreds of layer3 switches can be supported in an OSPFv3 network. Routing topology changes can be quickly found and updating LSAs can be sent immediately, so that routes converge quickly. Link-state information is used in shortest path algorithm for route calculation, eliminating loop route. OSPFv3 divides the autonomous system into areas, reducing database size, bandwidth occupation and calculation load. (According to the position of layer3 switches in the autonomous system, they can be grouped as internal area switches, area edge switches, AS edge switches and backbone switches). OSPFv3 supports load balance and multiple routes to the same destination of equal costs. OSPFv3 supports 4 level routing mechanisms

(process routing according to the order of route inside an area, route between areas, type 1 external route and type 2 external route). OSPFv3 support IP subnet and redistribution of routes from the other routing protocols, and interface-based packet verification. OSPFv3 supports sending packets in multicast.

Each OSPFV3 layer3 switch maintains a database describing the topology of the whole autonomous system. Each layer3 switch gathers the local status information, such as available interface, reachable neighbors, and sends link-state advertisement (sending out link-state information) to exchange link-state information with other OSPFv3 layer3 switches to form a link-state database describing the whole autonomous system. Each layer3 switch builds a shortest path tree rooted by itself according to the link-state database, this tree provide the routes to all nodes in an autonomous system. If two or more layer3 switches exist (i.e. multi-access network), "designated layer3 switch" and "backup designated layer3 switch" will be selected. Designated layer3 switch is responsible for spreading link-state of the network. This concept helps reducing the traffic among the Layer3 switches in multi-access network.

OSPFv3 protocol requires the autonomous system to be divided into areas. That is to divide the autonomous system into 0 area (backbone area) and non-0 areas. Routing information between areas are further abstracted and summarized to reduce the bandwidth required in the network. OSPFv3 uses four different kinds of routes: they are the route inside the area, route between areas, type 1 external route and type 2 external route, in the order of highest priority to lowest. The route inside an area and between areas describe the internal network structure of an autonomous system, while external routes describe external routes describe how to select the routing information to destination outside the autonomous system. The first type of exterior route corresponds to the information introduced by OSPFv3 from the other interior routing protocols, the costs of those routes are comparable with the costs of OSPFv3 routes; the second type of exterior route corresponds to the information introduced by OSPFv3 from the other exterior routing protocols, but the costs of those routes are far greater than that of OSPFv3 routes, so OSPFv3 route cost is ignored when calculating route costs.

OSPFv3 areas are centered with the Backbone area, identified as the Area 0, all the other areas must be connected to Area 0 logically, and Area 0 must be continuous. For this reason, the concept of virtual link is introduced to the backbone area, so that physically separated areas still have logical connectivity to the backbone area. The configurations of all the layer3 switches in the same area must be the same.

In one word, LSA can only be transferred between neighboring Layer3 switches, and OSPFv3 protocol includes seven kinds of LSA: link LSA, internal-area prefix LSA, router LSA, network LSA, inter-area prefix LSA, inter-area router LSA and autonomic system exterior LSA. Router LSA is generated by each Layer 3 switch in an OSPF area, and is sent to all other neighboring Layer 3 switch in this area; network LSA is generated by designated Layer 3 switch in the OSPF area of multi-access network and is sent to all other neighboring layer3 switches in this area.(To reduce data traffic among each Layer 3 switches in the multi-access network, "designated layer3 switch" and "backup designated layer3 switch" should be selected in the multi-access network, and the network link-state is broadcasted by designated Layer 3 switch); the inter-area prefix LSA and inter-area router LSA are generated by OSPF area border Layer 3 switches and transferred among those switches. The autonomic system exterior LSA is generated by autonomic system exterior border Layer 3 switches and transferred in the whole autonomic

system. Link LSA is generated by Layer 3 switch on the link and sent to other Layer 3 switches on the link. Internal-area prefix LSA is generated by designated layer3 switch of each link in this area, and flooded to the whole area.

For autonomous system focused on exterior link-state announcement, OSPFv3 allow some areas to be configured as STUB areas in order to reduce the size of topological database. Router LSA, network LSA, inter-area prefix LSA, link LSA, internal-area prefix LSA are permitted to advertise to STUB area. Default route must be used in STUB area, Layer 3 switches on the area border of STUB area announces to default routes of STUB area by inter-area prefix LSA; these default routes only flood in STUB area, not outside of STUB area. Each STUB area has a corresponding default route, the route from STUB area to AS exterior destination depends only on default route of this area.

The following simply outlines the route calculation process of OSPFv3 protocol:

- 1) Each OSPF-enabled layer3 switch maintains a database (LS database) describing the link-state of the topology structure of the whole autonomous system. Each layer3 switch generates a link-state advertisement according to its surrounding network topology structure (router LSA), and sends the LSA to other layer3 switches through link-state update (LSU) packets. Thus, each layer3 switches receives LSAs from other layer3 switches, and all LSAs combined to the link-state database.
- 2) Since a LSA is the description of the network topology structure around a layer3 switch, the LS database is the description of the network topology structure of the whole network. The layer3 switches can easily create a weighted vector map according to the LS database. Obviously, all layer3 switches in the same autonomous system will have the same network topology map.
- 3) Each layer3 switch uses the shortest path first (SPF) algorithm to calculate a tree of shortest path rooted by itself. The tree provides the route to all the nodes in the autonomous system, leaf nodes consist of the exterior route information. The exterior route can be marked by the layer3 switch broadcast it, so that additional information about the autonomous system can be recorded. As a result, the route table of each layer3 switch is different.

OSPFv3 protocol is developed by the IETF, the OSPF v3 used now is fulfilled according to the content described in RFC2328 and RFC2740.

As a result of continuous development of IPv6 network, it has the network environment of nonsupport IPv6 sometimes, so it needs to do the IPv6 operation by tunnel. Therefore, our OSPFv3 supports configuration on configure tunnel, and passes through nonsupport IPv6 network by unicast packet of IPv4 encapsulation.

13.5.2 OSPFv3 Configuration Task List

OSPFv3 Configuration Task List:

1. Enable OSPFv3 (required)
 - (1) Enable/disable OSPFv3 (required)
 - (2) Configure the router-id number of the layer3 switch running OSPFv3 (optional)

- (3) Configure the network scope for running OSPFv3 (optional)
- (4) Enable OSPFv3 on the interface (required)
- 2. Configure OSPFv3 auxiliary parameters (optional)
 - (1) Configure OSPFv3 packet sending mechanism parameters
 - 1) Set the OSPFv3 interface to receive only
 - 2) Configure the cost for sending packets from the interface
 - 3) Configure OSPFv3 packet sending timer parameter (timer of broadcast interface sending HELLO packet to poll, timer of neighboring layer3 switch invalid timeout, timer of LSA transmission delay and timer of LSA retransmission).
 - (2) Configure OSPFv3 route introduction parameters
 - 1) Configure default parameters (default type, default tag value, default cost)
 - 2) Configure the routes of the other protocols to introduce to OSPFv3
 - (3) Configure OSPFv3 importing the routes of other OSPFv3 processes
 - 1) Enable the function of OSPFv3 importing the routes of other OSPFv3 processes
 - 2) Display relative information
 - 3) Debug
 - (4) Configure other OSPFv3 protocol parameters
 - 1) Configure OSPFv3 routing protocol priority
 - 2) Configure cost for OSPFv3 STUB area and default route
 - 3) Configure OSPFv3 virtual link
 - 4) Configure the priority of the interface when electing designated layer3 switch
- 3. Close OSPFv3 Protocol

1. Enable OSPFv3 Protocol

It is very simple to run the basic configurations of OSPFv3 routing protocol on the Layer 3 switch, normally only enabling OSPFv3, implement OSPFv3 interface, the default value is defined to OSPFv3 protocol parameters. Refer to 2. Configure OSPF auxiliary parameters, if the OSPFv3 protocol parameters need to be modified.

Commands	Explanation
Global Mode	
[no] router IPv6 ospf <tag>	The command initializes OSPFv3 routing process and enter OSPFv3 mode to configure OSPFv3 routing process. The no router IPv6 ospf <tag> command stops relative process. (required)
OSPFv3 Protocol Configure Mode	
router-id <router_id> no router-id	Configure router for OSPFv3 process. The no router-id command returns ID to 0.0.0.0 .(required)
[no] passive-interface<ifname>	Configure an interface receiving without sending. The no passive-interface<ifname>

	command cancels configuration.
Interface Configuration Mode	
[no] IPv6 router ospf {area <area-id> [instance-id <instance-id> tag <tag> [instance-id <instance-id>]] tag <tag> area <area-id> [instance-id <instance-id>]}	Implement OSPFv3 routing on the interface. The no IPv6 router ospf {area <area-id> [instance-id <instance-id> tag <tag> [instance-id <instance-id>]] tag <tag> area <area-id> [instance-id <instance-id>]} command cancels configuration.

2. Configure OSPFv3 parameters

(1) Configure OSPFv3 packet sending mechanism parameters

- 1) Set the OSPF interface to receive only
- 2) Configure the cost for sending packets from the interface

Commands	Explanation
Interface Configuration Mode	
IPv6 ospf cost <cost> [instance-id <id>] no IPv6 ospf cost [instance-id <id>]	Appoint interface to implement required cost of OSPFv3 protocol. The no IPv6 OSPF cost [instance-id <id>] restores the default setting.

3) Configure OSPFv3 packet sending timer parameter (timer of broadcast interface sending HELLO packet to poll, timer of neighboring layer3 switch invalid timeout, timer of LSA transmission delay and timer of LSA retransmission).

Commands	Explanation
Interface Configuration Mode	
IPv6 ospf hello-interval <time> [instance-id <id>] no IPv6 ospf hello-interval [instance-id <id>]	Sets interval for sending HELLO packets; the no IPv6 ospf hello-interval [instance-id <id>] command restores the default setting.
IPv6 ospf dead-interval <time> [instance-id <id>] no IPv6 ospf dead-interval [instance-id <id>]	Sets the interval before regarding a neighbor layer3 switch invalid; the no IPv6 ospf dead-interval [instance-id <id>] command restores the default setting.
IPv6 ospf transit-delay <time> [instance-id <id>] no IPv6 ospf transit-delay [instance-id <id>]	Sets the delay time before sending link-state broadcast; the no IPv6 ospf transit-delay [instance-id <id>] command restores the default setting.
IPv6 ospf retransmit <time> [instance-id <id>] no IPv6 ospf retransmit [instance-id <id>]	.Sets the interval for retransmission of link-state advertisement among neighbor layer3 switches; the no IPv6 ospf retransmit [instance-id <id>] command restores the default setting.

(2) Configure OSPFv3 route introduction parameters

Configure OSPFv3 route introduction parameters

Commands	Explanation
----------	-------------

OSPF Protocol Mode	
[no] redistribute {kernel connected static rip isis bgp} [metric<value>] [metric-type {1 2}][route-map<word>]	Introduces other protocol discovery routing and static routing regarded as external routing message. The no redistribute {kernel connected static rip isis bgp} [metric<value>] [metric-type {1 2}][route-map<word>] command cancels imported external routing message.

(3) Configure OSPFv3 importing the routes of other OSPFv3 processes

1) Enable the function of OSPFv3 importing the routes of other OSPFv3 processes

Command	Explanation
Router IPv6 OSPF Mode	
redistribute ospf [<process-id>] [metric<value>] [metric-type {1 2}][route-map<word>] no redistribute ospf [<process-id>] [metric<value>] [metric-type {1 2}][route-map<word>]	Enable or disable the function of OSPFv3 importing the routes of other OSPFv3 processes.

2) Display relative information

Command	Explanation
Admin Mode or Configure Mode	
show ipv6 ospf [<process-id>] redistribute	Display the configuration information of the OSPFv3 process importing other outside routes.

3) Debug

Command	Explanation
Admin Mode	
debug ipv6 ospf redistribute message send no debug ipv6 ospf redistribute message send debug ipv6 ospf redistribute route receive no debug ipv6 ospf redistribute route receive	Enable or disable debugging of sending command from OSPFv3 process redistributed to other OSPFv3 process routing. Enable or disable debugging of received routing message from NSM for OSPFv3 process.

(4) Configure Other Parameters of OSPFv3 Protocol

1) Configure OSPFv3 STUB Area & Default Routing Cost

2) Configure OSPFv3 Virtual Link

Commands	Explanation
OSPFv3 Protocol Configuration Mode	

timers spf <spf-delay> <spf-holdtime> no timers spf	Configure OSPFv3 SPF timer. The no timers spf command recovers default value.
area <id> stub [no-summary] no area <id> stub [no-summary] area <id> default-cost <cost> no area <id> default-cost area <id> virtual-link A.B.C.D [instance-id <instance-id> INTERVAL] no area <id> virtual-link A.B.C.D [INTERVAL]	Configure parameters in OSPFv3 area (STUB area, Virtual link). The no command restores default value.

4) Configure the priority of the interface when electing designated layer3 switch (DR).

Commands	Explanation
Interface Configuration Mode	
IPv6 ospf priority <priority> [instance-id <id>] no IPv6 ospf priority [instance-id <id>]	Sets the priority of the interface in “designated layer3 switch” election; the “ no IPv6 ospf priority [instance-id <id>]” command restores the default setting.

3. Disable OSPFv3 Protocol

Commands	Explanation
Global Mode	
no router IPv6 ospf ospf [<tag>]	Disable OSPFv3 Routing Protocol.

13.5.3 OSPFv3 Examples

Examples 1: OSPF autonomous system.

This scenario takes an OSPF autonomous system consists of five switch for example.

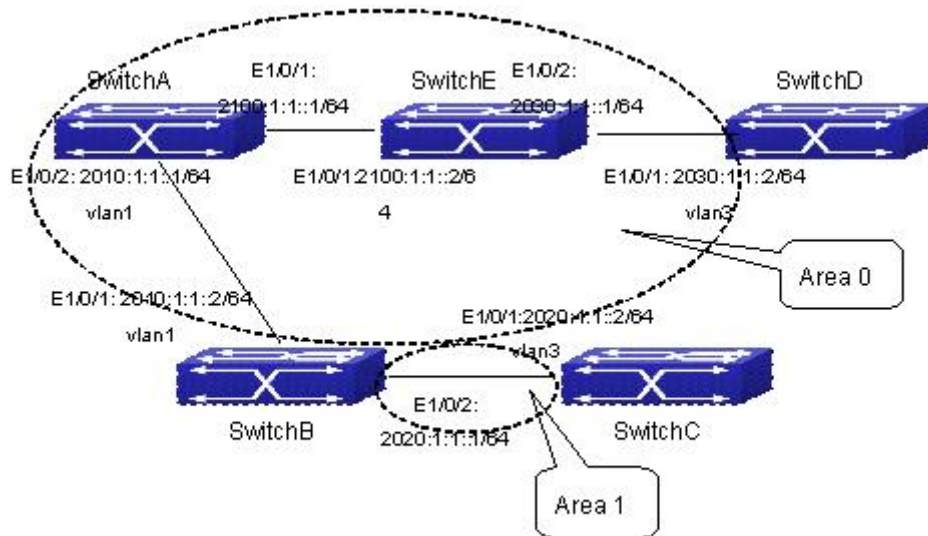

Figure 14-6 Network topology of OSPFv3 autonomous system

The configuration for layer3 SwitchA and SwitchE is shown below:

Layer3 SwitchA:

Enable OSPFv3 protocol, configure router ID

```
SwitchA(config)#router IPv6 ospf
```

```
SwitchA (config-router)#router-id 192.168.2.1
```

Configure interface vlan1 IPv6 address and affiliated OSPFv3 area

```
SwitchA#config
```

```
SwitchA(config)# interface vlan 1
```

```
SwitchA(config-if-vlan1)# IPv6 address 2010:1:1::1/64
```

```
SwitchA(config-if-vlan1)# IPv6 router ospf area 0
```

```
SwitchA(config-if-vlan1)#exit
```

Configure interface vlan2 IP address and affiliated OSPFv3 area

```
SwitchA(config)# interface vlan 2
```

```
SwitchA(config-if-vlan2)# IPv6 address 2100:1:1::1/64
```

```
SwitchA(config-if-vlan2)# IPv6 router ospf area 0
```

```
SwitchA (config-if-vlan2)#exit
```

```
SwitchA(config)#exit
```

```
SwitchA#
```

Layer 3 SwitchB:

Enable OSPFv3 protocol, configure router ID

```
SwitchB(config)#router IPv6 ospf
```

```
SwitchB (config-router)#router-id 192.168.2.2
```

Configure interface vlan1 address, VLAN2 IPv6 address and affiliated OSPFv3 area

```
SwitchB#config
```

```
SwitchB(config)# interface vlan 1
```

```
SwitchB(config-if-vlan1)# IPv6 address 2010:1:1::2/64
```

```
SwitchB(config-if-vlan1)# IPv6 router ospf area 0
```

```
SwitchB(config-if-vlan1)#exit
```

```
SwitchB(config)# interface vlan 3
```



```
SwitchB(config-if-vlan3)# IPv6 address 2020:1:1::1/64
SwitchB(config-if-vlan3)# IPv6 router ospf area 1
SwitchB(config-if-vlan3)#exit
SwitchB(config)#exit
SwitchB#
Layer 3 SwitchC:
Enable OSPFv3 protocol, configure router ID
SwitchC(config)#router IPv6 ospf
SwitchC(config-router)#router-id 192.168.2.3
Configure interface vlan3 IPv6 address and affiliated OSPFv3 area
SwitchC#config
SwitchC(config)# interface vlan 3
SwitchC(config-if-vlan3)# IPv6 address 2020:1:1::2/64
SwitchC(config-if-vlan3)# IPv6 router ospf area 1
SwitchC(config-if-vlan3)#exit
SwitchC(config)#exit
SwitchC#
Layer 3 SwitchD:
Enable OSPFv3 protocol, configure router ID
SwitchD(config)#router IPv6 ospf
SwitchD(config-router)#router-id 192.168.2.4
Configure interface vlan3 IPv6 address and affiliated OSPFv3 area
SwitchD#config
SwitchD(config)# interface vlan 3
SwitchD(config-if-vlan3)# IPv6 address 2030:1:1::2/64
SwitchD(config-if-vlan3)# IPv6 router ospf area 0
SwitchD(config-if-vlan3)#exit
SwitchD(config)#exit
SwitchD#
Layer 3 SwitchE:
Startup OSPFv3 protocol, configure router ID
SwitchE(config)#router IPv6 ospf
SwitchE(config-router)#router-id 192.168.2.5
Configure interface IPv6 address and affiliated OSPFv3 area
SwitchE#config
SwitchE(config)# interface vlan 2
SwitchE(config-if-vlan2)# IPv6 address 2100:1:1::2/64
SwitchE(config-if-vlan2)# IPv6 router ospf area 0
SwitchE(config-if-vlan2)#exit
Configure interface VLAN3 IPv6 address and affiliated area
SwitchE(config)# interface vlan 3
SwitchE(config-if-vlan3)# IPv6 address 2030:1:1::1/64
SwitchE(config-if-vlan3)# IPv6 router ospf area 0
SwitchE(config-if-vlan3)#exit
```

```
SwitchE(config)#exit
SwitchE#
```

13.5.4 OSPFv3 Troubleshooting

In the process of configuring and implementing OSPFv3, physical connection, configuration false probably leads to OSPFv3 protocol doesn't work. Therefore, the customers should give their attention to it:

- ☞ First of all, to ensure correct physical connection;
- ☞ Secondly, to ensure interface and link protocol are UP (execute **show interface** instruction);
- ☞ And configure IPv6 address of the different net segment on every interface.
- ☞ To startup OSPFv3 protocol (execute **router IPv6 OSPF** instruction), and configure affiliated OSPFv3 area on relative interface.
- ☞ And then, consider OSPFv3 protocol characteristic —— OSPFv3 backbone area (area 0) must be continuous. If it doesn't ensure that virtual link is implemented continuously, all of not area 0 only can be connected by area 0 and other not area 0, not directly connected by not area 0; The border Layer 3 switch is a part of this Layer 3 switch interface belongs to area 0, and another part of interface belongs to not area 0; for multi-access net etc like broadcast, Layer 3 switch DR needs vote and appoint; for each OSPFv3 process must not configure router ID of 0.0.0.0 address.

13.6 MBGP4+

13.6.1 Introduction to MBGP4+

MBGP4+ is multi-protocol BGP (Multi-protocol Border Gateway Protocol) extension to IPv6, referring to BGP protocol chapter about BGP protocol introduction in this manual. Different from RIPng and OSPFv3, BGP has no corresponding independent protocol for IPv6; instead, it takes extensions to address families on the original BGP. The extensions to BGP by MBGP4+ are mostly embodied:

- a. neighbor address configured can be IPv6 address;
- b. Increase IPv6 unicast address family configuration.

13.6.2 MBGP4+ Configuration Task List

MBGP4+ Configuration Task List:

1. Configure IPv6 neighbor

2. Configure and enable IPv6 address family
3. Configure redistribution of OSPFv3 routing to MBGP4+
 - 1) Enable redistribution of OSPFv3 routing to MBGP4+
 - 2) Display and debug the information about configuration of redistribution of OSPFv3 routing to MBGP4+

1. Configure IPv6 neighbor

Command	Explanation
BGP Protocol Configuration Mode	
neighbor <X:X::X:X> remote-as <as-id>	Configure IPv6 neighbor.

2. Configure and activate IPv6 address family

Command	Explanation
BGP Protocol Configuration Mode	
address-family IPv6 unicast	Enter IPv6 unicast address family.
BGP protocol address family configuration mode	
neighbor <X:X::X:X> activate no neighbor <X:X::X:X> activate	Configure IPv6 neighbor to activate/inactivate the address family.
exit-address-family	Exit address family configuration mode.

3. Configure redistribution of OSPFv3 routing to MBGP4+

- (1) Enable redistribution of OSPFv3 routing to MBGP4+

Command	Explanation
Router IPv6 BGP Configuration Mode	
redistribute ospf [<process-tag>] [route-map<word>] no redistribute ospf [<process-tag>]	To enable or disable redistribution of OSPFv3 routing to MBGP4+.

- (2) Display and debug the information about configuration of redistribution of OSPFv3 routing to MBGP4+

Command	Explanation
Admin Mode and Configuration Mode	
show ipv6 bgp redistribute	To display configuration information about MBGP4+ routing which is redistributed from other routing protocols.
Admin Mode	
debug ipv6 bgp redistribute message send no debug ipv6 bgp redistribute message send debug ipv6 bgp redistribute route receive no debug ipv6 bgp redistribute route receive	To enable or disable debugging messages sent by MBGP4+ for redistribution of OSPFv3 routing. To enable or disable debugging messages received from NSM.

13.6.3 MBGP4+ Examples

SwitchB, SwitchC and SwitchD are in AS200, SwitchA is in AS100. SwitchA and SwitchB share the same network segment. SwitchB and SwitchD are not connected physically.

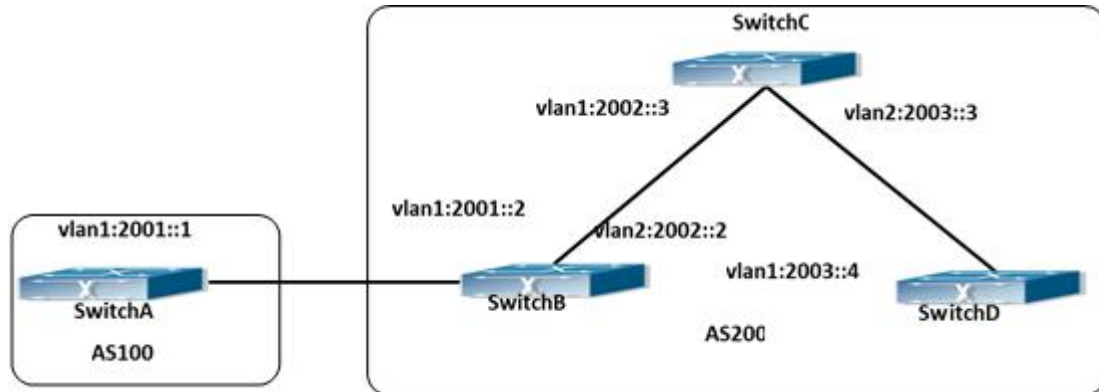

Figure 14- 7 BGP Network Topological Map

Accordingly SwitchA configuration as follows:

```
SwitchA(config)#router bgp 100
SwitchA(config-router)#bgp router-id 1.1.1.1
SwitchA(config-router)#neighbor 2001::2 remote-as 200
SwitchA(config-router)#address-family IPv6 unicast
SwitchA(config-router-af)#neighbor 2001::2 activate
SwitchA(config-router-af)#exit-address-family
SwitchA(config-router-bgp)#exit
SwitchA(config)#
```

SwitchB configuration as follows:

```
SwitchB(config)#router bgp 200
SwitchA(config-router)#bgp router-id 2.2.2.2
SwitchB(config-router)#neighbor 2001::1 remote-as 100
SwitchB(config-router)#neighbor 2002::3 remote-as 200
SwitchB(config-router)#neighbor 2003::4 remote-as 200
SwitchB(config-router)#address-family IPv6 unicast
SwitchB(config-router-af)#neighbor 2001::1 activate
SwitchB(config-router-af)#neighbor 2002::3 activate
SwitchB(config-router-af)#neighbor 2003::4 activate
SwitchB(config-router-af)#exit-address-family
SwitchB(config-router)#exit
SwitchB(config)#
```

SwitchC configuration as follows:

```
SwitchC(config)#router bgp 200
SwitchA(config-router)#bgp router-id 2.2.2.2
SwitchC(config-router)#neighbor 2002::2 remote-as 200
SwitchC(config-router)#neighbor 2003::4 remote-as 200
```

```
SwitchC(config-router)#address-family IPv6 unicast
SwitchC(config-router-af)#neighbor 2002::2 activate
SwitchC(config-router-af)#neighbor 2003::4 activate
SwitchC(config-router-af)#exit-address-family
SwitchC(config-router-bgp)#exit
```

SwitchD configuration as follows:

```
SwitchD(config)#router bgp 200
SwitchA(config-router)#bgp router-id 2.2.2.2
SwitchD(config-router)#neighbor 2003::3 remote-as 200
SwitchD(config-router)#neighbor 2002::2 remote-as 200
SwitchD(config-router)#address-family IPv6 unicast
SwitchD(config-router-af)#neighbor 2002::2 activate
SwitchD(config-router-af)#neighbor 2003::3 activate
SwitchD(config-router-af)#exit-address-family
SwitchD(config-router)#exit
```

Here the connection between SwitchB and SwitchA is EBGP, and the connection between SwitchC and SwitchD is IBGP. The BGP connection can be processed between SwitchB and SwitchD without physical link, but the premise is a route which reaches from one switch to the other switch. The route can be obtained by static routing or IGP.

13.6.4 MBGP4+ Troubleshooting

It is the same as corresponding section of BGP.

13.7 IPv6 Black Hole Routing

13.7.1 Introduction to Black Hole Routing

Black Hole Routing is a special kind of static routing which drops all the datagrams that match the routing rule.

13.7.2 IPv6 Black Hole Routing Configuration Task

1. Enable the IPv6 function
2. Configure the IPv6 Black Hole Routing

1. Enable the IPv6 function

Command	Explanation
---------	-------------

Global Configuration Mode	
ipv6 enable	To enable the IPv6 function on the switch.

2. Configure IPv6 Black Hole Routing

Command	Explanation
Global Configuration Mode	
ipv6 route <ipv6-prefix/prefix-length> null0 [<precedence>] no ipv6 route <ipv6-prefix/prefix-length> null0	To configure static IPv6 Black Hole Routing. The no form of this command will remove the specified configuration.

13.7.3 Black Hole Routing Configuration Exmaples

Example 1: IPv6 Black Hole Routing function.

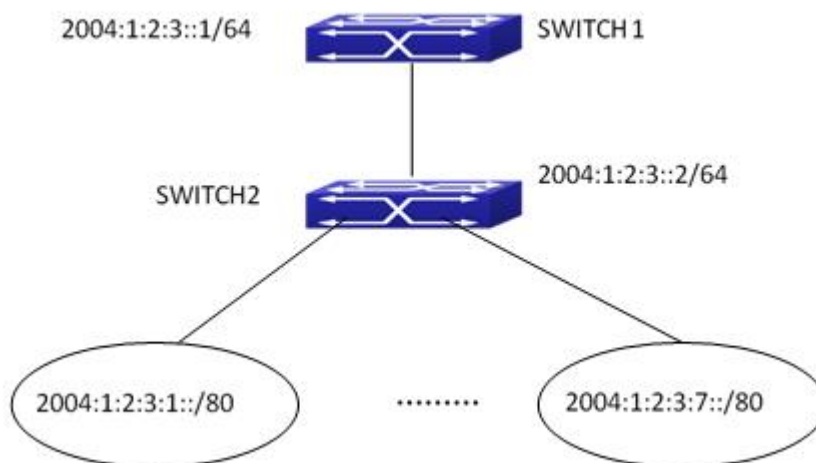

Figure 14-8 IPv6 Black Hole Routing Configuration Example

As it is shown in the figure, in Switch 2, eight in all interfaces are configured as Layer 3 VLAN interfaces for access interfaces. The network addresses are 2004:1:2:3:1/80~2004:1:2:3:7/80. A default routing is configured on Switch 2 to connect to Switch 1. And a backward default routing is configured on Switch 1 to Switch 2, whose network address is 2004:1:2:3::/64. Commonly, this configuration will work well. However, if one of the Layer 3 interfaces in Switch 2 goes down, for example, the interface belonged to 2004:1:2:3:1/80. When datagrams arrives at VLAN1 in Switch 2, there will be no routing rules for these datagrams. The switch then will forward these datagrams according to the default routing, back to Switch 1. When Switch 1 receives these datagrams, it will forward them back to Switch 2. Thus, loopback exists. To solve this problem, Black Hole Routing can be introduced on Switch 2.

```
ipv6 route 2004:1:2:3::/64 null0 50
```

Then Switch 2 will drop the datagrams from interface VLAN1 that match the Black Hole Routing rule. And loopback routing is prevented.

Configuration steps are listed as below:

```
Switch#config
Switch(config)#ipv6 route 2004:1:2:3::/64 null0 50
```

13.7.4 Black Hole Routing Troubleshooting

When configuring the Black Hole Routing function, the configuration may not work due to some reasons such as incorrect network address mask, and incorrect management distance. Attention should be paid to the following items:

- ☞ IPv6 should be enabled before IPv6 Black Hole Routing can work.
- ☞ It is suggested that the length of the network address mask should be longer than that of normal routing configuration, in order to prevent the Black Hole Routing from intervening other routing configuration.
- ☞ When the network address mask of Black Hole Routing configuration is the same with some other configuration, it is suggested that the distance of Black Hole Routing is set lower.

For problems that cannot be fixed through above methods, please issue the command `show ip route distance` and `show ip route fib`, and `show l3`. And copy and paste the output of the commands, and send to the technical service center of our company.

13.8 IPv6 Multicast Protocol

13.8.1 PIM-DM6

13.8.1.1 Introduction to PIM-DM6

PIM-DM6 (Protocol Independent Multicast, Dense Mode) is the IPv6 version of Protocol Independent Multicast Dense Mode. It is a Multicast Routing Protocol in dense mode which adapted to small network. The members of multicast group are relatively dense under this kind of network environment. There is no difference compared with the IPv4 version PIM-DM except that the addresses it uses are IPv6 addresses. Thus we don't differentiate between PIM-DM and PIM-DM6 in this chapter. All PIM-DM in the text without specific explanation refers to IPv6 version PIM-DM.

As a result of continuous development of IPv6 network, it has the network environment of nonsupport IPv6 multicast sometimes, so it needs to do the IPv6 multicast operation by tunnel. Therefore, our PIM-DM6 supports configuration on configure tunnel, and passes through nonsupport IPv6 multicast network by single cast packet of IPv4 encapsulation.

The working process of PIM-DM can be summarized as: Neighbor Discovery, Flooding-Prune, and Graft.

1. Neighbor Discovery

When PIM-DM router is started at beginning, Hello message is required to discover neighbors. The network nodes running PIM-DM use Hello message to contact each other.

PIM-DM Hello message is sent periodically.

2. Flooding-Prune

PIM-DM assumes that all hosts on the network are ready to receive multicast data. When certain multicast source S begins to send data to a multicast group G, after receiving the multicast packet, the router will make RPF examination first according to the unicast table. If the check passes, the router will create a (S, G) table item and forward the multicast packet to all downstream PIM-DM nodes (Flooding). If the RPF examination fails, i.e. the multicast packet is inputted from the incorrect interface, and then the message is discarded. After this procedure, every node will create an (S, G) item in the PIM-DM multicast domain. If there is no multicast group member in the downstream nodes, then a Prune message is sent to upstream nodes notifying not to forward data to this multicast group any more. After receiving Prune message, the corresponding interfaces will be deleted from the output interface list corresponding with the multicast-forwarding item (S, G). Through this process, a SPT (Shortest Path Tree) is established with source S as root. Prune process is started by a sub-router.

The process above is called Flooding-Prune process. Each pruned node also provides overtime mechanism at the same time. In case of overtime of prune, the router will restart flooding-prune process. Flooding-prune of PIM-DM is conducted periodically

3. RPF examination

Adopting RPF examination, PIM-DM establishes a multicast forwarding tree initiating from data source, using existing unicast routing table. When a multicast packet arrives, the router will determine the correctness of its coming path first. If the arrival interface is the interface connected to multicast source indicated by unicast routing, then this multicast packet is considered to be from the correct path; otherwise the multicast packet will be discarded as redundant message. The unicast routing message used as path judgment can root in any Unicast Routing Protocol, such as messages found by RIP, OSPF, etc. It doesn't rely on any specific unicast routing protocol.

4. Assert Mechanism

If two multicast router A and B in the same LAN segment have their own receiving paths to multicast source S, they will respectively forward multicast data packet to LAN after receiving the packet from multicast source S. Then downstream nodes multicast router C will receive two multicast packets that are exactly the same. Once router detects such circumstance, a unique forwarder will be selected through "assert" mechanism. The optimized forwarding path is selected through "assert" packet. If the priority and costs of two or more than two paths are same, the node with a larger IP address will be selected as the upstream neighbor of item (S, G), which will be responsible for forwarding the (S, G) multicast packet.

5. Graft

When the pruned downstream node needs to recover to forwarding status, this node uses Graft Message to notify upstream nodes to resume multicast data forwarding.

13.8.1.2 PIM-DM6 Configuration Task List

1. Enable PIM-DM (Required)
2. Configure static multicast routing entries (Optional)
3. Configure additional PIM-DM parameters (Optional)

- (1) Configure parameters for PIM-DM interfaces
 - 1) Configure the interval for PIM-DM hello messages
 - 2) Configure the interval for PIM-DM state-refresh messages
 - 3) Configure the boundary interfaces
 - 4) Configure the management boundary
4. Disable PIM-DM protocol

1. Enable the PIM-DM protocol

On the switch, PIM-DM can be enabled through two steps. Firstly PIM multicast routing should be enabled in global configuration mode, then PIM-DM should be configured for the specific interfaces.

Command	Explanation
Command configuration mode	
ipv6 pim multicast-routing	To enable PIM-DM multicast routing global. However, in order to enable PIM-DM for specific interfaces, the following command must be issued.

Enable PIM-SM for the specific interface:

Command	Explanation
Interface configuration mode	
ipv6 pim dense-mode	To enable PIM-DM for the specified interface (required).

2. Configure static multicast routing entries

Command	Explanation
Global configuration mode	
ipv6 mroute <X:X::X:X> <X:X::X:X> <ifname> <.ifname> no ipv6 mroute <X:X::X:X> <X:X::X:X> [<ifname> <.ifname>]	To configure IPv6 static multicast routing entries. The no form of this command will remove the specified routing entry.

3. Configure additional PIM-DM parameters

- (1) Configure parameters for PIM-DM interfaces

- 1) Configure the interval for PIM-DM hello messages

Command	Explanation
Interface Configuration Mode	
ipv6 pim hello-interval <interval> no ipv6 pim hello-interval	To configure the interval for PIM-DM hello messages. The no form of this command will restore the default value.

- 2) Configure the interval for PIM-DM state-refresh messages

Command	Explanation
Interface Configuration Mode	

ipv6 pim state-refresh origination-interval no ipv6 pim state-refresh origination-interval	To configure the interval for sending PIM-DM state-refresh packets. The no form of this command will restore the default value.
---	---

3) Configure the boundary interfaces

Command	Explanation
Interface Configuration Mode	
ipv6 pim bsr-border no ipv6 pim bsr-border	To configure the interface as the boundary of PIM-DM6 protocol. On the boundary interface, STATE REFRESH messages will not be sent or received. The network connected the interface is considered as directly connected network. The no form of this command will remove the configuration.

4) Configure the management boundary

Command	Explanation
Interface Configuration Mode	
ipv6 pim scope-border <500-599> <acl_name> no ipv6 pim scope-border	To configure PIM-DM6 management boundary for the interface and apply ACL for the management boundary. With default settings, ffx0::/13 is considered as the scope of the management group. If ACL is configured, then the scope specified by ACL permit command is the scope of the management group. acl_name should be standard IPv6 ACL name. The no form of this command will remove the configuration.

4. Disable PIM-DM protocol

Command	Notes
Interface Configuration Mode	
no ipv6 pim dense-mode	To disable PIM-DM for the specified interface.
Global Configuration Mode	
no ipv6 pim multicast-routing	To disable PIM-DM globally.

13.8.1.3 PIM-DM6 Typical Application

As shown in the following figure, add the Ethernet interfaces of Switch A and Switch B to corresponding vlan, and start PIM-DM Protocol on each vlan interface.

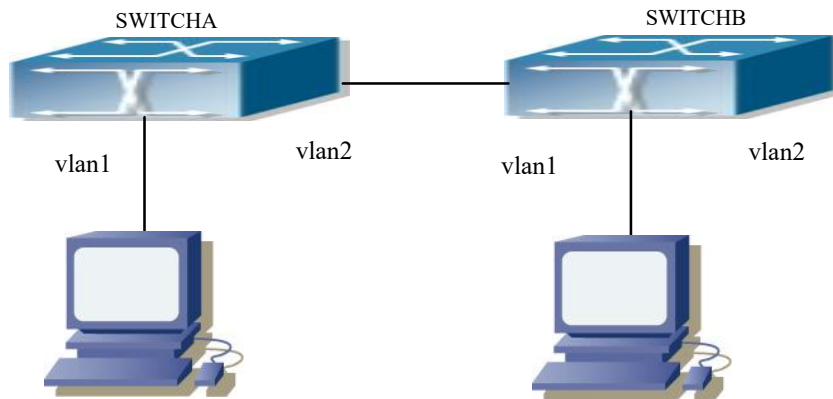

Figure 14-9 PIM-DM Typical Environment

The configuration procedure for SwitchA and SwitchB is as below:

(1) Configure SwitchA:

```
Switch(config)#ipv6 pim multicast-routing
Switch(config)#interface vlan 1
Switch(Config-if-Vlan1)#ipv6 address 2000:10:1:1::1/64
Switch(Config-if-Vlan1)#ipv6 pim dense-mode
Switch(Config-if-Vlan1)#exit
Switch(config)#interface vlan2
Switch(Config-if-Vlan2)#ipv6 address 2000:12:1:1:: 1/64
Switch(Config-if-Vlan2)#ipv6 pim dense-mode
```

(2) Configure SwitchB:

```
Switch(config)#ip pim multicast-routing
Switch(config)#interface vlan 1
Switch(Config-if-Vlan1)#ipv6 address 2000:12:1:1::2/64
Switch(Config-if-Vlan1)#ipv6 pim dense-mode
Switch(Config-if-Vlan1)#exit
Switch(config)#interface vlan 2
Switch(Config-if-Vlan2)#ipv6 address 2000:20:1:1::1/64
Switch(Config-if-Vlan2)#ipv6 pim dense-mode
```

13.8.1.4 PIM-DM6 Troubleshooting

When configuring and using PIM-DM protocol, PIM-DM protocol may fail to work normally due to physical connections, incorrect configuration and so on. So, users shall note the following points:

- ☞ Assure the physical connection is correct.
- ☞ Assure the Protocol of Interface and Link is UP (use show interface command);
- ☞ Assure PIM Protocol is turned on in Global Mode (use ipv6 pim multicast-routing command)
- ☞ Start PIM-DM Protocol on the interface (use ipv6 pim dense-mode command)

Unicast route shall be used to carry out RPF examination for multicast protocol. So the correctness of unicast route shall be guaranteed above all. If all attempts fail to solve the problems

on PIM-DM, then use debug commands such as debug ipv6 pim, copy DEBUG information in 3 minutes and send to Technology Service Center.

13.8.2 PIM-SM6

13.8.2.1 Introduction to PIM-SM6

PIM-SM6 (Protocol Independent Multicast, Sparse Mode) is the IPv6 version of Protocol Independent Multicast Sparse Mode. It is a multicast routing protocol in sparse mode and mainly used in large network with group members distributed relatively sparse and wide. It is no difference from the IPv4 version PIM-SM except the addresses it uses are IPv6 addresses. Thus we don't differentiate between PIM-SM and PIM-SM6 in this chapter. All PIM-SM in the text without specific explanation is IPv6 version PIM-SM. Unlike the Flooding-Prune of Dense Mode, PIM-SM Protocol assumes no host needs receiving multicast data packets. PIM-SM router forwards multicast data packets to a host only on definite request.

By setting RP (Rendezvous Point) and BSR (Bootstrap Router), PIM-SM announce multicast packet to all PIM-SM routers and establish, using Join/Prune message of routers, RPT (RP-rooted shared tree) based on RP. Consequently the network bandwidth occupied by data packets and control messages is cut down and the transaction cost of routers is reduced. Multicast data get to the network segment where the multicast group members are located along the shared tree flow. When the data traffic reaches a certain amount, multicast data stream can be switched to source-based SPT (Shortest Path Tree) to shorten network delay. PIM-SM doesn't rely on any specific unicast routing protocol but make RPF examination using existing unicast routing table.

1. PIM-SM Working Principle

The working process of PIM-SM mainly includes neighbor discovery, creation of RPT, registration of multicast source, SPT switch and so on. The neighbor discovery mechanism is the same with the mechanism of PIM-DM. We won't introduce any more.

(1) Creation of RP Shared Tree (RPT)

When a host joins a multicast group G, the leaf router directly connected with the host finds out through IGMP message that there is a receiver of multicast group G, then it works out the corresponding Rendezvous Point RP for multicast group G, and send join message to upper level nodes in RP direction. Every router on the way from the leaf router to RP will create a (*, G) table item, indicating the message from any source to multicast group G is suitable for this item. When RP receives the message sent to multicast group G, the message will get to the leaf router along the established path and then reach the host. In this way, the RPT with RP as root is created.

(2) Multicast Source Registration

When multicast source S sends a multicast packet to multicast group G, the PIM-SM multicast router directly connected to it will take charge of sealing the multicast packet into registered message and unicast it to corresponding RP. If there are more than one PIM-SM multicast routers on a network segment, then DR (Designated Router) takes charge of forwarding the multicast packet.

(3) SPT Switch

Once the multicast router finds that the rate of the multicast packet from RP with destination address G exceeds threshold, the multicast router will send Join message to the upper lever nodes in the source direction, which results in the switch from RPT to SPT.

2. Preparation before PIM-SM configuration

(1) Configuration Candidate RP

More than one RPs (candidate RP) are permitted in PIM-SM network and each C-RP (Candidate RP) takes charge of forwarding multicast packets with destination address in a certain range. To configure more than one candidate RPs can achieve RP load balancing. There is no master or slave difference among RPs. All multicast routers work out the RP corresponded with certain multicast group based on the same algorithm after receiving the candidate RP message announced by BSR.

Note that one RP can serve more than one multicast groups, even all multicast groups. But each multicast group can only correspond with one unique RP at any moment. It can't correspond with more RPs at the same time.

(2) BSR Configuration

As the management core of PIMSM network, BSR is in charge of collecting messages sent by candidate RPs and broadcast them..

There may be only one BSR within a network. However, there may be several candidate BSRs to be configured. With such arrangement, once a BSR fails, another may be switched to. C-BSR determines BSR through automatic selection.

13.8.2.2 PIM-SM6 Configuration Task List

1. Enable PIM-SM (Required)
2. Configure static multicast routing entries (Optional)
3. Configure additional parameters for PIM-SM (Optional)
 - (1) Configure parameters for PIM-SM interfaces
 - 1) Configure the interval for PIM-SM hello messages
 - 2) Configure the holdtime for PIM-SM hello messages
 - 3) Configure ACL for PIM-SM6 neighbors
 - 4) Configure the interface as the boundary interface of the PIM-SM6 protocol
 - 5) Configure the interface as the management boundary of the PIM-SM6 protocol
 - (2) Configure global PIM-SM parameters
 - 1) Configure the switch as a candidate BSR
 - 2) Configure the switch as a candidate RP
 - 5)Configure static RP
 - 3) Configure the cache time of kernel multicast route
4. Disable the PIM-SM protocol

1. Enable PIM-SM protocol

The PIM-SM protocol can be enabled on Layer 3 switches by enabling PIM6 in global

configuration mode and then enabling PIM-SM for specific interfaces in the interface configuration mode.

Command	Explanation
Global Configuration Mode	
[no] ipv6 pim multicast-routing	To enable the PIM-SM6 protocol for all the interfaces (However, in order to make PIM-SM work for specific interfaces, the following command should be issued). (required)

Make the PIM-SM protocol work for specific interfaces

Command	Explanation
Interface Configuration Mode	
[no] ipv6 pim sparse-mode [passive]	To enable PIM-SM for the specified interface. The no form of this command will disable the PIM-SM protocol (required).

2. Configure static multicast routing entries

Command	Explanation
Global Configuration Mode	
ipv6 mroute <X:X::X:X> <X:X::X:X> <ifname> <ifname> no ipv6 mroute <X:X::X:X> <X:X::X:X> [<ifname> <ifname>]	To configure a static multicast routing entry. The no form of this command will remove the specified static multicast routing entry.

3. Configure the additional parameters for PIM-SM

(1) Configure parameters for PIM-SM interfaces

1) Configure the interval for PIM-SM hello messages

Command	Explanation
Interface Configuration Mode	
ipv6 pim hello-interval <interval> no ipv6 pim hello-interval	To configure the interval for PIM-SM hello messages. The no form of this command restores the interval to the default value.

2) Configure the hold time for PIM-SM6 hello messages

Command	Explanation
Interface Configuration Mode	
ipv6 pim hello-holdtime <value> no ipv6 pim hello-holdtime	To configure the value of the holdtime field in the PIM-SM hello messages. The no form of this command will restore the hold time to the default value.

3) Configure ACL for PIM-SM6 neighbors

Command	Explanation
Interface Configuration Mode	

ipv6 pim neighbor-filter <access-list-name>	To configure ACL to filter PIM-SM6 neighbor. If session to the neighbor has been denied by ACL, then the sessions that have been set up will be discarded immediately and new sessions will not be set up.
no ipv6 pim neighbor-filter <access-list-name>	

4) Configure the interface as the boundary interface of the PIM-SM6 protocol

Command	Explanation
Interface Configuration Mode	
ipv6 pim bsr-border no ipv6 pim bsr-border	To configure the interface as the boundary of PIM-SM6 protocol. On the boundary interface, BSR messages will not be sent or received. The network connected the interface is considered as directly connected network. The no form of this command will remove the configuration.

5) Configure the interface as the management boundary of the PIM-SM6 protocol

Command	Explanation
Interface Configuration Mode	
ipv6 pim scope-border <500-599> <acl_name>	To configure PIM-SM6 management boundary for the interface and apply ACL for the management boundary. With default settings, ffx0::/13 is considered as the scope of the management group. If ACL is configured, then the scope specified by ACL permit command is the scope of the management group. acl_name should be standard IPv6 ACL name. The no form of this command will remove the configuration.
no ipv6 pim scope-border	

(2) Configure global PIM-SM6 parameter

1) Configure the switch as a candidate BSR

Command	Explanation
Global Configuration Mode	
ipv6 pim bsr-candidate {vlan <vlan_id> <ifname> tunnel <1-50>}[hash-mask-length] [priority]	This command is the global candidate BSR configuration command, which is used to configure the information of PIM-SM candidate BSR so that it can compete for BSR router with other candidate BSR. The no operation is to cancel the configuration of BSR.
no Ipv6 pim bsr-candidate {vlan <vlan_id> <ifname> tunnel <1-50>}[hash-mask-length] [priority]	

2) Configure the switch as a candidate RP

Command	Explanation
Global Configuration Mode	
ipv6 pim rp-candidate {vlan<vlan-id> loopback<index> <ifname>} [<group range>] [<priority>]	This command is the global candidate RP configuration command, which is used to configure the information of PIM-SM candidate RP so that it can compete for RP router with other

no ipv6 pim rp-candidate	candidate RP. The no operation is to cancel the configuration of RP.
---------------------------------	--

3) Configure static RP

Command	Explanation
Global Configuration Mode	
ipv6 pim rp-address <rp-address> [<group-range>] no ipv6 pim rp-address <rp-address> {all <group-range>}	To configure the address of the candidate RP. The no form of this command will remove the configuration for the candidate RP.

4) Configure the cache time of kernel multicast route

Command	Explanation
Global Configuration Mode	
ipv6 multicast unresolved-cache aging-time <value> no ipv6 multicast unresolved-cache aging-time	Configure the cache time of kernel multicast route, the no command restores the default value.

4. Disable PIM-SM protocol

Command	Explanation
Interface Configuration Mode	
no ipv6 pim sparse-mode	To disable the PIM-SM6 protocol.
Global Configuration Mode	
no ipv6 pim sparse-mode	To disable PIM-DM globally.

13.8.2.3 PIM-SM6 Typical Application

As shown in the following figure, add the Ethernet interfaces of SwitchA, SwitchB, SwitchC and SwitchD to corresponding VLAN, and start PIM-SM Protocol on each VLAN interface.

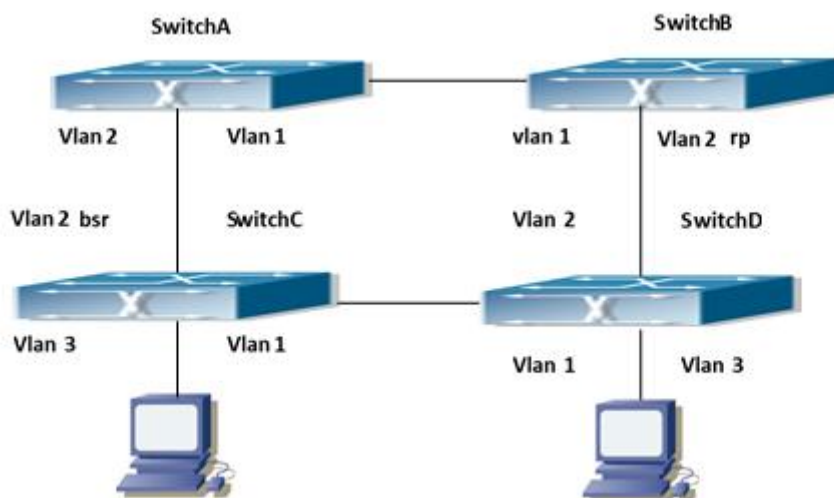

Figure 14- 10 PIM-SM Typical Environment

The configuration procedure for SwitchA, SwitchB, SwitchC and SwitchD is as below:

(1) Configure SwitchA:

```
Switch(config)#ipv6 pim multicast-routing
Switch(config)#interface vlan 1
Switch(Config-if-Vlan1)#ipv6 address 2000:12:1:1::1/64
Switch(Config-if-Vlan1)#ipv6 pim sparse-mode
Switch(Config-if-Vlan1)#exit
Switch(config)#interface vlan 2
Switch(Config-if-Vlan2)#ipv6 address 2000:13:1:1::1/64
Switch(Config-if-Vlan2)#ipv6 pim sparse-mode
```

(2) Configure Switch B:

```
Switch(config)#ipv6 pim multicast-routing
Switch(config)#interface vlan 1
Switch(Config-if-Vlan1)#ipv6 address 2000:12:1:1::2/64
Switch(Config-if-Vlan1)#ipv6 pim sparse-mode
Switch(Config-if-Vlan1)#exit
Switch(config)#interface vlan 2
Switch(Config-if-Vlan2)#ipv6 address2000:24:1:1::2/64
Switch(Config-if-Vlan2)#ipv6 pim sparse-mode
Switch(Config-if-Vlan2)#exit
Switch(config)#ipv6 pim rp-candidate vlan2
```

(3) Configure SwitchC:

```
Switch(config)#ipv6 pim multicast-routing
Switch(config)#interface vlan 1
Switch(Config-if-Vlan1)#ipv6 address 2000:34:1:1::3/64
Switch(Config-if-Vlan1)#ipv6 pim sparse-mode
Switch(Config-if-Vlan1)#exit
Switch(config)#interface vlan 2
Switch(Config-if-Vlan2)#ipv6 address 2000:13:1:1::3/64
Switch(Config-if-Vlan2)#ipv6 pim sparse-mode
Switch(Config-if-Vlan2)#exit
Switch(config)#interface vlan 3
Switch(Config-if-Vlan3)#ipv6 address 2000:30:1:1::1/64
Switch(Config-if-Vlan3)#ipv6 pim sparse-mode
Switch(Config-if-Vlan3)#exit
Switch(config)#ipv6 pim bsr-candidate vlan2 30 10
```

(4) Configure SwitchD:

```
Switch(config)#ipv6 pim multicast-routing
Switch(config)#interface vlan 1
Switch(Config-if-Vlan1)#ipv6 address 2000:34:1:1::4/64
Switch(Config-if-Vlan1)#ipv6 pim sparse-mode
Switch(Config-if-Vlan1)#exit
Switch(config)#interface vlan 2
Switch(Config-if-Vlan2)#ipv6 address 2000:24:1:1::4/64
```

```
Switch(Config-if-Vlan2)#ipv6 pim sparse-mode
Switch(Config-if-Vlan2)#exit
Switch(config)#interface vlan 3
Switch(Config-if-Vlan3)#ipv6 address 2000:40:1:1::1/64
Switch(Config-if-Vlan3)#ipv6 pim sparse-mode
```

13.8.2.4 PIM-SM6 Troubleshooting

When configuring and using PIM-SM protocol, PIM-SM protocol may fail to work normally due to physical connections, incorrect configuration and so on. So, users shall note the following points:

- ☞ Assure the physical connection is correct.
- ☞ Assure the Protocol of Interface and Link is UP (use show interface command);
- ☞ Unicast route shall be used to carry out RPF examination for multicast protocol. So the correctness of unicast route shall be guaranteed above all.
- ☞ PIM-SM Protocol requires supports of RP and BSR, therefore you should use show ipv6 pim bsr-router first to see if there is BSR information. If not, you need to check if there is unicast routing leading to BSR.
- ☞ Use show ipv6 pim rp-hash command to check if RP information is correct; if there is no RP information, you still need to check unicast routing;

If all attempts fail to solve the problems on PIM-SM, then use debug commands such as debug ipv6 pim/ debug ipv6 pim bsr, copy DEBUG information in 3 minutes and send to Technology Service Center.

13.8.3 ANYCAST RP v6

13.8.3.1 Introduction to ANYCAST RP v6

Anycast RP v6 is a technology based on PIM protocol, which provides redundancy in order to recover as soon as possible once an RP becomes unusable.

The kernel concept of Anycast RP v6 is that the RP addresses configured all over the whole network exist on multiple multicast servers (the most common situation is that every device providing ANYCAST RP uses LOOPBACK interface, and using the longest mask to configures RP addresses on this interface), while the unicast routing algorithm will make sure that PIM routers can always find the nearest RP, thus , providing a shorter and faster way to find RP in a larger network., Once an RP being used becomes unusable, the unicast routing algorithm will ensure that the PIM router can find a new RP path fast enough to recover the multicast server in time. Multiple RP will cause a new problem that is if the multicast source and the receivers are registered to different RP, some receivers will not be able to receive data of multicast source (obviously, the register messages only prefer the nearest RP). So, in order to keep the communication between all RP, Anycast RP defines that the nearest RP to the multicast source

should forward the source register messages to all the other RP to guarantee that all joiners of the RP can find the multicast source.

The method to realize the PIM-protocol-based Anycast RP is that: maintaining an ANYCAST RP list on every switch configured with Anycast RP and using another address as the label to identify each other. When one Anycast RP device receives a register message, it will send the register message to other Anycast RP devices while using its own address as the source address, to notify all the other devices of the original destination.

13.8.3.2 ANYCAST RP v6 Configuration Task

1. Enable ANYCAST RP v6 function
2. Configure ANYCAST RP v6

1. Enable ANYCAST RP v6 function

Command	Explanation
Global Configuration Mode	
ipv6 pim anycast-rp no ipv6 pim anycast-rp	Enable ANYCAST RP function. (necessary) The no operation will globally disable the ANYCAST RP function.

2. Configure ANYCAST RP v6

(1) Configure RP candidate

Command	Explanation
Global Configuration Mode	
ipv6 pim rp-candidate {vlan<vlan-id> loopback<index> <A:B::C:D> <priority>} no ipv6 pim rp-candidate	Now, the PIM-SM has allowed the Loopback interface to be a RP candidate.(necessary) Please pay attention to that, ANYCAST RP protocol can configure the Loopback interface or a regular three-layer VLAN interface to be the RP candidate. In make sure that PIM routers in the network can find where the RP locates, the RP candidate interface should be added into the router. No operation will cancel the RP candidate configured on this router.

(2) Configure self-rp-address (the RP communication address of this router)

Command	Explanation
Global Configuration Mode	
ipv6 pim anycast-rp self-rp-address A:B::C:D no ipv6 pim anycast-rp self-rp-address	Configure the self-rp-address of this router (as a RP). This address can be used to exclusively identify this router when communicating with other RP.(necessary) the effect of self-rp-address refers to two

	<p>respects:</p> <p>1 Once this router (as a RP) receives the register message from a DR unicast, it needs to forward the register message to all the other RP in the network, notifying them of the state of source (S,G). While forwarding the register message, this router will change the source address of it into self-rp-address.</p> <p>2 Once this router(as a RP) receives a register message from other RP unicast, such as a register message whose destination is the self-rp-address of this router, it will create (S,G) state and send back a register-terminating message, whose destination address is the source address of the register message.</p> <p>Pay attention: self-rp-address has to be the address of a three-layer interface on this router, but the configuration is allowed to be done with the absence of the interface. The self-rp-address should be unique.</p> <p>No operation will cancel the self-rp-address which is used to communicate with other RP by this router.</p>
--	--

(3) Configure other-rp-address (other RP communication addresses)

Command	Explanation
Global Configuration Mode	
<pre> ipv6 pim anycast-rp <anycast-rp-addr> <other-rp-addr> no ipv6 pim anycast-rp <anycast-rp-addr> <other-rp-addr> </pre>	<p>Configure anycast-rp-addr on this router (as a RP). This unicast address is actually the RP address configured on multiple RP in the network, in accordance with the address of RP candidate interface (or Loopback interface).</p> <p>The effect of anycast-rp-addr includes:</p> <p>1 Although more than one anycast-rp-addr addresses are allowed to be configured, only the one having the same address with the currently configured RP candidate address will take effect. Only after that, can the other-rp-address in accordance with this anycast-rp-addr take effect.</p> <p>2 The configuration is allowed to be done with the absence of the interface in accordance with the anycast-rp-addr.</p> <p>Configure on this router (as a RP) the other-rp-addresses of other RP communicating</p>

	<p>with it. This unicast address identifies other RP and is used in the communication with local routers.</p> <p>The effect of other-rp-address refers to two respects:</p> <ol style="list-style-type: none"> 1 Once this router (as a RP) receives the register message from a DR unicast, it should forward it to other RP in the network to notify all the RP in the network of the source (S.G) state. While forwarding, the router will change the destination address of the register message into other-rp-address. 2 Multiple other-rp-addresses can be configured in accordance with one anycast-rp-addr, Once the register message from a DR is received, it should be forwarded to all of this RP one by one. <p>No operation will cancel other-rp-address communicating with this router.</p>
--	---

13.8.3.3 ANYCAST RP v6 Configuration Examples

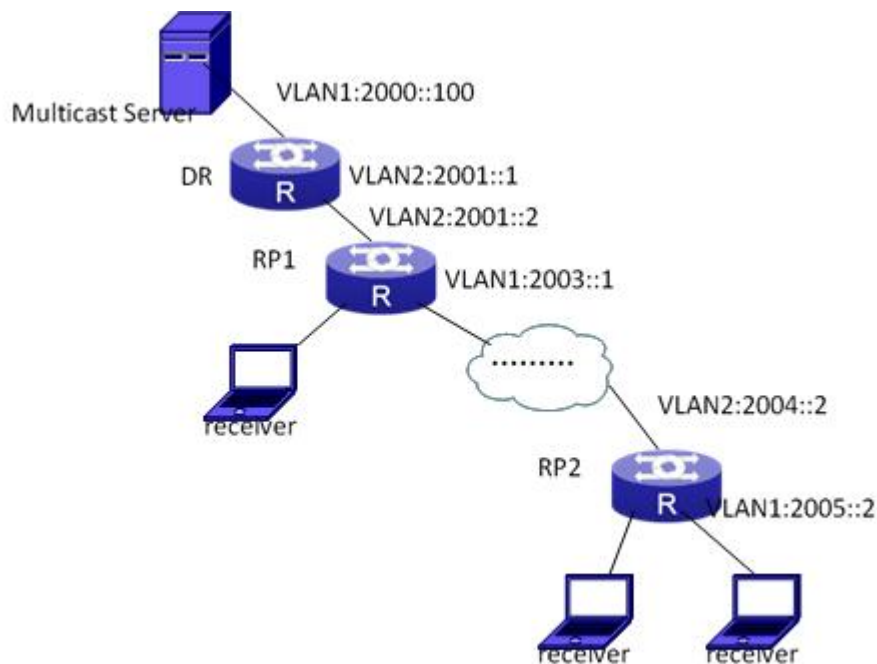

Figure 14- 11 The ANYCAST RP v6 function of a router

The following is the configuration steps:

RP1 Configuration:

```
Switch#config
```

```
Switch(config)#interface loopback 1
```

```
Switch(Config-if-Loopback1)#ipv6 address 2006::1/128
Switch(Config-if-Loopback1)#exit
Switch(config)#ipv6 pim rp-candidate loopback1
Switch(config)#ipv6 pim bsr-candidate vlan 1
Switch(config)#ipv6 pim multicast-routing
Switch(config)#ipv6 pim anycast-rp
Switch(config)#ipv6 pim anycast-rp self-rp-address 2003::1
Switch(config)#ipv6 pim anycast-rp 2006::1 2004::2
```

RP2 Configuration:

```
Switch#config
Switch(config)#interface loopback 1
Switch(Config-if-Loopback1)#ipv6 address 2006::1/128
Switch(Config-if-Loopback1)#exit
Switch(config)#ipv6 pim rp-candidate loopback1
Switch(config)#ipv6 pim multicast-routing
Switch(config)#ipv6 pim anycast-rp
Switch(config)#ipv6 pim anycast-rp self-rp-address 2004::2
Switch(config)#ipv6 pim anycast-rp 2006::1 2003::1
```

Please pay attention to that, for promulgating loopback interface router, if use MBGP4+ protocol, then can use network command; or use RIPng protocol, then can use route command.

13.8.3.4 ANYCAST RP v6 Troubleshooting

When configuring and using ANYCAST RP v6 function, the ANYCAST RP might work abnormally because of faults in physical connections, configurations or something others. So, the users should pay attention to the following points:

- ☞ The physical connections should be guaranteed to be correct
- ☞ The PIM-SM6 protocol should be guaranteed to operate normally
- ☞ The ANYCAST RP should be guaranteed to be enabled in Global configuration mode
- ☞ The self-rp-address should be guaranteed to be configured correctly in Global configuration mode
- ☞ The other-rp-address should be guaranteed to be configured correctly in Global configuration mode
- ☞ All the interface routers should be guaranteed to be correctly added, including the loopback interface as a RP
- ☞ Use “**show ipv6 pim anycast rp status**” command to check whether the configuration information of ANYCAST RP is correct

If the problems of ANYCAST still cannot be solved after checking, please use debug commands like “debug ipv6 pim anycast-rp”, then copy the DEBUG information within three minutes and send it to the technical service center of our company.

13.8.4 PIM-SSM6

13.8.4.1 Introduction to PIM-SSM6

Source Specific Multicast (PIM-SSM6) is a new kind of multicast service protocol. With PIM-SSM6, a multicast session is distinguished by the multicast group address and multicast source address. In SSM6, hosts can be added into the multicast group manually and efficiently like the traditional PIM-SM6, but leave out the shared tree and RP management in PIM-S6M. In SSM6, SPT tree will be constructed with (S,G). G for the multicast group address and S for the source address of the multicast which sends datagram to G. (S,G) in a pair is named as a channel of SSM6. SSM6 serves best for the application of multicast service which is from one station to many ones, for example, the network sports video channel, and the news channel. By default, the multicast group address of SSM6 is limited to ff3x::/32. However this address range can be extended according to actual situations.

PIM-SSM6 can be supported in the PIM-DM6 environment.

13.8.4.2 PIM-SSM6 Configuration Task List

Command	Explanation
Global configuration mode	
ipv6 pim ssm {default range <access-list-number>} no ipv6 pim ssm	To configure address range for pim-ssm multicast group. The no prefix will disable this command.

13.8.4.3 PIM-SSM6 Configuration Example

As it is shown in the below figure, ethernet interfaces of switchA, switchB, switchC, and switchD are separated into different vlan. And PIM-SM6 or PIM-DM6 is enabled on all the vlan interfaces. Take configuration of PIM-SM6 for example.

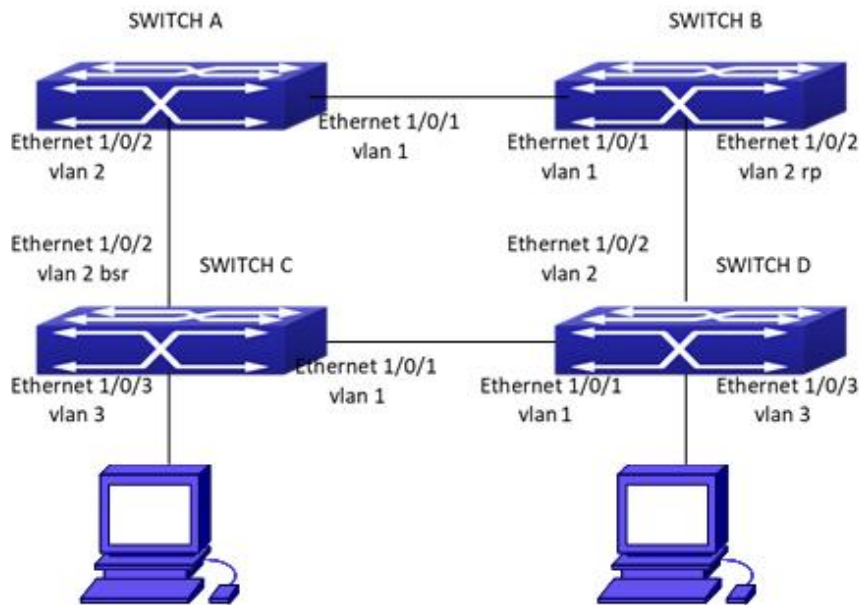

Figure 14- 12 PIM-SSM typical environment

Configurations of switchA , switchB, switchC and switchD are listed as below:

(1) Configuration of switchA:

```
Switch(config)#ipv6 pim multicast-routing
Switch(config)#interface vlan 1
Switch(Config-If-Vlan1)# ipv6 address 2000:12:1:1::1/64
Switch(Config-If-Vlan1)# ipv6 pim sparse-mode
Switch(Config-If-Vlan1)#exit
Switch(config)#interface vlan 2
Switch(Config-If-Vlan2)# ipv6 address 2000:13:1:1::1/64
Switch(Config-If-Vlan2)# ipv6 pim sparse-mode
Switch(Config-If-Vlan2)#exit
Switch(config)#ipv6 access-list 500 permit ffl:e::1/64
Switch(config)#ip pim ssm range 500
```

(2) Configuration of switchB:

```
Switch(config)#ipv6 pim multicast-routing
Switch(config)#interface vlan 1
Switch(Config-If-Vlan1)# ipv6 address 2000:12:1:1::2/64
Switch(Config-If-Vlan1)# ipv6 pim sparse-mode
Switch(Config-If-Vlan1)#exit
Switch(config)#interface vlan 2
Switch(Config-If-Vlan2)# ipv6 address 2000:24:1:1::2/64
Switch(Config-If-Vlan2)# ipv6 pim sparse-mode
Switch(Config-If-Vlan2)# exit
Switch(config)# ipv6 pim rp-candidate vlan2
Switch(config)#ipv6 access-list 500 permit ffl:e::1/64
```



```
Switch(config)#ip pim ssm range 500
```

(3) Configuration of SwitchC:

```
Switch(config)#ipv6 pim multicast-routing
Switch(config)#interface vlan 1
Switch(Config-If-Vlan1)# ipv6 address 2000:34:1:1::3/64
Switch(Config-If-Vlan1)# ipv6 pim sparse-mode
Switch(Config-If-Vlan1)#exit
Switch(config)#interface vlan 2
Switch(Config-If-Vlan2)# ipv6 address 2000:13:1:1::3/64
Switch(Config-If-Vlan2)# ipv6 pim sparse-mode
Switch(Config-If-Vlan2)#exit
Switch(config)#interface vlan 3
Switch(Config-If-Vlan3)# ipv6 address 2000:30:1:1::1/64
Switch(Config-If-Vlan3)# ipv6 pim sparse-mode
Switch(Config-If-Vlan3)# exit
Switch(config)# ipv6 pim bsr-candidate vlan2 30 10
Switch(config)#ipv6 access-list 500 permit ffl::1/64
Switch(config)#ip pim ssm range 500
```

(4) Configuration of SwitchD:

```
Switch(config)#ipv6 pim multicast-routing
Switch(config)#interface vlan 1
Switch(Config-If-Vlan1)# ipv6 address 2000:34:1:1::4/64
Switch(Config-If-Vlan1)# ipv6 pim sparse-mode
Switch(Config-If-Vlan1)#exit
Switch(config)#interface vlan 2
Switch(Config-If-Vlan2)# ipv6 address 2000:24:1:1::4/64
Switch(Config-If-Vlan2)# ipv6 pim sparse-mode
Switch(Config-If-Vlan2)#exit
Switch(config)#interface vlan 3
Switch(Config-If-Vlan3)# ipv6 address 2000:40:1:1::1/64
Switch(Config-If-Vlan3)# ipv6 pim sparse-mode
Switch(Config-If-Vlan3)#exit
Switch(config)#ipv6 access-list 500 permit ffl::1/64
Switch(config)#ip pim ssm range 500
```

13.8.4.4 PIM-SSM6 Troubleshooting

When configuring the PIM-SSM6 protocol, it may fail to work because of the failure of physical connection or the mis-configurations. To debug these errors, attention should be paid to the following lists.

- ☞ Make sure the physical links are connected correctly.
- ☞ Make sure the state of the data link layer has become UP. (Use show interface command).

- ☞ Make sure PIM6 is enabled in global configuration mode (Refer to the command `ipv6 pim multicast-routing`).
- ☞ Make sure PIM-SM6 is configured on the interface (Refer to the command `ipv6 pim sparse-mode`)
- ☞ Make sure SSM6 is configure in global configuration mode.
- ☞ The multicast protocol uses the unicast routing to make RPF check. Hence, single-cast routing should be verified firstly.

If problems could not be fixed with the above check list, please enable the command of **debug ipv6 pim event and debug ipv6 pim packet**, and save the debug information for 3 minutes, and send it to Technology Service Center.

13.8.5 IPv6 DCSCM

13.8.5.1 Introduction to IPv6 DCSCM

The technology of IPv6 DCSCM (Destination Control and Source Control Multicast) includes three aspects: the multicast source control, the multicast user control and the service-priority-oriented policy multicast.

IPv6 DCSCM Controllable Multicast technology proceeds as the following way:

1. If source controlled multicast is configured on the edge switches, only the multicast data of the specified group from the specified source can pass.
2. The RP switches which are the core of PIM-SM will directly send REGISTER_STOP as response to the REGISTER messages not from the specified source and specified group, and no entry is allowed to be created. (This task is implemented in the PIM-SM module).

The control of multicast users of IPv6 DCSCM technology is implemented on the basis of controlling the MLD message sent from the users, so the control module is MLD snooping and the MLD module, the control logic of which includes the following three methods: controlling according to the VLAN+MAC sending the message, controlling according to the IP address sending the message, and controlling according to the input port of the message. MLD snooping can adopt all the three methods at the same time, while the MLD module, at the third layer, can only control the IP address sending the message.

The service-priority-oriented policy multicast of IPv6 DCSCM technology adopts the following method: for the confined multicast data, the user-specified priority will be set at the access point, enabling the data can be sent at a higher priority through TRUNK, and guaranteeing that the data can be sent through the whole net at the user-specified priority.

13.8.5.2 IPv6 DCSCM Configuration Task Sequence

1. The source control configuration
2. The destination control configuration
3. The multicast policy configuration

1. The source control configuration

The source control configuration has three steps, first is globally enabling the source control, the following is the command of globally enabling the source control:

Command	Explanation
Global Configuration Mode	
ipv6 multicast source-control(necessary) no ipv6 multicast source-control	Globally enable the source control, the no operation of this command will globally disable the source control. What should be paid attention to is that, once globally enable the source control, all the multicast messages will be dropped by default. All the source control configurations can only be done after globally enabled, and only when all the configured rules are disabled, the source control can be disabled globally.

The next is configuring the source control rules, which adopts the same method as configuring ACL, using ACL number from 8000 to 8099, while each rule number can configure 10 rules. What should be paid attention to is that these rules have orders, the earliest configured rule is at the front. Once a rule is matched, the following ones will not take effect, so the globally enabled rules should be the last to configure. The following is the command:

Command	Explanation
Global Configuration Mode	
[no] ipv6 access-list <8000-8099> {deny permit} {{<source/M>}{host-source <source-host-ip>}{any-source} {{<destination/M> }{host-destination <destination-host-ip>}{any-destination}	Used to configure the source control rules, the rules can only take effect when applied to the specified port. The no operation of this command can delete the specified rule.

The last is to configure the rules to the specified port.

Pay attention: since the configured rules will take up entries of hardware, configuring too many rules might cause failure if the underlying entries are full, so it is recommended that users adopt rules as simple as possible. The following is the configuration command:

Command	Explanation
Port Configuration Mode	
[no] ipv6 multicast source-control access-group <8000-8099>	Used to configure the source control rule to a port, the no operation will cancel this configuration.

2. The configuration of destination control

The configuration of destination control is similar to that of source control, and also has three steps:

First, globally enable the destination control, since destination control needs to avoid the

unauthorized users from receiving multicast data, once it is enabled globally, the switch will stop broadcasting received multicast data, so if a switch has enabled destination control, users should not connect two or more other Layer three switches within the same VLAN where it locates. The following is the configuration command:

Command	Explanation
Global Configuration Mode	
multicast destination-control(necessary)	Globally enable IPV4 and IPv6 destination control, the no operation of this command will globally disable destination control. All of the other configuration can only take effect after globally enabled.

The next is configuring destination control rules, which are similar to that of source control, but using ACL number from 9000 to 10099 instead.

Command	Explanation
Global Configuration Mode	
[no] ipv6 access-list <9000-10099> {deny permit} {{<source/M>}}{host-source <source-host-ip>} any-source} {{<destination/M>}}{host-destination <destination-host-ip>} any-destination}	Used to configure destination control rules, these rules can only take effect when applied to specified source IP, VLAN-MAC or port. The no operation of this rule will delete the specified rule.

The last step is to configure the rules to the specified source IP, source VLAN MAC or the specified port. What should be paid attention to is that only when the MLD-SNOOPING is enabled, these rules can be globally used, or, only rules of source IP can be used in MLD protocol.

The following is the configuration command:

Command	Explanation
Port Mode	
[no] ipv6 multicast destination-control access-group <9000-10099>	Used to configure the destination control rule to a port, the no operation of this command will cancel the configuration.
Global Configuration Mode	
[no] ipv6 multicast destination-control <1-4094> <macaddr> access-group <9000-10099>	Used to configure the destination control rules to the specified VLAN-MAC, the no operation of this command will cancel the configuration.
[no] ipv6 multicast destination-control <IPADDRESS/M> access-group <9000-10099>	Used to configure the destination control rules to the specified source IPv6 address/MASK, the no operation of this command will cancel the configuration.

3. The configuration of multicast policy

The multicast policy adopts the method of specifying a priority for the specified multicast data to meet the user's particular demand, what should be paid attention to is that only when

multicast data is transmitted in TRUNK, can it be taken special care of. The configuration is quite simple, for only one command is needed, that is set priority for the specified multicast, the following is the command:

Command	Explanation
Global Configuration Mode	
[no] ipv6 multicast policy <IPADDRESS/M> <IPADDRESS/M> cos <priority>	Configure multicast policy, set priority for sources and groups in a specified range, the priority valid range is 0 to 7.

13.8.5.3 IPv6 DCSCM Typical Examples

1. Source control

In order to prevent an edge switch sends multicast data at will, we configure on the edge switch that only the switch whose port is Ethernet1/0/4 can send multicast data, and the group of data should be ff1e::1. The uplink port Ethernet1/0/25 can forward multicast data without being restricted, so we can configure as follows.

```
Switch(config)#ipv6 access-list 8000 permit any-source ff1e::1
Switch(config)#ipv6 access-list 8001 permit any any
Switch(config)#ipv6 multicast source-control
Switch(config)#interface Ethernet1/0/4
Switch(Config-If-Ethernet1/0/4)#ipv6 multicast source-control access-group 8000
Switch(config)#interface Ethernet1/0/25
Switch(Config-If-Ethernet1/0/25)#ipv6 multicast source-control access-group 8001
```

2. Destination control

We want to confine that the users of the segment whose address is fe80::203:fff:fe01:228a/64 can not join the ff1e::1/64 group, so we can configure as follows:

First, enable MLD Snooping in the VLAN where it locates (in this example, it is VLAN2).

```
Switch(config)#ipv6 mld snooping
Switch(config)#ipv6 mld snooping vlan 2
```

Then configure relative destination control access list and configure specified IPv6 address to use this access list.

```
Switch(config)#ipv6 access-list 9000 deny any ff1e::1/64
Switch(config)#ipv6 access-list 9000 permit any any
Switch(config)#multicast destination-control
Switch(config)#ipv6 multicast destination-control fe80::203:fff:fe01:228a/64 access-group 9000
```

Thus, the users of this segment can only join groups other than 2ff1e::1/64.

3. Multicast policy

Server 2008::1 is sending important multicast data in group ff1e::1, we can configure on its access switch as follows:

```
Switch(config)#ipv6 multicast policy 2008::1/128 ff1e::1/128 cos 4
```

Thus this multicast flow will have a priority of 4, when it passes the TRUNK port of this switch to another switch (generally speaking, it is a relatively high priority, the data with higher priority might be protocol data, if a higher priority is set, when there is too much multicast data, the switch protocol might operate abnormally).

13.8.5.4 IPv6 DCSCM Troubleshooting

IPv6 DCSCM module acts like ACL, so most problems are caused by improper configuration. Please read the instructions above carefully.

13.8.6 MLD

13.8.6.1 Introduction to MLD

MLD (Multicast Listener Discovery) is the multicast group member (receiver) discovery protocol serving IPv6 multicast. It is similar to IGMP Protocol in IPv4 multicast application. Correspondingly, MLD Protocol version1 is similar to IGMP Protocol version2, and MLD Protocol version2 is similar to IGMP Protocol version3. Current firmware supports MLDv1/MLDv2.

The IPv6 multicast hosts can join or leave from multicast group at any location, any time, regardless of the total number of group members. It is unnecessary and impossible for multicast switch to store the relationship among all host members. Multicast switch simply finds out via MLD protocol if there are receivers of certain multicast group on the network segment connected to each port. The only thing host need to do is to keep the record of which multicast groups it joined.

MLD is unsymmetrical between host and switch: the host needs to respond the MLD query message of multicast switch with membership report message; the switch periodically sends membership query message and determines if there is host joining a specific group in its subnetworks according to the response message received, and after it receives the report of a host quitting from the group, it sends out the query for the group to confirm if there is no member left in it.

There are three types of protocol messages of MLD Protocol, that is, Query, Report and Done (which is corresponding to Leave of IGMPv2). Like IGMPV2, the Query messages include General Query and Specific Group Query. General Query uses the multicast address FF02::1 of hosts as destination address, the group address is 0; and Specific Group Query use its group address as destination address. The multicast addresses of MLD use 130, 131 and 132 as data types denoting the three kinds of messages mentioned above. Other logic is basically same as IGMPv2.

MLD protocol version2 use FF02::16 as destination address of membership report, and 143 as data type. The other logic of MLD Protocol version2 is similar to IGMP Protocol version3.

13.8.6.2 MLD Configuration Task List

- 1、 Start MLD (Required)
- 2、 Configure MLD auxiliary parameters (Required)
 - (1) Configure MLD group parameters

- 1) Configure MLD group filter conditions
- (2) Configure MLD query parameters
 - 1) Configure the interval of MLD sending query message
 - 2) Configure the maximum response time of MLD query
 - 3) Configure overtime of MLD query

3、 Shut down MLD Protocol

1. Start MLD Protocol

There is no special command for starting MLD Protocol on EDGECORE series layer 3 switches. MLD Protocol will automatically start up as long as any IPv6 multicast protocol is started on corresponding interface.

Command	Explanation
Global Mode	
Ipv6 pim multicast-routing	To start Global IPv6 Multicast Protocol, the precondition of starting MLD Protocol. The NO operation of corresponding command shuts ipv6 multicast protocol and MLD Protocol. (Required)

Command	Explanation
Port Configuration Mode	
ipv6 pim dense-mode ipv6 pim sparse-mode	Start MLD Protocol. The NO operation of corresponding command shuts MLD Protocol. (Required)

2. Configure MLD auxiliary parameters

(1) Configure MLD group parameters

- 1) Configure MLD group filter conditions

Command	Explanation
Port Configuration Mode	
ipv6 mld access-group <acl_name> no ipv6 mld access-group	Configure the filter conditions of interface for MLD group; the NO operation of this command cancels filter conditions.

(2) Configure MLD Query parameters

- 1) Configure interval time for MLD to send query messages
- 2) Configure the maximum response time of MLD query
- 3) Configure the overtime of MLD query

Command	Explanation
Port Configuration Mode	
ipv6 mld query-interval <time_val> no ipv6 mld query-interval	Configure the interval of MLD query messages sent periodically; the NO operation of this command restores the default value.
ipv6 mld query-max-response-time <time_val>	Configure the maximum response time of the interface for MLD query; the NO operation of this

no ipv6 mld query-max-response-time	mld	command restores the default value.
ipv6 mld query-timeout <time_val> no ipv6 mld query-timeout		Configure the overtime of the interface for MLD query; the NO operation of this command restores the default value.

3. Shut down MLD Protocol

Command	Explanation
Port Configuration Mode	
no ipv6 pim dense-mode no ipv6 pim sparse-mode no ipv6 pim multicast-routing (Global Mode)	Shut down MLD Protocol

13.8.6.3 MLD Typical Application

As shown in the following figure, add the Ethernet interfaces of Switch A and Switch B to corresponding vlan, and start PIM6 on each vlan interface.

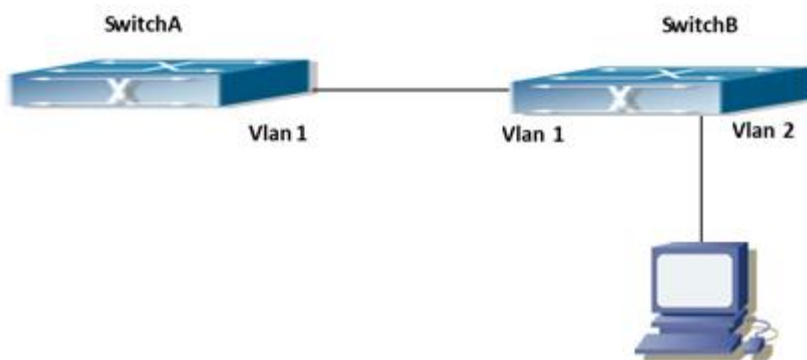

Figure 14- 13 Network Topology Diagram

The configuration procedure for SwitchA and SwitchB is as below:

(1) Configure SwitchA:

```
Switch (config) #ipv6 pim multicast-routing
Switch (config) #ipv6 pim rp-address 3FFE::1
Switch (config) #interface vlan 1
Switch (Config-if-Vlan1) #ipv6 address 3FFE::1/64
Switch (Config-if-Vlan1) #ipv6 pim sparse-mode
```

(2) Configure SwitchB:

```
Switch (config) #ipv6 pim multicast-routing
Switch (config) #ipv6 pim rp-address 3FFE::1
Switch (config) #interface vlan1
Switch (Config-if-Vlan1) #ipv6 address 3FFE::2/64
Switch (Config-if-Vlan1) #ipv6 pim sparse-mode
Switch (Config-if-Vlan1) #exit
Switch (config) #interface vlan2
Switch (Config-if-Vlan2) #ipv6 address 3FFA::1/64
Switch (Config-if-Vlan2) #ipv6 pim sparse-mode
```

Switch (Config-if-Vlan2) #ipv6 mld query-timeout 150

13.8.6.4 MLD Troubleshooting Help

When configuring and using MLD protocol, MLD protocol may fail to work normally due to physical connections, incorrect configuration and so on. So, users shall note the following points:

- ☞ Assure the physical connection is correct.
- ☞ Assure the protocol of interface and link is UP (use show interface command)
- ☞ Assure to start one kind of multicast protocol on the interface
- ☞ Assure the time of the timers of each router on the same network segment is consistent; usually we recommend the default setting.
- ☞ Unicast route shall be used to carry out RPF examination for multicast protocol. So the correctness of unicast route shall be guaranteed above all.

If all attempts fail to solve the problems on MLD, please use debug commands such as debug ipv6 mld event/packet, and copy DEBUG information in 3 minutes and send to Technology Service Center.

13.8.7 MLD Snooping

13.8.7.1 Introduction to MLD Snooping

MLD, the Multicast Listener Discovery Protocol, is used to realize multicasting in the IPv6. MLD is used by the network equipments such as routers which supports multicast for multicast listener discovery, also used by listeners looking forward to join certain multicast group informing the router to receive data packets from certain multicast address, all of which are done through MLD message exchange. First the router send an MLD Multicast listener Query message through a multicast address which can address all the listeners (namely ff02::1). Once there is a listener who wishes to join the multicast address, it will send a MLD Multicast listener Report back through the multicast address.

MLD Snooping is namely the MLD listening. The switch restricts the multicast traffic from flooding through MLD Snooping, and forward the multicast traffic to ports associated to multicast devices only. The switch listens to the MLD messages between multicast routers and listeners, and maintains the multicast group forwarding list based on the listening result. The switches forwards multicast packets according to the multicast forwarding list

The switch realizes the MLD Snooping function while supporting MLD v2. This way, the user can acquire IPv6 multicast with the switch.

13.8.7.2 MLD Snooping Configuration Task

1. Enable the MLD Snooping function
2. Configure the MLD Snooping

1. Enable the MLD Snooping function

Command	Explanation
Global Mode	
ipv6 mld snooping no ipv6 mld snooping	Enable global MLD Snooping, the “ no ipv6 mld snooping ” command disables the global MLD snooping.

2. Configure MLD Snooping

Command	Explanation
Global Mode	
ipv6 mld snooping vlan <vlan-id> no ipv6 mld snooping vlan <vlan-id>	Enable MLD Snooping on specific VLAN. The “no” form of this command disables MLD Snooping on specific VLAN.
ipv6 mld snooping vlan <vlan-id> limit {group <g_limit> source <s_limit>} no ipv6 mld snooping vlan <vlan-id> limit	Configure the number of the groups in which the MLD Snooping can join, and the maximum number of sources in each group. The “no” form of this command restores to the default.
ipv6 mld snooping vlan <vlan-id> l2-general-querier no ipv6 mld snooping vlan <vlan-id> l2-general-querier	Set the VLAN level 2 general querier, which is recommended on each segment. The “no” form of this command cancels the level 2 general querier configuration.
ipv6 mld snooping vlan <vlan-id> mrouter-port interface <interface -name> no ipv6 mld snooping vlan <vlan-id> mrouter-port interface <interface -name>	Configure the static mrouter port in specific vlan. The “no” form of this command cancels the mrouter port configuration.
ipv6 mld snooping vlan <vlan-id> mrouter-port learnpim6 no ipv6 mld snooping vlan <vlan-id> mrouter-port learnpim6	Enable the function that the specified VLAN learns mrouter-port (according to pimv6 packets), the no command will disable the function.
ipv6 mld snooping vlan <vlan-id> mrpt <value> no ipv6 mld snooping vlan <vlan-id> mrpt	Configure the keep-alive time of the mrouter port. The “no” form of this command restores to the default.
ipv6 mld snooping vlan <vlan-id> query-interval <value> no ipv6 mld snooping vlan <vlan-id> query-interval	Configure the query interval. The “no” form of this command restores to the default.
ipv6 mld snooping vlan <vlan-id> immediate-leave no ipv6 mld snooping vlan <vlan-id> immediate-leave	Configure immediate leave multicast group function for the MLD Snooping of specific VLAN. The “no” form of this command cancels the immediate leave configuration.
ipv6 mld snooping vlan <vlan-id> query-mrsp <value> no ipv6 mld snooping vlan <vlan-id> query-mrsp	Configure the query maximum response period. The “no” form of this command restores to the default.

<pre> ipv6 mld snooping vlan <vlan-id> query-robustness <value> no ipv6 mld snooping vlan <vlan-id> query-robustness </pre>	Configure the query robustness, the “no” form of this command restores to the default.
<pre> ipv6 mld snooping vlan <vlan-id> suppression-query-time <value> no ipv6 mld snooping vlan <vlan-id> suppression-query-time </pre>	Configure the suppression query time. The “no” form of this command restores to the default
<pre> Ipv6 mld snooping vlan <vlan-id> static-group <X:X::X:X> [source <X:X::X:X>] interface [ethernet port-channel] <IFNAME> no ipv6 mld snooping vlan <vlan-id> static-group <X:X::X:X> [source <X:X::X:X>] interface [ethernet port-channel] <IFNAME> </pre>	Configure static-group on specified port of the VLAN. The no form of the command cancels this configuration.

13.8.7.3 MLD Snooping Examples

Scenario 1: MLD Snooping Function

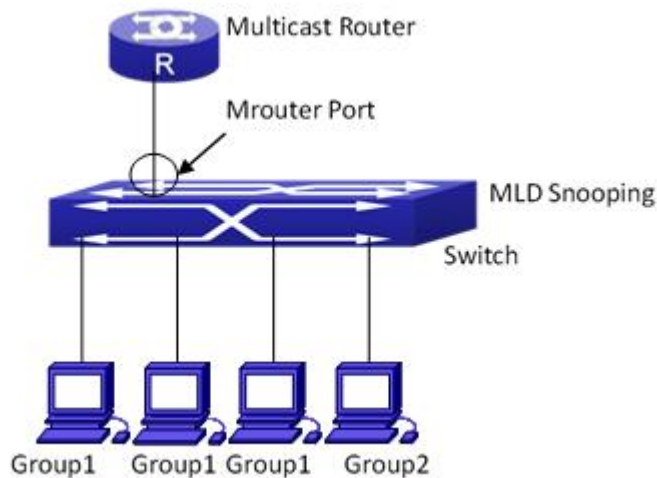

Figure 14- 14 Open the switch MLD Snooping Function figure

As shown above, the vlan 100 configured on the switch consists of ports 1, 2, 6, 10 and 12. Four hosts are respectively connected to 2, 6, 10 and 12 while the multicast router on port 1. Suppose we need MLD Snooping on VLAN 100, however by default, the global MLD Snooping as well as the MLD Snooping on each VLAN are, therefore first we have to enable the global MLD Snooping at the same time enable the MLD Snooping on VLAN 100, furthermore we need to set the port 1 of VLAN 100 as a mrouter port.

Configuration procedure is as follows.

```
Switch#config
```

```
Switch(config)#ipv6 mld snooping
```

```
Switch(config)#ipv6 mld snooping vlan 100
```

```
Switch(config)#ipv6 mld snooping vlan 100 mrouter-port interface ethernet 1/0/1
```

Multicast configuration:

Assume there are two multicast servers: the Multicast Server 1 and the Multicast Server 2, amongst program 1 and 2 are supplied on the Multicast Server 1 while program 3 on the Multicast server 2, using group addresses respectively the Group 1, Group 2 and Group 3. Concurrently multicast application is operating on the four hosts. Two hosts connected to port 2, 6 are playing program 1 while the host connected to port 10 playing program 2, and the one to port 12 playing program 3.

MLD Snooping interception results:

The multicast table on vlan 100 shows: port 1, 2, 6 are in (Multicasting Server 1, Group1), port 1, 10 are in (Multicasting Server 1, Group2), and port 1, 12, 12 are in (Multicasting Server 2, Group3)

All the four hosts successfully receive programs they are interested in. port 2, 6 receives no traffic from program 2 and 3; port 10 receives no traffic from program 1 and 3, and port 12 receives no traffic from program 1 and 2.

Scenario 2: MLD L2-general-querier

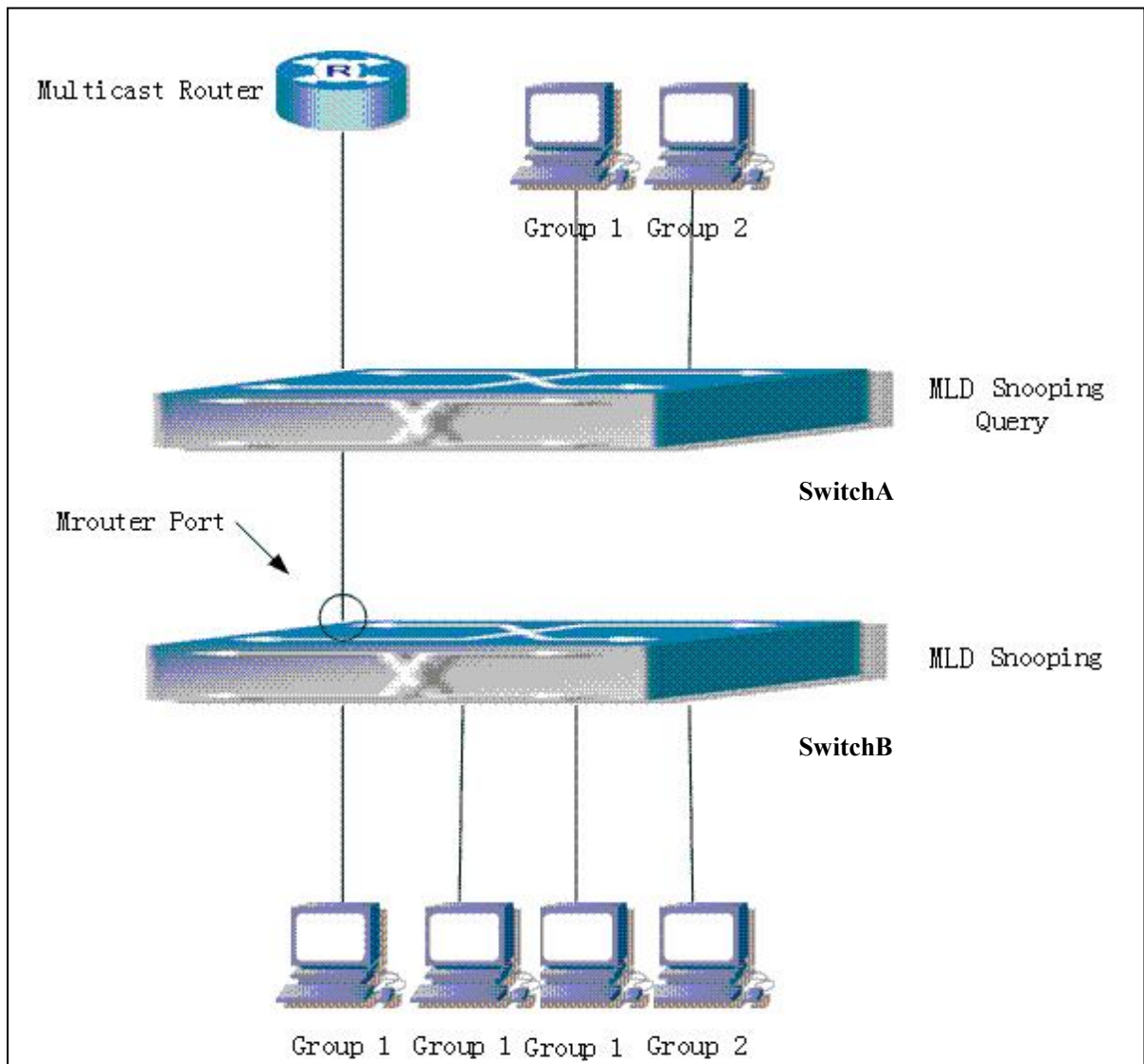

Figure 14- 15 Switch as MLD Querier Function figure

Configuration of switch B is the same as the switches in case 1, and here the switch 1 replaces the Multicast Router in case 1. Assume the vlan 60 configured on it contains port 1, 2, 10 and 12, amongst port 1 is connected to multicast server, port 2 to switch2. To send Query periodically, global MLD Snooping has to be enabled while executing the mld snooping vlan 60 l2-general-querier, setting the vlan 60 to a Level 2 General Querier.

Configuration procedure is as follows:

```
SwitchA#config
```

```
SwitchA(config)#ipv6 mld snooping
```

```
SwitchA(config)#ipv6 mld snooping vlan 60
```

```
SwitchA(config)#ipv6 mld snooping vlan 60 l2-general-querier
```

```
SwitchB#config
```

```
SwitchB(config)#ipv6 mld snooping
```

```
SwitchB(config)#ipv6 mld snooping vlan 100
```

```
SwitchB(config)#ipv6 mld snooping vlan 100 mrouter interface ethernet 1/0/1
```

Multicast configuration:

Same as scenario 1

MLD Snooping interception results:

Same as scenario 1

Scenario 3: To run in cooperation with layer 3 multicast protocols

SWITCH which is used in Scenario 1 is replaced with ROUTER with specific configurations remains the same. And multicast and IGMP snooping configurations are the same with what it is in Scenario 1. To configure PIM-SM6 on ROUTER, and enable PIM-SM6 on vlan 100 (use the same PIM mode with the connected multicast router)

The configurations are listed as below:

```
switch#config
```

```
switch(config)#ipv6 pim multicast-routing
```

```
switch(config)#interface vlan 100
```

```
switch(config-if-vlan100)#ipv6 pim sparse-mode
```

MLD snooping does not distribute entries when layer 3 multicast protocol is enabled. It only does the following tasks.

- To remove the layer 2 multicast entries.
- To provide query functions to the layer 3 with vlan, S, and G as the parameters.
- When layer 3 MLD is disabled, re-enable distributing layer 2 multicast entries.

By looking up the layer 3 IP6MC entries, it can be found that ports can be indicated by the layer 3 multicast entries. This ensures the MLD Snooping can work in cooperation with the layer 3 multicast protocols.

13.8.7.4 MLD Snooping Troubleshooting

In configuring and using MLD Snooping, the MLD Snooping server may fail to run properly

due to physical connection failure, wrong configuration, etc. The user should ensure the following:

- 👉 Ensure the physical connection is correct
- 👉 Ensure the MLD Snooping is enabled under global mode (using `ipv6 mld snooping`)
- 👉 Ensure the MLD Snooping is configured on the vlan under global mode (using `ipv6 mld snooping vlan <vlan-id>`)
- 👉 Ensure there is a vlan configured as a L2 general querier, or there is a static mrouter configured in a segment,
- 👉 Use command to check if the MLD snooping information is correct

13.9 IPv6 Security RA

13.9.1 Introduction to IPv6 Security RA

In IPv6 networks, the network topology is generally compromised of routers, layer-two switches and IPv6 hosts. Routers usually advertise RA, including link prefix, link MTU and other information, when the IPv6 hosts receive RA, they will create link address, and set the default router as the one sending RA in order to implement IPv6 network communication. If a vicious IPv6 host sends RA to cause that normal IPv6 users set the default router as the vicious IPv6 host user, the vicious user will be able to capture the information of other users, which will threat the network security. Simultaneously, the normal users get incorrect address and will not be able to connect to the network. So, in order to implement the security RA function, configuring on the switch ports to reject vicious RA messages is necessary, thus to prevent forwarding vicious RA to a certain extent and to avoid affecting the normal operation of the network.

13.9.2 IPv6 Security RA Configuration Task Sequence

1. Globally enable IPv6 security RA
2. Enable IPv6 security RA on a port
3. Display and debug the relative information of IPv6 security RA

1. Globally enable IPv6 security RA

Command	Explanation
Global Configuration Mode	
ipv6 security-ra enable no ipv6 security-ra enable	Globally enable and disable IPv6 security RA.

2. Enable IPv6 security RA on a port

Command	Explanation
Port Configuration Mode	
ipv6 security-ra enable no ipv6 security-ra enable	Enable and disable IPv6 security RA in port configuration mode.

3. Display and debug the relative information of IPv6 security RA

Command	Explanation
Admin Mode	
debug ipv6 security-ra no debug ipv6 security-ra	Enable the debug information of IPv6 security RA module, the no operation of this command will disable the output of debug information of IPv6 security RA.

<code>show ipv6 security-ra [interface <interface-list>]</code>	Display the distrust port and whether globally security RA is enabled.
---	--

13.9.3 IPv6 Security RA Typical Examples

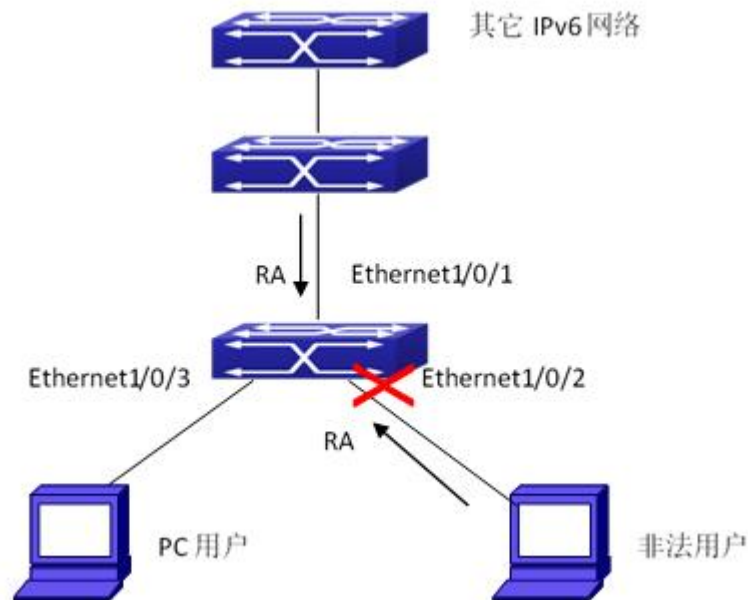

Figure 14- 16 IPv6 Security RA sketch map

Instructions: if the illegal user in the graph advertises RA, the normal user will receive the RA, set the default router as the vicious IPv6 host user and change its own address. This will cause the normal user to not be able to connect the network. We want to set security RA on the 1/0/2 port of the switch, so that the RA from the illegal user will not affect the normal user.

Switch configuration task sequence:

```
Switch#config
```

```
Switch(config)#ipv6 security-ra enable
```

```
Switch(Config-If-Ethernet1/0/2)# ipv6 security-ra enable
```

13.9.4 IPv6 Security RA Troubleshooting Help

The function of IPv6 security RA is quite simple, if the function does not meet the expectation after configuring IPv6 security RA:

- ☞ Check if the switch is correctly configured.
- ☞ Check if there are rules conflicting with security RA function configured on the switch, this kind of rules will cause RA messages to be forwarded.

13.10 SAVI Configuration

13.10.1 Introduction to SAVI

SAVI (Source Address Validation Improvement) is a security authentication method that provides the granularity level of the node source address. It gets the trust node information (such as port, MAC address information), namely, anchor information by monitoring the interaction process of the relative protocol packets (such as ND protocol, DHCPv6 protocol) and using CPS (Control Packet Snooping) mechanism. After that, it binds the anchor information with the node source address and sends the corresponding filter rules, allow the packets which match the filter rules to pass only, so as to reach the aim that check the validity of node source address.

SAVI function includes ND Snooping function, DHCPv6 Snooping function and RA Snooping according to the protocol packet type. ND Snooping function is used to detect ND protocol packet, it sets IPv6 address binding obtained by nodes with the stateless address configuration. DHCPv6 Snooping function is used to detect DHCPv6 protocol packet, it sets IPv6 address binding obtained by nodes with the stateful address configuration. RA Snooping function is used to avoid the lawless node sending the spurious RA packet.

13.10.2 SAVI Configuration

SAVI configuration task list:

1. Enable or disable SAVI function
2. Enable or disable application scene function for SAVI
3. Configure SAVI binding function
4. Configure the global max-dad-delay for SAVI
5. Configure the global max-dad-prepare-delay for SAVI
6. Configure the global max-slaac-life for SAVI
7. Configure the lifetime period for SAVI bind-protect
8. Enable or disable SAVI prefix check function
9. Configure IPv6 address prefix for a link
10. Configure the filter entry number of IPv6 address
11. Configure the check mode for SAVI conflict binding
12. Enable or disable user authentication
13. Enable or disable DHCPv6 trust of port
14. Enable or disable ND trust of port
15. Configure the binding number

1. Enable or disable SAVI function

Command	Explanation
Global mode	

savi enable	Enable the global SAVI function, no command disables the function.
no savi enable	

2. Enable or disable application scene function for SAVI

Command	Explanation
Global mode	
savi ipv6 {dhcp-only slaac-only dhcp-slaac} enable no savi ipv6 {dhcp-only slaac-only dhcp-slaac} enable	Enable the application scene function for SAVI, no command disables the function.

3. Configure SAVI binding function

Command	Explanation
Global mode	
savi ipv6 check source binding ip <ip-address> mac <mac-address> interface <if-name> {type [slaac dhcp] lifetime <lifetime> type static} no savi ipv6 check source binding ip <ip-address> interface <if-name>	Configure a static or dynamic binding manually, no command deletes the configured binding. This command may be configured in a global function of savi enable, slaac-only enable, dhcp-only enable or dhcp-slaac enable.

4. Configure the global max-dad-delay for SAVI

Command	Explanation
Global mode	
savi max-dad-delay <max-dad-delay> no savi max-dad-delay	Configure the max lifetime period of SAVI binding at DETECTION state, no command restores the default value.

5. Configure the global max-dad-prepare-delay for SAVI

Command	Explanation
Global mode	
savi max-dad-prepare-delay <max-dad-prepare-delay> no savi max-dad-prepare-delay	Configure the max redetection lifetime period for SAVI binding, no command restores the default value.

6. Configure the global max-slaac-life for SAVI

Command	Explanation
Global mode	
savi max-slaac-life <max-slaac-life> no savi max-slaac-life	Configure the lifetime period of the dynamic slaac binding at BOUND state, no command restores the default value.

7. Configure the lifetime period for SAVI bind-protect

Command	Explanation
Global mode	
savi timeout bind-protect <protect-time> no savi timeout bind-protect	Configure the bind-protect lifetime period to a port after its state from up to down, no command restores the default value.

8. Enable or disable SAVI prefix check function

Command	Explanation
Global mode	
ipv6 cps prefix check enable no ipv6 cps prefix check enable	Enable the address prefix check for SAVI, no command disables the function.

9. Configure IPv6 address prefix for a link

Command	Explanation
Global mode	
ipv6 cps prefix <ip-address> vlan <vid> no ipv6 cps prefix <ip-address>	Configure IPv6 address prefix for a link manually, no command deletes the configured address prefix.

10. Configure the filter entry number of IPv6 address

Command	Explanation
Global mode	
savi ipv6 mac-binding-limit <limit-num> no savi ipv6 mac-binding-limit	Configure the corresponding dynamic binding number for the same MAC address, no command restores the default value. Note: The binding number only limits the dynamic binding, but does not limit the static binding number.

11. Configure the check mode for SAVI conflict binding

Command	Explanation
Global mode	
savi check binding <simple probe> mode no savi check binding mode	Configure the check mode for the conflict binding, no command deletes the check mode.

12. Enable or disable user authentication

Command	Explanation
Port mode	
savi ipv6 check source [ip-address mac-address ip-address mac-address] no savi ipv6 check source	Enable the control authentication function for user, no command disables the function.

13. Enable or disable DHCPv6 trust of port

Command	Explanation
Port mode	
ipv6 dhcp snooping trust no ipv6 dhcp snooping trust	Enable DHCPv6 trust port, no command disables the trust function. (port is translated from trust port into untrust port)

14. Enable or disable ND trust of port

Command	Explanation
Port mode	
ipv6 nd snooping trust no ipv6 nd snooping trust	Configure a port as slaac trust and RA trust, no command deletes the port's trust function.

15. Configure the binding number

Command	Explanation
Port mode	
savi ipv6 binding num <limit-num> no savi ipv6 binding num	Configure the binding number of a port, no command restores the default value. Note: The binding number only limits the dynamic binding, but does not limit the static binding number.

13.10.3 SAVI Typical Application

In actual application, SAVI function is usually applied in access layer switch to check the validity of node source address on direct-link. There are four typical application scenes for SAVI function: DHCP-Only, Slaac-Only, DHCP-Slaac and Static binding. In network environment, users can select the corresponding scene according to the actual requirement; in double stacks network, while SAVI function associates with IPv4 DHCP snooping to use, IPv4 and IPv6 source address authentication is implemented.

Typical network topology application for SAVI function:

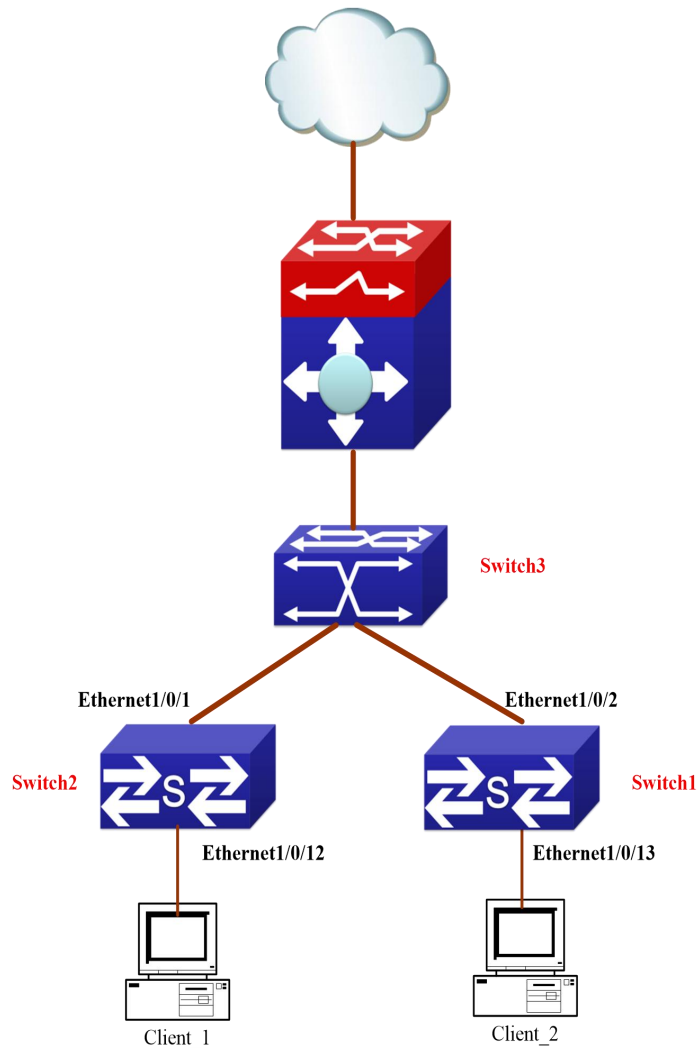

Figure 14-17

Client_1 and Client_2 means two different user's PC installed IPv6 protocol, respectively connect with port Ethernet1/0/12 of Switch1 and port Ethernet1/0/13 of Switch2, and enable the source address check function of SAVI. Ethernet1/0/1 and Ethernet1/0/2 are uplink ports of Switch1 and Switch2 respectively, enable DHCP trust and ND trust functions. Aggregation Switch3 enables DHCPv6 server function and route advertisement function.

Configuration steps of SAVI DHCP-SLAAC scene:

```
Switch1>enable
```

```
Switch1#config
```

```
Switch1(config)#savi enable
```

```
Switch1(config)#savi ipv6 dhcp-slaac enable
```

```
Switch1(config)#savi check binding probe mode
```

```
Switch1(config)#interface ethernet1/0/1
```

```
Switch1(config-if-ethernet1/0/1)#ipv6 dhcp snooping trust
```

```
Switch1(config-if-ethernet1/0/1)#ipv6 nd snooping trust
```

```
Switch1(config-if-ethernet1/0/1)#exit
```

```
Switch1(config)#interface ethernet1/0/12-20
```

```
Switch1(config-if-port-range)#savi ipv6 check source ip-address mac-address
Switch1(config-if-port-range)#savi ipv6 binding num 4
Switch1(config-if-port-range)#exit
Switch1(config)#exit
Switch1#write
```

13.10.4 SAVI Troubleshooting

After ensure no problem about SAVI client hardware and cable, please check the status which may exist and the propositional solutions in the following:

- ☞ If IPv6 packets are filtered incorrectly after enable SAVI function, please ensure the global SAVI function enabled. After that, enable the global function of the corresponding SAVI scene according to the actual application scene and enable the port authentication function.
- ☞ If client can not correctly obtain IPv6 address assigned by DHCPv6 server after enable SAVI function, please ensure DHCP port trust is configured by uplink port with DHCPv6 server.
- ☞ If node binding can not be set for the new user after enable SAVI function, please check whether the direct-link port configures the max binding number, and whether the binding number reaches to the max number. If the binding number exceeds the max binding limit, it is recommended to configure the bigger binding limit.
- ☞ If node binding can not be set for new user after configure the bigger binding limit, please check whether the direct-link port configures the corresponding binding number, and whether the corresponding binding number reaches to the max number in the same MAC address. If the binding number exceeds the max binding limit, it is recommended to configure the bigger binding limit.

13.11 IPv6 VRRPv3

13.11.1 Introduction to VRRPv3

VRRPv3 is a virtual router redundancy protocol for IPv6. It is designed based on VRRP (VRRPv2) in IPv4 environment. The following is a brief introduction to it.

In a network based on TCP/IP protocol, in order to guarantee the communication between the devices which are not physically connected, routers should be specified. At present there are two most commonly used methods to specify routers: one is to study dynamically via routing protocols (such as internal routing protocols RIP and OSPF); the other is to configure statically. Running dynamical routing protocol on each terminal is unrealistic, since most operating systems for client end do not support dynamical routing protocol, even if they do, they are limited by the overheads of management, convergence, security and many other problems. So the common method is to adopt static routing configuration on terminal IP devices, which usually means specify one or more default gateway for terminal devices. Static routing simplifies the management of network and reduces the communication overheads of terminal devices, but it still has a disadvantage: if

the router acting as the default gateway breaks, the communication of all the hosts which use this gateway as their next hop host. Even if there are more than one default gateways, before rebooting the terminal devices, they can not switch to the new gateway. Adopting virtual router redundancy protocol (VRPR) can effectively avoid the flaws of statically specifying gateways.

In VRRP protocol, there are two groups of import concepts: VRRP routers and virtual routers, master routers and backup routers. VRRP routers are routers running VRRP, which are physical entities; virtual routers are the ones created by VRRP, which are logical concepts. A group of VRRP routers cooperate to comprise a virtual router, which acts outwardly as a logical router with a unique fixed IP address and MAC address. The routers belonging to the same VRRP group play two mutually exclusive roles at the same time: master routers and backup routers. One VRRP group can only have one master router other but one or more backup routers. VRRPv3 protocol uses selection policy to select a master router from the router group to take charge of responding ND(Neighbor Discovery) neighbor request messages(ARP in IPv4) and forwarding IP data packets, while the other routers in the group will be in a state of waiting as backups. When the master router has a problem for some season, the backup router will be updated to the master router after a delay of a few seconds. Since this switch is very fast and does not need to change IP address or MAC address, it will be transparent to terminal user systems.

In IPv6 environment, the hosts in a LAN usually learn the default gateway via neighbor discovery protocol (NDP), which is implemented based on regularly receiving advertisement messages from routers. The NDP of IPv6 has a mechanism called Neighbor Unreachability Detection, which checks whether a neighbor node is failed by sending unicast neighbor request messages to it. In order to reduce the overheads of sending neighbor request messages, these messages are only sent to those neighbor nodes which are sending flows, and are only sent if there is no instruction of UP state of the router in a period of time. In Neighbor Unreachability Detection, if adopting default parameters, it will take about 38 seconds to detect an unreachable router, which is a delay not ignorable for users and might cause a time-out in some transport protocols. Compared with NDP, VRRP provides a fast default gateway switch. In VRRP, backup routers can take up the unavailable master router in about 3 seconds (default parameter), and this process needs no interaction with hosts, which means being transparent to hosts.

13.11.1.1 The Format of VRRPv3 Message

VRRPv3 has its own message format, VRRP messages are used to communicate the priority of routers and the state of Master in the backup group, they are encapsulated in IPv6 messages to send, and are sent to the specified IPv6 multicast address. The format of VRRPv3 message is shown in Graph 1. The source address of the IPv6 message encapsulating the VRRPv3 message is the local address of the outbound interface of the message, and the destination address of it is the IPv6 multicast address(the multicast allocated to VRRPv3 is FF02:0:0:0:0:0:12). The number of hops should be limited to 255, and the next message head is 112(representing a VRRP message).

The meaning of each field in a VRRPv3 message is shown as follows:

Version: The version of VRRPv3, whose value is 3;

Type: The type of VRRP messages. There is only one type: ADVERTISEMENT, and its value is 1;

Virtual Rtr ID: The ID of the virtual router;

Priority: Priority, ranging from 0 to 255;

Count IPv6 Addr: The number of IPv6 addresses in a VRRPv3 message, the minimum of which is 1;

Rsvd: Reserved field, whose value is 0;

Adver Int: The advertisement interval of VRRPv3 messages, in seconds;

Checksum: The checksum, taking account of the whole VRRPv3 message and an IPv6 pseudo head (please refer to RFC2460 for details);

IPv6 Address(es): one or more IPv6 addresses related to the virtual router, the number of which is the same with "Count IPv6 Addr", and the first one of which should be the virtual IPv6 address of the virtual router.

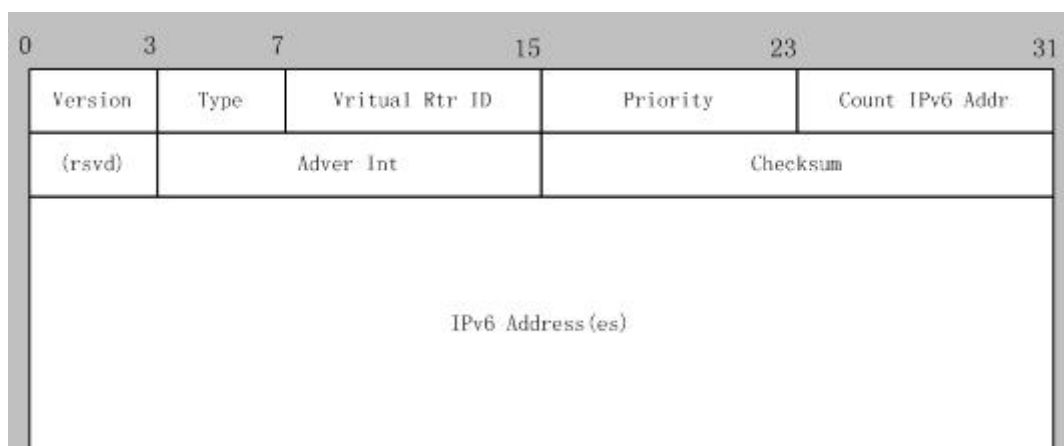

Figure 14- 18 VRRPv3 message

13.11.1.2 VRRPv3 Working Mechanism

The working mechanism of VRRPv3 is the same with that of VRRPv2, which is mainly implemented via the interaction of VRRP advertisement messages. It will be briefly described as follows:

Each VRRP router has a unique ID: VRIP, ranging from 1 to 255. This router has a unique virtual MAC address outwardly, and the format of which is 00-00-5E-00-02-{\VRID} (the format of virtual MAC address in VRRPv2 is 00-00-5E-00-01-{\VRID}). Master router is in charge of using this MAC address to respond to ND neighbor request (it is ARP request in VRRPv2). Thus, no matter what switch is made, the terminal devices will get the same IP and MAC address all the time, reducing the affection that the switch causes on terminal devices.

There is only one kind of VRRP control message: VRRP advertisement. It uses IP multicast data packets to encapsulate, and the format of multicast addresses is FF02:0:0:0:0:0:XXXX:XXXX. In order to keep a consistence with the multicast address in VRRPv2 (224.0.0.18), the multicast addresses used by VRRPv3 advertisement messages can be FF02:0:0:0:0:0:0:12, and the advertisement is limited within the same LAN. Thus, different VRID are guaranteed to be used repeatedly in different networks. In order to reduce the overheads of network bandwidth, only master routers can send VRRP advertisement messages regularly. Backup routers will start a new round of VRRP selection if it hasn't received a VRRP advertisement in 3 advertisement intervals in a row or if it receives an advertisement with a priority of 0.

In a VRRP router group, the master router is selected according to priority. The range of priority in VRRP protocol is 0-255. If the IP address of a VRRP router is the same to that of the virtual router interface, then the virtual router will be called the IP address owner in the VRRP group; the IP address owner automatically has the highest priority: 255. The priority of 0 is usually used when the IP address owner gives up the role of master. The range of priority can be configured is 1-254. The configuration rule of priority can be set according to the speed and cost of the link, the performance and reliability of the router and other management policies. In the selection of the master router, the virtual router with high priority will win. So, if there is an IP owner in the VRRP group, it will always be the master router. For the candidate routers having the same priority, selection will be done according to the magnitude of IP addresses (the bigger IP address takes precedence). VRRP also provides a preemptive priority policy. If such policy is configured, the backup router with higher priority will preempt the role of new master router over the current master router with lower priority.

In order to avoid the fault of returning a physical MAC address when Pinging virtual IP, it is regulated that virtual IP can not be the real IP of the interface. Thus, all the interfaces participating of the backup group selection will be backup by default.

13.11.2 VRRPv3 Configuration

13.11.2.1 Configuration Task Sequence

1. Create/delete the virtual router (necessary)
2. Configure the virtual IPv6 address and interface of VRRPv3 (necessary)
3. Enable/disable the virtual router (necessary)
4. Configure VRRPv3 assistant parameters (optional)
 - (1) Configure VRRPv3 preempt mode
 - (2) Configure VRRPv3 priority
 - (3) Configure the VRRPv3 advertisement interval
 - (4) Configure the monitor interface of VRRPv3

1. Create/delete the virtual router

Command	Explanation
Global Configuration Mode	
router ipv6 vrrp <vrid> no router ipv6 vrrp <vrid>	Create/delete the virtual router.

2. Configure the virtual IPv6 address and interface of VRRPv3

Command	Explanation
VRRPv3 Protocol Mode	
virtual-ipv6 <ipv6-address> Interface {Vlan <ID> IFNAME } no virtual-ipv6 interface	Configure the virtual IPv6 address and interface of VRRPv3, the no operation of this command will delete the virtual IPv6 address

	and interface.
--	----------------

3. Enable/disable the virtual router

Command	Explanation
VRRPv3 Protocol Mode	
enable	Enable the virtual router.
disable	Disable the virtual router.

4. Configure VRRPv3 assistant parameters

(1) Configure VRRPv3 preempt mode

Command	Explanation
VRRPv3 Protocol Mode	
preempt-mode {true false}	Configure VRRPv3 preempt mode.

(2) Configure VRRPv3 priority

Command	Explanation
VRRPv3 Protocol Mode	
priority <priority >	Configure VRRPv3 priority.

(3) Configure the VRRPv3 advertisement interval

Command	Explanation
VRRPv3 Protocol Mode	
advertisement-interval <time>	Configure the VRRPv3 advertisement interval (in cent seconds).

(4) Configure the monitor interface of VRRPv3

Command	Explanation
VRRPv3 Protocol Mode	
circuit-failover {vlan <ID> IFNAME} <value_reduced>	Configure the monitor interface of VRRPv3, the no operation of this command will delete the monitor interface.
no circuit-failover	

13.11.3 VRRPv3 Typical Examples

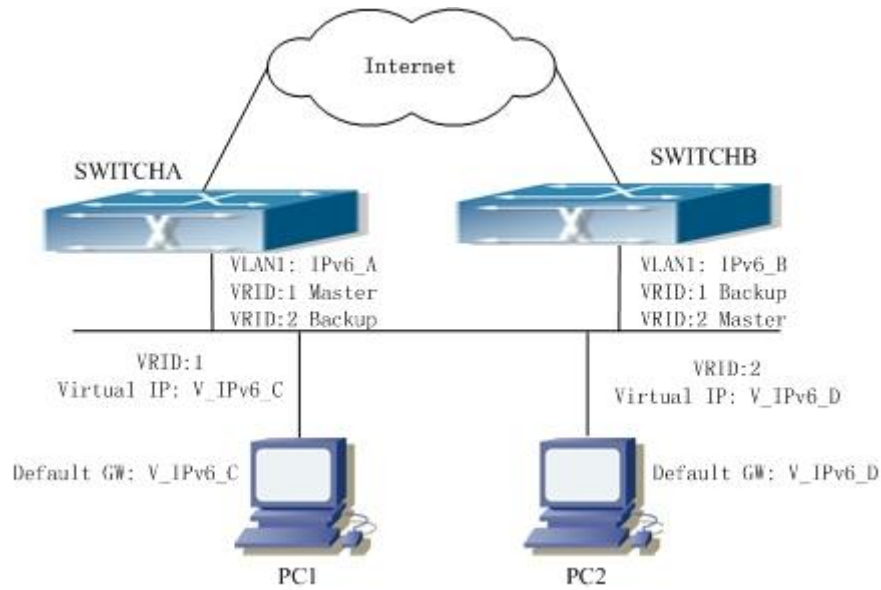

Figure 14- 19 VRRPv3 Typical Network Topology

As shown in graph, switch A and switch B are backups to each other, switch A is the master of backup group 1 and a backup of backup group 2. Switch B is the master of backup group 2 and a Backup of backup group 1. The IPv6 addresses of switch A and switch B are “IPv6_A” and “IPv6_B” respectively (it is recommended that IPv6_A and IPv6_B are in the same segment), the virtual IPv6 address of backup group 1 and backup group are “V_IPv6_C” and “V_IPv6_D” respectively, and the default IPv6 gateway address are configured as “V_IPv6_C” and “V_IPv6_D” respectively (in reality, the IPv6 gateway address of hosts are usually learnt automatically via router advertisements, thus, the IPv6 next hop of the hosts will have some randomness). Doing this will not only implement router backup but also the flow sharing function in the LAN.

The configuration of SwitchA:

```
SwitchA (config)#interface vlan 1
SwitchA (config)#router ipv6 vrrp 1
SwitchA (config-router)#virtual-ipv6 fe80::2 interface vlan 1
SwitchA (config-router)#priority 150
SwitchA (config-router)#enable
SwitchA (config)#router ipv6 vrrp 2
SwitchA (config-router)#virtual-ipv6 fe80::3 interface vlan 1
SwitchA (config-router)#enable
```

The configuration of SwitchB:

```
SwitchB (config)# interface vlan 1
SwitchB (config)# router ipv6 vrrp 2
SwitchB (config-router)# virtual-ipv6 fe80::3 interface vlan 1
SwitchB (config-router)# priority 150
SwitchB (config-router)# enable
SwitchB (config)# router ipv6 vrrp 1
SwitchB (config-router)# virtual-ipv6 fe80::2 interface vlan 1
```

SwitchB (config-router)# enable

13.11.4 VRRPv3 Troubleshooting

When configuring and using VRRPv3 protocol, it might operate abnormally because of incorrect physical connections and configuration. So, users should pay attention to the following points:

- 👉 First, the physical connections should be correct;
- 👉 Next, the interface and link protocol are UP (use **show ipv6 interface** command);
- 👉 And then, make sure that IPv6 forwarding function is enabled (use **ipv6 enable** command);
- 👉 Besides, make sure that VRRPv3 protocol is enable on the interface;
- 👉 Check whether the time of timer in different routers (or layer-three Ethernet switch) within the same backup group is the same;
- 👉 Check whether the virtual IPv6 addresses in the same backup group is the same.