





## Call conference



1. Press the Conference soft key  during an active call. The call is put on hold.
2. Call the second party's number.
3. After 2nd call is established, press the Conference soft key  to let all parties joined in the conference.

## Call transfer



### Attended transfer:

1. Press  Xfer icon during the active conversation, the call is put on hold.
2. Dial the second telephone number.
3. When the call is answered, then press  Xfer icon to complete the operation.



### Blind transfer:

1. Press  Xfer icon during the active conversation, the call will be on hold.
2. Then enter the 2nd telephone number and press  Xfer icon.

## Call forward

1. Press Phone Settings icon  > Line > Select the line > Forward Settings
2. Enter the destination number and the type of forward and press OK icon .

## Call Mute



1. Press  icon to Mute the microphone during the call.
2. Press  icon again to un-mute the conversation.

## Call list



1. Press Call Logs icon .
2. Slide the screen.
3. To dial an entry, press Dial icon.

## Phonebook

### Access phonebook:

1. Press Contact icon .
2. Select All Contacts or other group.
3. To dial an entry, press Dial icon .

### Add new entry:

1. Press Contact icon , Press All Contacts or other group > Press Add icon.
2. Enter name and number and press OK icon .

## Programmable keys



### DSS virtual keys :

1. You can use the phone web interface to configure the keys of the screen.
2. Press unfold > you can press any keys which is still blank or long press the key that have configured, select a type and value, press  icon.

## Redial

1. Press redial DSS key , redial a call number.

## Do Not Disturb

1. Press DND icon  when standby or click Phone Settings icon  > DND.
2. Select the Mode.

## Voice mail

1. To access to your voice mail, press Voice Message icon  ; it will be unread VM quantities indicated on the icon if there were new messages.
2. Select the line and press phone icon to call.

## Bluetooth

1. Press Bluetooth icon in the status bar to open Bluetooth.
2. Press Settings icon  > Connected devices > Pair new device . After opening, it displays the scanned Bluetooth list, select any device, and click on the device pairing.

## Wi-Fi

1. Enter the Settings icon  > Network & internet > Wi-Fi, enable Wi-Fi, and you can browse the list of available Wi-Fi;
2. Select the available network, click on the network to enter the password to connect and click connect button.

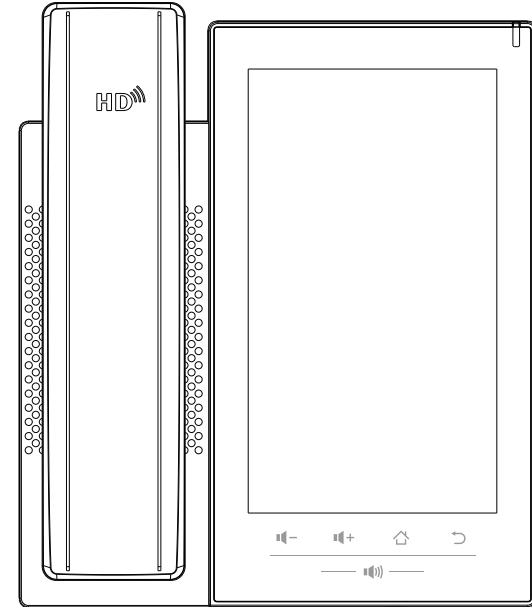

# IP Phone Quick Installation Guide

## Packaging list

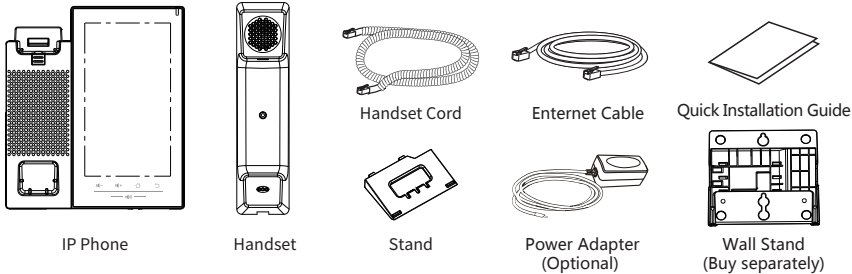

## Screen icon

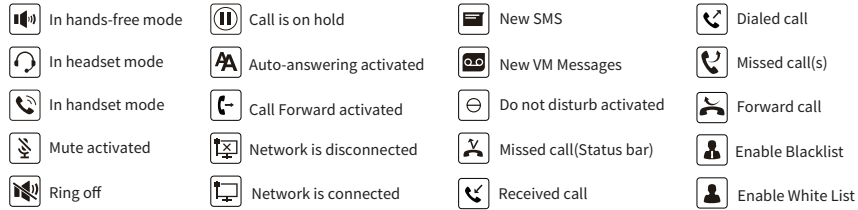

## Keys features



Home Key, Return to standby home page



Return key, Return to the previous menu/page



In idle mode or during ringing: decrease or increase ring volume  
In communication: decrease or increase handset, headset or hands-free volume



Hands-free key, Activate/deactivate hands free

## Installation the device

Please follow the instructions in below picture to install the device.

### • Bracket desktop installation

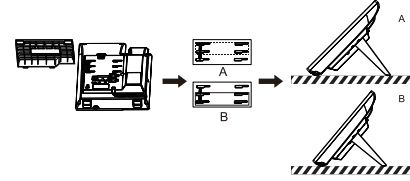

### • Wall mounting (Wall Stand need buy separately)

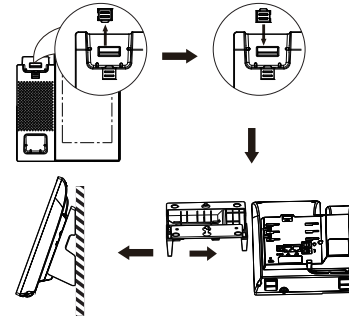

### • Connecting to the Device

Please connect power adapter, network, PC, handset, and headset to the corresponding ports as described in below picture.

- ① USB port: connect USB device (USB disk)
- ② Power port: connect the power adapter.
- ③ Network port: Connect LAN or Internet.
- ④ PC port: connect PC.
- ⑤ Headset port: connect headset.
- ⑥ Handset port: connect IP Phone handset.

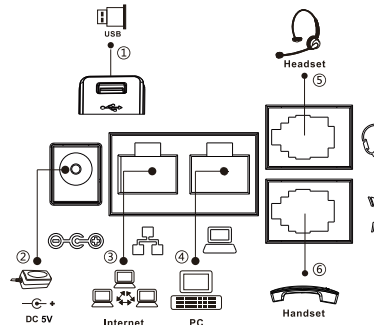

## Configuration

### Configuration via Phone

1. Press Phone Settings icon .
2. Select Ethernet Settings: To configure the Network Settings (DHCP/Static).
3. Select Line: To configure enable the account, fill the SIP server address, port, user name, password etc.

### Configuration via Web

1. Get the IP address from the phone: Press Phone Settings icon > Common.
2. Login: Input the IP address in the web browser. The PC and phone should be in the same IP address segment (The default username and password are both 'admin').
3. Configure: Select network/Account, etc. And fill the relevant content.
4. Save the configuration.

## Language setting

1. Press Settings icon > System > Language & Input > Language.
2. Select the desired language.

## Making a call

1. **Direct dialing:** lift the handset and enter the phone number.
2. **Hands-free:** press speaker key and dial phone number.
3. **Headset:** press the Headset DSS key and dial phone number.
4. **Dial icon:** Click dial icon and then enter the phone number.
5. **Designated line:** press line key first; enter phone number and then press dial key.

## Accepting a call

1. **Using the handset:** pick up the handset.
2. **Using the headset:** press Headset DSS key
3. **Using the hands-free:** press .

## Putting a call on hold

1. Press the Hold soft key during an active call.
  2. To resume the call, press the Resume soft key.
- Note: with more than one active call, select desired call by sliding screen and use the corresponding soft key to hold or resume.