



Preface

This describes the objectives, audience, organization and conventions of this guide, and describes related documents.

These topics are discussed:

- [Objectives, page 1](#)
- [Audience, page 1](#)
- [Organization, page 1](#)
- [Conventions, page 2](#)
- [Searching for Cisco Documents, page 3](#)
- [Obtaining Documentation and Submitting a Service Request, page 3](#)

Objectives

This guide provides an overview and explains how to install, connect, and perform initial configuration for the Cisco 2010 Connected Grid Routers.

For warranty, service, and support information, see the “Cisco Warranty Terms” section in the *Readme First* for the Cisco CGR 2010 document that was shipped with your router.

Audience

This documentation is designed for the person installing, configuring, and maintaining the router, who should be familiar with electronic circuitry and wiring practices and has experience as an electronic or electromechanical technician. It identifies certain procedures that should be performed only by trained and qualified personnel.

Organization

This guide includes the following sections:

Chapter	Title	Description
1	Overview of the Router, page 5	Describes the chassis views, information for locating the serial number, PID ¹ , and UDI ² , general hardware features, slot, port, and interface information, and LED indicators,
2	Preparing for Router Installation, page 15	Describes site requirements and equipment needed to install the routers.
3	Installing and Connecting the Router, page 25	Provides information about mounting the router in a rack and connecting the cables needed to install your Cisco CGR 2010 router, including how to connect AC and DC power to the router.

Chapter	Title	Description
4	Configuring the Router, page 55	Describes how to configure your Cisco CGR 2010.
5	Installing and Upgrading Internal Modules, page 77	Describes how to connect your Cisco CGR 2010 to SFP modules, single-wide and double-wide GRWICS, and to networks and external devices.
¹ PID = product ID. ² UID = universal device identifier.		

Conventions

This document uses the following conventions: This document uses the following conventions.

Conventions	Indication
bold font	Commands and keywords and user-entered text appear in bold font .
<i>italic font</i>	Document titles, new or emphasized terms, and arguments for which you supply values are in <i>italic font</i> .
[]	Elements in square brackets are optional.
{x y z }	Required alternative keywords are grouped in braces and separated by vertical bars.
[x y z]	Optional alternative keywords are grouped in brackets and separated by vertical bars.
string	A nonquoted set of characters. Do not use quotation marks around the string or the string will include the quotation marks.
<code>courier font</code>	Terminal sessions and information the system displays appear in courier font.
< >	Nonprinting characters such as passwords are in angle brackets.
[]	Default responses to system prompts are in square brackets.
!, #	An exclamation point (!) or a pound sign (#) at the beginning of a line of code indicates a comment line.

Note: Means *reader take note*. Notes contain helpful suggestions or references to material not covered in the manual.

Caution: Means *reader be careful*. In this situation, you might perform an action that could result in equipment damage or loss of data.

Warning: IMPORTANT SAFETY INSTRUCTIONS

Means danger. You are in a situation that could cause bodily injury. Before you work on any equipment, be aware of the hazards involved with electrical circuitry and be familiar with standard practices for preventing accidents. Use the statement number provided at the end of each warning to locate its translation in the translated safety warnings that accompanied this device.

SAVE THESE INSTRUCTIONS

Regulatory: Provided for additional information and to comply with regulatory and customer requirements.

Access the Regulatory Compliance and Safety Information for Cisco 2010 Connected Grid Router at:

<http://www.cisco.com/en/US/docs/routers/access/2000/CGR2010/hardware/rcsi/rcsiCGR2000series.html>

Warning: Do not use this product near water; for example, near a bath tub, wash bowl, kitchen sink or laundry tub, in a wet basement, or near a swimming pool. Statement 1035

Warning: Never touch uninsulated telephone wires or terminals unless the telephone line has been disconnected at the network interface. Statement 1037

Warning: Avoid using a telephone (other than a cordless type) during an electrical storm. There may be a remote risk of electric shock from lightning. Statement 1038

Searching for Cisco Documents

To search a HTML document using a web browser, press **Ctrl-F** (Windows) or **Cmd-F** (Apple). In most browsers, the option to search whole words only, invoke case sensitivity, or search forward and backward is also available.

To search a PDF document in Adobe Reader, use the basic Find toolbar (**Ctrl-F**) or the Full Reader Search window (**Shift-Ctrl-F**). Use the Find toolbar to find words or phrases within a specific document. Use the Full Reader Search window to search multiple PDF files simultaneously and to change case sensitivity and other options. Adobe Reader online help has more information about how to search PDF documents.

Obtaining Documentation and Submitting a Service Request

For information on obtaining documentation, using the Cisco Bug Search Tool (BST), submitting a service request, and gathering additional information, see *What's New in Cisco Product Documentation* at: <http://www.cisco.com/c/en/us/td/docs/general/whatsnew/whatsnew.html>.

Subscribe to *What's New in Cisco Product Documentation*, which lists all new and revised Cisco technical documentation as an RSS feed and delivers content directly to your desktop using a reader application. The RSS feeds are a free service.



Overview of the Router

The Cisco 2010 Connected Grid Router is the first router in the Cisco 2000 Series Connected Grid solutions. The CGR 2010 router is a ruggedized power utility substation router, which offers data functionality through Gigabit Ethernet ports, and security functionality with a VPN accelerator.

Ruggedized routers comply with specifications IEEE 1613 and IEC 61850, for products that meet stringent environmental, surge, and electromagnetic Interference (EMI) requirements for utility substation environments without moving parts or fans.

This Cisco CGR 2010 router has new rugged grid router WAN interface card (GRWIC) slots (for both single-wide and double-wide GRWICS) that support the rugged product power utility market.

These topics are discussed:

- [Chassis Views, page 5](#)
- [Hardware Features, page 6](#)
- [Slot, Port, and Interface Information, page 11](#)
- [LED Indicators, page 11](#)
- [Specifications, page 14](#)

Chassis Views

This section has views of the power supply side and cable side panels of the Cisco CGR 2010 router, showing locations of the interfaces, module slots, status indicators, and chassis identification labels.

- [Figure 1 on page 6](#) shows the Cisco 2010 Connected Grid Router chassis.
- [Figure 2 on page 6](#) shows the power supply side view of the Cisco CGR 2010 router.
- [Figure 3 on page 6](#) shows the cable side panel of the Cisco CGR 2010 router.

Figure 1 Cisco CGR 2010 Router Chassis

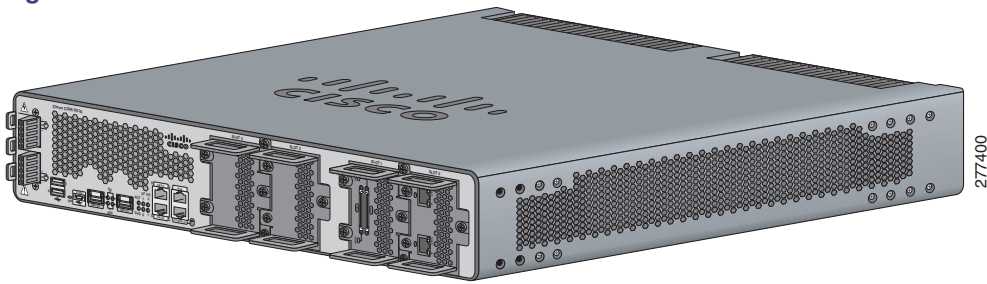

Figure 2 Power Supply Side View of the Cisco CGR 2010 Router

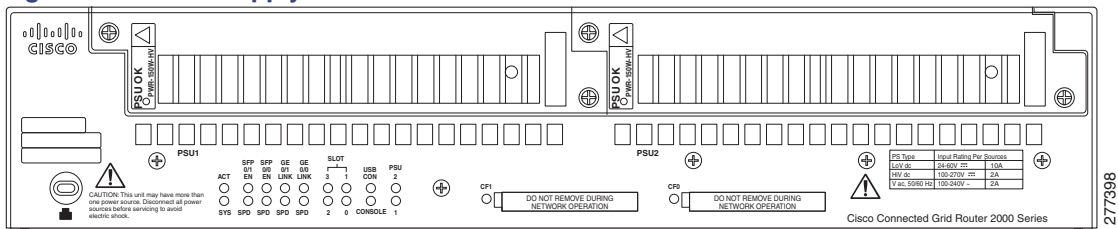
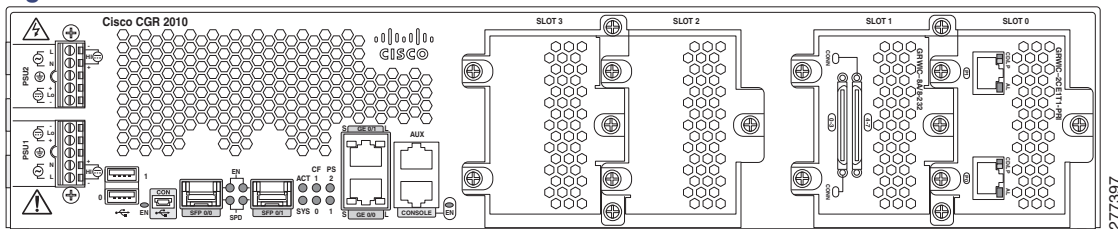

Figure 3 Cable Side View of the Cisco CGR 2010 Router



Hardware Features

This section describes the hardware features in Cisco CGR 2010 router.

- [Locating Chassis Features and Functions, page 6](#)
- [Built-in Interface Ports, page 8](#)
- [Removable and Interchangeable Modules and Cards, page 9](#)
- [Real-Time Clock, page 11](#)

Locating Chassis Features and Functions

Figure 4 on page 7 shows the different chassis features and functions available on the power supply side view of the Cisco CGR 2010 router. **Figure 5 on page 7** shows the different chassis features and functions available on the cable side view of the Cisco CGR 2010 router.

Figure 4 Power Supply Side View Features and Functions on the Cisco CGR 2010 Router

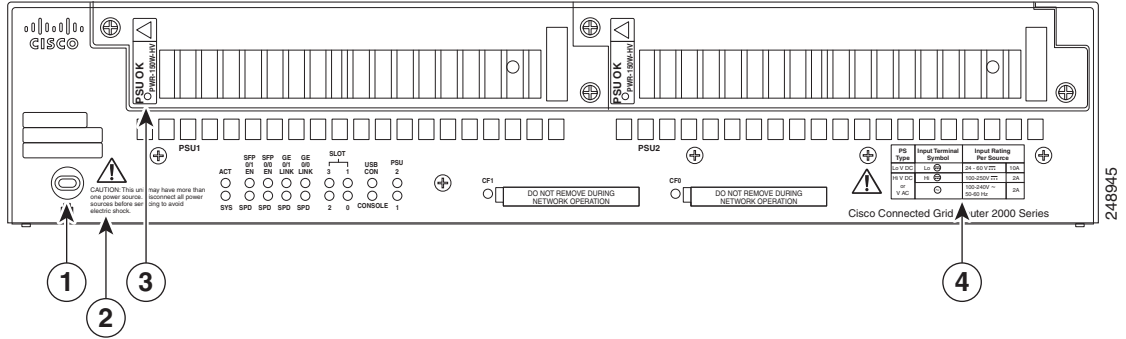

- 1 Kensington security slot
- 2 Caution label and statement for multiple power source
- 3 Power supply unit 1 (PSU1) label
- 4 Power supply power range label

Figure 5 Cable Side View Features and Functions on the Cisco CGR 2010 Router

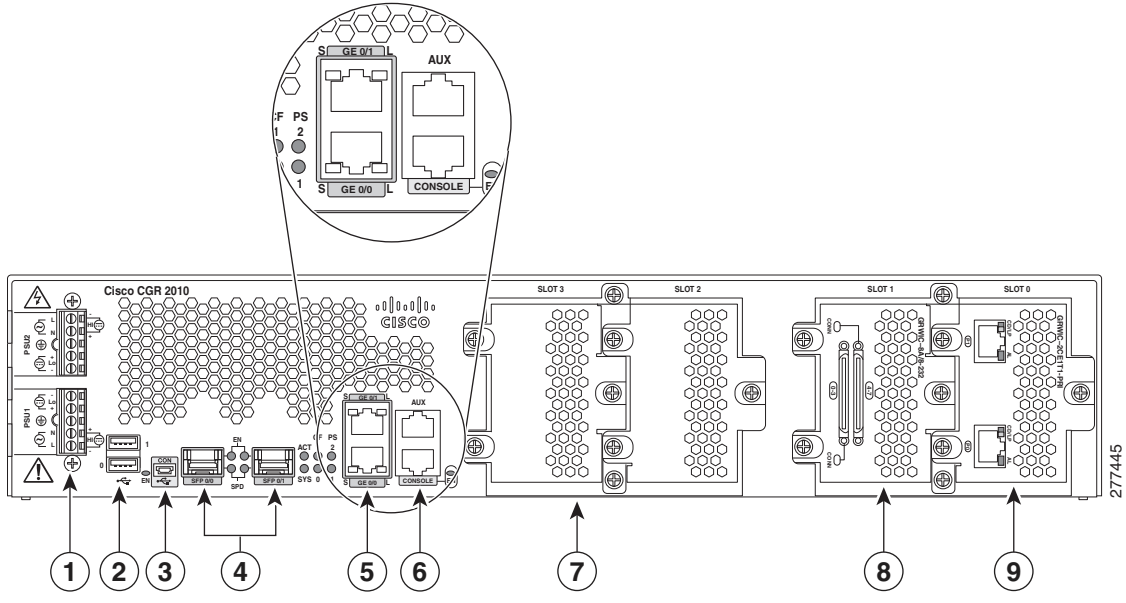

- 1 Terminal blocks¹
- 2 USB² and USB1 (1, top)
- 3 USB² serial console port
- 4 SFP0/0 and SFP0/1
- 5 100/1000 Ethernet port (GE0/0 and GE0/1)
- 6 RJ-45 aux port and serial console port
- 7 GRWIC slot 3 (slot cover showing)
- 8 GRWIC slot 2 (slot cover showing)
- 9 GRWIC slot 1 (8-port dual RS-232 serial interface showing)
- 10 GRWIC slot 0³ (T1/E1 dual port interface showing)⁴

¹ Enables AC power, high-voltage DC power, and low-voltage DC power input for dual power supplies.

² USB = Universal serial bus.

³ GRWIC slots 0, 1, 2, and 3 (slot 0 is on the far right).

⁴ For T1/E1 interfaces, shielded cables are required to meet EN55022, Cisprr 22, and EN300-386 compliance.

GRWIC Installation Options

The CGR 2010 four slots with two removable dividers allow the following GRWIC installation options:

- 4 single-wide GRWICs
- 2 single-wide GRWICs and 1 double-wide GRWIC
- 2 double-wide GRWICs

Built-in Interface Ports

[Table 1 on page 8](#) summarizes the interface ports built into the router chassis.

Table 1 Summary of Cisco CGR 2010 Built-In Interfaces

Router Model	Data Ports			Management Ports		
	10/100/1000 GE RJ-45	100/1000 SFP	USB Type A	Console, Serial, RJ-45	Console, Mini-USB (Type B)	Auxiliary, RJ-45
Cisco CGR 2010	2	2	2	1	1	1

Gigabit Ethernet Ports

There are two different types of Gigabit Ethernet ports available on Cisco CGR 2010 router.

- [Gigabit Ethernet Ports, page 8](#)
- [SFP Ports, page 8](#)

Gigabit Ethernet Ports

The Gigabit Ethernet RJ-45 copper interface ports support 100BASE-TX and 1000BASE-T.

SFP Ports

The small form factor pluggable (SFP) ports on the Cisco CGR 2010 router support the SFP modules listed in [Table 2 on page 9](#).

Table 2 Supported SFP Modules

Type of SFP Module	Model
Rugged and Industrial SFPs -40 to 140° F (-40 to 60° C)	<ul style="list-style-type: none"> ■ GLC-SX-MM-RGD ■ GLC-LX-SM-RGD ■ GLC-ZX-SM-RGD ■ GLC-FE-100LX-RGD ■ GLC-FE-100FX-RGD
Commercial SFPs 32 to 113° F (0 to 45° C)	<ul style="list-style-type: none"> ■ GLC-BX-U with digital optical monitoring (DOM) support ■ GLC-BX-D with DOM support ■ GLC-FE-100LX ■ GLC-FE-100BX-D ■ GLC-FE-100BX-U ■ GLC-FE-100FX ■ GLC-FE-100EX ■ GLC-FE-100ZX ■ CWDM-SFP with DOM support
Extended temperature SFPs 23 to 140° F (-5 to 60° C)	<ul style="list-style-type: none"> ■ SFP-GE-S with DOM support ■ SFP-GE-L with DOM support ■ SFP-GE-Z with DOM support

The SFP port shares the same physical port as an RJ-45 GE port. The SFP port can be configured for the following behaviors:

- Always use the RJ-45 port.
- Always use the SFP port.

USB Console Port

The Mini-USB type B port has been enabled to perform management tasks on the router. To use this port, you must install a Windows USB device driver before establishing physical connectivity between a personal computer and the router. See the [Installing the Cisco Microsoft Windows USB Device Driver, page 41](#) for driver installation instructions.

Removable and Interchangeable Modules and Cards

GRWICs and power supply units (PSU) for the Cisco CGR 2010 fit into external slots and can be removed or replaced without opening the chassis.

Note: See *Installing Cisco Interface Cards in Cisco Access Routers* document at: http://www.cisco.com/en/US/docs/routers/access/interfaces/ic/hardware/installation/guide/inst_ic.html for instructions that describe how to install GRWICs in the router.

Grid Router WAN Interface Cards

GRWICs are the latest generation of interface cards. GRWICs are installed in the GRWIC slots on the router (see [Figure 7 on page 83](#)).

The router can accommodate four single-wide GRWICs, or two single-wide GRWICs and one double-wide GRWIC, or two double-wide GRWICs at any one time. See [Installing Grid Router WAN Interface Cards, page 82](#).

Memory

Cisco CGR 2010 routers contain the following types of memory:

- DDR2—Stores the running configuration and routing tables, and is used for packet buffering by the network interfaces. Cisco IOS software executes from DRAM memory. Supports 1-GB on board DDR2.
- Boot/NVRAM—Stores the bootstrap program (ROM monitor), the configuration register, and the startup configuration.
- Flash memory—External flash memory. Stores the operating system software image. Supports two external 4 GB I-temp compact flash memory cards.
- Two 1-GB USB flash memory sticks (MEMUSB-1024FT), one each in drives USB 0 and USB 1.

Power Supplies

Cisco CGR 2010 supports three PSUs (power supply units). Power supplies are field replaceable, externally accessible, and hot swappable.

[Table 3 on page 10](#) summarizes the three power supply options.

Table 3 Power-Supply Modules

Model	Description
PWR-RGD-AC-DC	High-voltage AC or DC power supply.
PWR-RGD-LOW-DC	Low-voltage DC power supply.
PWR-RGD-AC-DC-C	High-voltage AC or DC power supply. China-specific model.

Note: Any combination of power supplies can be inserted into the chassis. Dual power supply configurations are load sharing in redundancy mode. A single power supply is sufficient for supporting power needs to the system.

Caution: Two types of power supplies are supported on the Cisco CGR 2010 router: a low-voltage DC power supply and a high-voltage DC/AC power supply. Take caution when selecting the correct input voltage for the power supply installed or damage will result. For details on connecting AC and DC power supplies, see the [Power-Supply Modules, page 30](#).

[Table 4 on page 11](#) summarizes the power options.

Table 4 Cisco CGR 2010 Power Options

Router	AC	AC + POE	DC	Hot Swap	Internal RPS ¹	Dual DC ²
CGR 2010	Yes	No	Yes	Yes	Yes	No
¹ Internal RPS means that additional power supply can be added to the PS2 slot.						
² Dual DC means two separate DC lines input to the same power supply.						

Real-Time Clock

Upon system power up, the internal real-time clock with battery backup provides the system software with time of day. This allows the system to verify the validity of the certification authority (CA) certificate. The Cisco CGR 2010 has a lithium battery. This battery lasts the life of the router under the operating environmental conditions specified for the router and is not field-replaceable.

Note: If the lithium battery in a Cisco CGR 2010 router should fail, the router must be returned to Cisco for repair.

Slot, Port, and Interface Information

On the Cisco CGR 2010 router, the numbering format for slots and ports is defined as follows: **interface type 0/slot/port**. "0" indicates slots that are built into the chassis of a router.

LED Indicators

[Figure 6 on page 12](#) summarizes the LED indicators that are located on the router bezel or chassis, but not on the removable interface cards.

LED Indicators

Figure 6 Power Supply Side View LEDs on the Cisco CGR 2010 Router

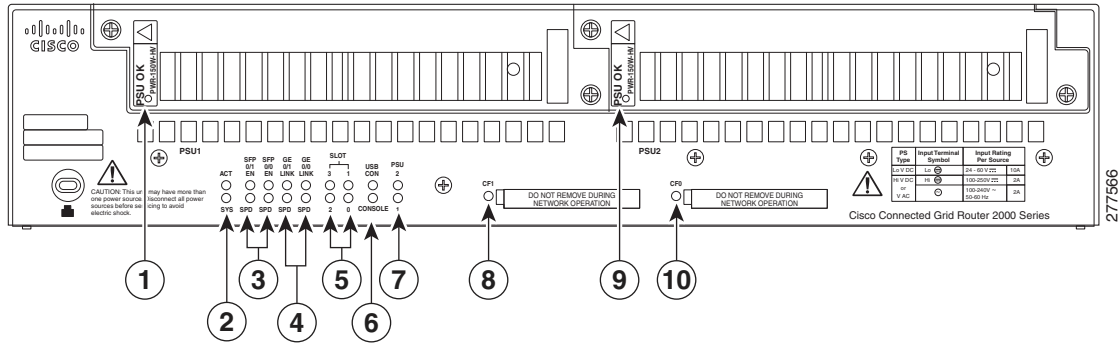

- | | |
|--|--|
| 1 PSU ¹ OK LED | 2 ACT ² and SYS ³ LEDs |
| 3 SFP ^{0/1} 4 EN ⁵ SPD ⁶ LEDs | 4 GE ^{0/1} 7 LNK ⁸ and SPD LED |
| 5 SLOT LEDs (slots 0 through 3) | 6 Console/USB connection LEDs |
| 7 PSU1/2 LEDs | 8 Compact flash slot 1 LED |
| 9 PSU OK LED | 10 Compact flash slot 0 LED |
- ¹ PSU = Power supply unit
- ² ACT = Activity
- ³ SYS = System
- ⁴ SFP = Small form-factor pluggable module slots 0 and 1
- ⁵ EN = Enable
- ⁶ SPD = Speed
- ⁷ GE = Gigabit Ethernet slots 0 and 1
- ⁸ LNK = Link

Figure 7 Cable Side View LEDs on the Cisco CGR 2010 Router

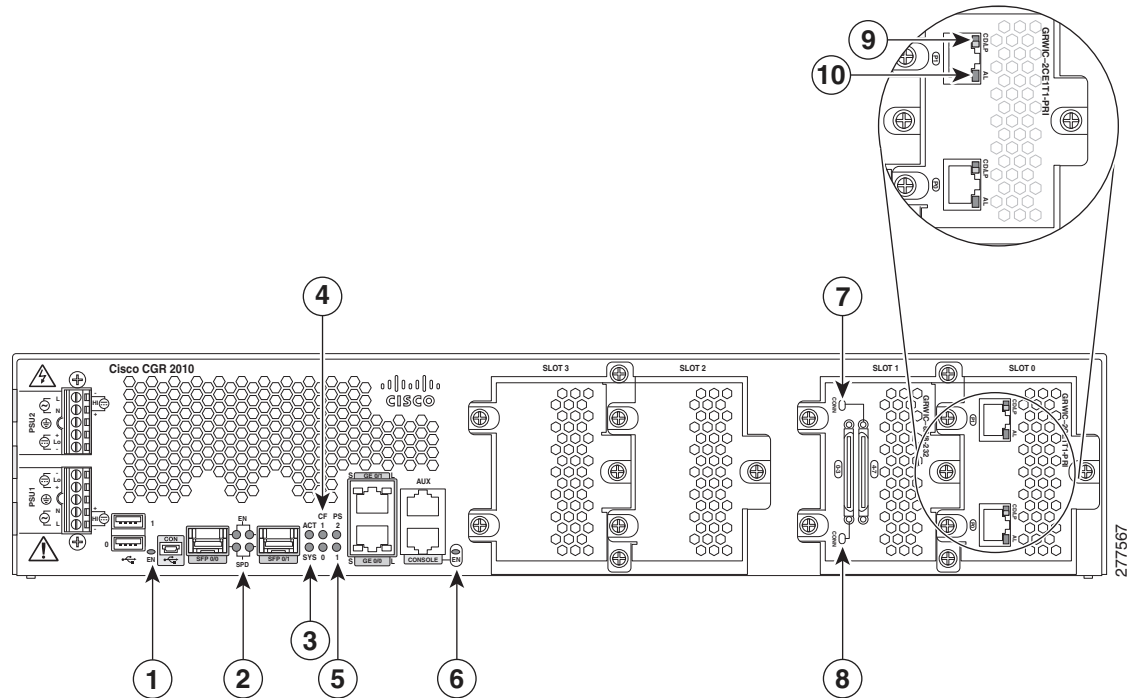

LED Indicators

- | | | | |
|---|---------------------------------|----|---|
| 1 | EN (enable USB console) | 2 | SFP EN and SPD LEDs |
| 3 | ACT status and SYS status LEDs | 4 | Compact flash 0 and 1 (0, bottom, 1, top) |
| 5 | PSU1 (bottom), PSU2 (top) | 6 | EN (enable RJ-45 console) |
| 7 | GRWIC serial interface CONN LED | 8 | GRWIC serial interface CONN LED |
| 9 | Dual-port T1/E1 GRWIC CD/LP LED | 10 | Dual-port T1/E1 GRWIC AL LED |

For LED troubleshooting information, including possible trouble causes and corrective actions, see [Table 5 on page 13](#) and [Table 6 on page 14](#).

Table 5 Cisco CGR 2010 LED Indicators – Cable Side

LED	Color	Description
SYS	Solid green	Solid green indicates normal operation.
	Blinking green	System is booting or is in ROM monitor mode.
	Amber	System error.
	Off	Power is off or system board is faulty.
ACT	Solid or blinking green	Solid or blinking indicates packet activity between the forwarding and routing engine and any I/O port.
	Off	No packet transfers are occurring.
CF 0 CF 1	Green	Flash memory is being accessed; do not eject the compact flash memory card.
	Amber	Compact flash error.
	Off	Flash memory is not being accessed; okay to eject the compact flash memory card.
PSU 1 PSU 2	Green	Valid output.
	Red	Invalid output.
	Blinking red	Invalid input
CONSOLE EN (RJ-45)	Green	Serial console is active.
USB CON	Green	USB console is active.
SFP 0/0 EN SFP 0/1 EN	Off	Not present.
	Green	Present and enabled.
	Amber	Present with failure.
SFP 0/0 SPD SFP 0/1 SPD	Off	No link.
	blinking	Blink frequency indicates port speed: <ul style="list-style-type: none"> ■ 2 blinks before pause – 100Mbps link speed. ■ 3 blinks before pause – 1000Mbps link speed.

Table 6 Cisco CGR 2010 LED Indicators – Power Supply Side

LED	Color	Description
SYS	Solid green	Solid green indicates normal operation.
	Blinking green	System is booting or is in ROM monitor mode.
	Amber	System error.
	Off	Power is off or system board is faulty.
ACT	Solid or blinking green	Solid or blinking indicates packet activity between the forwarding and routing engine and any I/O port.
	Off	No packet transfers are occurring.
PSU 1 PSU 2	Green	Valid output.
	Red	Invalid output.
	Blinking red	Invalid input
CF 0 CF 1	Green	Flash memory is being accessed; do not eject the compact flash memory card.
	Amber	Compact flash error.
	Off	Flash memory is not being accessed; okay to eject the compact flash memory card.
CONSOLE EN (RJ-45)	Green	Serial console is active.
USB CON	Green	USB console is active.
SLOT 0 SLOT 1 SLOT 2 SLOT 3	Green	GRWIC is active.
	Amber	GRWIC is not active.
SFP 0/0 EN SFP 0/1 EN	Off	Not present.
	Green	Present and enabled.
	Amber	Present with failure.
SFP 0/0 SPD SFP 0/1 SPD	Off	No link.
	blinking	Blink frequency indicates port speed: <ul style="list-style-type: none"> ■ 2 blinks before pause – 100Mbps link speed. ■ 3 blinks before pause – 1000Mbps link speed.
GE 0/0 LINK GE 0/1: LINK	Green	Solid green indicates the Ethernet port has a link partner.
GE 0/0 SPD GE 0/1 SPD	Off	No link.
	blinking	Blink frequency indicates port speed: <ul style="list-style-type: none"> ■ 2 blinks before pause – 100Mbps link speed. ■ 3 blinks before pause – 1000Mbps link speed.

Specifications

To view specifications for the Cisco CGR 2010 router, see the Cisco 2010 Connected Grid Router data sheet at:

http://www.cisco.com/en/US/prod/collateral/routers/ps10967/ps10977/data_sheet_c78_593509.html



Preparing for Router Installation

This section provides preinstallation information such as recommendations and requirements to review prior to installing your router.

The following sections prepare you for installation.

- [Safety Recommendations, page 16](#)
- [General Site Requirements, page 17](#)
- [Rack Requirements, page 17](#)
- [Router Environmental Requirements, page 17](#)
- [Power Guidelines and Requirements, page 18](#)
- [Required Tools and Equipment for Installation and Maintenance, page 22](#)
- [Installation Checklist, page 23](#)
- [Creating a Site Log, page 24](#)

Note: To see translated warnings that appear in this publication, see the [Cisco Connected Grid Routers Series Regulatory Compliance and Safety Information](#) document.

Warning: Only trained and qualified personnel should be allowed to install, replace, or service this equipment. Statement 1030

Warning: Ultimate disposal of this product should be handled according to all national laws and regulations. Statement 1040

Warning: This equipment must be installed and maintained by service personnel as defined by AS/NZS 3260. Incorrectly connecting this equipment to a general-purpose outlet could be hazardous. The telecommunications lines must be disconnected 1) before unplugging the main power connector or 2) while the housing is open, or both. Statement 1043

Warning: This unit might have more than one power supply connection. All connections must be removed to de-energize the unit. Statement 1028

Warning: This product relies on the building's installation for short-circuit (overcurrent) protection. Ensure that the protective device is rated not greater than: Maximum 15 A, 120 Vac or Maximum 10 A, 230 Vac Statement 1005

Warning: Take care when connecting units to the supply circuit so that wiring is not overloaded. Statement 1018

Warning: Hazardous network voltages are present in WAN ports regardless of whether power to the unit is OFF or ON. To avoid electric shock, use caution when working near WAN ports. When detaching cables, detach the end away from the unit first. Statement 1026

Warning: Installation of the equipment must comply with local and national electrical codes. Statement 1074

Warning: This unit is intended for installation in restricted access areas. A restricted access area can be accessed only through the use of a special tool, lock and key, or other means of security. Statement 1017

Warning: Blank faceplates and cover panels serve three important functions: they prevent exposure to hazardous voltages and currents inside the chassis; they contain electromagnetic interference (EMI) that might disrupt other equipment; and they direct the flow of cooling air through the chassis. Do not operate the system unless all cards, faceplates, front covers, and rear covers are in place.

Statement 1029

Safety Recommendations

Follow these guidelines to ensure general safety:

- Keep the chassis area clear and dust-free during and after installation.
- Keep tools and chassis components away from walk areas.
- Do not wear loose clothing that could get caught in the chassis. Fasten your tie or scarf and roll up your sleeves.
- Wear safety glasses when working under conditions that might be hazardous to your eyes.
- Do not perform any action that creates a hazard to people or makes the equipment unsafe.

Safety with Electricity

Follow these guidelines when working on equipment powered by electricity:

- Locate the emergency power-off switch in the room in which you are working. If an electrical accident occurs, you can quickly turn off the power.
- Disconnect all power before doing the following:
 - Installing or removing a chassis
 - Working near power supplies
- Look carefully for possible hazards in your work area, such as moist floors, ungrounded power extension cables, frayed power cords, and missing safety grounds.
- Do not work alone if hazardous conditions exist.
- Never assume that power is disconnected from a circuit. Always check.
- Never open the enclosure of the router's internal power supply.
- If an electrical accident occurs, proceed as follows:
 - Use caution; do not become a victim yourself.
 - Turn off power to the device.
 - If possible, send another person to get medical aid. Otherwise, assess the victim's condition and then call for help.
 - Determine if the person needs rescue breathing or external cardiac compressions; then take appropriate action.

Warning: This unit might have more than one power supply connection. All connections must be removed to de-energize the unit. **Statement 1028**

Warning: Do not work on the system or connect or disconnect cables during periods of lightning activity. **Statement 1001**

Warning: Read the installation instructions before connecting the system to the power source. **Statement 1004**

Preventing Electrostatic Discharge Damage

Electrostatic discharge (ESD) can damage equipment and impair electrical circuitry. It can occur if electronic printed circuit cards are improperly handled and can cause complete or intermittent failures. Always follow ESD prevention procedures when removing and replacing modules:

- Ensure that the router chassis is electrically connected to earth ground.
- Wear an ESD-preventive wrist strap, ensuring that it makes good skin contact. Connect the clip to an unpainted surface of the chassis frame to channel unwanted ESD voltages safely to ground. To guard against ESD damage and shocks, the wrist strap and cord must operate effectively.
- If no wrist strap is available, ground yourself by touching a metal part of the chassis.

Caution: For the safety of your equipment, periodically check the resistance value of the antistatic strap. It should be between 1 and 10 megohms (Mohm).

General Site Requirements

This section describes the requirements your site must meet for safe installation and operation of your router. Ensure that the site is properly prepared before beginning installation. If you are experiencing shutdowns or unusually high errors with your existing equipment, this section can also help you isolate the cause of failures and prevent future problems.

Rack Requirements

The following information will help you plan your equipment rack configuration:

- Allow clearance around the rack for maintenance.
- Allow at least one rack unit of vertical space between routers.
- Enclosed racks must have adequate ventilation. Ensure that the rack is not congested, because each router generates heat. An enclosed rack should have louvered sides and a fan to provide cooling air. Heat generated by equipment near the bottom of the rack can be drawn upward into the intake ports of the equipment above.

Router Environmental Requirements

Mount the Cisco CGR 2010 routers in a rack. The location of your router and the layout of your equipment rack or wiring room are extremely important considerations for proper operation. Equipment placed too close together, inadequate ventilation, and inaccessible panels can cause malfunctions and shutdowns, and can make maintenance difficult. Plan for access to both power supply side and cable side panels of the router.

Note: Allow at least one rack unit of vertical space above the router.

When planning your site layout and equipment locations, refer to [General Site Requirements, page 17](#). If you are currently experiencing shutdowns or an unusually high number of errors with your existing equipment, these precautions and recommendations may help you isolate the cause of failure and prevent future problems.

- Ensure that the room where your router operates has adequate air circulation. Electrical equipment generates heat. Without adequate air circulation, ambient air temperature may not cool equipment to acceptable operating temperatures.
- Always follow ESD-prevention procedures described in [Preventing Electrostatic Discharge Damage, page 17](#) to avoid damage to equipment. Damage from static discharge can cause immediate or intermittent equipment failure.

- Ensure that the chassis cover and module cable side panels are secure. All empty interface card slots and power supply bays must have filler panels installed.
- When equipment installed in a rack (particularly in an enclosed rack) fails, try operating the equipment by itself, if possible. Power off other equipment in the rack (and in adjacent racks) to allow the router under test a maximum of cooling air and clean power.

Power Guidelines and Requirements

Check the power at your site to ensure that you are receiving “clean” power (free of spikes and noise). Install a power conditioner if necessary.

The AC power supply includes the autoselect feature for either 110 V or 220 V operation.

Caution: Two types of power supplies are supported on the Cisco CGR 2010: a low-voltage DC power supply and a high-voltage DC/AC power supply. Take caution when selecting the correct input voltage for the power supply installed or damage will result.

Network Cabling Specifications

The following sections describe the cables needed to install your Cisco CGR 2010 router:

- [Console and Auxiliary Port Considerations, page 18](#)
- [Preparing for Network Connections, page 19](#)

Console and Auxiliary Port Considerations

The Cisco CGR 2010 router includes an asynchronous serial console port and an auxiliary port. The console and auxiliary ports provide access to the router either locally using a console terminal connected to the console port, or remotely using a modem connected to the auxiliary port. This section discusses important cabling information to consider before connecting the router to a console terminal or modem.

The main difference between the console and auxiliary ports is that the auxiliary port supports hardware flow control and the console port does not. Flow control paces the transmission of data between a sending device and a receiving device. Flow control ensures that the receiving device can absorb the data sent to it before the sending device sends more. When the buffers on the receiving device are full, a message is sent to the sending device to suspend transmission until the data in the buffers has been processed. Because the auxiliary port supports flow control, it is ideally suited for use with the high-speed transmissions of a modem. Console terminals send data at slower speeds than modems; therefore, the console port is ideally suited for use with console terminals.

Console Port Connections

The router has both EIA/TIA-232 asynchronous (RJ-45) and USB 5-pin mini Type B, 2.0 compliant serial console ports. The console ports do not have any hardware flow control. Shielded USB cables with properly terminated shields are recommended.

EIA/TIA-232 Port

Depending on the cable and the adapter used, this port appears as a DTE or DCE device at the end of the cable. Only one port can be used at the same time.

The default parameters for the console port are 9600 baud, 8 data bits, no parity, and 1 stop bit. The console port does not support hardware flow control. For detailed information about installing a console terminal, see [Connecting to a Console Terminal or Modem, page 38](#).

For cable and port pinouts, see [Cisco Modular Access Router Cable Specifications](#).

USB Serial Console Port

The USB serial console port connects directly to the USB connector of a PC using a USB Type A to 5-pin mini USB Type-B cable. The USB Console supports full speed (12Mb/s) operation. The console port does not support hardware flow control.

Note: Always use shielded USB cables with a properly terminated shield.

The default parameters for the console port are 9600 baud, 8 data bits, no parity, and 1 stop bit. The console port does not support mode control. For detailed information about installing a console terminal, see [Connecting to a Console Terminal or Modem, page 38](#).

For operation with Microsoft Windows, the Cisco Windows USB Console Driver must be installed on every PC connected to the console port. If the driver is not installed, prompts guide you through a simple installation process. For detailed information about installing the Cisco Windows USB Console Driver see [Installing the Cisco Microsoft Windows USB Device Driver, page 41](#).

The Cisco Windows USB Console Driver allows plugging and unplugging the USB cable from the console port without affecting Windows HyperTerminal operations. No special drivers are needed for Mac OS X or Linux.

Only one console port can be active at a time. When a cable is plugged into the USB console port the RJ-45 port becomes inactive. Conversely, when the USB cable is removed from the USB port, the RJ-45 port becomes active.

Baud rates for the USB console port are 1200, 2400, 4800, 9600, 19200, 38400, 57600, and 115200 bps.

Note: 4-pin mini USB Type-B connectors are easily confused with 5-pin mini USB Type-B connectors. They are not compatible. Only the 5-pin mini USB Type-B can be used.

Auxiliary Port Connections

The router has an EIA/TIA-232 asynchronous serial auxiliary port (RJ-45) that supports flow control. Depending on the cable and the adapter used, this port appears as a DTE or DCE device at the end of the cable.

Preparing for Network Connections

When setting up your router, consider distance limitations and potential electromagnetic interference (EMI) as defined by the applicable local and international regulations.

Network connection considerations are provided for several types of network interfaces and are described in the following sections:

- [Ethernet Connections, page 20](#)
- [Serial Connections, page 20](#)

See the following document for more information about network connections and interfaces:

- [Cisco Modular Access Router Cable Specifications](#)

Warning: To avoid electric shock, do not connect safety extra-low voltage (SELV) circuits to telephone-network voltage (TNV) circuits. LAN ports contain SELV circuits, and WAN ports contain TNV circuits. Some LAN and WAN ports both use RJ-45 connectors. Statement 1021

Ethernet Connections

The IEEE has established Ethernet as standard IEEE 802.3. The Cisco CGR 2010 router supports the following Ethernet implementations:

- 1000BASE-X—1000 Mb/s full-duplex transmission over a Category 5 or better unshielded twisted-pair (UTP) cable (IEEE 802.3z). Supports the Ethernet maximum length of 328 feet (100 meters).
- 1000BASE-T—1000 Mb/s full-duplex transmission over a Category 5 or better unshielded twisted-pair (UTP) cable (IEEE 802.3ab). Supports the Ethernet maximum length of 328 feet (100 meters).
- 100BASE-TX—100 Mb/s full-duplex transmission over a Category 5 or better unshielded twisted-pair (UTP) cable (IEEE 802.3u). Supports the Ethernet maximum length of 328 feet (100 meters).

See [Cisco Modular Access Router Cable Specifications](http://www.cisco.com) at www.cisco.com for information about Ethernet cables, connectors, and pinouts.

Serial Connections

Serial connections are provided by the grid router WAN interface card (GRWIC). Before you connect a device to a serial port, you need to know the following:

- Type of device, data terminal equipment (DTE) or data communications equipment (DCE), you are connecting to the synchronous serial interface
- Type of connector, male or female, required to connect to the device
- Signaling standard required by the device

Configuring Serial Connections

The serial ports on the asynchronous/synchronous serial network modules and the serial grid router WAN interface card use a GRWIC-8A/S cable with a DB-25 connector. Serial ports can be configured as DTE or DCE, depending on the serial cable used.

Serial DTE or DCE Devices

A device that communicates over a synchronous serial interface is either a DCE or DTE device. A DCE device provides a clock signal that paces the communications between the device and the router. A DTE device does not provide a clock signal. DTE devices usually connect to DCE devices. The documentation that accompanied the device should indicate whether it is a DTE or DCE device. (Some devices have a jumper to select either DTE or DCE mode.) The following table lists typical DTE and DCE devices.

Device Type	Gender	Typical Devices
DTE	Male ¹	Terminal PC
DCE	Female ²	Modem CSU/DSU Multiplexer

¹ If pins protrude from the base of the connector, the connector is male.

² If the connector has holes to accept pins, the connector is female.

Signaling Standards Supported

The synchronous serial ports available for the router support the following signaling standards: EIA/TIA-232 (EIA-323). You can order a Cisco DB-25 shielded serial transition cable that has the appropriate connector for the standard you specify. The documentation for the device should indicate the standard used for that device. The router end of the shielded serial transition cable has a DB-25 connector, which connects to the DB-25 port on a serial grid router WAN interface card. The other end of the serial transition cable is available with a connector appropriate for the standard you specify. For a list of the serial cables supported for GRWICs as well as the pinouts, see [Connectors and Cabling for the 8-Port Asynchronous/ Synchronous RS-232 GRWIC, page 51](#).

The synchronous serial port can be configured as DTE or DCE, depending on the attached cable.

All serial ports configured as DTE require external clocking from a CSU/DSU or other DCE device.

Distance Limitations

Serial signals can travel a limited distance at any given bit rate; generally, the slower the data rate, the greater the distance. All serial signals are subject to distance limits, beyond which a signal significantly degrades or is completely lost.

[Table 1 on page 21](#) lists the recommended maximum speeds and distances for each serial interface type; however, you might get good results at speeds and distances greater than those listed, if you understand the electrical problems that might arise and can compensate for them. For instance, the recommended maximum rate for V.35 is 2 Mb/s, but 4 Mb/s is commonly used.

Table 1 Serial Signal Transmission Speeds and Distances

Rate (bps)	Distance for EIA/TIA-232		Distance for X.21 and V.35		Distance for USB	
	Feet	Meters	Feet	Meters	Feet	Meters
2400	200	60	4100	1250	16.4	5
4800	100	30	2050	625	16.4	5
9600	50	15	1025	312	16.4	5
19200	25	7.6	513	156	16.4	5
38400	12	3.7	256	78	16.4	5
56000	8.6	2.6	102	31	16.4	5
1544000 (T1)	–	–	50	15	16.4	5

Asynchronous/Synchronous Serial Module Baud Rates

The following baud-rate limitations apply to the slow-speed serial interfaces found in the asynchronous/synchronous serial modules:

- Asynchronous interface—Maximum baud rate is 115.2 kbps.
- Synchronous interface—Maximum baud rate is 128 kbps full duplex.

Required Tools and Equipment for Installation and Maintenance

You need the following tools and equipment to install and upgrade the router and its components:

- ESD-preventive cord and wrist strap
- Number 2 Phillips screwdriver
- Phillips screwdrivers: small, 3/16-in. (4 to 5 mm) and medium, 1/4-in. (6 to 7 mm)
- Screws that fit your rack

In addition, depending on the type of modules you plan to use, you might need the following equipment to connect a port to an external network:

- Cables for connection to the WAN and LAN ports (dependent on configuration).

For more information on cable specifications, see [Cisco Modular Access Router Cable Specifications](http://www.cisco.com) at www.cisco.com.

- Ethernet hub or PC with a network interface card for connection to an Ethernet (LAN) port.
- Console terminal (an ASCII terminal or a PC running HyperTerminal or similar terminal emulation software) configured for 9600 baud, 8 data bits, 1 stop bit, no flow control, and no parity.
- Modem for connection to the auxiliary port for remote administrative access (optional).
- Data service unit (DSU) or channel service unit/data service unit (CSU/DSU) as appropriate for serial interfaces.
- External CSU for any CT1/PRI modules without a built-in CSU.

Installation Checklist

The sample installation checklist [on page 23](#) lists items and procedures for installing a new router. Make a copy of this checklist and mark the entries when completed. Include a copy of the checklist for each router in your site log (described in [Creating a Site Log, page 24](#)).

Installation checklist for site _____		
Router name _____		
Task	Verified by	Date
Installation checklist copied		
Background information placed in Site Log		
Site power voltages verified		
Installation site power check completed		
Required tools available		
Additional equipment available		
Router received		
Product registration card received		
www.cisco.com contact information label received		
Chassis components verified		
Initial electrical connections established		
ASCII terminal (for local configuration) or modem (for remote configuration) available		
Signal distance limits verified		
Startup sequence steps completed		
Initial operation verified		
Software image verified		

Creating a Site Log

The Site Log provides a record of all actions related to the router. Keep it in an accessible place near the chassis where anyone who performs tasks has access to it. Use the installation checklist to verify steps in the installation and maintenance of the router. Site Log entries might include the following information:

- Installation progress—Make a copy of the installation checklist and insert it into the site log. Make entries as each procedure is completed.
- Upgrade and maintenance procedures—Use the site log as a record of ongoing router maintenance and expansion history. A site log might include the following events:
 - Installation of GRWICs
 - Removal or replacement of GRWICs and other upgrades
 - Configuration changes
 - Maintenance schedules and requirements
 - Maintenance procedures performed
 - Intermittent problems
 - Comments and notes

Inspect all items for shipping damage. If anything appears to be damaged or you encounter problems installing or configuring your router, contact Cisco customer service. Warranty, service, and support information is in the quick start guide that shipped with your router.



Installing and Connecting the Router

This section describes how to install and connect Cisco CGR 2010 routers to a LAN or WAN, as well as how to connect AC or DC power to the router.

These topics are discussed.

- [What you Need to Know, page 26](#)
- [Before You Begin, page 27](#)
- [Unpacking the Router, page 27](#)
- [Installing the Router in a Rack, page 27](#)
- [Power-Supply Modules, page 30](#)
- [Connecting to a Console Terminal or Modem, page 38](#)
- [Installing the Cisco Microsoft Windows USB Device Driver, page 41](#)
- [Uninstalling the Cisco Microsoft Windows USB Driver, page 42](#)
- [Connecting to the Auxiliary Port, page 43](#)
- [Connecting WAN and LAN Interfaces, page 44](#)
- [Auxiliary Port, Console Port, and Adapter Pinouts for the Cisco CGR 2010 Router, page 45](#)
- [Connectors and Cabling for the 8-Port Asynchronous/ Synchronous RS-232 GRWIC, page 51](#)

Note: To see translations of the warnings that appear in this publication, see [Cisco Connected Grid Routers Series Regulatory Compliance and Safety Information](#).

Caution: For the optimum temperature ranges, do not operate it in an area that less than the minimum of 40° C and exceeds a maximum recommended ambient temperature of 60° C.

Note: To view specifications for the CGR 2010 router, see the Cisco 2010 Connected Grid Router data sheet at:

http://www.cisco.com/en/US/prod/collateral/routers/ps10967/ps10977/data_sheet_c78_593509.html

Warning: Only trained and qualified personnel should be allowed to install, replace, or service this equipment. Statement 1030

Warning: This unit might have more than one power supply connection. All connections must be removed to de-energize the unit. Statement 1028

Warning: Hazardous network voltages are present in WAN ports regardless of whether power to the unit is OFF or ON. To avoid electric shock, use caution when working near WAN ports. When detaching cables, detach the end away from the unit first. Statement 1026

Warning: Do not use this product near water; for example, near a bath tub, wash bowl, kitchen sink or laundry tub, in a wet basement, or near a swimming pool. Statement 1035

Warning: Avoid using a telephone (other than a cordless type) during an electrical storm. There may be a remote risk of electric shock from lightning. Statement 1038

Warning: This unit is intended for installation in restricted access areas. A restricted access area can be accessed only through the use of a special tool, lock and key, or other means of security. Statement 1017

Warning: Stability hazard. The rack stabilizing mechanism must be in place, or the rack must be bolted to the floor before you slide the unit out for servicing. Failure to stabilize the rack can cause the rack to tip over. Statement 1048

Warning: The chassis should be mounted on a rack that is permanently affixed to the building. Statement 1049

Warning: Blank faceplates and cover panels serve three important functions: they prevent exposure to hazardous voltages and currents inside the chassis; they contain electromagnetic interference (EMI) that might disrupt other equipment; and they direct the flow of cooling air through the chassis. Do not operate the system unless all cards, faceplates, front covers, and rear covers are in place. Statement 1029

Warning: A ground wire must always be a single piece of wire. Never splice two wires together for a ground. Corrosion and weathering can lead to a poor connection at the splice, making the ground ineffective and dangerous. Statement 270

Warning: To reduce the risk of fire, use only No. 26 AWG or larger telecommunication line cord. Statement 1023

Warning: Use copper conductors only. Statement 1025

Warning: A readily accessible two-poled disconnect device must be incorporated in the fixed wiring. Statement 1022

Warning: Invisible laser radiation may be emitted from the end of the unterminated fiber cable or connector. Do not view directly with optical instruments. Viewing the laser output with certain optical instruments (for example, eye loupes, magnifiers, and microscopes) within a distance of 100 mm may pose an eye hazard. Statement 1056

Warning: To prevent the system from overheating, do not operate it in an area that exceeds the maximum recommended ambient temperature of: 60° C (140° F). Statement 1047

Warning: Hot surface. Statement 1079

Caution: Heat sinks applicable to warning statement 1079, can exceed 90° C in a 60° C ambient. Suitable precautions should be taken to avoid burns.

Warning: This equipment needs to be grounded. Use a green and yellow 12 to 14 AWG ground wire to connect the host to earth ground during normal use. Statement 242

What you Need to Know

CLI Console Access

Use the new USB console port on the router to access the Cisco Internet Operating System (IOS) Command Line Interface (CLI) on the router and perform configuration tasks. A terminal emulation program, such as Microsoft Windows HyperTerminal, is required to establish communication between the router and a PC. See [Connecting to a Console Terminal or Modem, page 38](#).

Note: A Microsoft Windows USB driver must be installed before you establish physical connectivity between the router and the PC.

Slot and Port Numbers

Cisco CGR 2010 routers have built-in ports and new slots. The new slots accommodate new grid router WAN interface cards (GRWICs). See [Slot, Port, and Interface Information, page 11](#) for slot and port numbering

Before You Begin

Before installing and connecting a Cisco CGR 2010 router, read the safety warnings and gather the following tools and equipment:

- ESD-preventive cord and wrist strap
- Number 2 Phillips screwdriver
- Flat-blade screwdrivers: small, 3/16-in. (4 to 5 mm) and medium, 1/4-in. (6 to 7 mm)
 - To install or remove GRWICs
 - To remove the cover, if you are upgrading memory or other components
- Screws that fit your rack

In addition, depending on the type of modules you plan to use, you might need the following equipment to connect a port to an external network:

- Cables for connection to the WAN and LAN ports (dependent on configuration).

For more information on cable specifications, see [Cisco Modular Access Router Cable Specifications](#) on www.cisco.com.

- Ethernet hub or PC with a network interface card for connection to an Ethernet (LAN) port.
- Console terminal (an ASCII terminal or a PC running HyperTerminal or similar terminal emulation software) configured for 9600 baud, 8 data bits, 1 stop bit, no flow control, and no parity.
- Modem for connection to the auxiliary port for remote administrative access (optional).
- Data service unit (DSU) or channel service unit/data service unit (CSU/DSU) as appropriate for serial interfaces.
- External CSU for any CT1/PRI modules without a built-in CSU.
- NT1 device for ISDN BRI S/T interfaces (if not supplied by your service provider).

Caution: Sites with ambient temperatures consistently above 25 degrees C (77 degrees F) and with potentially high levels of dust or debris may require periodic preventative maintenance cleaning.

Unpacking the Router

Do not unpack the router until you are ready to install it. If the final installation site will not be ready for some time, keep the chassis in its shipping container to prevent accidental damage. When you are ready to install the router, proceed with unpacking it.

The router, accessory kit, publications, and any optional equipment you ordered may be shipped in more than one container. When you unpack the containers, check the packing list to ensure that you received all of the items on the list.

Installing the Router in a Rack

The Cisco CGR 2010 router can only be mounted in a rack.

Caution: To prevent damage to the chassis, never attempt to lift or tilt the chassis by holding it by the plastic panel on the front. Always hold the chassis by the sides of the metal body.

Note: Allow at least one rack unit of vertical space above the router.

Rack-Mounting the Chassis

The Cisco CGR 2010 router can be installed in a 19-inch (48.26-cm) standard rack.

You can mount the router in the following ways:

- Power-supply side mounting—Brackets attached at the power supply side of the chassis with the power-supply side facing forward.
- Cable-side mounting—Brackets attached at the cable side of the chassis with the cable side facing forward.

Figure 1 on page 28 shows the rack-mount brackets used with the Cisco CGR 2010 router.

Figure 1 Rack-Mount Brackets for the Cisco CGR 2010 Router

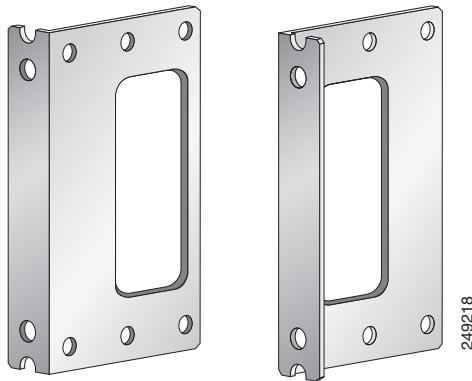

Attaching Rack-Mount Brackets to Cisco CGR 2010 Routers

To attach the long side of each bracket to the Cisco CGR 2010 router, use four of the supplied number-8 Phillips flat-head screws.

Figure 2 on page 28 shows how to attach the brackets to the sides of the router with the power-supply side forward.

Figure 2 Bracket Installation for Power-Supply Side Mounting

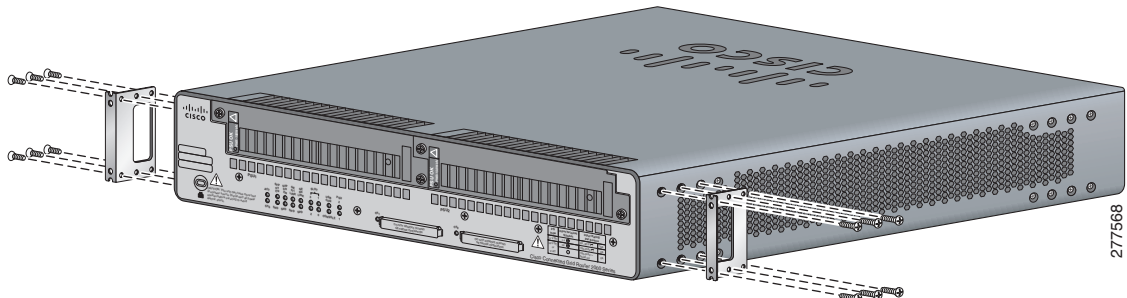
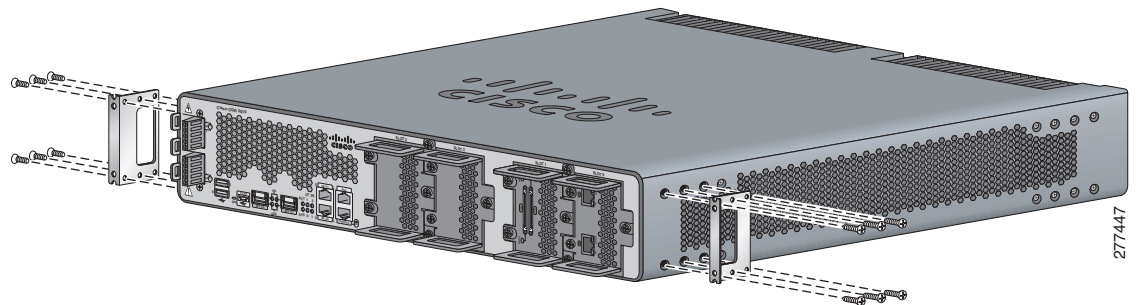

Figure 3 on page 29 shows how to attach the brackets to the sides of the router with the cable-side forward.

Figure 3 Bracket Installation for Cable-Side Mounting

Caution: Do not over-torque the screws. The recommended torque is 15 to 18 inch-lb (1.7 to 2.0 N-m).

Attach the second bracket to the opposite side of the chassis. Use a number 2 Phillips screwdriver to install the number-8 bracket screws.

Caution: Your chassis installation must allow unrestricted airflow for chassis cooling.

Mounting the Router in a Rack

After you attach the rack-mount brackets to the router chassis, use the screws provided with the rack to install the chassis in the rack. See [Figure 4 on page 30](#)

Note: The screw slots in the brackets are spaced to line up with every *second* pair of screw holes in the rack. When the correct screw holes are used, the small threaded holes in the brackets line up with unused screw holes in the rack. If the small holes do not line up with the rack holes, you must raise or lower the brackets to the next rack hole.

Caution: A space of 1 RU above each Cisco CGR 2010 router is required for sufficient air ventilation.

[Figure 4 on page 30](#) shows a typical installation in a rack.

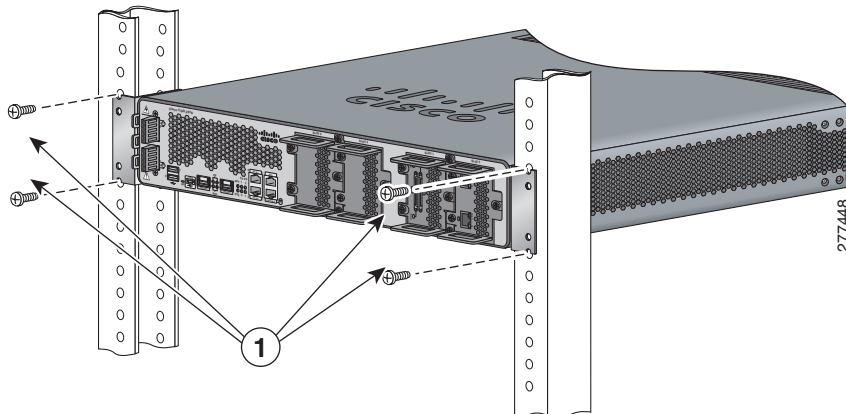
Figure 4 Mounting the Chassis in a Rack (Typical Installation)

- 1 Mounting screws (4)

Power-Supply Modules

This section describes how to connect AC power and DC power to the Cisco CGR 2010 router. This section also describes how to protect the Cisco CGR 2010 router terminal block from exposure with the terminal block cover and shut off power.

[Table 1 on page 30](#) summarizes the three power-supply modules available for the Cisco CGR 2010 router.

Table 1 Power-Supply Modules

Model	Description	Voltage Range
PWR-RGD-AC-DC	High-voltage AC or DC.	100-240VAC 100-250VDC
PWR-RGD-LOW-DC	Low-voltage DC.	24-60VDC 10 amps
PWR-RGD-AC-DC-C	High-voltage AC or DC. China-specific model.	100-240VAC 100-250VDC

See [Figure 5 on page 31](#).

Figure 5 Cisco CGR 2010 Router Power Supply Inserted Into the Router

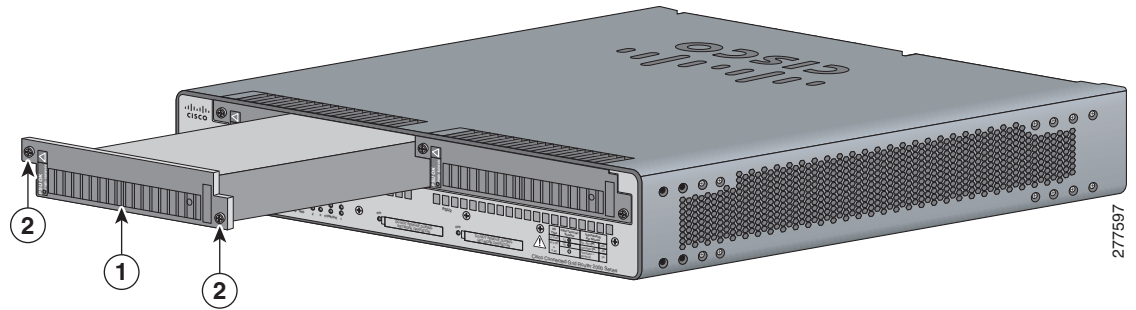

1 Power supply

2 Power supply captive screws

Connecting AC Power

This section explains how to connect AC power to the Cisco CGR 2010 router.

Warning: Read the installation instructions before connecting the system to the power source. Statement 1004

To connect an AC power supply:

1. Verify that power is off to the circuit on the power supply that you are removing. As an added precaution, place the appropriate safety flag and lockout devices at the source power circuit breaker, or place a piece of adhesive tape over the circuit breaker handle to prevent accidental power restoration while you are working on the circuit.
2. Observe the power-input terminal on the left edge of the router's cable side. See [Figure 6 on page 32](#)

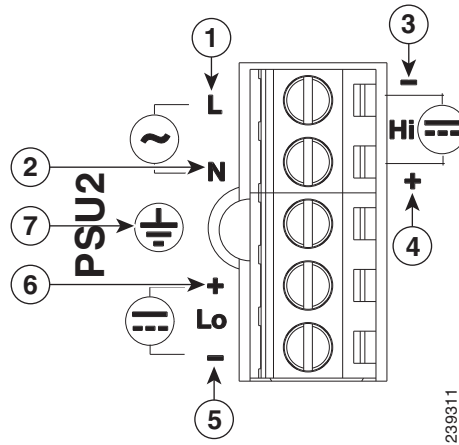
Figure 6 Power-Input Terminal Designations

- | | | | |
|---|---|---|---|
| 1 | Line connection for AC power ¹ | 4 | Positive connection for high-voltage DC |
| 2 | Neutral connection for AC power | 5 | Negative connection for low-voltage DC |
| 3 | Negative connection for high-voltage DC | 6 | Positive connection for low-voltage DC |
| 7 | Ground connection | | |

¹ Note that the line connection for AC power and the negative connection for high-voltage DC power share the same power input terminal—that is, this terminal can be used for either AC or DC power. The same is true for the terminal for the neutral connection for AC power and the positive connection for high-voltage DC power—the same terminal can be used for either AC or DC power.

Note: The power-supply module 1 connection is labeled PSU1, and the power-supply module 2 connection is labeled PSU2. Ensure that you connect the wires to the correct terminal screws.

- Use twisted-pair copper wire to connect from the power-input terminal to the power source.

Note: Use 12-AWG (minimum) for the low-voltage DC power supply module. Use 14-AWG (minimum) or 12-AWG (maximum) for the high-voltage DC or AC power supply module.

- Strip each of the two wires to 0.25 inch (6.3 mm) \pm 0.02 inch (0.5 mm). See [Figure 7 on page 32](#)

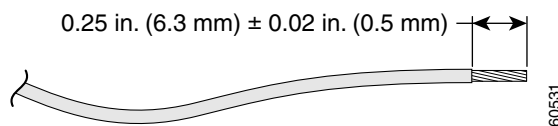
Figure 7 Stripping the Input Power Source Wire

Note: Do not strip more than 0.27 inch (6.8 mm) of insulation from the wire. Stripping more than the recommended amount of wire can leave exposed wire from the connector after installation.

- To connect AC power:

Warning: When installing or replacing the unit, the ground connection must always be made first and disconnected last. Statement 1046

- Connect the Ground wire (the green or green/yellow lead of the cable) into the terminal marked *with the* ground symbol. See item 7 in [Figure 6 on page 32](#)
- Connect the Line wire (the black or brown lead of the cable) into the terminal screw labeled *L*. See item 1 in [Figure 9 on page 34](#).

- c. Connect the Neutral wire (the white or blue lead of the cable) into the terminal screw labeled *N*. See item 2 in [Figure 9 on page 34](#).

Note: Ensure that you cannot see any wire lead. Only wire *with insulation* should extend from the terminal screw.

- d. Use a tie wrap to secure the cable to the central strain relief tab next to the terminal block on the chassis. Secure the cable immediately adjacent to the terminal block to minimize strain on the cable.

The strain relief mechanism consists of three metal loops built into the chassis next to the terminal block. See [Figure 8 on page 33](#).

Note: Do not overtighten the tie wrap to the loops. This could damage the wiring insulation. An overtightened tie wrap could cause cold-flow of the wire insulation, which in turn could cause shorting of the power source to the chassis.

Figure 8 Using Tie Wraps with the Strain Relief Mechanism

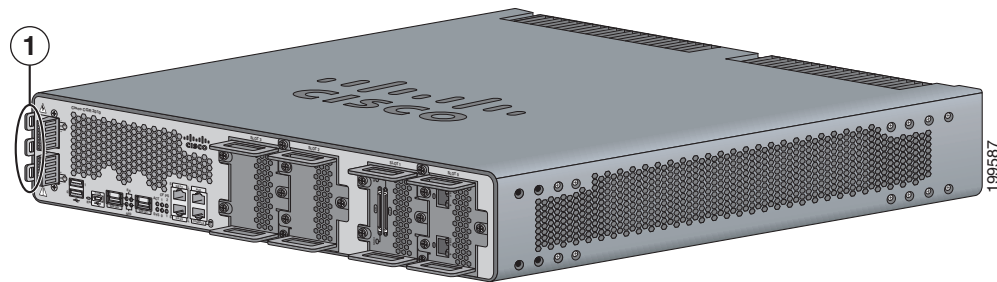

- 1 Tie wraps to the central strain relief tab.

Caution: Ensure that all strands of a stranded wire are properly captured into the terminal block. A loose strand could possibly short the chassis and result in a hazard.

- e. Use minimum 14 AWG or maximum 12 AWG copper wire to connect the router to a 15 A branch circuit in accordance with local electrical code requirements.
6. Fully insert the un-insulated lead in to the terminal block and screw each captive screw on the terminal block tight to ensure proper connection.

Caution: The AWG size of the wires feeding power to the input terminal block is a minimum of 14 AWG (2.0 mm²) or a maximum of 12 AWG (3.309 mm²), all for a 15 Amp branch circuit. 12 AWG is the largest wire that the terminal block will accept.

7. Torque the captive screws (above the wires) to 8.5 in-lb (\pm 0.5 in-lb).

Caution: Do not touch the terminal block when energy is restored. The terminal block screw heads and any exposed wiring could have hazardous line voltages (depending on the voltage source). The Cisco CGR 2010 router is intended to be installed in a restricted access location and serviced by trained personnel only.

8. Connect the other end of the line wire (the wire connected to *L*) to the line terminal on the AC power source.
9. Connect the other end of the neutral wire (the wire connected to *N*) to the neutral terminal on the AC power source.
10. Turn on the power at the AC circuit, then verify that the following LEDs are green:
 - On the power-supply module: *PSU OK* LED. See [Figure 6 on page 12](#)
 - On the router: *PSU1* (bottom) or *PSU2 LED* (top). See [Figure 6 on page 12](#)

- Verify that the voltage at the router is within the rated operating voltage range of the product by using a meter or issuing the **show environment** command. *For normal operating voltages, see Table 1 on page 30*
11. If you have two power supplies, install the second power supply in the available slot and repeat Step 1 through Step 10.

Connecting DC Power

This section explains how to connect DC power to the Cisco CGR 2010 router.

Warning: Read the installation instructions before connecting the system to the power source. **Statement 1004**

To connect an DC power supply:

1. Verify that power is off to the circuit on the power supply that you are removing. As an added precaution, place the appropriate safety flag and lockout devices at the source power circuit breaker, or place a piece of adhesive tape over the circuit breaker handle to prevent accidental power restoration while you are working on the circuit.
2. Observe the power-input terminal on the left edge of the router cable side. See [Figure 9 on page 34](#).

Figure 9 Power-Input Terminal Designations

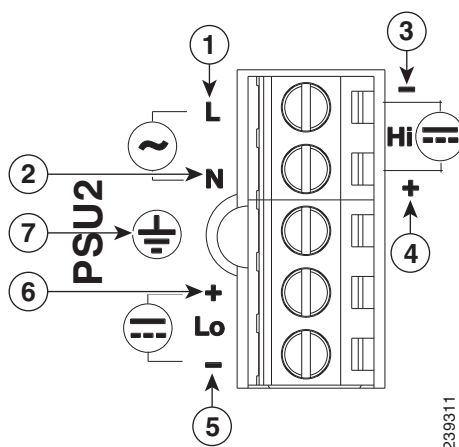

- | | | | |
|---|---|---|---|
| 1 | Line connection for AC power ¹ | 4 | Positive connection for high-voltage DC |
| 2 | Neutral connection for AC power | 5 | Negative connection for low-voltage DC |
| 3 | Negative connection for high-voltage DC | 6 | Positive connection for low-voltage DC |
| 7 | Ground connection | | |

¹ Note that the line connection for AC power and the negative connection for high-voltage DC power share the same power input terminal—that is, this terminal can be used for either AC or DC power. The same is true for the terminal for the neutral connection for AC power and the positive connection for high-voltage DC power—the same terminal can be used for either AC or DC power.

Note: The power-supply module 1 connection is labeled PSU1, and the power-supply module 2 connection is labeled PSU2. Ensure that you connect the wires to the correct terminal screws.

3. Use twisted-pair copper wire to connect from the power-input terminal to the power source.

Note: Use 12-AWG (minimum) for the low-voltage DC power supply module. Use 14-AWG (minimum) or 12-AWG (maximum) for the high-voltage DC or AC power supply module.

4. Strip each of the two wires to 0.25 inch (6.3 mm) ± 0.02 inch (0.5 mm). See [Figure 10 on page 35](#).

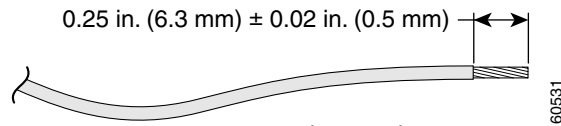
Figure 10 Stripping the Input Power Source Wire

Note: Do not strip more than 0.27 inch (6.8 mm) of insulation from the wire. Stripping more than the recommended amount of wire can leave exposed wire from the connector after installation.

5. To connect DC power:

Warning: When installing or replacing the unit, the ground connection must always be made first and disconnected last. **Statement 1046**

- a. Connect the Ground wire (the green or green/yellow lead of the cable) into the terminal marked *with the* ground symbol. See item 7 in [Figure 9 on page 34](#).
- b. Connect the Positive wire into the terminal screw labeled +.
- c. Connect the Negative wire into the terminal screw labeled -.

Note: Ensure that you cannot see any wire lead. Only wire *with insulation* should extend from the terminal screw.

Note: If you have a **low-voltage DC power-supply module**, connect the wires to the terminals labeled *Lo*. See items 5 and 6 in [Figure 9 on page 34](#).

If you have a **high-voltage DC power-supply module**, connect the wires to the terminals labeled *Hi*. See items 3 and 4 in [Figure 9 on page 34](#).

Caution: Do not use a power cable to connect the chassis low-voltage DC input to a voltage source. If you inadvertently plug a cable into a 120 VAC source, the low-voltage supply will be damaged and hazard could result.

If you need a cable to connect to the low-voltage DC power supply, cut off the plug from the power cord and hard-wire the Cisco CGR 2010 low-voltage DC input directly to its power source, observing the correct polarity markings.

- d. Use a tie wrap to secure the cable to the central strain relief tab next to the terminal block on the chassis. Secure the cable immediately adjacent to the terminal block to minimize strain on the cable.

The strain relief mechanism consists of three metal loops built into the chassis next to the terminal block. See [Figure 11 on page 36](#).

Note: Do not overtighten the tie wrap to the loops, which could damage the wiring insulation. An overtightened tie wrap could cause cold-flow of the wire insulation, which in turn could cause shorting of the power source to the chassis.

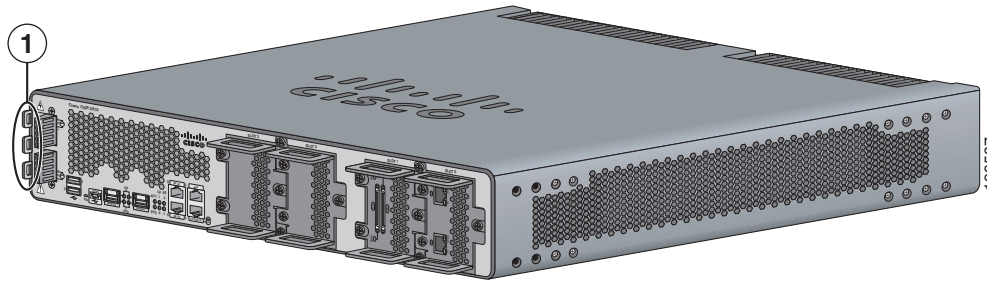
Figure 11 Using Tie Wraps with the Strain Relief Mechanism

- 1 Tie wraps to the central strain relief tab.

Caution: Ensure that all strands of a stranded wire are properly captured into the terminal block. A loose strand could possibly short the chassis and result in a hazard.

- e. Use minimum 14-AWG or maximum 12-AWG copper wire to connect the router to a 15-A branch circuit in accordance with local electrical code requirements.
6. Fully insert the un-insulated lead in to the terminal block and screw each captive screw on the terminal block tight to ensure proper connection.

Caution: The AWG size of the wires feeding power to the input terminal block is a minimum of 14 AWG (2.0 mm²) or a maximum of 12 AWG (3.309 mm²), all for a 15 Amp branch circuit. 12 AWG is the largest wire that the terminal block will accept.

7. Torque the captive screws (above the wires) to 8.5 in-lb (± 0.5 in-lb).

Caution: Do not touch the terminal block after energy is restored. The terminal block screw heads and any exposed wiring could have hazardous line voltages (depending on the voltage source). The Cisco CGR 2010 router is intended to be installed in a restricted access location and serviced by trained personnel only.

8. Connect the other end of the positive wire (the wire connected to +) to the positive terminal on the DC power source.
9. Connect the other end of the negative wire (the wire connected to -) to the negative terminal on the DC power source.
10. Turn on the power at the DC circuit, then verify that the following LEDs are green:
 - On the power-supply module: *PSU OK* LED. See [Figure 6 on page 12](#).
 - On the router: *PSU1* (bottom) or *PSU2 LED* (top). See [Figure 6 on page 12](#).
 - Verify that the voltage at the router is within the rated operating voltage range of the product by using a meter or issuing the **show environment** command. For normal operating voltages, see [Table 1 on page 30](#).
11. If you have two power supplies, install the second power supply in the available slot and repeat Step 1 through Step 10.

Protecting the Terminal Block from Exposure

You can protect the Cisco CGR 2010 router terminal block from exposure with the terminal block cover. See [Figure 12 on page 37](#).

Note: The terminal block cover is intended to protect against inadvertent contact with the exposed terminals of the input terminal block. The terminal block cover does not comply with the safety standard requirements for enclosures. Consequently, even with the terminal block cover installed, the CGR 2010 router still needs to be located in a restricted access location, accessible only by trained service personnel who recognize the hazards in that environment and are trained to take the necessary precautions.

Figure 12 CGR 2010 Power Terminal Cover

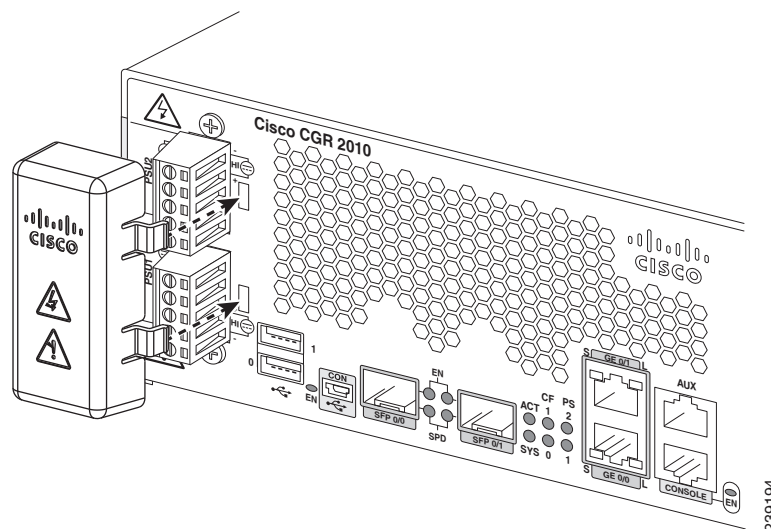

To attach the CGR 2010 terminal block cover:

1. Access the cable side of the router.
2. Locate the terminal blocks on the left side of the chassis.
3. To secure the terminal block cover, first insert the two clips on the right side, then insert the single clip on the left side, as shown in [Figure 12 on page 37](#).
4. You can funnel cables into the terminal block through the cable routing holes on the left side of the cover.

Shutting Off Power

Even though shutting off power to the Cisco CGR 2010 router is anticipated to be infrequent, there may be occasion to turn off the router. There is no on/off switch on the Cisco CGR 2010 router. This ensures that there will not be any accidental shutdown due to inadvertently turning off a power switch; thus, guaranteeing a high reliability in keeping the router up. To shut off power to the router, there are two options:

- Pull the power supply modules out of the Cisco CGR 2010 router. See [Replacing Power Supplies and Redundant Power Supplies, page 38](#).

The power supplies on the Cisco CGR 2010 router are hot swappable, so merely removing them from the router will remove power from the router and shut it down.

- Install a disconnect device for the Cisco CGR 2010 router.

A disconnect device must be located in the proximity of the Cisco CGR 2010 router and must be readily accessible. The disconnect device must also comply with IEC 60947-1 and IEC 60947-3 or an equivalent approved disconnect device appropriate for the country of installation and be identified as the disconnect device for this equipment.

Note: The maximum current rating for the power disconnect circuit breaker or overcurrent device must be 15 Amps. Operational power must be internally fused. This fuse cannot be replaced by the user. In the event of the disconnect device failing, return the unit to the factory for repair.

Replacing Power Supplies and Redundant Power Supplies

Before you perform power supply replacement, read the [Safety Warnings, page 77](#) and disconnect power when noted.

The Cisco CGR 2010 routers have replaceable power supplies. Use a Number 2 Phillips screwdriver to remove or install the power supply.

Caution: Any combination of power supplies can be inserted into the chassis. Dual power supply configurations are load sharing in redundancy mode.

A single power supply is sufficient for supporting power needs to the system. A single PSU can be deployed in either slot 1 (PSU1) or slot 2 (PSU2).

Note: The power supplies are hot swappable. The power supply LED must show it is properly functioning before removing the other power supply in the router.

Replacing the Cisco CGR 2010 Router Power Supply

For the following steps see [Figure 13 on page 38](#) for the locations of connectors and other components within the Cisco CGR 2010 router.

To replace the power supply in a Cisco CGR 2010 router:

1. Loosen the captive screws that fasten the power supply to the chassis.
2. Pull the power supply out of the chassis. See [Figure 13 on page 38](#).

Figure 13 Removing the Cisco CGR 2010 Router Power Supply

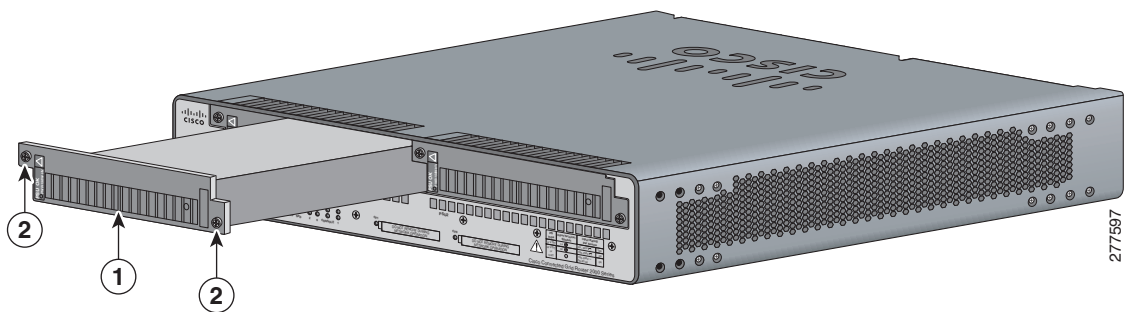

- | | | | |
|---|--------------|---|-----------------------------|
| 1 | Power supply | 2 | Power supply captive screws |
|---|--------------|---|-----------------------------|

3. Insert the replacement power supply into the chassis. See [Figure 13 on page 38](#).
4. Tighten the captive screws that fasten the power supply to the chassis.

Connecting to a Console Terminal or Modem

The router has asynchronous serial ports and auxiliary ports. These ports provide administrative access to the router either locally (with a console terminal or a PC) or remotely (with a modem). To configure the router through the Cisco IOS command-line interface (CLI), you must establish a connection between the router console port and either a terminal or a PC.

Table 2 on page 39 shows cables and adapters to establish a local or remote connection.

Table 2 Local and Remote Connections

Port Type	Cable	Section
Serial (RJ-45)	EIA RJ-45	Connecting to the Serial Port with Microsoft Windows, page 39
Serial (USB)	USB 5-pin mini USB Type-B-to-USB Type-A	
Auxiliary (Modem)	DB-9-to-DB-25	Connecting to the Auxiliary Port, page 43

Connecting to the Serial Port with Microsoft Windows

This section describes using Microsoft Windows to connect to the serial port.

Note: Install the USB device driver before establishing a physical connection between the router and the PC using the USB console cable plugged into the USB serial port, otherwise the connection will fail. See [Installing the Cisco Microsoft Windows USB Device Driver, page 41](#).

1. Connect the end of the console cable with the RJ-45 connector to the light blue console port on the router.

or

Connect a USB 5-pin mini USB Type-B to the USB console port, as shown in [Figure 14 on page 40](#). If you are using the USB serial port for the first time on a Windows-based PC, install the USB driver now according to the instructions in the following sections.

[Installing the Cisco Microsoft Windows XP USB Driver, page 41](#)

[Installing the Cisco Microsoft Windows 2000 USB Driver, page 42](#)

[Installing the Cisco Microsoft Windows Vista USB Driver, page 42](#)

Note: You cannot use the USB port and the EIA port concurrently. See [Connecting to the Auxiliary Port, page 43](#). When the USB port is used, it takes priority over the RJ-45 EIA port.

2. Connect the end of the cable with the DB-9 connector (or USB Type-A) to the terminal or PC. If your terminal or PC has a console port that does not accommodate a DB-9 connector, you must provide an appropriate adapter for that port.

Note: To identify the COM port assigned to the USB console port, use the Control Panel to open the Device Manager, and expand the Ports section. The assigned COM port is shown in parenthesis at the end of the line with the following entry: Cisco USB System Management Console.

3. To communicate with the router, start a terminal emulator application, such as Microsoft Windows HyperTerminal. This software should be configured with the following parameters:
 - 9600 baud
 - 8 data bits
 - no parity
 - 1 stop bit
 - no flow control

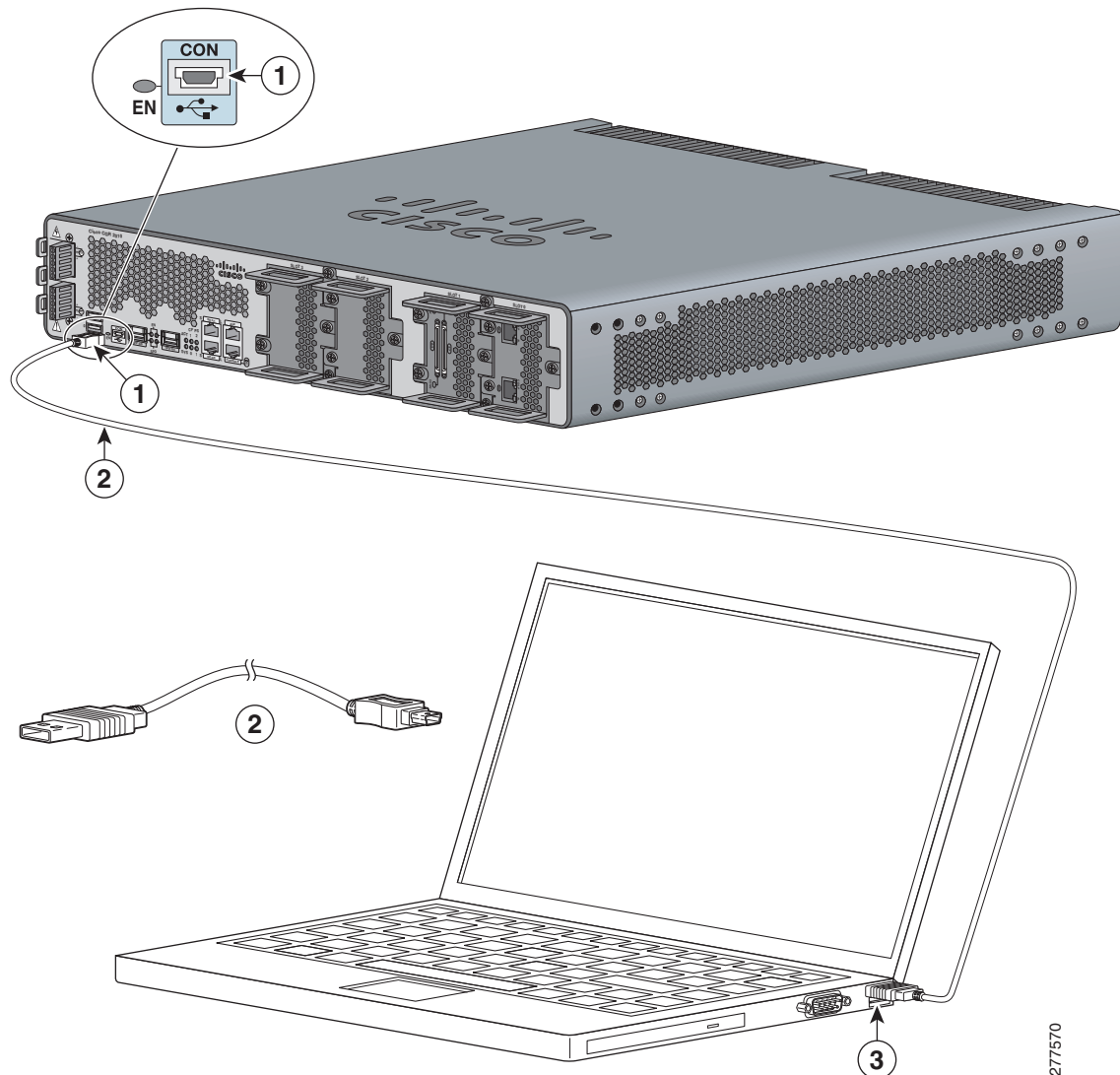
Figure 14 Connecting the USB Console Cable to the Cisco CGR 2010 Router

- 1 USB 5-pin mini USB type-B console port 2 USB 5-pin mini USB type-B to USB type-A console cable
 3 USB Type-A

Connecting to the Console Port with Mac OS X

To connect a Mac OS X system USB port to the console using the built-in OS X Terminal utility:

1. Use the Finder to go to **Applications > Utilities > Terminal**.
2. Connect the OS X USB port to the router.
3. Enter the following commands to find the OS X USB port number:

```
macbook:user$ cd /dev
macbook:user$ ls -ltr /dev/*usb*
crw-rw-rw-  1 root   wheel   9,  66 Apr  1 16:46 tty.usbmodem1a21
DT-macbook:dev user$
```

4. Connect to the USB port with the following command followed by the router USB port speed:

```
macbook:user$ screen /dev/tty.usbmodem1a21 9600
```

5. To disconnect the OS X USB console from the terminal window:

- a. Enter **Ctrl+A** followed by **Ctrl+**

Connecting to the Console Port with Linux

To connect a Linux system USB port to the console using the built-in Linux Terminal utility:

1. Open the Linux Terminal window.
2. Connect the Linux USB port to the router.
3. Enter the following commands to find the Linux USB port number:

```
root@usb-suse# cd /dev
root@usb-suse /dev# ls -ltr *ACM*
crw-r--r-- 1 root root 188, 0 Jan 14 18:02 ttyACM0
root@usb-suse /dev#
```

4. Connect to the USB port with the following command followed by the router USB port speed:

```
root@usb-suse /dev# screen /dev/ttyACM0 9600
```

5. To disconnect the Linux USB console from the terminal window:

- a. Enter **Ctrl+A** followed by **;**, and then type **quit**.

Installing the Cisco Microsoft Windows USB Device Driver

A USB device driver must be installed the first time a Microsoft Windows-based PC is connected to the USB serial port on the router.

These topics are discussed:

- [Installing the Cisco Microsoft Windows XP USB Driver, page 41](#)
- [Installing the Cisco Microsoft Windows 2000 USB Driver, page 42](#)
- [Installing the Cisco Microsoft Windows Vista USB Driver, page 42](#)

Installing the Cisco Microsoft Windows XP USB Driver

To install the Microsoft Windows XP USB driver:

1. Obtain the file *Cisco_usbconsole_driver.zip* from www.cisco.com website and unzip it.
2. If using 32-bit Windows XP, double-click the *setup.exe* file from the *Windows_32* folder. If using 64-bit Windows XP, double-click the *setup(x64).exe* file from the *Windows_64* folder.
3. The Cisco Virtual Com InstallShield Wizard begins. Click **Next**.
4. The Ready to Install the Program window appears. Click **Install**.
5. The InstallShield Wizard Completed window appears. Click **Finish**.
6. Connect the USB cable to the PC and router USB console ports. See [Table 2 on page 39](#).

Uninstalling the Cisco Microsoft Windows USB Driver

The EN LED for the USB console port turns green, and the Found New Hardware wizard appears.

7. Follow the Found New Hardware wizard instructions to complete the installation of the driver.

The USB console is now ready for use.

Installing the Cisco Microsoft Windows 2000 USB Driver

To install the Microsoft Windows 2000 USB driver:

1. Obtain the file *Cisco_usbconsole_driver.zip* from www.cisco.com and unzip it.
2. Double-click the file *setup.exe*.
3. The Cisco Virtual Com InstallShield Wizard begins. Click **Next**.
4. The Ready to Install the Program window appears. Click **Install**.
5. The InstallShield Wizard Completed window appears. Click **Finish**.
6. Connect the USB cable to the PC and router USB console ports. See [Table 2 on page 39](#).

The EN LED for the USB console port turns green, and the Found New Hardware wizard appears.

7. Follow the Found New Hardware wizard instructions to complete the installation of the driver.

The USB console is now ready for use.

Installing the Cisco Microsoft Windows Vista USB Driver

To install the Microsoft Windows Vista USB driver:

1. Obtain the file *Cisco_usbconsole_driver.zip* from www.cisco.com and unzip it.
 2. If using 32-bit Windows Vista, double-click the *setup.exe* file from the *Windows_32* folder, or if using 64-bit Windows Vista, double-click the *setup(x64).exe* file from the *Windows_64* folder.
 3. The Cisco Virtual Com InstallShield Wizard begins. Click **Next**.
 4. The Ready to Install the Program window appears. Click **Install**.
- Note:** If a User Account Control warning appears, click “Allow - I trust this program...” to proceed.
5. The InstallShield Wizard Completed window appears. Click **Finish**.

6. Connect the USB cable to the PC and router USB console ports. See [Table 2 on page 39](#).

The EN LED for the USB console port turns green, and a pop-up window is displayed stating “Installing device driver software.”

7. Follow the instructions to complete the installation of the driver.

The USB console is ready for use.

Uninstalling the Cisco Microsoft Windows USB Driver

This section provides instructions for how to uninstall the Cisco Microsoft Windows USB device driver.

- [Uninstalling the Cisco Microsoft Windows XP and 2000 USB Driver, page 43](#)

- [Uninstalling the Cisco Microsoft Windows Vista USB Driver, page 43](#)

Uninstalling the Cisco Microsoft Windows XP and 2000 USB Driver

You can remove Microsoft Windows XP and the 2000 USB driver using the Windows Add or Remove Programs utility or the setup.exe program.

To uninstall both the Microsoft Windows XP and 2000 USB driver using the Add Remove Programs utility:

Note: Disconnect the router console terminal before uninstalling the driver.

1. Click **Start > Control Panel > Add or Remove Programs**.
2. Scroll to Cisco Virtual Com and click **Remove**.
3. When the Program Maintenance window appears, select the **Remove** radio button, then click **Next**.

To uninstall both the Microsoft Windows XP and 2000 USB driver using the Setup.exe program:

Note: Disconnect the router console terminal before uninstalling the driver.

1. Run the setup.exe for Windows 32-bit or setup(x64).exe for Windows-64bit. Click **Next**.
2. The InstallShield Wizard for Cisco Virtual Com appears. Click **Next**.
3. When the Program Maintenance window appears, select the **Remove** radio button, then click **Next**.
4. When the Remove the Program window appears, click **Remove**.
5. When the InstallShield Wizard Completed window appears, click **Finish**.

Uninstalling the Cisco Microsoft Windows Vista USB Driver

To uninstall the Microsoft Windows Vista USB driver:

Note: Disconnect the router console terminal before uninstalling the driver.

1. Run the *setup.exe* file for Windows 32-bit or the *setup(x64).exe* file for Windows 64-bit. Click **Next**.
2. The InstallShield Wizard for Cisco Virtual Com appears. Click **Next**.
3. When the Program Maintenance window appears, select the **Remove** radio button, then click **Next**.
4. When the Remove the Program window appears, click **Remove**.

Note: If a User Account Control warning appears, click "Allow - I trust this program..." to proceed.

5. When the InstallShield Wizard Completed window appears, click **Finish**.

Connecting to the Auxiliary Port

When a modem is connected to the auxiliary port, a remote user can dial in to the router and configure it.

To connect a modem to the router:

1. Connect the RJ-45 end of the adapter cable to the black AUX port on the router ([Figure 15 on page 44](#)).

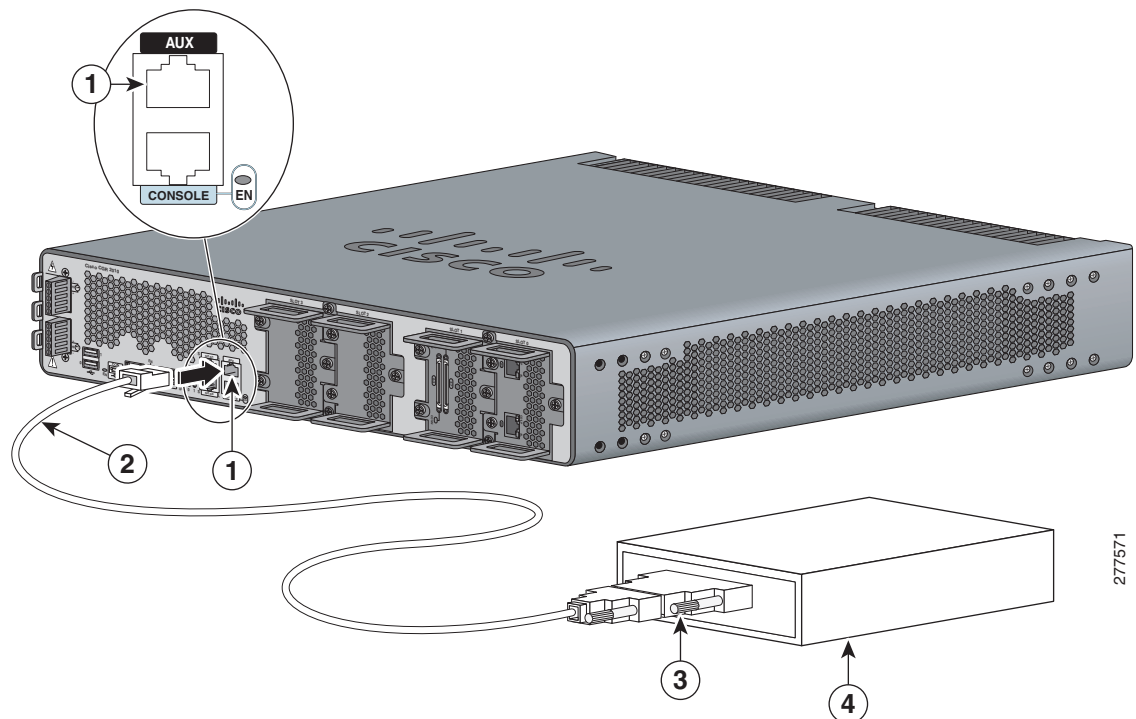
Figure 15 Connecting a Modem to the Cisco CGR 2010 Router

- | | | | |
|---|-----------------------|---|---------------------|
| 1 | RJ-45 AUX port | 2 | RJ-45-to-DB-9 cable |
| 3 | DB-9-to-DB-25 adapter | 4 | Modem |

2. Connect the DB-9 end of the console cable to the DB-9 end of the modem adapter.
3. Connect the DB-25 end of the modem adapter to the modem.
4. Ensure that your modem and the router auxiliary port are configured for the same transmission speed (up to 115200 bps is supported) and for mode control with data carrier detect (DCD) and data terminal ready (DTR) operations.

Connecting WAN and LAN Interfaces

This section describes how to connect WAN and LAN interface cables.

Note: One or two Ethernet cables are typically provided with the router. Additional cables and transceivers can be ordered from Cisco. For ordering information, contact customer service. For cable pinouts, see [Cisco Modular Access Router Cable Specifications](#).

Warning: Do not work on the system or connect or disconnect cables during periods of lightning activity. Statement 1001

Warning: To avoid electric shock, do not connect safety extra-low voltage (SELV) circuits to telephone-network voltage (TNV) circuits. LAN ports contain SELV circuits, and WAN ports contain TNV circuits. Some LAN and WAN ports both use RJ-45 connectors. Use caution when connecting cables. Statement 1021

Warning: Hazardous network voltages are present in WAN ports regardless of whether power to the unit is OFF or ON. To avoid electric shock, use caution when working near WAN ports. When detaching cables, detach the end away from the unit first. Statement 1026

Connection Procedures and Precautions

To properly connect cables:

1. Connect each WAN and LAN cable to the appropriate connector on the chassis or on an interface card.
2. Position the cables carefully, so that they do not put strain on the connectors.
3. Organize cables in bundles so that cables do not intertwine.
4. Inspect the cables to make sure that the routing and bend radius is satisfactory. Reposition cables, if necessary.

Note: Install cable ties in accordance with site requirements.

For cable pinouts, see [Cisco Modular Access Router Cable Specifications](#) on www.cisco.com.

Ports and Cabling

Table 3 on page 45 summarizes typical WAN and LAN connections for Cisco CGR 2010 routers. The connections summarized here are also described in detail in [Cisco Modular Access Router Cable Specifications](#).

Table 3 WAN, LAN, and Voice Connections

Port or Connection	Port Type, Color ¹	Connection:	Cable
Ethernet	RJ-45, yellow	Ethernet hub or Ethernet switch	Category 5 or higher Ethernet
T1/E1 WAN	RJ-48C/CA81A	T1 or E1 network	RJ-48 T1/E1 ²
Cisco serial	60-pin D-sub, blue	CSU/DSU and serial network or equipment	Cisco serial transition cable that matches the signaling protocol (EIA/TIA-232, V.35 or X.21 and the serial port operating mode (DTE or DCE). ³
Cisco Smart serial	Cisco Smart compact connector, blue	CSU/DSU and serial network or equipment	
56/64-kbps DSU/CSU	8-pin modular, blue	RJ-48S interface in subrate device or network	RJ-48 straight-through
T1/FT1 DSU/CSU	8-pin modular, blue	RJ-48C interface	RJ-48 straight-through
Gigabit Ethernet SFP, optical	LC, color according to optical wavelength	1000BASE-SX, -LX, -ZX, 100BASE-FX and 100BASE-LX	Optical fiber as specified on applicable data sheet
Gigabit Ethernet SFP, copper	RJ-45	1000BASE-T	Category 5, 5e, 6 UTP

¹ Cable color codes are specific to Cisco cables.

² For T1/E1 interfaces, shielded cables are required to meet EN55022, Cisp 22, and EN300-386 compliance.

³ See [Cisco Modular Access Router Cable Specifications](#) for information about choosing these cables.

Auxiliary Port, Console Port, and Adapter Pinouts for the Cisco CGR 2010 Router

This section explains the different ports and adapter pinouts available for the Cisco CGR 2010 router.

Auxiliary and Console Ports

The console and auxiliary ports on Cisco IOS® routers are asynchronous serial ports. The console port and the auxiliary port are configured as data terminal equipment (DTE). For Cisco 2000 Series Routers, the console and auxiliary ports both use RJ-45 connectors. Adapters are available for connections to PC terminals, modems, or other external communications equipment.

[Table 4 on page 46](#) shows the console port pinouts for the RJ-45 connector. Any pin not referenced is not connected.

Table 4 Console Port Pinouts for the RJ-45 Connector

Console Port (DTE)		
Pin	Signal	Input/Output
1	-	-
2	DTR	Output
3	TxD	Output
4	GND	-
5	GND	-
6	RxD	Input
7	DSR	Input
8	-	-

[Table 5 on page 46](#) shows the auxiliary port pinouts for the RJ-45 connector. Any pin not referenced is not connected.

Table 5 Auxiliary Port Pinouts for the RJ-45 Connector

Auxiliary Port (DTE)		
Pin	Signal	Input/Output
1	RTS	Output
2	DTR	Output
3	TxD	Output
4	GND	-
5	GND	-
6	RxD	Input
7	DSR	Input
8	CTS	Input

Identify a Rollover Cable

To identify a rollover cable, compare the two modular ends of the cable ([Figure 16 on page 47](#)). Hold the cables in your hand, side-by-side, with the tab at the back. The wire connected to the pin on the outside of the left connector (pin 1) must be the same color as the pin on the outside of the right connector (pin 8).

On Cisco cables, pin 1 is white on one connector, and pin 8 is white on the other connector.

Figure 16 Identifying a Rollover Cable

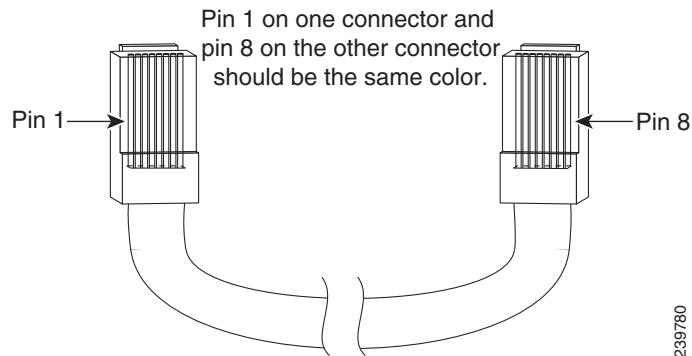

Table 6 on page 47 shows the RJ-45 rolled (console) cable pinouts:

Table 6 RJ-45 Rolled Console Cable Pinouts

Signal	Pin	Pin	Signal
-	1	8	-
-	2	7	-
-	3	6	-
-	4	5	-
-	5	4	-
-	6	3	-
-	7	2	-
-	8	1	-

Console Port Connection to a PC

To connect a PC terminal to the console port, use the RJ-45-to-RJ-45 rollover cable, and either the RJ-45-to-DB-25 female DTE adapter or the RJ-45-to-DB-9 female DTE adapter (labeled *TERMINAL*).

The default parameters for the console port are:

- 9600 baud
- 8 data bits
- No parity generated or checked
- 1 stop bit
- No Flow Control

Console Port Signaling and Cabling with a DB-9 Adapter

This section describes the console port signaling and cabling with a DB-9 adapter. See [Figure 17 on page 48](#) and [Figure 18 on page 48](#)).

Figure 17 RJ-45 Cable to DB-9 Female Adapter

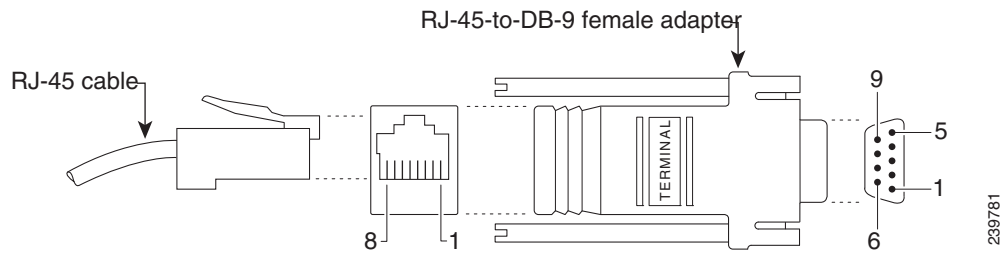

Figure 18 RJ-45 to RJ-45 Rollover Cable

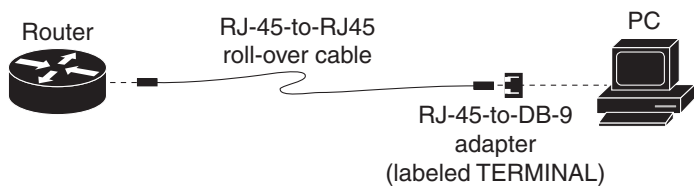

Table 7 on page 48 shows the pinout descriptions for the DB-9 connections:

Table 7 Pinout Descriptions for the DB-9 Connections

Console Port (DTE)	RJ-45 to RJ-45 Rollover Cable		RJ-45 to DB-9 Terminal Adapter	Console Device
Signal	RJ-45 Pin	RJ-45 Pin	DB-9 Pin	Signal
RTS	1 ¹	8	8	CTS
DTR	2	7	6	DSR
TxD	3	6	2	RxD
GND	4	5	5	GND
GND	5	4	5	GND
RxD	6	3	3	TxD
DSR	7	2	4	DTR
CTS	8	1	7	RTS

¹ Pin 1 is connected internally to Pin 8.

Console Port Signaling and Cabling with a DB-25 Adapter

This section describes the console port signaling and cabling with a DB-25 adapter as shown in Figure 19 on page 48 and Figure 20 on page 49.

Figure 19 RJ-45 to DB-25 Adapter (Terminal)

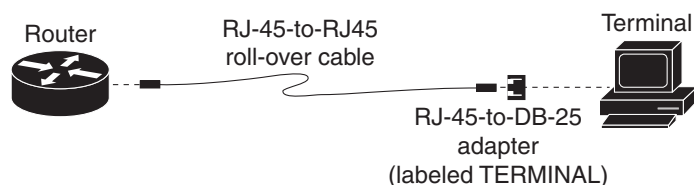

Figure 20 RJ-45 to DB-25 Female Adapter

Table 8 on page 49 shows the pinout descriptions for the DB-25 connections:

Table 8 Pinout Descriptions for the DB-25 Connections

Console Port (DTE) ¹	RJ-45 to RJ-45 Rollover Cable		RJ-45 to DB-25 Terminal Adapter	Console Device
Signal	RJ-45 Pin	RJ-45 Pin	DB-25 Pin	Signal
RTS	1 ²	8	5	CTS
DTR	2	7	6	DSR
TxD	3	6	3	RxD
GND	4	5	7	GND
GND	5	4	7	GND
RxD	6	3	2	TxD
DSR	7	2	20	DTR
CTS	8	1	4	RTS

¹ You can use the same cabling to connect a console to the auxiliary port.

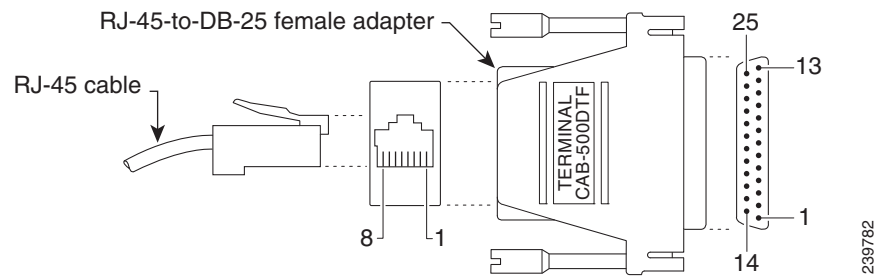
² Pin 1 is connected internally to Pin 8.

Auxiliary Port Connection to a Modem

To connect a PC terminal to the router, use the RJ-45-to-RJ-45 rollover cable and either the RJ-45-to-DB-25 female DTE adapter or the RJ-45-to-DB-9 female DTE adapter (labeled *TERMINAL*).

This section lists the pinout descriptions for both DB-9 and DB-25 connections.

To connect a modem to the auxiliary port, use the RJ-45-to-RJ-45 rollover cable and the RJ-45-to-DB-25 male DCE adapter (labeled *MODEM*).

Auxiliary Port Signaling and Cabling Using a DB-25 Adapter

This section describes the auxiliary port signaling and cabling using a DB-25 adapter as shown in [Figure 21 on page 50](#) and [Figure 22 on page 50](#).

Figure 21 RJ-45 to DB-25 Adapter (Terminal)

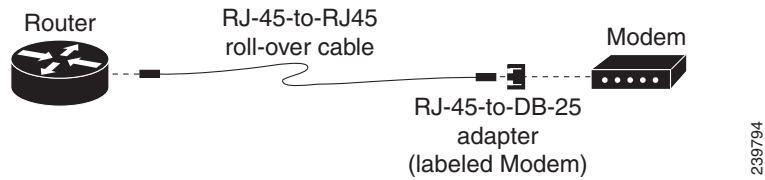

Figure 22 RJ-45 to DB-25 Male Adapter

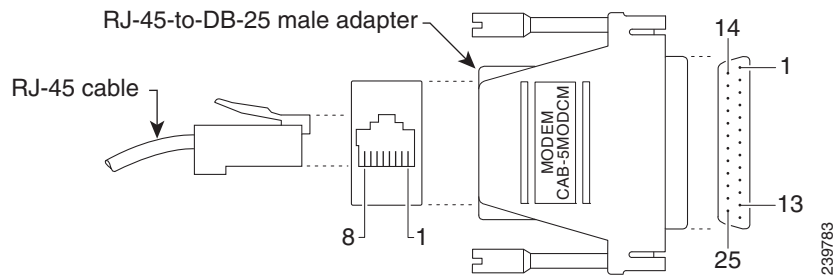

Table 9 on page 50 provides the pinout description for the modem connection:

Table 9 Pinout Descriptions for the Modem Connection

Auxiliary Port (DTE)	RJ-45 to RJ-45 Rollover Cable		RJ-45 to DB-25 Modem Adapter	Modem
Signal	RJ-45 Pin	RJ-45 Pin	DB-25 Pin	Signal
RTS	1 ¹	8	5	CTS
DTR	2	7	6	DSR
TxD	3	6	3	RxD
GND	4	5	7	GND
GND	5	4	7	GND
RxD	6	3	2	TxD
DSR	7	2	20	DTR
CTS	8	1	4	RTS

¹ Pin 1 is connected internally to Pin 8.

Alternative Terminal and Modem Connections

Table 10 on page 51 describes the alternative terminal and modem connections:

Table 10 Alternative Terminal and Modem Connections

Console Port Connection	RJ-45 Cable Type	Adapter
Console port to PC	Straight-through	DCE, DB-9 female
Console port to terminal	Straight-through	DCE, DB-25 female
Auxiliary port to modem	Rollover ¹	DCE, ² DB-25, male
-	Straight-through	DTE, DB-25, male

¹ An octal cable or RJ-45 breakout cable is equivalent to a rollover cable.

² Modify the DB-25 adapter by removing Pin 6 and placing it into the Pin 8 position.

Connectors and Cabling for the 8-Port Asynchronous/ Synchronous RS-232 GRWIC

The 8-Port Asynchronous/Synchronous Grid Router WAN Interface Card (GRWIC) provides low speed synchronous/asynchronous serial connections supporting EIA-RS232 for the Cisco CGR 2010 router. See [Figure 23 on page 51](#)

The 8-port serial RS-232 GRWIC enables applications such as legacy protocol transport, console server, and dial access server. Combining a high-density serial GRWIC with the Cisco CGR 2010 router enables utilities to transport Supervisory Control and Data Acquisition (SCADA) over an IP network.

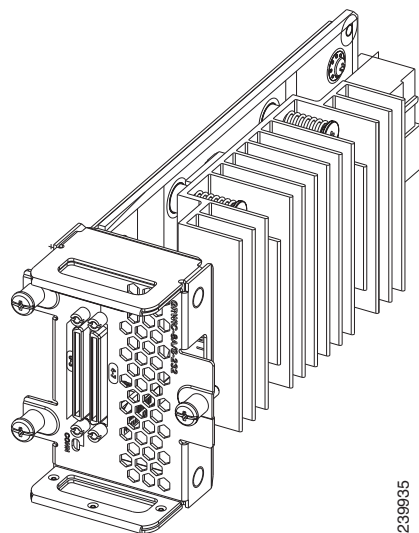
Figure 23 Cisco 8-Port Serial Async/Sync RS-232 GRWIC

The 8-port serial GRWIC has connectors and cabling that allow high-port densities in the compact GRWIC form factor.

The 8-Port Asynchronous/Synchronous GRWIC uses two high-density 4-port connectors. Each connector supports four ports of EIA-232 with data communications equipment (DCE) or data terminal equipment (DTE) interfaces. All four ports on one cable use the same DTE/DCE mode. [Table 11 on page 52](#) outlines the cable specifications for the 8-Port Async/Sync RS-232 GRWIC.

Note: The operating temperature range for these cables is -40° C to +60° C.

Table 11 High-Density Synchronous/Asynchronous Cabling for the 8-Port Async/Sync RS-232 GRWIC

Product Number/ Part Number	Cable Type	Length	Connector Type
CAB-HD4-232FC PN: 74-4025-01	4-port EIA-232 DCE	10 ft. (3m)	Female DB-25
CAB-HD4-232MT PN: 74-4024-01	4-port EIA-232 DTE	10 ft. (3m)	Male DB-25
CAB-QUAD-ASYNC-F PN: 37-1298-01	4-port EIA-232 DTE	18 in. (0.46m)	Female RJ-45
CAB-QUAD-ASYNC-M PN: 37-1303-01	4-port EIA-232 DTE	10 ft. (3m)	Male RJ-45
CAB-9AS-M PN: 37-1300-01	4-port EIA-232 DTE	10 ft. (3m)	Male DB-9

Pinouts for the Synchronous/Asynchronous Cables

This section provides the pinouts for the five serial cables for the 8-Port Async/Sync RS-232 GRWIC.

RS-232 DB-25 Cable Pinouts

The RS-232 DB-25 connector is capable of supporting two separate connections, each with its own optional clock when used in Synchronous mode or Bit-Synchronous mode. [Table 12 on page 53](#) shows the pinouts for the CAB-HD4-232FC and CAB-HD4-232MT serial cables.

Note: In the Direction column, *Input* means data input to the CGR 2010 router; *Output* means output from the CGR 2010 router.

Table 12 Pinouts for Male and Female DB-25 Cables

Pin	Signal	Direction	Description
1	SHIELD GND	–	Shield Ground
2	TXD	Input	Transmit Data. Arriving data from DCE.
3	RXD	Output	Transmit Data. Sending data from DTE.
4	RTS	Input	Request to Send
5	CTS	Output	Clear to Send
6	DSR	Output	Data Set Ready
7	GND	–	Ground
8	DCD	Output	Carrier Detect
9	–	–	Reserved for data set testing.
10	–	–	Reserved for data set testing.
11	–	–	Unassigned
12	–	–	Unassigned
13	–	–	Unassigned
14	–	–	Unassigned
15	TXC	Output	Transmit Clock
16	–	–	Unassigned
17	RXC	Output	Receive Clock
18	LTST	Input	Loopback Test (also Local Loopback)
19	–	–	Unassigned
20	DTR	Input	Data Terminal Ready
21	–	–	Unassigned
22	–	–	Unassigned
23	–	–	Unassigned
24	TXCE	Input	Transmit Clock Enable
25	–	–	Unassigned

RS-232 DB-9 Cable Pinouts

[Table 13 on page 53](#) shows the pinouts for the CAB-9AS-M (High Density 4-port EIA-232 to DB-9, DTE) cable.

Table 13 Pinouts for CAB-9AS-M (Male DB-9)

Pin	Signal	Direction	Description
1	–	–	
2	RD	Input	Receive Data. Arriving data from DCE.
3	TD	Output	Transmit Data. Sending data from DTE.
4	–	–	
5	SGND	–	Ground
6	–	–	

Table 13 Pinouts for CAB-9AS-M (Male DB-9) (continued)

Pin	Signal	Direction	Description
7	RTS	Output	Request to Send. Raised by DCE when it wishes to send. Expects CTS from DTE.
8	CTS	Input	Clear to Send. Raised by DCE in response to RTS from DTE.
9	–	–	

RS-232 RJ-45 Cable Pinouts

[Table 14 on page 54](#) shows the pinouts for the CAB-QUAD-ASYNC-M (High Density 4-port EIA-232 to Male RJ45, DTE) and CAB-QUAD-ASYNC-F RJ-45 (High Density 4-port EIA-232 to Female RJ45, 18 inches, DTE) cables:

Table 14 Pinouts for the Male and Female RJ-45 Cables

Pin	Signal	Description
1	RTS	Request to Send
2	–	Unassigned
3	TXD	Transmit Data
4	SGND	Signal Ground
5	GRND	Ground
6	RXD	Transmit Data
7	–	Unassigned
8	CTS	Clear to Send



Configuring the Router

This section describes how to power up the router and perform the initial configuration.

These topics are discussed:

- [Powering up the Router, page 55](#)
- [Performing the Initial Configuration on the Router, page 57](#)
- [Verifying the Initial Configuration, page 76](#)

Powering up the Router

Warning: Blank faceplates and cover panels serve three important functions: they prevent exposure to hazardous voltages and currents inside the chassis; they contain electromagnetic interference (EMI) that might disrupt other equipment; and they direct the flow of cooling air through the chassis. Do not operate the system unless all cards, faceplates, front covers, and rear covers are in place. Statement 1029

These topics are discussed:

- [Powering up the Router, page 55](#)
- [Performing the Initial Configuration on the Router, page 57](#)
- [Verifying Network Connectivity, page 72](#)
- [Verifying the Initial Configuration, page 76](#)

Checklist for Power Up

Check the following items before powering up the router:

- Chassis is securely mounted and grounded.
- Interface cables are connected.
- Compact flash memory card is properly seated into its slot. For installation instructions, see [Removing and Installing Compact Flash Memory Cards, page 77](#).
- PC with terminal emulation program (HyperTerminal or equivalent) is connected to the console port and configured for 9600 baud, 8 data bits, 1 stop bit, no parity, and flow control is set to “none.”
- Suitable PC COM port is selected in the terminal emulation program.
- Passwords for access control are selected.
- IP addresses for the Ethernet and serial interfaces have been determined.

Power Up Procedure

This procedure powers up the router and verifies that it has performed the initialization and self-test. When the procedure completes, the router is ready to configure. If you encounter problems while powering on the router, see the Troubleshooting page for the router on www.cisco.com.

For information about the ROM monitor and the bootstrap program, see [Using the ROM Monitor](#) in the software configuration guide for the router. For information about the configuration register, see [Changing the Configuration Register Settings](#) in the software configuration guide for the router.

Note: To view the boot sequence, you must establish console connection to the Cisco router *before* it powers up.

To power up your Cisco router:

1. Ensure that your PC is powered up and connected as described in [Checklist for Power Up, page 55](#).
2. Make connectivity to the power blocks.
 - SYS LED on the front of the chassis begins blinking green.
 - Startup messages appear in your Console window. When the startup messages finish, the SYS LED appears solid green.

Caution: Do not press any keys on the keyboard until the messages stop and the SYS LED is solid green. Any keys pressed during this time are interpreted as the first command typed when the messages stop, which might cause the router to power off and start over. It takes a few minutes for the messages to stop.

If you encounter a problem during the power up process, see [Troubleshooting](#) on the www.cisco.com product page.

3. Use any of the following tools to perform the initial configuration.
 - [Cisco Configuration Professional Express, page 57](#)

Note: We recommend using Cisco Configuration Professional Express to perform the initial configuration on the router because it provides a web-based graphical-user interface. See [Cisco Configuration Professional Express, page 57](#).

- [Cisco Setup Command Facility, page 56](#)
- [Cisco Command Line Interface, page 57](#)

Cisco Setup Command Facility

Cisco Setup Command Facility lets you configure the initial router settings through a configuration dialog. If you see the following messages, the router has booted and is ready for initial configuration using the setup command facility.

```
--- System Configuration Dialog ---
```

```
At any point you may enter a question mark '?' for help.  
Use ctrl-c to abort configuration dialog at any prompt.  
Default settings are in square brackets '['].
```

```
Would you like to enter the initial configuration dialog? [yes/no]:
```

See [Performing the Initial Configuration on the Router, page 57](#) for additional information.

Note: If the system configuration dialog message does not appear, a default configuration file was installed on the router prior to shipping. See [Using Cisco Configuration Professional Express, page 60](#) to configure the router.

Cisco Configuration Professional Express

Use the Cisco Configuration Professional Express web-based application to configure the initial router settings. See [Cisco Configuration Professional Express User Guide](#) on www.cisco.com for detailed instructions.

Cisco Command Line Interface

Cisco Command Line Interface (CLI) lets you configure the initial router settings manually. If you see the following messages, the router has booted and is ready for initial configuration using the CLI. For how to use the CLI to configure the router, see [Using Cisco IOS CLI—Manual Configuration, page 60](#).

Note: If the `rommon 1>` prompt appears, your system has booted in ROM monitor mode. For information on the ROM monitor, see [Using the ROM Monitor](#) in the software configuration guide for the router.

Verifying the Power Supply Side LED Indications

The front-panel indicator LEDs described in [Table 5 on page 13](#) provide power, activity, and status information useful during power up.

Performing the Initial Configuration on the Router

Use the following tools to perform the initial configuration on the router:

- [Using the Cisco Setup Command Facility, page 57](#)
- [Using Cisco Configuration Professional Express, page 60](#)
- [Using Cisco IOS CLI—Manual Configuration, page 60](#)

Using the Cisco Setup Command Facility

The setup command facility prompts you to enter the information that is needed to configure a router quickly. The facility guides you through a initial configuration, including LAN and WAN interfaces. For more general information about the setup command facility, see the following document:

Cisco IOS Configuration Fundamentals Configuration Guide, Release 12.4, Part 2: Cisco IOS User Interfaces: Using AutoInstall and Setup:

http://www.cisco.com/en/US/docs/ios/fundamentals/configuration/guide/12_4/cf_12_4_book.html

This section explains how to configure a hostname for the router, set passwords, and configure an interface for communication with the management network.

Note: The following example and the user entries (in **bold**) are shown as examples only.

Note: If you make a mistake while using the setup command facility, you can exit and run the setup command facility again. Press **Ctrl-C**, and enter the **setup** command in privileged EXEC mode (`Router#`).

1. Enter the setup command facility by using one of the following methods:

- From the Cisco IOS CLI, enter the **setup** command in privileged EXEC mode:

```
Router> enable  
Password: <password>  
Router# setup
```

```
--- System Configuration Dialog ---
```

Performing the Initial Configuration on the Router

```
Continue with configuration dialog? [yes/no]:
```

You are now in the Setup Configuration Utility.

The following steps and the user entries (in bold) are shown as examples only.

Note: If you make a mistake while using the setup command facility, you can exit and run the setup command facility again. Press **Ctrl-C**, and enter the setup command at the privileged EXEC mode prompt (Router#). For more information on using the setup command facility, see The Setup Command chapter in *Cisco IOS Configuration Fundamentals Command Reference*, Release 12.2T:

http://www.cisco.com/en/US/docs/ios/12_2t/fun/command/reference/122tfr.html

2. To proceed using the setup command facility, enter **yes**.

```
Continue with configuration dialog? [yes/no]:
```

At any point you may enter a question mark '?' for help.

Use ctrl-c to abort configuration dialog at any prompt.
Default settings are in square brackets '['].

Basic management setup configures only enough connectivity.

```
Would you like to enter basic management setup? [yes/no]: yes
```

3. Enter a hostname for the router (this example uses myrouter):

```
Configuring global parameters:  
Enter host name [Router]: my router
```

4. Enter an enable secret password. This password is encrypted (for more security) and cannot be seen when viewing the configuration.

The enable secret is a password used to protect access to privileged EXEC and configuration modes. This password, after entered, becomes encrypted in the configuration.

```
Enter enable secret: password1
```

5. Enter an enable password that is different from the enable secret password. This password is *not* encrypted (and is less secure) and can be seen when viewing the configuration.

The enable password is used when you do not specify an enable secret password, with some older software versions, and some boot images.

```
Enter enable password: password2
```

6. Enter the virtual terminal password, which prevents unauthenticated access to the router through ports other than the console port:

The virtual terminal password is used to protect access to the router over a network interface.

```
Enter virtual terminal password: password3
```

7. Respond to the following prompts as appropriate for your network:

```
Configure SNMP Network Management? [no]: yes  
Community string [public]:
```

A summary of the available interfaces is displayed.

Note: The interface summary includes interface numbering, which is dependent on the router model and the installed modules and interface cards.

Performing the Initial Configuration on the Router

Current interface summary

Interface	IP-Address	OK?	Method	Status	Protocol
GigabitEthernet0/0	unassigned	YES	NVRAM	administratively down	down
GigabitEthernet0/1	10.10.10.12	YES	DHCP	up	up
SSLVPN-VIF0	unassigned	NO	unset	up	

Any interface listed with OK? value "NO" does not have a valid configuration

8. Select one of the available interfaces for connecting the router to the management network:

Enter interface name used to connect to the management network from the above interface summary: **gigabitethernet0/1**

9. Respond to the following prompts as appropriate for your network:

```
Configuring interface GigabitEthernet0/1:
Configure IP on this interface? [yes]: yes
IP address for this interface [10.10.10.12]:
Subnet mask for this interface [255.0.0.0] : 255.255.255.0
Class A network is 10.0.0.0, 24 subnet bits; mask is /24
```

The following configuration command script is created:

```
hostname myrouter
enable secret 5 $1$t/Dj$yAeGKviLLZNOBX0b9eif00 enable password cisco123 line vty 0 4 password cisco
snmp-server community public !
no ip routing

!
interface GigabitEthernet0/0
shutdown
no ip address
!
interface GigabitEthernet0/1
no shutdown
ip address 10.10.10.12 255.255.255.0
!
end
```

10. Respond to the following prompts. Select [2] to save the initial configuration:

```
[0] Go to the IOS command prompt without saving this config.
[1] Return back to the setup without saving this config.
[2] Save this configuration to nvram and exit.

Enter your selection [2]: 2
Building configuration...
Use the enabled mode 'configure' command to modify this configuration.

Press RETURN to get started! RETURN
```

The user prompt appears:

```
myrouter>
```

When using the Cisco Setup, and after you have provided all the information requested by the facility, the final configuration appears. The facility prompts you to save the configuration.

- If you answer **no**, the configuration information you entered is *not* saved, and you return to the router enable prompt (Router#). Enter **setup** to return to the System Configuration Dialog.

Performing the Initial Configuration on the Router

- If you answer **yes**, the configuration is saved, and you are returned to the user EXEC prompt (`Router>`).

```
Use this configuration? {yes/no} : yes
Building configuration...
Use the enabled mode 'configure' command to modify this configuration.
```

Press RETURN to get started!

```
%LINK-3-UPDOWN: Interface Ethernet0/0, changed state to up
%LINK-3-UPDOWN: Interface Ethernet0/1, changed state to up
%LINK-3-UPDOWN: Interface Serial1/0, changed state to up
```

<Additional messages omitted.>

To complete router configuration:

11. When the messages stop appearing on your screen, press **Return** to get the `Router>` prompt.

Note: If you see the next message, it means that no other routers were found on the network attached to the port.

```
%AT-6-ONLYROUTER: Ethernet0/0: AppleTalk port enabled; no neighbors found
```

12. The `Router>` prompt indicates that you are now at the command-line interface (CLI) and you have just completed a initial router configuration. Nevertheless, this is *not* a complete configuration. At this point, you have two choices:

Run the setup command facility again, and create another configuration:

```
Router> enable
Password: password
Router# setup
```

Modify the existing configuration or configure additional features by using the CLI:

```
Router> enable
Password: password
Router# configure terminal
Router(config)#
```

Using Cisco Configuration Professional Express

Use Cisco Configuration Professional Express web-based application to configure the initial router settings. See [Cisco Configuration Professional Express User Guide](#) on www.cisco.com for detailed instructions.

For help with interface and port numbering, see [Slot, Port, and Interface Information, page 11](#).

Using Cisco IOS CLI—Manual Configuration

This section shows you how to access the command-line interface (CLI) to perform the initial configuration on the router.

If the system configuration dialog message does not appear, a default configuration file was installed on the router prior to shipping. See [Using Cisco Configuration Professional Express, page 60](#) to configure the router.

For help with interface and port numbering, see [Slot, Port, and Interface Information, page 11](#).

To access the command-line interface (CLI) and perform the initial configuration on the router:

1. Enter the following answer when the system message appears on the router.

```
--- System Configuration Dialog ---
```

At any point you may enter a question mark '?' for help.

Performing the Initial Configuration on the Router

Use `ctrl-c` to abort configuration dialog at any prompt.
Default settings are in square brackets '[]'.

Would you like to enter the initial configuration dialog? [yes/no]: **no**

2. Press `Return` to terminate autoinstall and continue with manual configuration:

Would you like to terminate autoinstall? [**yes**] **Return**

Several messages appear, ending with a line similar to the following:

```
...
Copyright (c) 1986-2009 by cisco Systems, Inc.
Compiled <date> <time> by <person>
```

3. Press `Return` to bring up the `Router>` prompt.

```
...
flashfs[4]: Initialization complete.
Router>
```

4. Type `enable` to enter privileged EXEC mode:

```
Router> enable
Router#
```

The following tasks are either required or optional:

- [Configuring the Router Hostname, page 61](#) (Optional)
- [Configuring the Enable and Enable Secret Passwords, page 62](#) (Required)
- [Configuring the Console Idle Privileged EXEC Timeout, page 64](#) (Optional)
- [Configuring Gigabit and FastEthernet Interfaces, page 65](#) (Required)
- [Specifying a Default Route or Gateway of Last Resort, page 67](#) (Required)
- [Configuring IP Routing and IP Protocols, page 67](#) (Required)
- [Default Routes, page 67](#) (Optional)
- [Default Network, page 68](#) (Optional)
- [Configuring Virtual Terminal Lines for Remote Console Access, page 70](#) (Required)
- [Configuring the Auxiliary Line, page 72](#) (Optional)

Configuring the Router Hostname

The hostname is used in CLI prompts and default configuration filenames. If you do not configure the router hostname, the router uses the factory-assigned default hostname “Router.”

Do not expect capitalization and lower casing to be preserved in the hostname. Uppercase and lowercase characters are treated as identical by many Internet software applications. It may seem appropriate to capitalize a name as you would ordinarily do, but conventions dictate that computer names appear in all lowercase characters. For more information, see the RFC 1178, *Choosing a Name for Your Computer*.

The name must also follow the rules for Advanced Research Projects Agency Network (ARPANET) hostnames. They must start with a letter, end with a letter or digit, and have as interior characters only letters, digits, and hyphens. Names must be 63 characters or fewer. For more information, see the RFC 1035, *Domain Names—Implementation and Specification*.

This is a summary of the steps required to assign a router hostname:

1. **enable**
2. **configure terminal**
3. **hostname** *name*
4. Verify that the router prompt displays your new hostname.
5. **end**

Table 1 Detailed Steps

	Command or Action	Purpose
Step 1	enable Example: Router> enable	Enables privileged EXEC mode. ■ Enter your password if prompted.
Step 2	configure terminal Example: Router# configure terminal	Enters global configuration mode.
Step 3	hostname <i>name</i> Example: Router(config)# hostname myrouter	Specifies or modifies the hostname for the network server.
Step 4	Verify that the router prompt displays your new hostname. Example: myrouter(config)#	—
Step 5	end Example: myrouter# end	(Optional) Returns to privileged EXEC mode.

Configuring the Enable and Enable Secret Passwords

To provide an additional layer of security, particularly for passwords that cross the network or are stored on a TFTP server, use either the **enable password** command or the **enable secret** command. Both commands accomplish the same thing—they allow you to establish an encrypted password that users must enter to access privileged EXEC (enable) mode.

We recommend that you use the **enable secret** command because it uses an improved encryption algorithm. Use the **enable password** command only if you boot an older version of the Cisco IOS software or if you boot older boot ROMs that do not recognize the **enable secret** command.

For more information, see the “Configuring Passwords and Privileges” chapter in *Cisco IOS Security Configuration Guide*. Also see [Cisco IOS Password Encryption Facts](#) and [Improving Security on Cisco Routers](#).

Restrictions

If you configure the **enable secret** command, it takes precedence over the **enable password** command; the two commands cannot be in effect simultaneously.

This is a summary of the steps required to enable configure the **enable secret** command:

1. **enable**
2. **configure terminal**
3. **enable password** *password*
4. **enable secret** *password*
5. **end**
6. **enable**
7. **end**

Table 2 Detailed Steps

	Command or Action	Purpose
Step 1	enable Example: Router> enable	Enables privileged EXEC mode. ■ Enter your password if prompted.
Step 2	configure terminal Example: Router# configure terminal	Enters global configuration mode.
Step 3	enable password <i>password</i> Example: Router(config)# enable password pswd2	(Optional) Sets a local password to control access to various privilege levels. ■ We recommend that you perform this step only if you boot an older image of the Cisco IOS software or if you boot older boot ROMs that do not recognize the enable secret command.
Step 4	enable secret <i>password</i> Example: Router(config)# enable secret greentree	Specifies an additional layer of security over the enable password command. ■ Do not use the same password that you entered in Step 3 .
Step 5	end Example: Router(config)# end	Returns to privileged EXEC mode.
Step 6	enable Example: Router> enable	Enables privileged EXEC mode. ■ Verify that your new enable or enable secret password works.
Step 7	end Example: Router(config)# end	(Optional) Returns to privileged EXEC mode.

Configuring the Console Idle Privileged EXEC Timeout

This section describes how to configure the console line idle privileged EXEC timeout. By default, the privileged EXEC command interpreter waits 10 minutes to detect user input before timing out.

When you configure the console line, you can also set communication parameters, specify autobaud connections, and configure terminal operating parameters for the terminal that you are using. For more information on configuring the console line, see the *Cisco IOS Configuration Fundamentals and Network Management Configuration Guide*. In particular, see the “Configuring Operating Characteristics for Terminals” and “Troubleshooting and Fault Management” chapters.

This is a summary of the steps required to configure the console line idle privileged EXEC timeout:

1. **enable**
2. **configure terminal**
3. **line console 0**
4. **exec-timeout** *minutes* [*seconds*]
5. **end**
6. **show running-config**

Table 3 Detailed Steps

	Command or Action	Purpose
Step 1	enable Example: Router> enable	Enables privileged EXEC mode. ■ Enter your password if prompted.
Step 2	configure terminal Example: Router# configure terminal	Enters global configuration mode.
Step 3	line console 0 Example: Router(config)# line console 0	Configures the console line and starts the line configuration command collection mode.

Table 3 Detailed Steps

	Command or Action	Purpose
Step 4	exec-timeout <i>minutes</i> [<i>seconds</i>] Example: Router(config-line)# exec-timeout 0 0	Sets the idle privileged EXEC timeout, which is the interval that the privileged EXEC command interpreter waits until user input is detected. <ul style="list-style-type: none"> ■ The example shows how to specify no timeout. Setting the exec-timeout value to 0 will cause the router to never log out once logged in. This could have security implications if you leave the console without manually logging out using the disable command.
Step 5	end Example: Router(config)# end	Returns to privileged EXEC mode.
Step 6	show running-config Example: Router(config)# show running-config	Displays the running configuration file. <ul style="list-style-type: none"> ■ Verify that you properly configured the idle privileged EXEC timeout.

EXAMPLES

The following example shows how to set the console idle privileged EXEC timeout to 2 minutes 30 seconds:

```
line console
exec-timeout 2 30
```

The following example shows how to set the console idle privileged EXEC timeout to 10 seconds:

```
line console
exec-timeout 0 10
```

Configuring Gigabit and FastEthernet Interfaces

This section shows how to assign an IP address and interface description to a Gigabit interface and an Ethernet interface on your router.

For comprehensive configuration information on Gigabit Ethernet interfaces, see chapter “Configuring LAN Interfaces” in [Cisco IOS Interface and Hardware Component Configuration Guide](#).

For information on interface numbering, see the software configuration guide for your router.

This is a summary of the steps required to assign an IP address and interface description to a Gigabit interface and an Ethernet interface on your router:

1. **enable**
2. **show ip interface brief**
3. **configure terminal**
4. **interface** {fastethernet | gigabitethernet} *0/port*
5. **description** *string*
6. **ip address** *ip-address mask*

7. **no shutdown**

8. **end**

9. **show ip interface brief**

Table 4 Detailed Steps

	Command or Action	Purpose
Step 1	<p>enable</p> <p>Example: Router> enable</p>	<p>Enables privileged EXEC mode.</p> <ul style="list-style-type: none"> ■ Enter your password if prompted.
Step 2	<p>show ip interface brief</p> <p>Example: Router# show ip interface brief</p>	<p>Displays a brief status of the interfaces that are configured for IP.</p> <ul style="list-style-type: none"> ■ Determine which type of Ethernet interface is on your router.
Step 3	<p>configure terminal</p> <p>Example: Router# configure terminal</p>	<p>Enters global configuration mode.</p>
Step 4	<p>interface {fastethernet gigabitethernet} 0/port</p> <p>Example: Router(config)# interface gigabitethernet 0/0</p>	<p>Specifies the Ethernet interface and enters interface configuration mode.</p> <p>Note For information on interface numbering, see the software configuration guide.</p>
Step 5	<p>description string</p> <p>Example: Router(config-if)# description GE int to 2nd floor south wing</p>	<p>(Optional) Adds a description to an interface configuration.</p> <ul style="list-style-type: none"> ■ The description helps you remember what is attached to this interface. The description can be useful for troubleshooting.
Step 6	<p>ip address ip-address mask</p> <p>Example: Router(config-if)# ip address 172.16.74.3 255.255.255.0</p>	<p>Sets a primary IP address for an interface.</p>
Step 7	<p>no shutdown</p> <p>Example: Router(config-if)# no shutdown</p>	<p>Enables an interface.</p>
Step 8	<p>end</p> <p>Example: Router(config)# end</p>	<p>Returns to privileged EXEC mode.</p>
Step 9	<p>show ip interface brief</p> <p>Example: Router# show ip interface brief</p>	<p>Displays a brief status of the interfaces that are configured for IP.</p> <ul style="list-style-type: none"> ■ Verify that the Ethernet interfaces are up and configured correctly.

EXAMPLES

Configuring the GigabitEthernet Interface:

```
!
interface GigabitEthernet0/0
  description GE int to HR group
  ip address 172.16.3.3 255.255.255.0
  duplex auto
  speed auto
  no shutdown
!
```

Sample output for the show ip interface brief command:

```
Router# show ip interface brief
```

Interface	IP-Address	OK?	Method	Status	Protocol
GigabitEthernet0/0	172.16.3.3	YES	NVRAM	up	up
GigabitEthernet0/1	unassigned	YES	NVRAM	administratively down	down

```
Router#
```

Specifying a Default Route or Gateway of Last Resort

This section describes how to specify a default route with IP routing enabled. For alternative methods of specifying a default route, see [Configuring a Gateway of Last Resort Using IP Commands](#).

The Cisco IOS software uses the gateway (router) of last resort if it does not have a better route for a packet and if the destination is not a connected network. This section describes how to select a network as a default route (a candidate route for computing the gateway of last resort). The way in which routing protocols propagate the default route information varies for each protocol.

Configuring IP Routing and IP Protocols

For comprehensive configuration information about IP routing and IP routing protocols, see [Cisco IOS IP Routing Protocols Configuration Guide, Release 12.4T](#) on www.cisco.com.

IP Routing

You can configure integrated routing and bridging (IRB) so the router can route and bridge simultaneously. The router acts as an IP host on the network whether routing is enabled or not.

To read more about IRB, see the following URL:

http://www.cisco.com/en/US/tech/tk389/tk815/tk855/tsd_technology_support_sub-protocol_home.html

IP routing is automatically enabled in the Cisco IOS software. When IP routing is configured, the system uses a configured or learned route to forward packets, including a configured default route.

Note: This task section does not apply when IP routing is disabled. To specify a default route when IP routing is disabled, see [Configuring a Gateway of Last Resort Using IP Commands](#) on www.cisco.com.

Default Routes

A router might not be able to determine the routes to all other networks. To provide complete routing capability, the common practice is to use some routers as smart routers and give the remaining routers default routes to the smart router. (Smart routers have routing table information for the entire internetwork.) These default routes can be passed along dynamically, or can be configured into the individual routers.

Most dynamic interior routing protocols include a mechanism for causing a smart router to generate dynamic default information that is then passed along to other routers.

Default Network

If a router has an interface that is directly connected to the specified default network, the dynamic routing protocols running on the router generates or sources a default route. In the case of RIP, the router advertises the pseudonetwork 0.0.0.0. In the case of IGRP, the network itself is advertised and flagged as an exterior route.

A router that is generating the default for a network also may need a default of its own. One way a router can generate its own default is to specify a static route to the network 0.0.0.0 through the appropriate device.

Gateway of Last Resort

When default information is being passed along through a dynamic routing protocol, no further configuration is required. The system periodically scans its routing table to choose the optimal default network as its default route. In the case of RIP, there is only one choice, network 0.0.0.0. In the case of IGRP, there might be several networks that can be candidates for the system default. The Cisco IOS software uses both administrative distance and metric information to determine the default route (gateway of last resort). The selected default route appears in the gateway of last resort display of the **show ip route EXEC** command.

If dynamic default information is not being passed to the software, candidates for the default route are specified with the **ip default-network** global configuration command. In this usage, the **ip default-network** command takes an unconnected network as an argument. If this network appears in the routing table from any source (dynamic or static), it is flagged as a candidate default route and is a possible choice as the default route.

If the router has no interface on the default network, but does have a route to it, it considers this network as a candidate default path. The route candidates are examined and the best one is chosen, based on administrative distance and metric. The gateway to the best default path becomes the gateway of last resort.

This is a summary of the steps required to specify a default route with IP routing enabled

1. **enable**
2. **configure terminal**
3. **ip routing**
4. **ip route** *dest-prefix mask next-hop-ip-address* [*admin-distance*] [**permanent**]
5. **ip default-network** *network-number*
or
ip route *dest-prefix mask next-hop-ip-address*
6. **end**
7. **show ip route**

Table 5 Detailed Steps

	Command or Action	Purpose
Step 1	<p>enable</p> <p>Example: Router> enable</p>	<p>Enables privileged EXEC mode.</p> <ul style="list-style-type: none"> ■ Enter your password if prompted.
Step 2	<p>configure terminal</p> <p>Example: Router# configure terminal</p>	<p>Enters global configuration mode.</p>
Step 3	<p>ip routing</p> <p>Example: Router(config)# ip routing</p>	<p>Enables IP routing.</p>
Step 4	<p>ip route dest-prefix mask next-hop-ip-address [admin-distance] [permanent]</p> <p>Example: Router(config)# ip route 192.168.24.0 255.255.255.0 172.28.99.2</p>	<p>Establishes a static route.</p>
Step 5	<p>ip default-network network-number</p> <p>or</p> <p>ip route dest-prefix mask next-hop-ip-address</p> <p>Example: Router(config)# ip default-network 192.168.24.0</p> <p>Example: Router(config)# ip route 0.0.0.0 0.0.0.0 172.28.99.1</p>	<p>Selects a network as a candidate route for computing the gateway of last resort.</p> <p>Creates a static route to network 0.0.0.0 0.0.0.0 for computing the gateway of last resort.</p>
Step 6	<p>end</p> <p>Example: Router(config)# end</p>	<p>Returns to privileged EXEC mode.</p>
Step 7	<p>show ip route</p> <p>Example: Router# show ip route</p>	<p>Displays the current routing table information.</p> <ul style="list-style-type: none"> ■ Verify that the gateway of last resort is set.

EXAMPLES

Specifying a default route:

```
!
ip routing
```

Performing the Initial Configuration on the Router

```
!  
ip route 192.168.24.0 255.255.255.0 172.28.99.2  
!  
ip default-network 192.168.24.0  
!
```

Sample output for the show ip route command:

```
Router# show ip route  
  
Codes: C - connected, S - static, I - IGRP, R - RIP, M - mobile, B - BGP  
        D - EIGRP, EX - EIGRP external, O - OSPF, IA - OSPF inter area  
        E1 - OSPF external type 1, E2 - OSPF external type 2, E - EGP  
        I - IS-IS, L1 - IS-IS level-1, L2 - IS-IS level-2, * - candidate default  
Gateway of last resort is 172.28.99.2 to network 192.168.24.0  
  
    172.24.0.0 255.255.255.0 is subnetted, 1 subnets  
C       172.24.192.0 is directly connected, FastEthernet0  
S       172.24.0.0 255.255.0.0 [1/0] via 172.28.99.0  
S*     192.168.24.0 [1/0] via 172.28.99.2  
    172.16.0.0 255.255.255.0 is subnetted, 1 subnets  
C       172.16.99.0 is directly connected, FastEthernet1  
Router#
```

Configuring Virtual Terminal Lines for Remote Console Access

Virtual terminal (vty) lines are used to allow remote access to the router. This section shows you how to configure the virtual terminal lines with a password, so that only authorized users can remotely access the router.

The router has five virtual terminal lines by default. However, you can create additional virtual terminal lines as described in *Cisco IOS Terminal Services Configuration Guide, Release 12.4*. See http://www.cisco.com/en/US/docs/ios/termserv/configuration/guide/tsv_term_op_char_dialin_ps6350_TSD_Products_Configuration_Guide_Chapter.html.

Line passwords and password encryption is described in the *Cisco IOS Security Configuration Guide, Release 12.4*. See http://www.cisco.com/en/US/docs/ios/security/configuration/guide/12_4/sec_12_4_book.pdf.

Note: To secure the vty lines with an access list, see <http://www.cisco.com/en/US/products/index.html>

and

http://www.cisco.com/en/US/tech/tk59/technologies_tech_note09186a00809d38a7.shtml.

These are the required summary steps to allow remote access to the router:

1. **enable**
2. **configure terminal**
3. **line vty** *line-number* [*ending-line-number*]
4. **password** *password*
5. **login**
6. **end**
7. **show running-config**
8. From another network device, attempt to open a Telnet session to the router.

Table 6 Detailed Steps

	Command or Action	Purpose
Step 1	<p>enable</p> <p>Example: Router> enable</p>	<p>Enables privileged EXEC mode.</p> <ul style="list-style-type: none"> ■ Enter your password if prompted.
Step 2	<p>configure terminal</p> <p>Example: Router# configure terminal</p>	<p>Enters global configuration mode.</p>
Step 3	<p>line vty <i>line-number</i> [<i>ending-line-number</i>]</p> <p>Example: Router(config)# line vty 0 4</p>	<p>Starts the line configuration command collection mode for the virtual terminal lines (vty) for remote console access.</p> <ul style="list-style-type: none"> ■ Ensure that you configure all vty lines on your router. <p>Note: To verify the number of vty lines on your router, use the line vty ? command.</p>
Step 4	<p>password <i>password</i></p> <p>Example: Router(config-line)# password <i>guessagain</i></p>	<p>Specifies a password on a line.</p>
Step 5	<p>login</p> <p>Example: Router(config-line)# login</p>	<p>Enables password checking at login.</p>
Step 6	<p>end</p> <p>Example: Router(config-line)# end</p>	<p>Returns to privileged EXEC mode.</p>
Step 7	<p>show running-config</p> <p>Example: Router# show running-config</p>	<p>Displays the running configuration file.</p> <ul style="list-style-type: none"> ■ Verify that you properly configured the virtual terminal lines for remote access.
Step 8	<p>From another network device, attempt to open a Telnet session to the router.</p> <p>Example: Router# 172.16.74.3 Password:</p>	<p>Verifies that you can remotely access the router and that the virtual terminal line password is correctly configured.</p>

EXAMPLES

The following example shows how to configure virtual terminal lines with a password:

```
!
line vty 0 4
  password anyname
  login
!
```

What to Do Next

After you configure the vty lines, follow these steps:

- (Optional) To encrypt the virtual terminal line password, see the “Configuring Passwords and Privileges” chapter in *Cisco IOS Security Configuration Guide*. Also see the [Cisco IOS Password Encryption Facts](#) tech note.
- (Optional) To secure the VTY lines with an access list, see the “Part 3: Traffic Filtering and Firewalls” chapter in *Cisco IOS Security Configuration Guide*.

Configuring the Auxiliary Line

This section describes how to enter line configuration mode for the auxiliary line. How you configure the auxiliary line depends on your particular implementation of the auxiliary (AUX) port. See [Configuring a Modem on the AUX Port for EXEC Dialin Connectivity](#).

These are the required summary steps to enter line configuration mode for the auxiliary line

1. **enable**
2. **configure terminal**
3. **line aux 0**

Note: See the tech notes and sample configurations to configure the line for your particular implementation of the AUX port.

Table 7 Detailed Steps

	Command or Action	Purpose
Step 1	enable Example: Router> enable	Enables privileged EXEC mode. <ul style="list-style-type: none"> ■ Enter your password if prompted.
Step 2	configure terminal Example: Router# configure terminal	Enters global configuration mode.
Step 3	line aux 0 Example: Router(config)# line aux 0	Starts the line configuration command collection mode for the auxiliary line.
Step 4	See the tech notes and sample configurations to configure the line for your particular implementation of the AUX port.	—

Verifying Network Connectivity

This section describes how to verify network connectivity for your router.

Prerequisites

- Complete all previous configuration tasks in this document.
- The router must be connected to a properly configured network host.

These are the required summary steps to verify network connectivity for your router:

1. **enable**
2. **ping** [*ip-address* | *hostname*]
3. **telnet** {*ip-address* | *hostname*}

Table 8 Detailed Steps

	Command or Action	Purpose
Step 1	enable Example: Router> enable	Enables privileged EXEC mode. ■ Enter your password if prompted.
Step 2	ping [<i>ip-address</i> <i>hostname</i>] Example: Router# ping 172.16.74.5	Diagnoses initial network connectivity. ■ To verify connectivity, ping the next hop router or connected host for each configured interface to.
Step 3	telnet { <i>ip-address</i> <i>hostname</i> }	Logs in to a host that supports Telnet. ■ To test the vty line password, perform this step from a different network device, and use your router's IP address.

EXAMPLES

Sample output for the ping command when you ping the IP address 192.168.7.27:

```
Router# ping

Protocol [ip]:
Target IP address: 192.168.7.27
Repeat count [5]:
Datagram size [100]:
Timeout in seconds [2]:
Extended commands [n]:
Sweep range of sizes [n]:
Type escape sequence to abort.
Sending 5, 100-byte ICMP Echos to 192.168.7.27, timeout is 2 seconds:
!!!!!!
Success rate is 100 percent, round-trip min/avg/max = 1/2/4 ms
```

Sample output for the ping command when you ping the IP hostname donald:

```
Router# ping donald

Type escape sequence to abort.
Sending 5, 100-byte ICMP Echos to 192.168.7.27, timeout is 2 seconds:
!!!!!!
Success rate is 100 percent, round-trip min/avg/max = 1/3/4 ms
```

Saving Your Router Configuration

This section describes how to avoid losing your configuration at the next system reload or power cycle by saving the running configuration to the startup configuration in NVRAM. The NVRAM provides 256 KB of storage on the router.

These are the required summary steps to avoid losing your configuration at the next system reload:

1. **enable**
2. **copy running-config startup-config**

Table 9 Detailed Steps

	Command or Action	Purpose
Step 1	enable Example: Router> enable	Enables privileged EXEC mode. ■ Enter your password if prompted.
Step 2	copy running-config startup-config Example: Router# copy running-config startup-config	Saves the running configuration to the startup configuration.

Saving Backup Copies of Configuration and System Image

To aid file recovery and minimize downtime in case of file corruption, we recommend that you save backup copies of the startup configuration file and the Cisco IOS software system image file on a server.

These are the required summary steps to aid file recovery and minimize downtime:

1. **enable**
2. **copy nvram:startup-config {ftp: | rcp: | tftp:}**
3. **show {flash0 | flash1}:**
4. **copy {flash0 | flash1}: {ftp: | rcp: | tftp:}**

Table 10 Detailed Steps

	Command or Action	Purpose
Step 1	<p>enable</p> <p>Example: Router> enable</p>	<p>Enables privileged EXEC mode.</p> <ul style="list-style-type: none"> ■ Enter your password if prompted.
Step 2	<p>copy nvram:startup-config {ftp: rcp: tftp:}</p> <p>Example: Router# copy nvram:startup-config ftp:</p>	<p>Copies the startup configuration file to a server.</p> <ul style="list-style-type: none"> ■ Configuration file copy can serve as a backup copy. ■ Enter the destination URL when prompted.
Step 3	<p>show {flash0 flash1}:</p> <p>Example: Router# show {flash0 flash1}:</p>	<p>Displays the layout and contents of a flash memory file system.</p> <ul style="list-style-type: none"> ■ Learn the name of the system image file.
Step 4	<p>copy {flash0 flash1}: {ftp: rcp: tftp:}</p> <p>Example: Router# copy {flash0 flash1}: ftp:</p>	<p>Copies a file from flash memory to a server.</p> <ul style="list-style-type: none"> ■ Copy the system image file to a server to serve as a backup copy. ■ Enter the filename and destination URL when prompted.

EXAMPLES

Copying the Startup Configuration to a TFTP Server:

The following example shows the startup configuration being copied to a TFTP server:

```
Router# copy nvram:startup-config tftp:
Remote host[]? 172.16.101.101
Name of configuration file to write [rtr2-config]? <cr>
Write file rtr2-config on host 172.16.101.101?[confirm] <cr>
![OK]
```

Copying from Flash Memory to a TFTP Server:

The following example shows the use of the **show {flash0 | flash1}:** command in privileged EXEC mode to determine the name of the system image file, and the use of the **copy {flash0|flash1}: tftp:** command in privileged EXEC mode to copy the system image to a TFTP server. The router uses the default username and password.

```
Router# show {flash0|flash1}:
System flash directory:
File Length Name/status
1 4137888 cCGR2010-c2is-mz
[4137952 bytes used, 12639264 available, 16777216 total]
16384K bytes of processor board System flash (Read/Write)\

Router# copy {flash0|flash1}: tftp:
IP address of remote host [255.255.255.255]? 172.16.13.110
filename to write on tftp host? cCGR2010-c2is-mz
```

Verifying the Initial Configuration

```
writing cCGR2010-c2is-mz !!!!!...  
successful ftp write.
```

Note: To avoid losing work you have completed, be sure to save your configuration occasionally as you proceed. Use the **copy running-config startup-config** command to save the configuration to NVRAM.

Verifying the Initial Configuration

Enter the following commands in the Cisco IOS to verify the initial configuration on the router:

- **show version**—Displays the system hardware version; the installed software version; the names and sources of configuration files; the boot images; and the amount of installed DRAM, NVRAM, and flash memory.
- **show diag**—Lists and displays diagnostic information about the installed controllers, interface processors, and port adapters.
- **show interfaces**—Shows interfaces are operating correctly and that the interfaces and line protocol are in the correct state—up or down.
- **show ip interface brief**—Displays a summary status of the interfaces configured for IP protocol.
- **show configuration**—Verifies that you have configured the correct hostname and password.

When you have completed and verified the initial configuration, the specific features and functions are ready to be configured. See the *Cisco Connected Grid Router 2010 Software Configuration Guide*.

Note: If you need help with the interface and port numbering, see [Slot, Port, and Interface Information, page 11](#).



Installing and Upgrading Internal Modules

This section describes how to install and upgrade internal modules in Cisco CGR 2010 router in the following sections:

- [Safety Warnings, page 77](#)
- [Removing and Installing Compact Flash Memory Cards, page 77](#)
- [Installing SFP Modules, page 81](#)
- [Installing Grid Router WAN Interface Cards, page 82](#)

Note: Before you perform any module replacement, read [Safety Warnings, page 77](#) and disconnect power when noted.

Safety Warnings

Warning: Only trained and qualified personnel should be allowed to install, replace, or service this equipment. Statement 1030

Warning: Do not work on the system or connect or disconnect cables during periods of lightning activity. Statement 1001

Warning: Read the installation instructions before connecting the system to the power source. Statement 1004

Warning: Hazardous network voltages are present in WAN ports regardless of whether power to the unit is OFF or ON. To avoid electric shock, use caution when working near WAN ports. When detaching cables, detach the end away from the unit first. Statement 1026

Removing and Installing Compact Flash Memory Cards

This section describes installing and replacing compact flash (CF) memory cards in Cisco CGR 2010 routers. It contains the following sections:

- [Preventing Electrostatic Discharge Damage, page 77](#)
- [Removing a Compact Flash Memory Card, page 78](#)
- [Installing a Compact Flash Memory Card, page 80](#)

Preventing Electrostatic Discharge Damage

Compact flash memory cards are sensitive to electrostatic discharge (ESD) damage, which can occur when electronic cards or components are handled improperly, results in complete or intermittent failures.

To prevent ESD damage, follow these guidelines:

- Always use an ESD wrist or ankle strap and ensure that it makes good skin contact.
- Connect the equipment end of the strap to an unfinished chassis surface.

- Place a removed compact flash memory card on an antistatic surface or in a static shielding bag. If the card will be returned to the factory, immediately place it in a static shielding bag.
- Avoid contact between the card and clothing. The wrist strap protects the card from ESD voltages on the body only; ESD voltages on clothing can still cause damage.
- Do not remove the wrist strap until the installation is complete.

Caution: For safety, periodically check the resistance value of the antistatic strap. The measurement should be between 1 and 10 megohms (Mohms).

Removing a Compact Flash Memory Card

Caution: Do not remove a compact flash memory card from the chassis while it is being accessed. The CF LED blinks to indicate when flash memory is being accessed. Removing the compact flash memory card from the router while flash memory is being accessed can cause data corruption and erratic operation.

To remove a compact flash memory card from the chassis:

1. Remove the compact flash cover by placing a flat-blade screwdriver in the slot and pushing sideways against the tension to release the cover door (see [Figure 1 on page 78](#) and [Figure 2 on page 79](#)).

Figure 1 Inserting Screwdriver Into the Compact Flash Cover

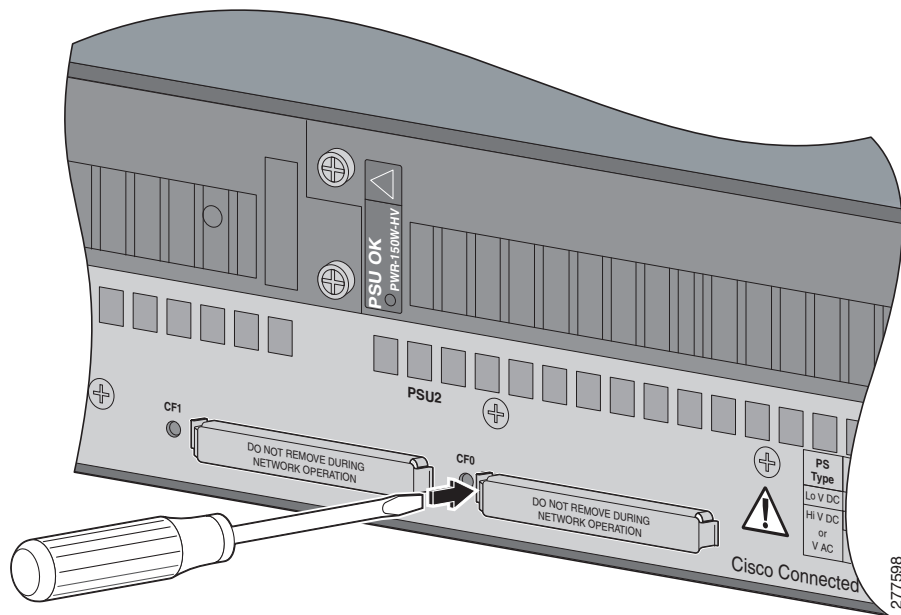
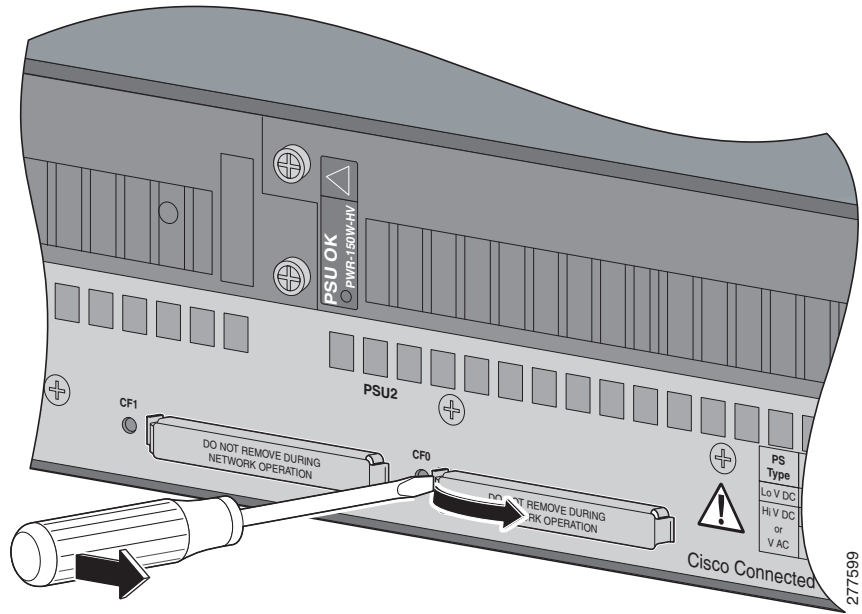
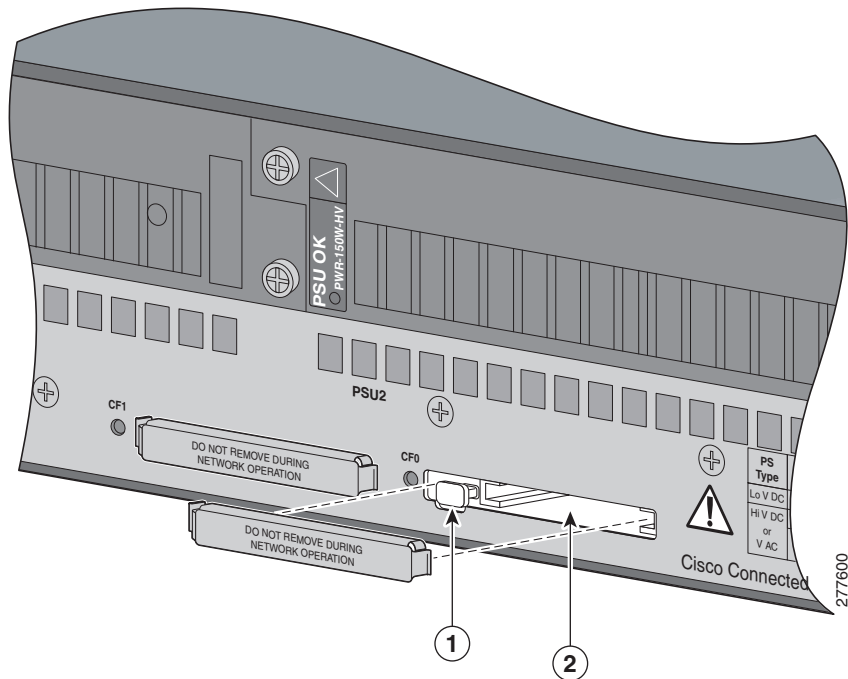

Figure 2 Removing the Compact Flash Cover



2. Press the ejector button next to the compact flash memory card. The ejector button moves outward so that it projects from the panel.

Figure 3 Compact Flash Memory Card Slot in Cisco CGR 2010



1 Ejector button

2 Compact flash slot

3. Press the ejector button again (see [Figure 3 on page 80](#)). This ejects the compact flash memory card part-way out of its slot.
4. Pull the compact flash memory card out of its slot.
5. Push the ejector button in until the button is flush with the bezel.

Caution: To prevent damage to the ejector mechanism, the ejector button must remain pressed in all the way (flush against the bezel) when not being used to eject a compact flash memory card.

Installing a Compact Flash Memory Card

To install a compact flash memory card:

1. Ensure that the ejector button is fully seated until it is flush with the bezel.

Note: If the ejector button is projecting out from the panel, push it in until it is flush with the bezel.

2. Insert the compact flash memory card into the slot until it is fully seated. The ejector button remains flush with the panel.

Note: If the ejector button is projecting from the panel after you insert the compact flash memory card, remove the compact flash memory card, press the ejector button until it clicks, and reinsert the compact flash memory card.

Caution: To prevent damage to the ejector mechanism, the ejector button must remain fully seated when not being used to eject a compact flash memory card.

3. Replace the compact flash cover by inserting the cover lip into the chassis then pushing the over to snap it back into place.

Installing SFP Modules

This section describes how to install optional small-form-factor pluggable (SFP) modules in Cisco CGR 2010 routers to provide optical Gigabit Ethernet connectivity.

The rugged SFP SKUs supported on the Cisco CGR 2010 router:

- GLC-FE-100FX-RGD=
- GLC-FE-100LX-RGD=
- GLC-SX-MM-RGD=
- GLC-LX-SM-RGD=
- GLC-ZX-SM-RGD=

The SFP module installs into a slot on the router's cable side panel. When selected in Cisco IOS software, it is assigned port **gigabitethernet 0/0**. The default is the built-in RJ-45 1000 Base-T connector, which is enabled on this port.

Tip: Use the **show controller** command at the Cisco IOS prompt to determine whether you are using an SFP certified by Cisco.

Laser Safety Guidelines

Optical SFPs use a small laser to generate the fiber-optic signal. Keep the optical transmit and receive ports covered whenever a cable is not connected to the port.

To install an SFP module in a Cisco CGR 2010 router:

1. Slide the SFP into the router connector until it locks into position (see [Figure 4 on page 81](#)).

Tip: If the SFP uses a bale-clasp latch (see [Figure 4 on page 81](#)), the handle should be on top of the SFP module.

Figure 4 Installing an SFP Module

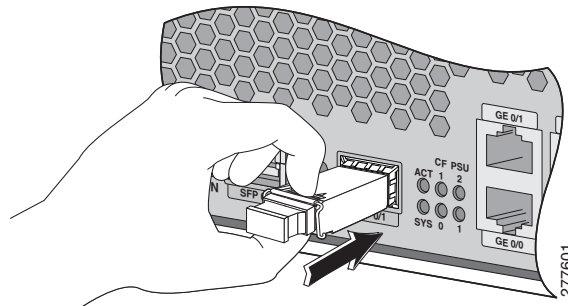

Caution: Do not remove the optical port plugs from the SFP until you are ready to connect cabling.

2. Connect the network cable to the SFP module.

Removing SFP Modules

To remove an SFP from a Cisco CGR 2010 router:

1. Disconnect all cables from the SFP.

Caution: The latching mechanism used on many SFPs locks the SFP into place when cables are connected. Do not pull on the cabling in an attempt to remove the SFP.

2. Disconnect the SFP latch (see [Figure 5 on page 82](#)).

Note: SFP modules use various latch designs to secure the module in the SFP port. Latch designs are not linked to SFP model or technology type. For information on the SFP technology type and model, see the label on the side of the SFP.

Figure 5 Disconnecting SFP Latch Mechanisms

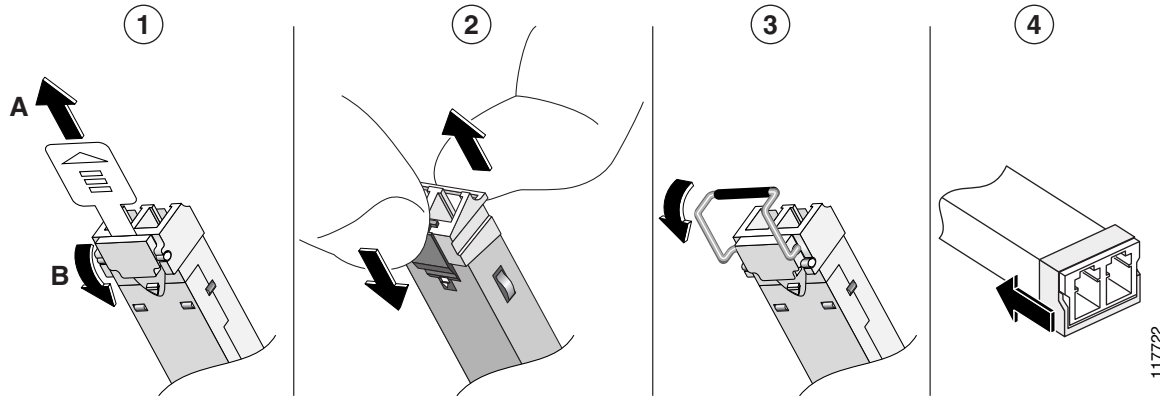

- | | |
|-------------------------|------------------------|
| 1 Sliding latch | 3 Bale-clasp latch |
| 2 Swing and slide latch | 4 Plastic collar latch |

Tip: Use a pen, screwdriver, or other small straight tool to gently release a bale-clasp handle if you cannot reach it with your fingers.

3. Grasp the SFP on both sides and remove it from the router.

Installing Grid Router WAN Interface Cards

This section describes how to install grid router WAN interface cards (GRWIC) in Cisco CGR 2010 routers.

The router can accommodate four single-wide GRWICS, or two single-wide GRWICs and one double-wide GRWIC, or two double-wide GRWICs at any one time.

Installing Single-Wide GRWICs

A single-wide GRWIC installs into one of four slots on the cable side panel of the router (see [Figure 6 on page 83](#)).

Figure 6 Single-Wide GRWICs for the Cisco CGR 2010 Router

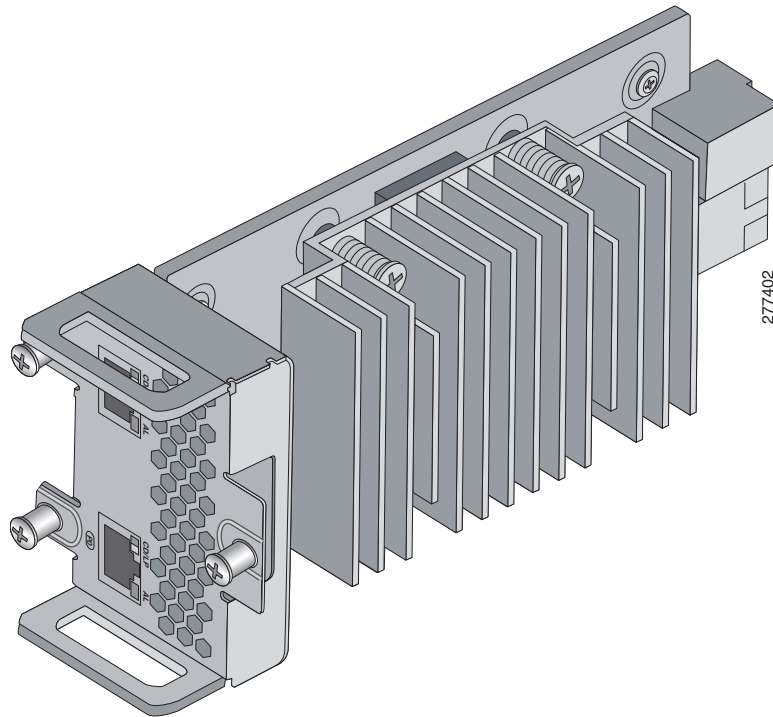

To install a single-wide GRWIC in a Cisco CGR 2010 router:

1. Slide the single-wide GRWIC in to the router slot (see [Figure 7 on page 83](#)).

Figure 7 Proper Installation of Multiple GRWICs

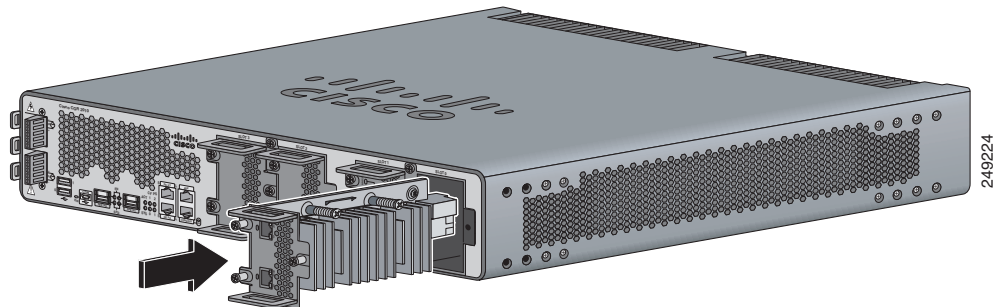

2. Tighten the three captive screws on the front of the interface card.

Caution: For T1/E1 interfaces, shielded cables are required to meet EN55022, Cisp 22, and EN300-386 compliance.

Note: When installing multiple GRWICs, the GRWICs must overlap, as shown in [Figure 8 on page 84](#), to ensure a secure fit.

Figure 8 Proper Installation of Multiple GRWICs

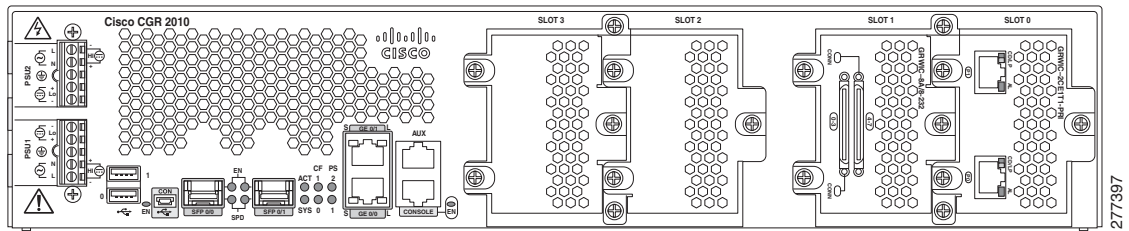

Installing Double-Wide GRWICs

To install the double-wide GRWICs in the Cisco CGR 2010 router:

1. Before you install (or remove) a double-wide GRWIC in the host CGR 2010 router, you must power down the router as described in [Shutting Off Power, page 37](#).
2. Facing the I/O side of the Cisco CGR 2010 router, use a No. 2 Phillips screwdriver to remove the slot divider between the slots where you intend to install the switch module (either slots 0 and 1 or slots 2 and 3). See [Figure 9 on page 84](#).
 - a. Remove the two screws on the slot divider.
 - b. Remove the slot divider and set it aside.

Figure 9 Removing the Slot Divider From the CGR 2010 Router

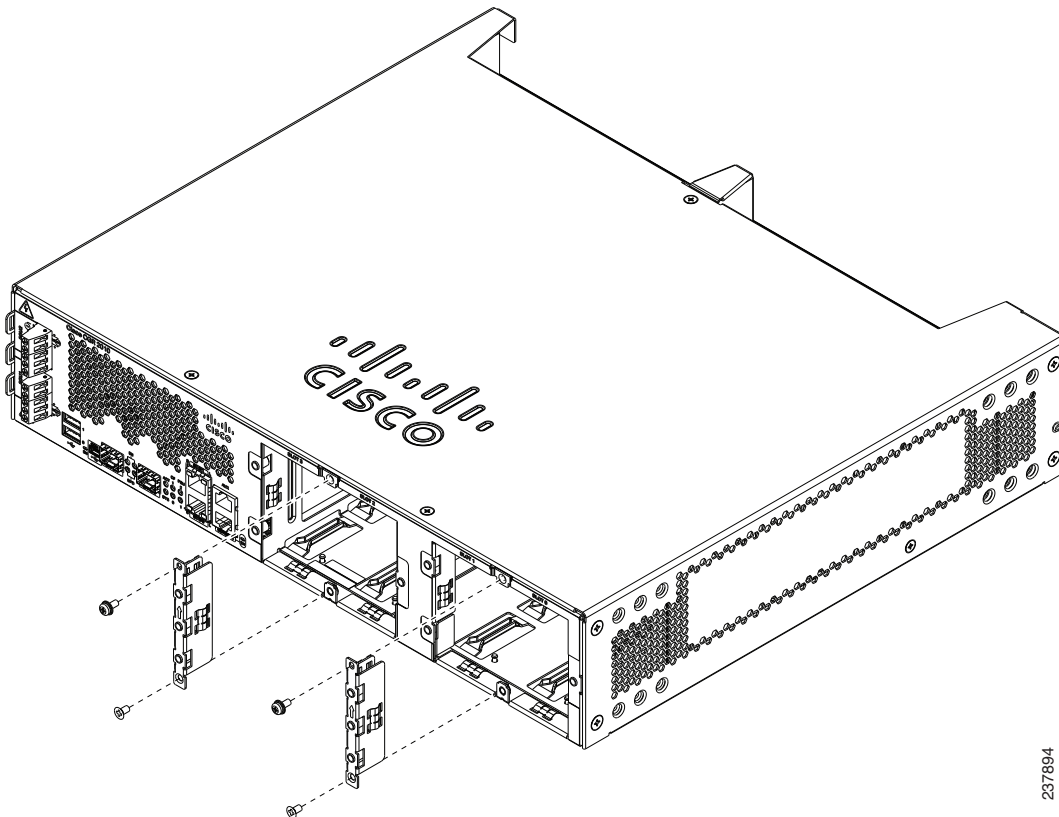

3. Stand the GRWIC on end to install it into the Cisco CGR 2010 router slot (see [Figure 10 on page 85](#)).

Figure 10 Positioning the Double-Wide GRWIC to Install in the Router

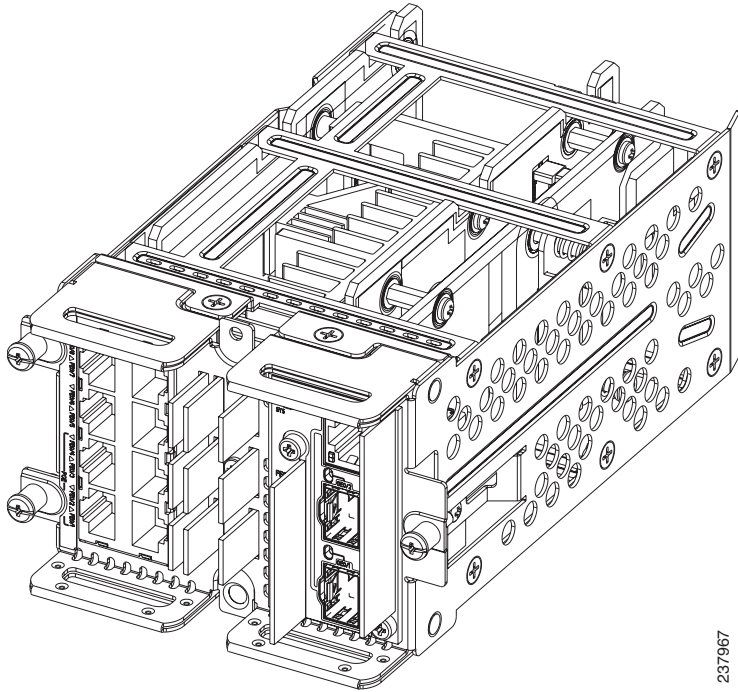

237967

4. Grasp the handles and carefully slide the module into the card guide, then push with both hands until the module is flush against the router chassis (see [Figure 11 on page 86](#)).

Figure 11 Installing the Switch Module in the CGR 2010 Router

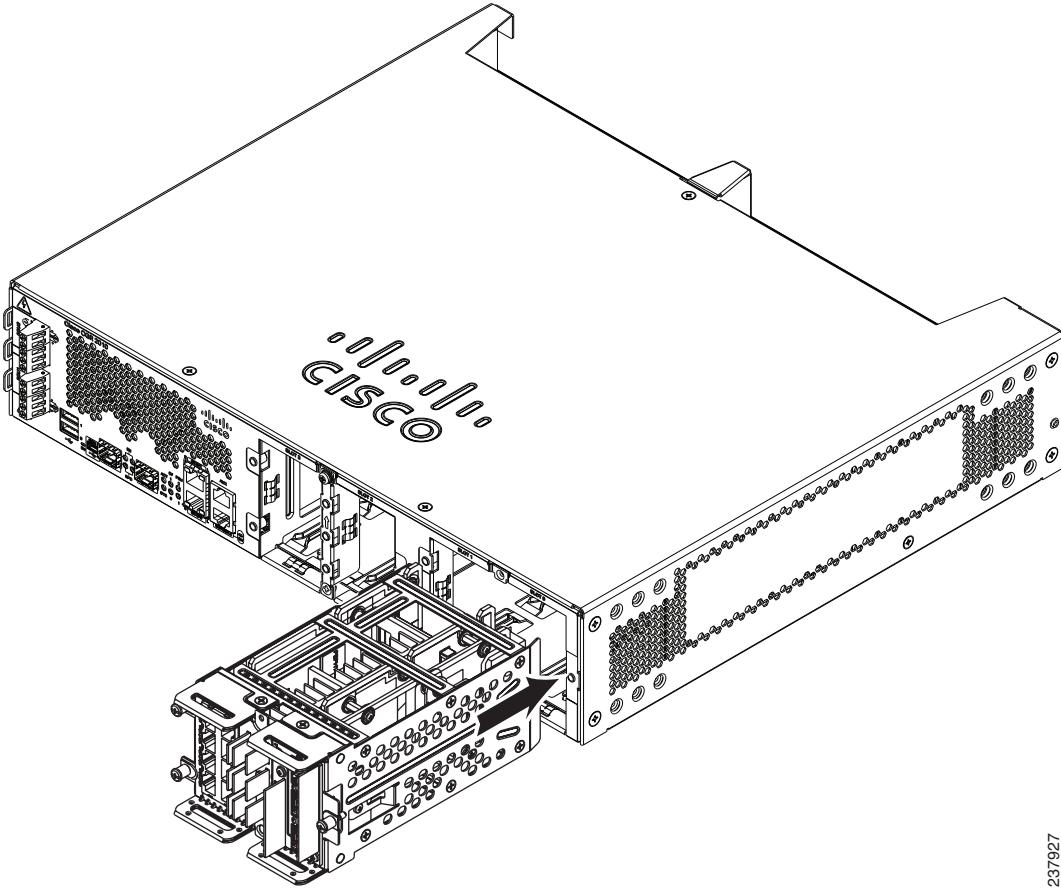

237927

5. Tighten the screws in the order specified here:
 - a. First tighten the lower flathead screw to the bottom center hole.
 - b. Then tighten the second panhead screw to the top center hole.
6. Tighten the three captive screws on the front of the module in this order:
 - a. First tighten the captive screw on the lower left of the module.
 - b. Then tighten the single captive screw on the right side of the module.
 - c. Finally, tighten the captive screw on the upper left of the module.

The double-wide GRWIC is now successfully installed in the router (see [Figure 12 on page 87](#)).

Figure 12 The Double-Wide GRWIC Installed in the CGR 2010 Router

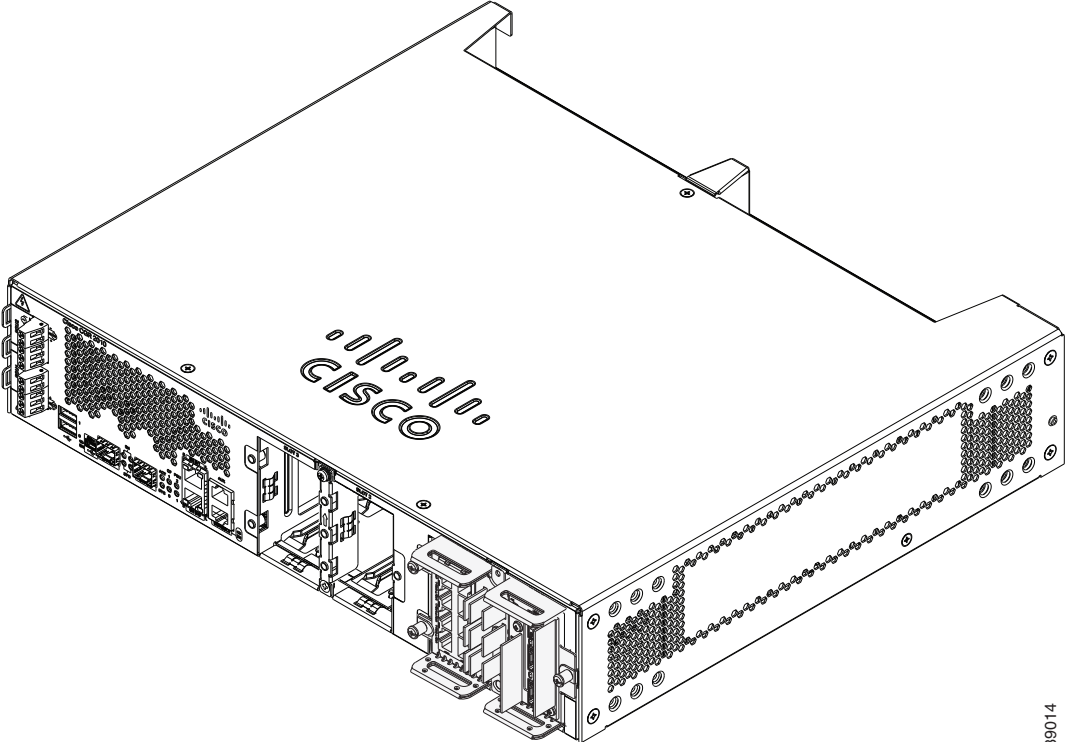

239014

