

APPLICATION FOR LOW VOLTAGE DIRECTIVE

On Behalf of

INVT POWER SYSTEM(SHENZHEN) CO., LTD

Uninterruptible Power Systems

**Model(s): RM080/40X, RM100/50X, RM120/40X, RM150/50X, RM160/40X,
RM200/50X, RM240/40X, RM250/50X, RM300/50X, RM320/40X, RM360/40X,
RM400/40X, RM450/50X, RM500/50X, RM400/50X**

**Prepared For : INVT POWER SYSTEM (SHENZHEN) CO., LTD
5th Floor, 1#Building, Gaofa Industrial Park, LongJing,
Nanshan District, Shenzhen, China, 518055**

**Prepared By : EMTEK (SHENZHEN) CO., LTD.
Bldg 69, Majialong Industry Zone, Nanshan District,
Shenzhen, Guangdong, China
Tel: +86-755-26954280
Fax: +86-755-26954282**

TEST REPORT IEC 62040-1 Uninterruptible power systems (UPS) – Part 1: General and safety requirements for UPS	
Report Number.	ES160617015S
Date of issue	Oct. 31, 2016
Total number of pages	93 pages
Applicant's name	INVT POWER SYSTEM(SHENZHEN) CO., LTD
Address	5th Floor, 1#Building, Gaofa Industrial Park, LongJing, Nanshan District, Shenzhen, China, 518055
Test specification:	
Standard	IEC 62040-1:2008 (First Edition) + Am 1:2013
Test procedure	Compliance with IEC 62040-1:2008 (First Edition) + Am 1:2013
Non-standard test method	N/A
Test Report Form No.	IEC62040_1C
Test Report Form(s) Originator	TÜV Rheinland Japan Ltd.
Master TRF	Dated 2014-01
<p>Copyright © 2014 Worldwide System for Conformity Testing and Certification of Electrotechnical Equipment and Components (IECEE), Geneva, Switzerland. All rights reserved.</p> <p>This publication may be reproduced in whole or in part for non-commercial purposes as long as the IECEE is acknowledged as copyright owner and source of the material. IECEE takes no responsibility for and will not assume liability for damages resulting from the reader's interpretation of the reproduced material due to its placement and context.</p> <p>If this Test Report Form is used by non-IECEE members, the IECEE/IEC logo and the reference to the CB Scheme procedure shall be removed.</p> <p>This report is not valid as a CB Test Report unless signed by an approved CB Testing Laboratory and appended to a CB Test Certificate issued by an NCB in accordance with IECEE 02.</p>	
Test item description	Uninterruptible Power Systems
Trade Mark	INVT
Manufacturer	INVT POWER SYSTEM(SHENZHEN) CO., LTD
Address	5th Floor, 1#Building, Gaofa Industrial Park, LongJing, Nanshan District, Shenzhen, China, 518055
Model/Type reference	RM080/40X, RM100/50X, RM120/40X, RM150/50X, RM160/40X, RM200/50X, RM240/40X, RM250/50X, RM300/50X, RM320/40X, RM360/40X, RM400/40X, RM450/50X, RM500/50X, RM400/50X
Ratings	See the rating label

Testing procedure and testing location:		
<input checked="" type="checkbox"/>	Testing Laboratory:	EMTEK (SHENZHEN) CO., LTD.
Testing location/ address		Bldg 69, Majialong Industry Zone, Nanshan District, Shenzhen, Guangdong, China
<input type="checkbox"/>	Associated Testing Laboratory:	
Testing location/ address		
Tested by (name + signature)		Gary Zhang 
Approved by (name + signature)		William Guo 
<input type="checkbox"/>	Testing procedure: TMP	
Testing location/ address		
Tested by (name + signature)		
Approved by (name + signature)		
<input type="checkbox"/>	Testing procedure: WMT	
Testing location/ address		
Tested by (name + signature)		
Witnessed by (name + signature)		
Approved by (name + signature)		
<input type="checkbox"/>	Testing procedure: SMT	
Testing location/ address		
Tested by (name + signature)		
Approved by (name + signature)		
Supervised by (name + signature) ..		

List of Attachments (including a total number of pages in each attachment):

- Pages 1 to 74 for IEC 62040-1 TRF (main report)
- Pages 74 to 75 for Appendix 1: European group differences and national differences
- Pages 76 to 92 for Appendix 2: Product photo

Summary of testing:

From the result of our tests on the submitted samples, we conclude they comply with the requirements of the standards IEC 62040-1:2008 (First Edition) + Am 1:2013

Tests performed (name of test and test clause):

The submitted samples were found to comply with the requirements of:

- IEC 62040-1:2008+A1:2013
- EN 62040-1:2008+A1:2013

Testing location:

**EMTEK (SHENZHEN) CO., LTD.
Bldg 69, Majialong Industry Zone, Nanshan District, Shenzhen, Guangdong, China**

Summary of compliance with National Differences



List of countries addressed: Group differences and national differences for CENELEC countries were checked.

The product fulfils the requirements of EN 62040-1: 2008+A1: 2013.

Copy of marking plate

The artwork below may be only a draft. The use of certification marks on a product must be authorized by the respective NCBs that own these marks.

1. Rating label for model RM080/40X:

	RM080/40X
UPS	80kVA 3Ø+N+PE
RETE 1 - MAINS 1 - NETZ 1	3Ø+N
Uin (Vac)	380/400/415
Iin (A)	115*
Frequenza - Frequency - Frequenz	50÷60Hz
RETE 2 - MAINS 2 - NETZ 2	3Ø+N
Uin (Vac)	380/400/415
Iin (A)	122*
Frequenza - Frequency - Frequenz	50÷60Hz
USCITA - OUTPUT - AUSGANG	3Ø+N
Uout (Vac)	380/400/415
Iout (A)	122*
Frequenza - Frequency - Frequenz	50÷60Hz
Potenza - Power rating - Leistung	80kVA/72kW (*:@380V)
Icw	10 kA
BATTERIA - BATTERY - BATTERIE	
Udc (Vdc)	+/- 240
I _{dc} (A)	160
N° Serie - Serial Number - Seriennummer	
Year of construction	2016
5th Floor, 1# Buiding, Gaofa Industrial Park, Longjing, Nanshan District, Shenzhen, China ,518055	
 Made in China	 210 kg
Service: www.invt-power.com	



2. Rating label for model RM100/50X



RM100/50X

UPS

100kVA 3Ø+N+PE

RETE 1 - MAINS 1 - NETZ 1	3Ø+N
Uin (Vac)	380/400/415
Iin (A)	144*
Frequenza - Frequency - Frequenz	50÷60Hz

RETE 2 - MAINS 2 - NETZ 2	3Ø+N
Uin (Vac)	380/400/415
Iin (A)	152*
Frequenza - Frequency - Frequenz	50÷60Hz

USCITA - OUTPUT - AUSGANG	3Ø+N
Uout (Vac)	380/400/415
Iout (A)	152*
Frequenza - Frequency - Frequenz	50÷60Hz
Potenza - Power rating - Leistung	100kVA/90kW (*:@380V)

Icw	10 kA
------------	--------------

BATTERIA - BATTERY - BATTERIE	
Udc (Vdc)	+/- 240
I _{dc} (A)	200

N° Serie - Serial
Number -
Seriennumber

Year of construction	2016
-----------------------------	-------------

5th Floor, 1# Buiding, Gaofa Industrial Park,
Longjing, Nanshan District, Shenzhen,
China ,518055





210 kg





Service: www.invt-power.com

3. Rating label for model RM120/40X

	RM120/40X
UPS	120kVA 3Ø+N+PE
RETE 1 - MAINS 1 - NETZ 1	3Ø+N
Uin (Vac)	380/400/415
Iin (A)	173*
Frequenza - Frequency - Frequenz	50÷60Hz
RETE 2 - MAINS 2 - NETZ 2	3Ø+N
Uin (Vac)	380/400/415
Iin (A)	182*
Frequenza - Frequency - Frequenz	50÷60Hz
USCITA - OUTPUT - AUSGANG	3Ø+N
Uout (Vac)	380/400/415
Iout (A)	182*
Frequenza - Frequency - Frequenz	50÷60Hz
Potenza - Power rating - Leistung	120kVA/108kW (*:@380V)
Icw	10 kA
BATTERIA - BATTERY - BATTERIE	
Udc (Vdc)	+/- 240
Idc (A)	240
N° Serie - Serial Number - Seriennummer	
Year of construction	2016
5th Floor, 1# Buiding, Gaofa Industrial Park, Longjing, Nanshan District, Shenzhen, China ,518055	
 Made in China	 305 kg
Service: www.invt-power.com	



4. Rating label for model RM150/50X

	RM150/50X
UPS	150kVA 3Ø+N+PE
RETE 1 - MAINS 1 - NETZ 1	3Ø+N
Uin (Vac)	380/400/415
Iin (A)	216*
Frequenza - Frequency - Frequenz	50÷60Hz
RETE 2 - MAINS 2 - NETZ 2	3Ø+N
Uin (Vac)	380/400/415
Iin (A)	226*
Frequenza - Frequency - Frequenz	50÷60Hz
USCITA - OUTPUT - AUSGANG	3Ø+N
Uout (Vac)	380/400/415
Iout (A)	226*
Frequenza - Frequency - Frequenz	50÷60Hz
Potenza - Power rating - Leistung	150kVA/135kW (*:@380V)
Icw	10 kA
BATTERIA - BATTERY - BATTERIE	
Udc (Vdc)	+/- 240
Idc (A)	300
N° Serie - Serial Number - Seriennummer	
Year of construction	2016
5th Floor, 1# Buiding, Gaofa Industrial Park, Longjing, Nanshan District, Shenzhen, China ,518055	
 Made in China	 305 kg
Service: www.invt-power.com	



5. Rating label for model RM160/40X



RM160/40X

UPS

160kVA 3Ø+N+PE

RETE 1 - MAINS 1 - NETZ 1	3Ø+N
Uin (Vac)	380/400/415
Iin (A)	230*
Frequenza - Frequency - Frequenz	50÷60Hz

RETE 2 - MAINS 2 - NETZ 2	3Ø+N
Uin (Vac)	380/400/415
Iin (A)	242*
Frequenza - Frequency - Frequenz	50÷60Hz

USCITA - OUTPUT - AUSGANG	3Ø+N
Uout (Vac)	380/400/415
Iout (A)	242*
Frequenza - Frequency - Frequenz	50÷60Hz
Potenza - Power rating - Leistung	160kVA/144kW (*:@380V)

Icw	10 kA
------------	--------------

BATTERIA - BATTERY - BATTERIE	
Udc (Vdc)	+/- 240
I _{dc} (A)	320

N° Serie - Serial
Number -
Seriennumber

Year of construction	2016
-----------------------------	-------------

5th Floor, 1# Buiding, Gaofa Industrial Park,
Longjing, Nanshan District, Shenzhen,
China ,518055





350 kg



Service: www.invt-power.com

6. Rating label for model RM200/50X

	RM200/50X
UPS	200kVA 3Ø+N+PE
RETE 1 - MAINS 1 - NETZ 1	3Ø+N
Uin (Vac)	380/400/415
Iin (A)	288*
Frequenza - Frequency - Frequenz	50÷60Hz
RETE 2 - MAINS 2 - NETZ 2	3Ø+N
Uin (Vac)	380/400/415
Iin (A)	303*
Frequenza - Frequency - Frequenz	50÷60Hz
USCITA - OUTPUT - AUSGANG	3Ø+N
Uout (Vac)	380/400/415
Iout (A)	303*
Frequenza - Frequency - Frequenz	50÷60Hz
Potenza - Power rating - Leistung	200kVA/180kW (*:@380V)
Icw	10 kA
BATTERIA - BATTERY - BATTERIE	
Udc (Vdc)	+/- 240
Idc (A)	400
N° Serie - Serial Number - Seriennummer	
Year of construction	2016
5th Floor, 1# Buiding, Gaofa Industrial Park, Longjing, Nanshan District, Shenzhen, China ,518055	
 Made in China	 350 kg
Service: www.invt-power.com	



7. Rating label for model RM240/40X:



RM240/40X

UPS

240kVA 3Ø+N+PE

RETE 1 - MAINS 1 - NETZ 1	3Ø+N
Uin (Vac)	380/400/415
Iin (A)	346*
Frequenza - Frequency - Frequenz	50÷60Hz

RETE 2 - MAINS 2 - NETZ 2	3Ø+N
Uin (Vac)	380/400/415
Iin (A)	364*
Frequenza - Frequency - Frequenz	50÷60Hz

USCITA - OUTPUT - AUSGANG	3Ø+N
Uout (Vac)	380/400/415
Iout (A)	364*
Frequenza - Frequency - Frequenz	50÷60Hz
Potenza - Power rating - Leistung	240kVA/216kW (*:@380V)

Icw	10 kA
------------	--------------

BATTERIA - BATTERY - BATTERIE	
Udc (Vdc)	+/- 240
I dc (A)	480

N° Serie - Serial
Number -
Seriennumber

Year of construction	2016
-----------------------------	-------------

5th Floor, 1# Buiding, Gaofa Industrial Park,
Longjing, Nanshan District, Shenzhen,
China ,518055



490 kg



Service: www.invt-power.com

8. Rating label for model RM250/50X:



RM250/50X

UPS

250kVA 3Ø+N+PE

RETE 1 - MAINS 1 - NETZ 1	3Ø+N
Uin (Vac)	380/400/415
Iin (A)	360*
Frequenza - Frequency - Frequenz	50÷60Hz

RETE 2 - MAINS 2 - NETZ 2	3Ø+N
Uin (Vac)	380/400/415
Iin (A)	380*
Frequenza - Frequency - Frequenz	50÷60Hz

USCITA - OUTPUT - AUSGANG	3Ø+N
Uout (Vac)	380/400/415
Iout (A)	380*
Frequenza - Frequency - Frequenz	50÷60Hz
Potenza - Power rating - Leistung	250kVA/225kW (*:@380V)

Icw	10 kA
------------	--------------

BATTERIA - BATTERY - BATTERIE	
Udc (Vdc)	+/- 240
I _{dc} (A)	500

N° Serie - Serial
Number -
Seriennumber

Year of construction	2016
-----------------------------	-------------

5th Floor, 1# Buiding, Gaofa Industrial Park,
Longjing, Nanshan District, Shenzhen,
China ,518055



445 kg



Service: www.invt-power.com

9. Rating label for model RM300/50X:



RM300/50X

UPS

300kVA 3Ø+N+PE

RETE 1 - MAINS 1 - NETZ 1	3Ø+N
Uin (Vac)	380/400/415
Iin (A)	432*
Frequenza - Frequency - Frequenz	50÷60Hz

RETE 2 - MAINS 2 - NETZ 2	3Ø+N
Uin (Vac)	380/400/415
Iin (A)	456*
Frequenza - Frequency - Frequenz	50÷60Hz

USCITA - OUTPUT - AUSGANG	3Ø+N
Uout (Vac)	380/400/415
Iout (A)	456*
Frequenza - Frequency - Frequenz	50÷60Hz
Potenza - Power rating - Leistung	300kVA/270kW (*:@380V)

Icw	10 kA
------------	--------------

BATTERIA - BATTERY - BATTERIE	
Udc (Vdc)	+/- 240
Idc (A)	600

**N° Serie - Serial
Number -
Seriennumber**

Year of construction	2016
-----------------------------	-------------

5th Floor, 1# Buiding, Gaofa Industrial Park,
Longjing, Nanshan District, Shenzhen,
China ,518055



490 kg



Service: www.invt-power.com

10. Rating label for model RM320/40X:



RM320/40X

UPS

320kVA 3Ø+N+PE

RETE 1 - MAINS 1 - NETZ 1	3Ø+N
Uin (Vac)	380/400/415
Iin (A)	461*
Frequenza - Frequency - Frequenz	50÷60Hz

RETE 2 - MAINS 2 - NETZ 2	3Ø+N
Uin (Vac)	380/400/415
Iin (A)	488*
Frequenza - Frequency - Frequenz	50÷60Hz

USCITA - OUTPUT - AUSGANG	3Ø+N
Uout (Vac)	380/400/415
Iout (A)	488*
Frequenza - Frequency - Frequenz	50÷60Hz
Potenza - Power rating - Leistung	320kVA/288kW (*:@380V)

Icw	10 kA
------------	--------------

BATTERIA - BATTERY - BATTERIE	
Udc (Vdc)	+/- 240
I _{dc} (A)	640

**N° Serie - Serial
Number -
Seriennumber**

Year of construction	2016
-----------------------------	-------------

5th Floor, 1# Buiding, Gaofa Industrial Park,
Longjing, Nanshan District, Shenzhen,
China ,518055



810 kg



Service: www.invt-power.com

11. Rating label for model RM360/40X:



RM360/40X

UPS

360kVA 3Ø+N+PE

RETE 1 - MAINS 1 - NETZ 1	3Ø+N
Uin (Vac)	380/400/415
Iin (A)	518*
Frequenza - Frequency - Frequenz	50÷60Hz

RETE 2 - MAINS 2 - NETZ 2	3Ø+N
Uin (Vac)	380/400/415
Iin (A)	546*
Frequenza - Frequency - Frequenz	50÷60Hz

USCITA - OUTPUT - AUSGANG	3Ø+N
Uout (Vac)	380/400/415
Iout (A)	546*
Frequenza - Frequency - Frequenz	50÷60Hz
Potenza - Power rating - Leistung	360kVA/324kW
	(*:@380V)

Icw	11 kA
------------	--------------

BATTERIA - BATTERY - BATTERIE	
Udc (Vdc)	+/- 240
Idc (A)	720

**N° Serie - Serial
Number -
Seriennummer**

Year of construction	2016
-----------------------------	-------------

5th Floor, 1# Buiding, Gaofa Industrial Park,
Longjing, Nanshan District, Shenzhen,
China ,518055





CE Made in
China



855 kg

Service: www.invt-power.com

12. Rating label for model RM400/40X:

	RM400/40X
UPS	400kVA 3Ø+N+PE
RETE 1 - MAINS 1 - NETZ 1	3Ø+N
U _{in} (Vac)	380/400/415
I _{in} (A)	576*
Frequenza - Frequency - Frequenz	50÷60Hz
RETE 2 - MAINS 2 - NETZ 2	3Ø+N
U _{in} (Vac)	380/400/415
I _{in} (A)	606*
Frequenza - Frequency - Frequenz	50÷60Hz
USCITA - OUTPUT - AUSGANG	3Ø+N
U _{out} (Vac)	380/400/415
I _{out} (A)	606*
Frequenza - Frequency - Frequenz	50÷60Hz
Potenza - Power rating - Leistung	400kVA/360kW (*:@380V)
I_{cw}	13 kA
BATTERIA - BATTERY - BATTERIE	
U _{dc} (Vdc)	+/- 240
I _{dc} (A)	800
N° Serie - Serial Number - Seriennummer	
Year of construction	2016
5th Floor, 1# Buiding, Gaofa Industrial Park, Longjing, Nanshan District, Shenzhen, China ,518055	
 Made in China	 900 kg
Service: www.invt-power.com	



13. Rating label for model RM400/50X:



RM400/50X

UPS

400kVA 3Ø+N+PE

RETE 1 - MAINS 1 - NETZ 1	3Ø+N
Uin (Vac)	380/400/415
Iin (A)	576*
Frequenza - Frequency - Frequenz	50÷60Hz

RETE 2 - MAINS 2 - NETZ 2	3Ø+N
Uin (Vac)	380/400/415
Iin (A)	606*
Frequenza - Frequency - Frequenz	50÷60Hz

USCITA - OUTPUT - AUSGANG	3Ø+N
Uout (Vac)	380/400/415
Iout (A)	606*
Frequenza - Frequency - Frequenz	50÷60Hz
Potenza - Power rating - Leistung	400kVA/360kW (*:@380V)

Icw	13 kA
------------	--------------

BATTERIA - BATTERY - BATTERIE	
Udc (Vdc)	+/- 240
I dc (A)	800

**N° Serie - Serial
Number -
Seriennumber**

Year of construction	2016
-----------------------------	-------------

5th Floor, 1# Buiding, Gaofa Industrial Park,
Longjing, Nanshan District, Shenzhen,
China ,518055





620 kg



Service: www.invt-power.com

14. Rating label for model RM450/50X:

	RM450/50X
UPS	450kVA 3Ø+N+PE
RETE 1 - MAINS 1 - NETZ 1	3Ø+N
Uin (Vac)	380/400/415
Iin (A)	648*
Frequenza - Frequency - Frequenz	50÷60Hz
RETE 2 - MAINS 2 - NETZ 2	3Ø+N
Uin (Vac)	380/400/415
Iin (A)	678*
Frequenza - Frequency - Frequenz	50÷60Hz
USCITA - OUTPUT - AUSGANG	3Ø+N
Uout (Vac)	380/400/415
Iout (A)	678*
Frequenza - Frequency - Frequenz	50÷60Hz
Potenza - Power rating - Leistung	450kVA/405kW (*:@380V)
Icw	14 kA
BATTERIA - BATTERY - BATTERIE	
Udc (Vdc)	+/- 240
I _{dc} (A)	900
N° Serie - Serial Number - Seriennummer	
Year of construction	2016
5th Floor, 1# Buiding, Gaofa Industrial Park, Longjing, Nanshan District, Shenzhen, China ,518055	
 Made in China	 855 kg
Service: www.invt-power.com	



15. Rating label for model RM500/50X:



RM500/50X

UPS

500kVA 3Ø+N+PE

RETE 1 - MAINS 1 - NETZ 1	3Ø+N
Uin (Vac)	380/400/415
Iin (A)	720*
Frequenza - Frequency - Frequenz	50÷60Hz

RETE 2 - MAINS 2 - NETZ 2	3Ø+N
Uin (Vac)	380/400/415
Iin (A)	760*
Frequenza - Frequency - Frequenz	50÷60Hz

USCITA - OUTPUT - AUSGANG	3Ø+N
Uout (Vac)	380/400/415
Iout (A)	760*
Frequenza - Frequency - Frequenz	50÷60Hz
Potenza - Power rating - Leistung	500kVA/450kW (*:@380V)

Icw	16 kA
------------	--------------

BATTERIA - BATTERY - BATTERIE	
Udc (Vdc)	+/- 240
I dc (A)	1000

**N° Serie - Serial
Number -
Seriennumber**

Year of construction	2016
-----------------------------	-------------

5th Floor, 1# Buiding, Gaofa Industrial Park,
Longjing, Nanshan District, Shenzhen,
China ,518055



900 kg



Service: www.invt-power.com

Manufacturer: INVT POWER SYSTEM (SHENZHEN)
CO., LTD
Address: 5th Floor, 1#Building, Gaofa Industrial Park,
LongJing, Nanshan District, Shenzhen, China, 518055
Importer:XXXXXX
Address: XXXXXX

16. Warning label on outer enclosures for HT33080X, HT33100X

Start-Up
Step 1: Switch On Q4
Step 2: Switch On Q2
Step 3: Switch On Q1

Shutdown
Step 1: Switch Off Q2
Step 2: Switch Off Q1
Step 3: Switch Off Q4

Maintenance
Step 1: Transfer to Bypass manually (From LCD panel)
Step 2: After load on static bypass, Switch On Q3.
Step 3: Switch Off Q2, Q1, Q4
Step 4: Doing Maintenance (make sure battery is disconnected)
Step 5: After maintenance, Switch On Q4, Q2, Q1.
Step 6: After Load on static bypass, Switch off Q3.

17. Warning label on outer enclosures for HT33120X, HT33150X, HT33160X, HT33200X.

 **WARNING**

CHARGED CAPACITORS
DISCHARGE TIME 5 MINUTES AFTER
DISCONNECTION OF UPS AND BATTERY.

 **CAUTION**

- HIGH LEAKAGE CURRENT, EARTH CONNECTION ESSENTIAL BEFORE CONNECTING UPS.
- DO NOT REMOVE COVERS. THIS SYSTEM IS TO BE SERVICED BY QUALIFIED SERVICE PERSONNEL ONLY.
- HAZARDOUS LIVE PARTS INSIDE THIS UPS ARE ENERGIZED FROM THE BATTERY SUPPLY EVEN WHEN THE AC INPUT POWER IS DISCONNECTED.
- SEE USER MANUAL FOR INSTALLATION, OPERATING AND MAINTENANCE INSTRUCTIONS.

OPERATION INSTRUCTION

- BATTERY VOLTAGE&CONNECTION MUST COMPLY WITH UPS SPECIFICATION.
- MANUAL BATTERY DISCHARGE RECOMMENDED FOR EVERY 3 MONTHS CONTINUOUS OPERATION WITHOUT ANY BATTERY DISCHARGE.
- WARRANTY VOID IF SERIAL NO.PLATE IS DAMAGED.

 **CAUTION**

- CONFIRM UPS IS ON BYPASS MODE BEFORE CLOSE Q2. FOR MORE DETAILS PLEASE REFER TO THE USER MANUAL.
- PRESS THE "OFF" BUTTON ON POWER MODULE BEFORE PULL OUT IT. DO NOT REMOVE MODULE'S COVER UNTIL 10 MINUTES AFTER IT IS PULLED OUT.
- CONFIRM UPS IS ON MAINTENANCE MODE OR POWER OFF BEFORE MAINTENANCE.



DANGER

- RISK OF ELECTRIC SHOCK.
- DO NOT TOUCH UNINSULATED BATTERY TERMINAL.
- TEST BEFORE TOUCHING.
- DISCONNECTION OF THE EXTERNAL AC & DC SWITCHES IS REQUIRED FOR COMPLETE LOAD POWER OFF OR MAINTENANCE.



**SEE THE WIRING
DIAGRAM ON THE FRONT
DOOR BEFORE INSTALLATION.**



Mind your hand!



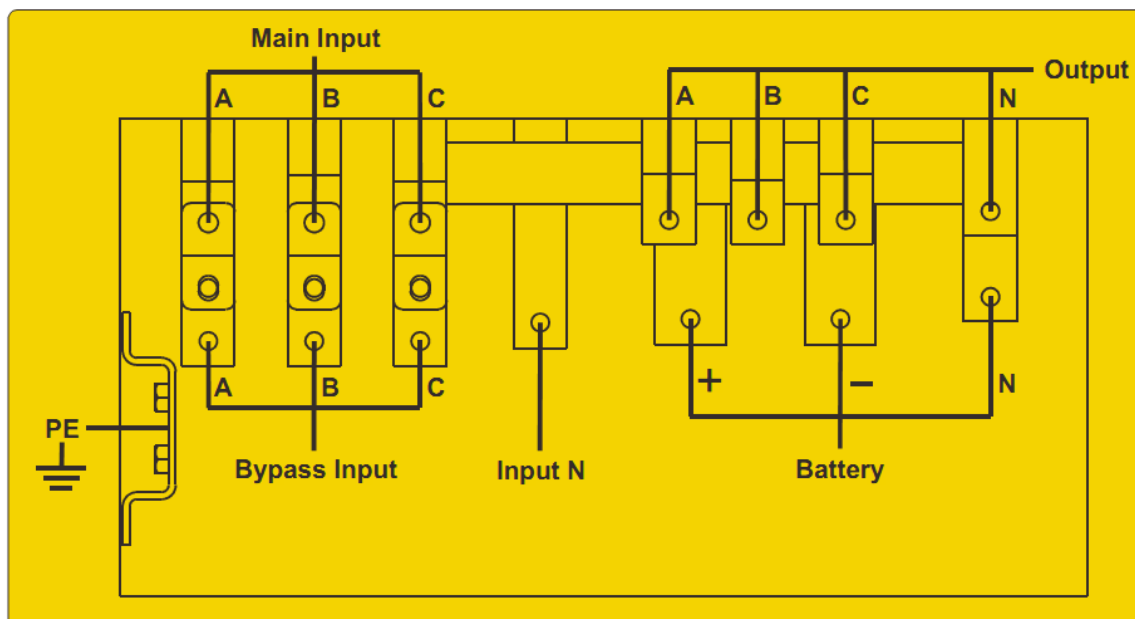

18. Warning label on outer enclosures for HT33240X, HT33250X, HT33300X.

**WARNING**

**CHARGED CAPACITORS
DISCHARGE TIME 5 MINUTES AFTER
DISCONNECTION OF UPS AND BATTERY.**

**CAUTION**

- HIGH LEAKAGE CURRENT, EARTH CONNECTION ESSENTIAL BEFORE CONNECTING UPS.
- DO NOT REMOVE COVERS. THIS SYSTEM IS TO BE SERVICED BY QUALIFIED SERVICE PERSONNEL ONLY.
- HAZARDOUS LIVE PARTS INSIDE THIS UPS ARE ENERGIZED FROM THE BATTERY SUPPLY EVEN WHEN THE AC INPUT POWER IS DISCONNECTED.
- SEE USER MANUAL FOR INSTALLATION, OPERATING AND MAINTENANCE INSTRUCTIONS.

OPERATION INSTRUCTION

- BATTERY VOLTAGE&CONNECTION MUST COMPLY WITH UPS SPECIFICATION.
- MANUAL BATTERY DISCHARGE RECOMMENDED FOR EVERY 3 MONTHS CONTINUOUS OPERATION WITHOUT ANY BATTERY DISCHARGE.
- WARRANTY VOID IF SERIAL NO.PLATE IS DAMAGED.

**CAUTION**

- CONFIRM UPS IS ON BYPASS MODE BEFORE CLOSE Q2. FOR MORE DETAILS PLEASE REFER TO THE USER MANUAL.
- PRESS THE "OFF" BUTTON ON POWER MODULE BEFORE PULL OUT IT. DO NOT REMOVE MODULE'S COVER UNTIL 10 MINUTES AFTER IT IS PULLED OUT.
- CONFIRM UPS IS ON MAINTENANCE MODE OR POWER OFF BEFORE MAINTENANCE.



DANGER

- RISK OF ELECTRIC SHOCK.
- DO NOT TOUCH UNINSULATED BATTERY TERMINAL.
- TEST BEFORE TOUCHING.
- DISCONNECTION OF THE EXTERNAL AC & DC SWITCHES IS REQUIRED FOR COMPLETE LOAD POWER OFF OR MAINTENANCE.



SEE THE WIRING
DIAGRAM ON THE FRONT
DOOR BEFORE INSTALLATION.



Mind your hand!



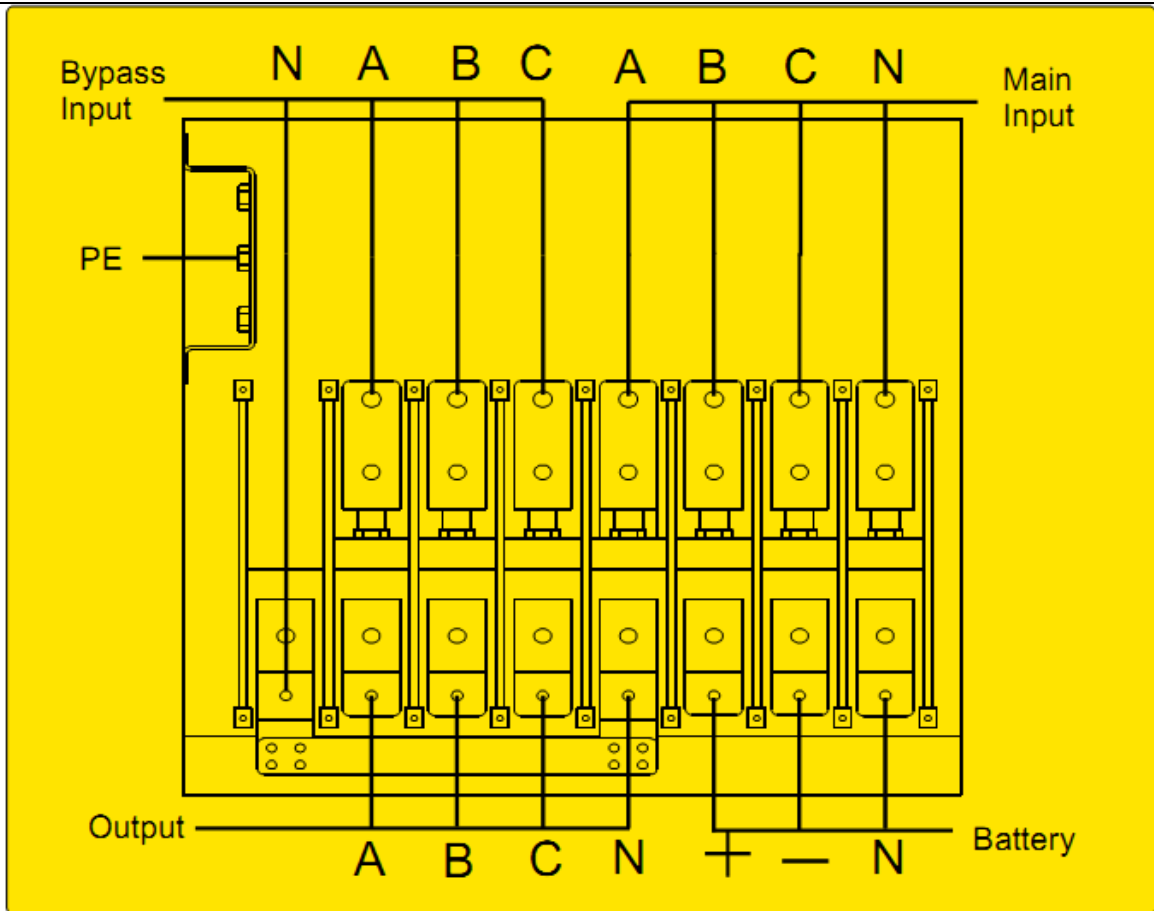

19. Warning label on outer enclosures for HT33320X, HT33360X, HT33400X, HT33450X, RM500/50X.

Before pulling out the STS unit, ensure that the UPS has been turned off or on maintenance mode, the cables connecting to STS unit have been removed, and the screws connecting between the STS unit and related copper bars have been removed.

Please refer to the operation manual.

Before pulling out the monitor unit, ensure that the UPS has been turned off or on maintenance mode, and the cables connecting to monitor unit have been removed.

Please refer to the operation manual.



**CTRL
N**



CAUTION

- CONFIRM UPS IS ON BYPASS MODE BEFORE CLOSE Q2. FOR MORE DETAILS PLEASE REFER TO THE USER MANUAL.
- PRESS THE "OFF" BUTTON ON POWER MODULE BEFORE PULL OUT IT. DO NOT REMOVE MODULE'S COVER UNTIL 10 MINUTES AFTER IT IS PULLED OUT.
- CONFIRM UPS IS ON MAINTENANCE MODE OR POWER OFF MODE BEFORE PULL OUT THE MONITORING MODULE.

 **WARNING**

CHARGED CAPACITORS
DISCHARGE TIME 5 MINUTES AFTER
DISCONNECTION OF UPS AND BATTERY.

 **CAUTION**

- HIGH LEAKAGE CURRENT, EARTH CONNECTION ESSENTIAL BEFORE CONNECTING UPS.
- DO NOT REMOVE COVERS. THIS SYSTEM IS TO BE SERVICED BY QUALIFIED SERVICE PERSONNEL ONLY.
- HAZARDOUS LIVE PARTS INSIDE THIS UPS ARE ENERGIZED FROM THE BATTERY SUPPLY EVEN WHEN THE AC INPUT POWER IS DISCONNECTED.
- SEE USER MANUAL FOR INSTALLATION, OPERATING AND MAINTENANCE INSTRUCTIONS.

OPERATION INSTRUCTION

- BATTERY VOLTAGE&CONNECTION MUST COMPLY WITH UPS SPECIFICATION.
- MANUAL BATTERY DISCHARGE RECOMMENDED FOR EVERY 3 MONTHS CONTINUOUS OPERATION WITHOUT ANY BATTERY DISCHARGE.
- WARRANTY VOID IF SERIAL NO.PLATE IS DAMAGED.

 **DANGER**

- RISK OF ELECTRIC SHOCK.
- DO NOT TOUCH UNINSULATED BATTERY TERMINAL.
- TEST BEFORE TOUCHING.
- DISCONNECTION OF THE EXTERNAL AC & DC SWITCHES IS REQUIRED FOR COMPLETE LOAD POWER OFF OR MAINTENANCE.



Test item particulars:	
Equipment mobility	<input type="checkbox"/> movable <input checked="" type="checkbox"/> stationary <input type="checkbox"/> for building-in
Connection to the mains.....	<input type="checkbox"/> pluggable equipment <input checked="" type="checkbox"/> permanent connection <input type="checkbox"/> detachable power supply cord <input type="checkbox"/> non-detachable power supply cord
Operating condition	<input checked="" type="checkbox"/> continuous <input type="checkbox"/> rated operating / resting time:
Access location	<input checked="" type="checkbox"/> operator accessible <input type="checkbox"/> restricted access location
Over voltage category (OVC)	<input type="checkbox"/> OVC I <input checked="" type="checkbox"/> OVC II <input type="checkbox"/> OVC III <input type="checkbox"/> OVC IV <input type="checkbox"/> other
Mains supply tolerance (%) or absolute mains supply values	380Vac(-10%), 415Vac(+10%) of input voltage considered
Tested for IT power systems	<input type="checkbox"/> Yes <input checked="" type="checkbox"/> No
IT testing, phase-phase voltage (V)	NA
Class of equipment	<input checked="" type="checkbox"/> Class I <input type="checkbox"/> Class II <input type="checkbox"/> Not classified
Considered current rating (A)	720A
Pollution degree (PD)	<input type="checkbox"/> PD 1 <input checked="" type="checkbox"/> PD 2 <input type="checkbox"/> PD 3
IP protection class	IP20
Altitude during operation (m)	Up to 2000
Altitude of test laboratory (m)	below 2000
Mass of equipment (kg)	900Kg
Possible test case verdicts:	
- test case does not apply to the test object	N
- test object does meet the requirement	P (Pass)
- test object does not meet the requirement	F (Fail)
Testing:	
Date of receipt of test item.....	August 01, 2016
Date(s) of performance of tests.....	August 01, 2016 to August 31, 2015
General remarks:	
<p>The test results presented in this report relate only to the object tested. This report shall not be reproduced, except in full, without the written approval of the Issuing testing laboratory. "(see Enclosure #)" refers to additional information appended to the report. "(see appended table)" refers to a table appended to the report.</p> <p>Throughout this report a comma (point) is used as the decimal separator. Standard IEC/EN 62040-1:2008+A1:2013 is to be used in conjunction with EN 60950-1:2006, which is referred to in this TRF as "RD".</p>	
General product information:	
<p>This report is amended from previous report ES160617014S, issued on September 30, 2016, due to below amendments:</p> <p>- Changed Type name: RM080/40X, RM100/50X, RM120/40X, RM150/50X, RM160/40X, RM200/50X, RM240/40X, RM250/50X, RM300/50X, RM320/40X, RM360/40X, RM400/40X, RM450/50X, RM500/50X, RM400/50X, which is identical to original model except for model name. No test needed to consider.</p>	

1. The equipment is on line type uninterruptible power supplies with sine wave o/p for general use. The UPS is also designed for IT power system where phase to phase voltage is 380/400/415V in the installation manual, disconnect devices are required to be installed on Neutral and 3 different phases for IT power system.

External battery cabinet is optional and not provided with the UPS. 120Ah external battery cabinet used during testing.

2. Model difference description:

All models are designed with same control logic, constructions, PCB Layout except for the quantity of UPS module, model name and ratings. All tests were performed on model RM500/50X which means the typical model.

The maximum operating temperature is 40°C.

IEC 62040-1			
Clause	Requirement + Test	Result - Remark	Verdict

4	GENERAL CONDITIONS FOR TESTS		P
---	------------------------------	--	---

4.5	Components		P
	Comply with IEC 62040-1 or relevant component standard	(see appended table 4.5)	P
1.5.2/RD	Evaluation and testing of components		N
1.5.3/RD	Thermal controls	No thermal control.	P
1.5.4/RD	Transformers	T1 PS1203_MN1 board	P
1.5.5/RD	Interconnecting cables		N
1.5.6/RD	Capacitors bridging insulation	IEC 60384-14 certified X-Y capacitors used	P
1.5.7/RD	Resistors bridging insulation		N
1.5.7.1/RD	Resistors bridging functional, basic or supplementary insulation		N
1.5.7.2/RD	Resistors bridging double or reinforced insulation between a.c. mains and other circuits	No resistors bridging double or reinforced insulation.	N
1.5.7.3/RD	Resistors bridging double or reinforced insulation between a.c. mains and antenna or coaxial cable	No bridging resistors	N
1.5.8/RD	Components in equipment for IT power systems		N

4.6	Power interface		P
1.6.1/RD	AC power distribution systems	TN power system	P
1.6.2/RD	Input current	(see appended table 4.6)	P
4.6 1.6.4/RD	Neutral conductor	Neutral is insulated from earth with basic insulation throughout the equipment. O/P neutral is not isolated from I/P neutral.	P

4.7	Marking and instructions		P
4.7.1	General		P
4.7.2 1.7.1/RD	Power rating	The required marking is located on the outside surface of the equipment.	P
	Input rated voltage/range (V).....:	380/400/415Vac	P
	Input rated current/range (A).....:	See rating label	P
	Input symbol for nature of supply (d.c.)	240VDC (battery input)	N
	Input rated frequency/range (Hz)	50 / 60Hz	P
	Number of Input phases and neutral	3phases + neutral	P
	Output rated voltage/range (V)	380/400/415Vac	P

IEC 62040-1			
Clause	Requirement + Test	Result - Remark	Verdict
	Output rated current/range (A)	See rating label	P
	Output rated power factor, (if less than unity, or active power and apparent power or active power and rated current)	Power factor: 0.9	P
	Number of output phases and neutral	3phases + neutral	P
	Output rated active power (W)	See rating label	P
	Output rated apparent power (VA)	See rating label	P
	Output symbol for nature of supply (d.c.)	No d.c. output.	N
	Output rated frequency/range (Hz).....	See rating label	P
	Ambient operating temperature range (°C)	Not shown (40°C declared by the client)	P
	Rated short-time withstand current (I _{cw}) or rated conditional short-circuit current (I _{cc})	See rating label	P
	Manufacturer's name or trademark or identification mark	INVT	P
	Type/model or type reference	See rating label	P
	Symbol for Class II equipment only	The equipment is Class I.	N
	Other symbols	The additional marking does not give rise to misunderstandings.	P
	Certification marks	CE	P
	Instructions for units with automatic bypass / maintenance bypass, additional input a.c. supply, or external batteries, having text "See installation instructions before connecting to the supply"	Instruction provided. See copy of marking plate	P
4.7.3	Safety instructions	See below	P
4.7.3.1	General	<p>"User manual" with directions regarding the maximum ambient temperature, electrical ratings, operation, description of interfaces, connection to the mains.</p> <p>Service personnel installable and to be operated by laymen.</p> <p>Appropriate statements provided in the "User Manual".</p>	P
4.7.3.2	Installation	Installation instructions are available to the user in User's Manual.	P
	Location in a restricted access location only		N
	Permanent connector UPS.....	Installation person and disconnect device instructions are available to the user in User's Manual.	P

IEC 62040-1			
Clause	Requirement + Test	Result - Remark	Verdict
	Pluggable type A or Pluggable type B UPS		N
4.7.3.3	Operation	The suitable information list in the user manual when operate the UPS. Not for restricted access location.	P
4.7.3.4	Maintenance	The instruction of maintenance is only included in the service manual.	P
4.7.3.5	Distribution related backfeed		N
4.7.4 1.7.4/RD	Main voltage adjustment	No voltage selector	N
	Methods and means of adjustment; reference to installation instructions	No voltage selector	N
4.7.5 1.7.5/RD	Power outlets		N
4.7.6 1.7.6/RD	Fuse identification (marking, special fusing characteristics, cross-reference)	All fuses and circuit breakers are not located in operator accessible area. Fuse rating placed on the relevant PCB layout and metal enclosure which is nearby the fuse body. Fuse identifications for internal use and other detailed information.	P
4.7.7 1.7.7/RD	Wiring terminals	Refer below:	P
1.7.7.1/RD	Protective earthing and bonding terminals	The earthing terminal is marked with the standard earthing symbol (60417-2-IEC-5019) near the terminal. 	P
1.7.7.2/RD	Terminals for a.c. mains supply conductors	non-detachable power supply cord	P
1.7.7.3/RD	Terminals for d.c. mains supply conductors		P
4.7.8	Battery terminals :	The terminal of batteries is marked with standard symbol (IEC 60417, No. 5005 and No. 5006).	P
4.7.9 1.7.8/RD	Controls and indicators	See below	P
1.7.8.1/RD	Identification, location and marking :	LCD display provided, located on the front panel for functional purpose only.	P
1.7.8.2/RD	Colours	See above. Colours are acceptable due to used for information only (no safety involved even if disregarded).	P

IEC 62040-1			
Clause	Requirement + Test	Result - Remark	Verdict
1.7.8.3/RD	Symbols		N
1.7.8.4/RD	Markings using figures :	No controls affecting safety are using figures.	N
4.7.10 1.7.9/RD	Isolation of multiple power sources :	Different connecting method for AC mains and external battery cabinet used, not likely to misconnect. Disconnecting all input (mains connection and battery input) is specified in caution label and user manual.	P
4.7.11 1.7.2.4/RD	IT power systems	TN power system.	N
4.7.12	Protection in building installation	The protection does rely upon building installation.	P
	Rated short-time withstand current (I_{cw})		N
	Rated conditional short circuit current (I_{cc})		N
	a) If higher I_{cp} stated ≤ 10 kA		N
	a) If higher I_{cp} stated > 10 kA		N
4.7.13 5.1/RD	High leakage current (mA)	Leakage current of the equipment does not exceed 3.5mA. However due to the connected load has influence on the overall earth leakage current, a corresponding statement was provided in the User's Manual.	P
4.7.14 1.7.10/RD	Thermostats and other regulating devices	No thermostats or other regulating devices.	N
4.7.15 1.7.2.1/RD and 1.7.8.1/RD	Language(s)	Instructions and markings shall be in a language acceptable for the country where the equipment is to be used. English user manual provided.	P
4.7.16 1.7.11/RD	Durability of markings	The label was subjected to the permanence of marking test. The label was rubbed with cloth soaked with water for 15s and then again for 15s with the cloth soaked with petroleum spirit. After this test there was no damage to the label. The marking of the label did not fade. There was neither curling nor lifting of the label edge.	P
4.7.17 1.7.12/RD	Removable parts	No required markings placed on removable parts.	P

IEC 62040-1			
Clause	Requirement + Test	Result - Remark	Verdict
4.7.18 1.7.13/RD	Replaceable batteries	The battery is not placed in an operator access area. The required warning is in the safety manual.	P
	Language(s)	Instructions and markings are in English.	P
4.7.19 1.7.2.5/RD	Operator access with a tool.....:	Operator is not instructed to use a tool in order to gain access to operator access area.	N
4.7.20	Battery	Permanent connection, UPS with integral batteries.	P
	Clearly legible information	Warning label attached on the outside surface of External battery pack. Information clearly legible	P
	Battery type (lead-acid, NiCd, etc.) and number of blocks or cells	Detailed information regarding to the battery used will be provided in the instruction manual	P
	Nominal voltage of total battery (V)	240Vdc	P
	Nominal capacity of total battery (optional)	Stated on rating user's manual.	N
	Warning label	considered	P
	Instructions	The sufficient information about the battery was given in the user's manual.	P
2.1.1.5/RD	Protection against energy hazards	No energy hazard in operator access area. Checked by means of the test finger.	P
4.7.21 1.7.2.4/RD	Installation instructions	Detailed information regarding external interfaces of supply and loads provided in the user's manual.	P

5	FUNDAMENTAL DESIGN REQUIREMENTS		P
5.1	Protection against electric shock and energy hazards		P
5.1.1 2.1.1/RD	Protection for UPS intended to be used in operator access areas	No hazardous voltage circuit wiring can be accessed by operator.	P

IEC 62040-1			
Clause	Requirement + Test	Result - Remark	Verdict
2.1.1.1/RD	Access to energized parts	There is adequate protection against operator contact with bare parts at ELV or hazardous voltage or parts separated from these with basic or functional insulation only (except protective earth). No hazardous voltages exceeding 1000V a.c. or 1500V d.c. Checked by test finger, test probe and test pin.	P
	Test by inspection :		P
	Test with test finger (Figure 2A) :	Not accessible	P
	Test with test pin (Figure 2B) :	Not accessible	P
	Test with test probe (Figure 2C) :	No TNV circuits	N
2.1.1.2/RD	Battery compartments	No TNV circuits exist inside battery compartments	N
2.1.1.3/RD	Access to ELV wiring	No ELV wiring in operator accessible area due to the parallel connection ports are covered by metal during normal use.	N
	Working voltage (V_{peak} or V_{rms}); minimum distance through insulation (mm)		N
2.1.1.4/RD	Access to hazardous voltage circuit wiring	All accessible parts are separated from internal wiring at hazardous voltage by double or reinforced insulation.	P
2.1.1.5/RD	Energy hazards :	No energy hazard at operator accessible area. No energy hazard during battery replacement for service person due to shape of battery terminals.	P
2.1.1.6/RD	Manual controls	Operator only has access to bare parts of SELV circuits.	N
2.1.1.7/RD	Discharge of capacitors in equipment	The capacitance of the input circuits $> 0.1 \mu F$, refer to list of critical components.	P
	Measured voltage (V); time-constant (s) :	(See appended table 5.1.1)	P
2.1.1.8/RD	Energy hazards – d.c. mains supply	The equipment is not connected to d.c. mains supply	N
	a) Capacitor connected to the d.c. mains supply :		N
	b) Internal battery connected to the d.c. mains supply :		N

IEC 62040-1			
Clause	Requirement + Test	Result - Remark	Verdict
2.1.1.9/RD	Audio amplifiers in information technology equipment ::	No such parts.	N
5.1.2 2.1.1.5 c) /RD	Protection for UPS intended to be used in service access areas	Checked by inspection, unintentional contact is unlikely during service operations.	N
	Hazardous energy level		N
5.1.3 2.1.1.5 c) /RD	Protection for UPS intended to be used in restricted access areas	Not for restricted access area	N
	Hazardous energy level		N
5.1.4	Backfeed protection		--
	Shock hazard after de-energization of a.c. input for UPS		N
	Measured voltage (V); time-constant (s) :		N
	Description of the construction :		N
	Air gap is employed for backfeed protection		N
5.1.5	Emergency switching device	Permanent connection, no emergency switching device for the load required.	P

5.2	Requirements for auxiliary circuits		P
5.2.1 2.2/RD	Safety extra low voltage circuit - SELV	USB, RS232, RS485 are considered as SELV circuit.	P
2.2.1/RD	General requirements	All SELV circuits within limits.	P
2.2.2/RD	Voltages under normal conditions (V)	Within SELV limits. (See appended table 5.2.1)	P
2.2.3/RD	Voltages under fault conditions (V)	Within SELV limits. (See appended table 5.2.1)	P
2.2.4/RD	Connection of SELV circuits to other circuits ..	SELV circuits are only connected to other SELV and protective earth.	P
5.2.2 2.3/RD	Telephone network voltage circuits - TNV	Refer below:	N
2.3.1/RD	Limits	No TNV circuits, cl. 2.3/RD	N
	Type of TNV circuits :		--
2.3.2/RD	Separation from other circuits and from accessible parts		N
2.3.2.1/RD	General requirements		N
2.3.2.2/RD	Protection by basic insulation		N
2.3.2.3/RD	Protection by earthing		N
2.3.2.4/RD	Protection by other constructions :		N
2.3.3/RD	Separation from hazardous voltages		N

IEC 62040-1			
Clause	Requirement + Test	Result - Remark	Verdict
	Insulation employed :		--
2.3.4/RD	Connection of TNV circuits to other circuits		N
	Insulation employed :		N
2.3.5/RD	Test for operating voltages generated externally		N
5.2.3 2.4/RD	Limited current circuits	No limited current circuits, cl. 2.4/RD.	N
2.4.1/RD	General requirements		N
2.4.2/RD	Limit values		N
	Frequency (Hz) :		N
	Measured current (mA) :		N
	Measured voltage (V) :		N
	Measured circuit capacitance (nF or μ F) :		N
2.4.3/RD	Connection of limited current circuits to other circuits		N
5.2.4 3.5/RD	External signalling circuits	RS485, USB, RS232 are considered as SELV	P
3.5.1/RD	General requirements		N
3.5.2/RD	Types of interconnection circuits :		N
3.5.3/RD	ELV circuits as interconnection circuits	No ELV interconnections.	N
3.5.4/RD	Data ports for additional equipment		N
5.2.5 2.5/RD	Limited power source		N
	a) Inherently limited output		N
	b) Impedance limited output		N
	c) Regulating network limited output under normal operating and single fault condition		N
	d) Overcurrent protective device limited output		N
	Max. output voltage (V), max. output current (A), max. apparent power (VA)		N
	Current rating of overcurrent protective device (A)		N
	Use of integrated circuit (IC) current limiters		N

5.3	Protective earthing and bonding		P
5.3.1	General		P
2.6/RD	Provisions for earthing and bonding	See below.	P
2.6.1/RD	Protective earthing	Reliable connection of relevant conductive parts to the PE terminal (via green/yellow insulated wires).	P

IEC 62040-1			
Clause	Requirement + Test	Result - Remark	Verdict
2.6.2/RD	Functional earthing	Functional earthing on PCB board is separated by basic insulation from primary circuit.	P
2.6.3/RD	Protective earthing and protective bonding conductors	See below.	P
2.6.3.1/RD	General	See subclause 2.6.3.3	P
2.6.3.2/RD	Size of protective earthing conductors		P
	Rated current (A), cross-sectional area (mm ²), AWG :	(see appended tabel 4.5)	P
2.6.3.3/RD	Size of protective bonding conductors	Refer to 2.6.3.4/RD.	P
	Rated current (A), cross-sectional area (mm ²), AWG :	Refer to 2.6.3.4/RD.	P
	Protective current rating (A), cross-sectional area (mm ²), AWG :	Refer to 2.6.3.4/RD.	P
2.6.3.4/RD	Resistance of earthing conductors and their terminations; resistance (Ω), voltage drop (V), test current (A), duration (min) :	(See appended table 5.3.1)	P
2.6.3.5/RD	Colour of insulation :	All insulated protective earth conductors are used colored green and yellow.	P
2.6.4/RD	Terminals	Green/yellow wire form metal chassis to the RECEPTACLE Board and SURGE Board.	P
2.6.4.1/RD	General	See below.	P
2.6.4.2/RD	Protective earthing and bonding terminals	Adequate protective earth connection, see also Sub-clause 2.6.3.4/RD and 3.3/RD	P
	Rated current (A), type, nominal thread diameter (mm) :		P
2.6.4.3/RD	Separation of the protective earthing conductor from protective bonding conductors	Protective bonding conductor is used form the input terminal to the metal chassis, separate bonding terminal used to connect the bonding conductor between different output terminals and metal frame of the UPS.	P
2.6.5/RD	Integrity of protective earthing	See below.	P
2.6.5.1/RD	Interconnection of equipment	This unit has its own earthing connection. PE terminals of outlets and earth bonding terminal reliably connected to PE terminal of unit	P

IEC 62040-1			
Clause	Requirement + Test	Result - Remark	Verdict
2.6.5.2/RD	Components in protective earthing conductors and protective bonding conductors	There are no switches or overcurrent protective devices in the protective earthing / bonding conductors.	P
2.6.5.3/RD	Disconnection of protective earth	Permanently equipment no disconnection	P
2.6.5.4/RD	Parts that can be removed by an operator	Permanent connection, no parts can be removed by operator.	P
2.6.5.5/RD	Parts removed during servicing	It is not necessary to disconnect earthing except for the removal of the earthed part itself.	P
2.6.5.6/RD	Corrosion resistance	All safety earthing connections in compliance with Annex J.	P
2.6.5.7/RD	Screws for protective bonding	Protective bonding conductors connected to metal chassis via ring-type lugs fixed to metal bolts (ISO thread type M4), with nut and star-washer provided.	P
2.6.5.8/RD	Reliance on telecommunication network or cable distribution system	Protective earthing is not rely on cable distribution system.	N
5.3.2 2.6.1/RD	Protective earthing	Accessible conductive parts are reliably connected to protective earth terminal	P
2.10/RD	Clearances, creepage distances and distances through insulation	See clause 5.7	P
4.2/RD	Mechanical strength	See clause 7.3	P
5.2/RD	Electric strength	See clause 8.2	P
5.3.3	Protective bonding	Refer also to 2.6.3.4/RD	P

5.4	AC and d.c. power isolation		P
5.4.1	General	See below	P
3.4/RD	Disconnection from the mains supply		P
3.4.1/RD	General requirement		P
3.4.2/RD	Disconnect devices	For permanent connection type, according to installation instruction, suitable circuit breaker external to the UPS will be installed as disconnect device.	P
3.4.3/RD	Permanently connected equipment	External disconnect should be provide.	P

IEC 62040-1			
Clause	Requirement + Test	Result - Remark	Verdict
3.4.4/RD	Parts which remain energized	Adequate protection provided to service personnel during backup and maintenance mode.	P
3.4.5/RD	Switches in flexible cords	No such construction.	N
3.4.6/RD	Number of poles - single-phase and d.c. equipment	Three phase equipment	P
3.4.7/RD	Number of poles - three-phase equipment	3 pole switch will be used as disconnected device for whole system and it is optional to the UPS, Adequate disconnection information regarding the disconnection switch for the configuration without the integrated disconnection switch for whole unit was already stated in the final installation.	P
3.4.8/RD	Switches as disconnect devices	Relevant indication provided on the body of disconnection switch	P
3.4.9/RD	Plugs as disconnect devices		N
3.4.10/RD	Interconnected equipment	SELV circuits connect only to SELV circuits and Hazardous Voltage circuits to Hazardous circuits.	P
3.4.11/RD	Multiple power sources	Instructions provided at every switch, see" Copies of markings and warnings".	P
5.4.2	Disconnect devices		P

5.5	Overcurrent and earth fault protection		P
5.5.1	General		P
2.7.3/RD	Short-circuit backup protection	Over current protection by built-in fuses in each of 3 phases. Permanently Connected Equipment. Building Installation is provide short-circuit backup protection.	P
2.7.4/RD	Number and location of protective devices	Over current protector provided in live conductor	P
2.7.5/RD	Protection by several devices	Three fuse in parallel protection device provided. No protective device in neutral.	P
2.7.6/RD	Warning to service personnel :	Only one protection device provided.	N

IEC 62040-1			
Clause	Requirement + Test	Result - Remark	Verdict
5.5.2	Basic requirements	Equipment relies on over current protector or circuit breaker of the wall outlet protection of the building installation in regard to L to N short-circuit.	P
5.5.3	Battery circuit protection	External battery cabinet is not provided with UPS. Protection shall be provided in battery cabinet.	P
5.5.3.1	Overcurrent and earth fault protection	Battery fuses are directly located behind the supply wire terminals to the external battery cabinets The charger circuit is located in front of the fuse. For the charger circuit there are no hazardous situations under any simulated fault conditions.	P
5.5.3.2	Location of protective device	See above	P
5.5.3.3	Rating of protective device	Protection against overcurrent by Fuse.	P
5.3.1/RD	Protection against overload and abnormal operation	(see appended table 8.3)	P
5.5.4	Short-time withstand current		P
5.5.4.1	General		P
5.5.4.2	Modes of operation		P
5.5.4.3	Test procedure		P
5.5.4.3.1	General application		P
	Rated UPS output current/(r.m.s) (A)	See product specification	P
	Prospective test current/(r.m.s) (A)	See product specification	P
	Typical power factor	See product specification	P
	Initial asymmetric peak current ration (I_{pk} / I_{cw}) ..	See product specification	P
	Minimum duration of prospective test current (cycles 50/60 Hz)	See product specification	P
5.5.4.3.2	Exemption from testing		P

5.6	Protection of personnel – Safety interlocks		P
5.6.1	Operator protection	No hazardous parts in operator access areas	N
2.8/RD	Safety interlocks		N
2.8.1/RD	General principles		N
2.8.2/RD	Protection requirements		N
2.8.3/RD	Inadvertent reactivation		N

IEC 62040-1			
Clause	Requirement + Test	Result - Remark	Verdict
2.8.4/RD	Fail-safe operation		N
2.8.4/RD	Protection against extreme hazard		P
2.8.5/RD	Moving parts		N
2.8.6/RD	Overriding		N
2.8.7/RD	Switches, relays and their related circuits		N
2.8.7.1/RD	Separation distances for contact gaps and their related circuits :		N
2.8.7.2/RD	Overload test		N
2.8.7.3/RD	Endurance test		N
2.8.7.4/RD	Electric strength test		N
2.8.8/RD	Mechanical actuators		N
5.6.2	Service person protection		P
5.6.2.1	Introduction		P
5.6.2.2	Covers		N
5.6.2.3	Location and guarding of parts		N
5.6.2.4	Parts on doors	No such parts.	N
5.6.2.5	Component access	No hazard likely when access breakers	N
2.8.3/RD	Fail-safe operation		N
5.6.2.6	Moving parts		N
5.6.2.7	Capacitor banks		P
5.6.2.8	Internal batteries		P

5.7 2.10/RD	Clearances, creepage distances and distances through insulation		P
2.10.1/RD	General	See 2.10.3/RD, 2.10.4/RD and 2.10.5/RD.	P
2.10.1.1/RD	Frequency	Considered.	P
2.10.1.2/RD	Pollution degrees	II	P
2.10.1.3/RD	Reduced values for functional insulation	See clause 2.6.2/RD	P
2.10.1.4/RD	Intervening unconnected conductive parts	No such part.	P
2.10.1.5/RD	Insulation with varying dimensions	No such transformer used.	N
2.10.1.6/RD	Special separation requirements	No TNV	N
2.10.1.7/RD	Insulation in circuits generating starting pulses	No such circuit generating starting pulses.	N
2.10.2/RD	Determination of working voltage	(See appended table 5.7)	P
2.10.2.1/RD	General	See below.	P
2.10.2.2/RD	RMS working voltage	(See appended table 5.7)	P
2.10.2.3/RD	Peak working voltage	(See appended table 5.7)	P

IEC 62040-1			
Clause	Requirement + Test	Result - Remark	Verdict
2.10.3/RD	Clearances	See below. Annex G/RD was not considered.	P
2.10.3.1/RD	General	Annex F/RD and minimum clearances considered.	P
2.10.3.2/RD	Mains transient voltages	See below.	P
	a) AC mains supply	Equipment is Overvoltage Category II.	P
	b) Earthed d.c. mains supplies		N
	c) Unearthed d.c. mains supplies :		N
	d) Battery operation :	Dedicated battery used.	P
2.10.3.3/RD	Clearances in primary circuits	(see appended table 5.7)	P
2.10.3.4/RD	Clearances in secondary circuits	Sub-clause 5.3.4 considered.	P
2.10.3.5/RD	Clearances in circuits having starting pulses	No such circuit generating starting pulses.	N
2.10.3.6/RD	Transients from a.c. mains supply :	Normal transient voltage considered (overvoltage category II for primary circuit).	N
2.10.3.7/RD	Transients from d.c. mains supply :		N
2.10.3.8/RD	Transients from telecommunication networks and cable distribution systems :		N
2.10.3.9/RD	Measurement of transient voltage levels		N
	a) Transients from a mains supply		N
	For an a.c. mains supply :		N
	For a d.c. mains supply :		N
	b) Transients from a telecommunication network :		N
2.10.4/RD	Creepage distances	(see appended table 5.7)	P
2.10.4.1/RD	General	See below.	P
2.10.4.2/RD	Material group and comparative tracking index	Material IIIb is used.	P
	CTI tests	(see appended table 5.7 and 2.10.4/RD)	P
2.10.4.3/RD	Minimum creepage distances	(see appended table 5.7)	P
2.10.5 /RD	Solid insulation		P
2.10.5.1/RD	General		P
2.10.5.2/RD	Distances through insulation		P
2.10.5.3/RD	Insulating compound as solid insulation	Approved opto-couplers, see appended table 4.5	P
2.10.5.4/RD	Semiconductor devices		N
2.10.5.5/RD	Cemented joints		P

IEC 62040-1			
Clause	Requirement + Test	Result - Remark	Verdict
2.10.5.6/RD	Thin sheet material – General	Insulation tape provided in isolation transformers: T1 transformer on PS1203_MN1 board	P
2.10.5.7/RD	Separable thin sheet material	Insulation tape	P
	Number of layers (pcs).	2 or 3 layers	--
2.10.5.8/RD	Non-separable thin sheet material	Not used.	N
2.10.5.9/RD	Thin sheet material – standard test procedure		P
2.10.5.10 /RD	Thin sheet material – (Alternative) test procedure		P
	Electric strength test	(see appended table 8.2)	P
2.10.5.11 /RD	Insulation in wound components	See cl. 2.10.5.12/RD	P
2.10.5.12 /RD	Wire in wound components		P
	Working voltage :	(See appended table 5.7)	P
	a) Basic insulation not under stress :		N
	b) Basic, supplementary, reinforced insulation :		N
	c) Compliance with Annex U :		N
	Two wires in contact inside wound component; angle between 45° and 90° :		N
2.10.5.13 /RD	Wire with solvent-based enamel in wound components	No wire with solvent-based enamel in wound components.	N
	Electric strength test	(see appended table 8.2)	N
	Routine test		N
2.10.5.14 /RD	Additional insulation in wound components	No additional insulation used.	N
	Working voltage :		N
	- Basic insulation not under stress :		N
	- Supplementary, reinforced insulation :		N
2.10.6/RD	Construction of printed boards	See below.	P
2.10.6.1/RD	Uncoated printed boards	(see appended table 5.7)	P
2.10.6.2/RD	Coated printed boards		N
2.10.6.3/RD	Insulation between conductors on the same inner surface of a printed board		P
2.10.6.4/RD	Insulation between conductors on different layers of a printed board	(see appended table 5.7 and 2.10.3/RD)	P
	Distance through insulation		P
	Number of insulation layers (pcs) :	4	P
2.10.7/RD	Component external terminations		N

IEC 62040-1			
Clause	Requirement + Test	Result - Remark	Verdict
2.10.8/RD	Tests on coated printed boards and coated components	No such part.	N
2.10.8.1/RD	Sample preparation and preliminary inspection		N
2.10.8.2/RD	Thermal conditioning		N
2.10.8.3/RD	Electric strength test		N
2.10.8.4/RD	Abrasion resistance test		N
2.10.9/RD	Thermal cycling		P
2.10.10/RD	Test for Pollution Degree 1 environment and insulating compound		N
2.10.11/RD	Tests for semiconductor devices and cemented joints		P
2.10.12/RD	Enclosed and sealed parts		N

6	Wiring, connections and supply		P
6.1	General		P
6.1.1	Introduction		P
3.1/RD	General		P
3.1.1/RD	Current rating and overcurrent protection	All internal wires are UL recognized wiring which is PVC insulated Internal wiring gauge is suitable for current intended to be carried. Internal wiring for primary power distribution protected against overcurrent by built-in circuit-breaker.	P
3.1.2/RD	Protection against mechanical damage	Wireways are smooth and free from edges. Wires are adequately fixed to prevent excessive strain on wire and terminals and avoiding damage to the insulation of the conductors.	P
3.1.3/RD	Securing of internal wiring	Internal wiring is secured against excessive strain, loosening of terminals and damage to the conductor insulation.	P
3.1.4/RD	Insulation of conductors	Insulation on internal conductors is considered to be of adequate quality and suitable for the application and the working voltage involved.	P
3.1.5/RD	Beads and ceramic insulators	No beads or similar ceramic insulators on conductors.	N
3.1.6/RD	Screws for electrical contact pressure		P

IEC 62040-1			
Clause	Requirement + Test	Result - Remark	Verdict
3.1.7/RD	Insulating materials in electrical connections	All current carrying and safety earthing connections are metal to metal.	P
3.1.8/RD	Self-tapping and spaced thread screws	No self- tapping or spaced thread screws used for connection of current-carrying parts.	P
3.1.9/RD	Termination of conductors	All conductors are reliable secured by the use of solder pins or glue or other mechanical fixing means. No risk of stranded conductors coming loose.	P
	10 N pull test	Break away or pivot on its terminal is unlikely.	P
3.1.10/RD	Sleeving on wiring	Sleeving used to provide supplementary/ reinforce insulation.	P
6.1.2	Dimensions and rating of busbars and insulated conductors		N

6.2	Connection to power		P
6.2.1	General provisions for connection to power		P
3.2.2/RD	Multiple supply connections	Terminals for permanent connection	P
3.2.3/RD	Permanently connected equipment	For permanent connection type, terminals for permanent connection to supply.	P
	Number of conductors, diameter of cable and conduits (mm)		--
3.2.4/RD	Appliance inlets		N
3.2.5/RD	Power supply cords	No power supply cord is supplied	N
3.2.5.1/RD	AC power supply cords		N
	Type		--
	Rated current (A), cross-sectional area (mm ²), AWG		--
3.2.5.2/RD	DC power supply cords	Not connected to DC power supply cords.	N
3.2.6/RD	Cord anchorages and strain relief		N
	Mass of equipment (kg), pull (N)		--
	Longitudinal displacement (mm)		--
3.2.7/RD	Protection against mechanical damage		P
3.2.8/RD	Cord guards		N

IEC 62040-1			
Clause	Requirement + Test	Result - Remark	Verdict

	Diameter or minor dimension D (mm); test mass (g)		--
	Radius of curvature of cord (mm).....		--
6.2.2	Means of connection :	Wiring terminal used.	P
	More than one supply connection :	AC mains and internal battery used. Connector for the battery not compatible with inlet for AC mains.	P

6.3	Wiring terminals for external power conductors <i>(No wiring terminals for external power conductors)</i>		P
3.3/RD	Wiring terminals for connection of external conductors		P
3.3.1/RD	Wiring terminals		P
3.3.2/RD	Connection of non-detachable power supply cords		N
3.3.3/RD	Screw terminals	Screws and nuts conforming to ISO 261 or ISO 262 input terminal.	P
3.3.4/RD	Conductor sizes to be connected	Conductor size will be connected according to installation manual.	P
	Rated current (A), cord/cable type, cross-sectional area (mm ²).....	For Phase/Neutral/Battery/PE conductors. See instruction manual for the configuration for all models	--
3.3.5/RD	Wiring terminal sizes		P
	Rated current (A), type, nominal thread diameter (mm)		--
3.3.6/RD	Wiring terminal design		N
3.3.7/RD	Grouping of wiring terminals		N
3.3.8/RD	Stranded wire		N

7	Physical requirements		P
7.1	Enclosure	Metal enclosure not used to carry current. Metal enclosure completely enclosing hazardous parts.	P

7.2 4.1/RD	Stability		P
---------------	-----------	--	---

IEC 62040-1			
Clause	Requirement + Test	Result - Remark	Verdict

	Angle of 10	The UPS does not overturn when: - tilted to an angle of 10° - use a constant downward force of 800N - a force of 20% of the weight is applied from any direction.	P
	Test force (N) :	See above	P

7.3 4.2/RD	Mechanical strength		P
4.2.1/RD	General	Tests performed and passed. Results see below. After the tests, unit complied with the requirements of sub-clauses 2.1.1/RD, 2.6.1/RD, 2.10/RD and 4.4.1/RD.	P
4.2.2/RD	Steady force test, 10 N	10 N applied to components.	P
4.2.3/RD	Steady force test, 30 N		N
4.2.4/RD	Steady force test, 250 N	250 N applied to outer enclosure. No energy or other hazards.	P
4.2.5/RD	Impact test	No hazard as a result from steel ball impact test.	P
	Fall test	No hazard as a result from steel ball impact test.	P
	Swing test	No hazard as result from steel sphere ball swung test.	P
4.2.6/RD	Drop test; height (mm) :		N
4.2.7/RD	Stress relief test	Metal enclosure used	P
4.2.8/RD	Cathode ray tubes	CRT(s) not used in the equipment.	N
	Picture tube separately certified :		N
4.2.9/RD	High pressure lamps	No high pressure lamps in the equipment.	N
4.2.10/RD	Wall or ceiling mounted equipment; force (N) :	No wall or ceiling mounted equipment	N

7.4	Construction details		P
7.4.1	Introduction	Considered.	P
4.3.1/RD	Edges and corners	All edges and corners are rounded and/or smoothed.	P
4.3.2/RD	Handles and manual controls; force (N)..... :	No loosening of any knobs.	N
4.3.3/RD	Adjustable controls	No hazardous adjustable controls.	N

IEC 62040-1			
Clause	Requirement + Test	Result - Remark	Verdict
4.3.4/RD	Securing of parts	No loosening of parts impairing creepage distances or clearances is likely to occur.	P
4.3.5/RD	Connection by plugs and sockets		N
4.3.7/RD	Heating elements in earthed equipment	No heating elements provided.	N
4.3.11/RD	Containers for liquids or gases	The equipment does not contain flammable liquids or gases.	N
4.4/RD	Protection against hazardous moving parts	Fan for skilled person only, cannot be touched.	P
4.4.1/RD	General	See above	P
4.4.2/RD	Protection in operator access areas :	See above	P
4.4.3/RD	Protection in restricted access locations :	See above	P
4.4.4/RD	Protection in service access areas	See above	P
4.4.5/RD	Protection against moving fan blades		N
4.4.5.1/RD	General		N
	Not considered to cause pain or injury. a) :		N
	Is considered to cause pain, not injury. b) :		N
	Considered to cause injury. c) :	Considered	P
4.4.5.2	Protection for users		N
	Use of symbol or warning :		N
4.4.5.3	Protection for service persons		N
	Use of symbol or warning :		N
4.5/RD	Thermal requirements	Considered	P
4.5.1/RD	General	See below.	P
4.5.2/RD	Temperature tests	(See appended table 7.7)	P
	Normal load condition per Annex L :		
4.5.3/RD	Temperature limits for materials	(See appended table 7.7)	P
4.5.4/RD	Touch temperature limits	(See appended table 7.7)	P
4.5.5/RD	Resistance to abnormal heat :		P
7.4.2	Openings		P
7.4.3	Gas Concentration	For the ventilation of the leadacid battery refer to table M	P
7.4.4	Equipment movement		N
7.5 4.7/RD	Resistance to fire		P
4.7.1/RD	Reducing the risk of ignition and spread of flame	Use of materials with the required flammability classes	P

IEC 62040-1			
Clause	Requirement + Test	Result - Remark	Verdict
	Method 1, selection and application of components wiring and materials	Method 1 is used. No excessive temperatures. No easily burning materials employed. Safety relevant components used within their specified temperature limits.	P
	Method 2, application of all of simulated fault condition tests		N
4.7.2/RD	Conditions for a fire enclosure	See below.	P
4.7.2.1/RD	Parts requiring a fire enclosure	With having the following components: - Components in primary circuits - Insulated wiring - Semiconductor devices, transistors, diodes, integrated circuits - Resistors, capacitors, inductors The fire enclosure is required.	P
4.7.2.2/RD	Parts not requiring a fire enclosure	The fire enclosure is required to cover all parts.	N
4.7.3/RD	Materials	See below.	P
4.7.3.1/RD	General	PCB rated V-0. See appended table.	P
4.7.3.2/RD	Materials for fire enclosures	Metal enclosure. (See appended table 4.3)	P
4.7.3.3/RD	Materials for components and other parts outside fire enclosures	See sub-clause 4.7.2/RD	N
4.7.3.4/RD	Materials for components and other parts inside fire enclosures	Internal components except small parts are V-2, HF-2 or better.	P
4.7.3.5/RD	Materials for air filter assemblies	No air filters in the equipment.	N
4.7.3.6/RD	Materials used in high-voltage components	No parts exceeding 4kV.	N

7.6	Battery location		P
7.6.1	Battery location and installation	Battery location and installation of the external battery cabinet and internal battery are described in detail.	P
7.6.2	Accessibility and maintainability		N
7.6.3	Distance	The temperature of the electrolyte and the gas emission are within the limits of this standard.	P
7.6.4	Case insulation	No Ni-Cd battery used inside.	N

IEC 62040-1			
Clause	Requirement + Test	Result - Remark	Verdict
7.6.5	Wiring	The protection of connecting wiring complies with subclause 6, details see there.	P
7.6.6	Electrolyte spillage	Sealed maintenance free battery, the emission of electrolyte is unlikely.	P
7.6.7	Ventilation	Comply with Annex M.2	P
7.6.8	Charging voltage	Protective circuit to prevent excessive charging voltages occurring under any single fault condition. See sub-clause 8.3	P

7.7	Temperature rise		P
4.5/RD	Thermal requirements	Considered	P
4.5.1/RD	General	See below.	P
4.5.2/RD	Temperature tests	(See appended table 7.7)	P
	Normal load condition per Annex L		—
4.5.3/RD	Temperature limits for materials	(See appended table 7.7)	P
4.5.4/RD	Touch temperature limits	(See appended table 7.7)	P
4.5.5/RD	Resistance to abnormal heat	(See appended table 7.4)	P
8	Electrical requirements and simulated abnormal conditions		P
8.1	General provisions for earth leakage		P
5.1.1/RD	General	Test conducted in accordance with Sub-clause 8.1	P
5.1.7/RD	Equipment with touch current exceeding 3,5 mA		P

8.2 5.2/RD	Electric strength		P
5.2.1/RD	General	(see appended table 8.2)	P
5.2.2/RD	Test procedure	(see appended table 8.2)	P

8.3	Abnormal operating and fault conditions		P
8.3.1	General	Considered.	P
5.3.1/RD	Protection against overload and abnormal operation	(See appended table 8.3)	P
5.3.2/RD	Motors		N
5.3.3/RD	Transformers	(See appended Annex C)	P
5.3.4/RD	Functional insulation :	Complies with a) and c).	P
5.3.5/RD	Electromechanical components	No electromechanical components in secondary circuits.	N

IEC 62040-1			
Clause	Requirement + Test	Result - Remark	Verdict
5.3.9/RD	Compliance criteria for abnormal operating and fault conditions	No fire or molten metal occurred and no deformation of enclosure during the tests. No reduction of clearance and creepage distances. Electric strength test is made on basic, supplementary and reinforced insulation.	P
5.3.9.1/RD	During the tests		
5.3.9.2/RD	After the tests		
8.3.2	Simulation of faults	(See appended table 8.3)	P
8.3.3	Conditions for tests	(See appended table 8.3)	P

9 6/RD	Connection to telecommunication networks		N
6.1/RD	Protection of telecommunication network service persons, and users of other equipment connected to the network, from hazards in the equipment		N
6.1.1/RD	Protection from hazardous voltages		N
6.1.2/RD	Separation of the telecommunication network from earth		N
6.1.2.1/RD	Requirements		N
	Supply voltage (V)		--
	Current in the test circuit (mA)		--
6.1.2.2/RD	Exclusions		N
6.2/RD	Protection of equipment users from overvoltages on telecommunication networks		N
6.2.1/RD	Separation requirements		N
6.2.2/RD	Electric strength test procedure		N
6.2.2.1/RD	Impulse test		N
6.2.2.2/RD	Steady-state test		N
6.2.2.3/RD	Compliance criteria		N
6.3/RD	Protection of the telecommunication wiring system from overheating		N
	Max. output current (A)		--
3.5/RD	Interconnection of equipment		N
3.5.1/RD	General requirements		N
3.5.2/RD	Types of interconnection circuits		N
3.5.3/RD	ELV circuits as interconnection circuits		N
3.5.4/RD	Data ports for additional equipment		N
2.1.3/RD	Protection in restricted access locations		N
2.3.1/RD	Limits		N
	Type of TNV circuits		--

IEC 62040-1			
Clause	Requirement + Test	Result - Remark	Verdict
2.3.2/RD	Separation from other circuits and from accessible parts		P
2.3.2.1/RD	General requirements		P
2.3.2.2/RD	Protection by basic insulation		P
2.3.2.3/RD	Protection by earthing		N
2.3.2.4/RD	Protection by other constructions		N
2.3.3/RD	Separation from hazardous voltages		N
	Insulation employed.....		--
2.3.4/RD	Connection of TNV circuits to other circuits		N
	Insulation employed.....		--
2.3.5/RD	Test for operating voltages generated externally		N
2.6.5.8/RD	Reliance on telecommunication network or cable distribution system		N
2.10.3.3/RD	Clearances in primary circuits	(see appended table 5.7)	N
2.10.3.4/RD	Clearances in secondary circuits	(see appended table 5.7)	N
2.10.4/RD	Creepage distances		N
2.10.4.1/RD	General		N
2.10.4.2/RD	Material group and comparative tracking index		N
	CTI tests		--
2.10.4.3/RD	Minimum creepage distances		N
M/RD	ANNEX M, CRITERIA FOR TELEPHONE RINGING SIGNALS (see 2.3.1/RD)		N
M.1/RD	Introduction		N
M.2 /RD	Method A		N
M.3/RD	Method B		N
M.3.1/RD	Ringing signal		N
M.3.1.1/RD	Frequency (Hz)		--
M.3.1.2/RD	Voltage (V)		--
M.3.1.3/RD	Cadence; time (s), voltage (V)		--
M.3.1.4/RD	Single fault current (mA)		--
M.3.2/RD	Tripping device and monitoring voltage		N
M.3.2.1/RD	Conditions for use of a tripping device or a monitoring voltage		--
M.3.2.2/RD	Tripping device		N
M.3.2.3/RD	Monitoring voltage (V)		N
A/RD	Annex A, Tests for resistance to heat and fire		N
A.1/RD	Flammability test for fire enclosures of movable equipment having a total mass exceeding 18 kg, and of stationary equipment (see 4.7.3.2/RD)		N

IEC 62040-1			
Clause	Requirement + Test	Result - Remark	Verdict
A.1.1/RD	Samples..... :		--
	Wall thickness (mm)..... :		--
A.1.2/RD	Conditioning of samples; temperature (C) ... :		N
A.1.3/RD	Mounting of samples :		N
A.1.4/RD	Test flame (see IEC 60695-11-3)		N
	Flame A, B, C or D :		--
A.1.5/RD	Test procedure		N
A.1.6/RD	Compliance criteria		N
	Sample 1 burning time (s)..... :		--
	Sample 2 burning time (s)..... :		--
	Sample 3 burning time (s)..... :		--
A.2/RD	Flammability test for fire enclosures of movable equipment having a total mass not exceeding 18 kg, and for material and components located inside fire enclosures (see 4.7.3.2/RD and 4.7.3.4/RD)		N
A.2.1/RD	Samples, material..... :		--
	Wall thickness (mm)..... :		--
A.2.2/RD	Conditioning of samples; temperature (°C) :		N
A.2.3/RD	Mounting of samples :		N
A.2.4/RD	Test flame (see IEC 60695-11-4)		N
	Flame A, B or C :		--
A.2.5/RD	Test procedure		N
A.2.6/RD	Compliance criteria		N
	Sample 1 burning time (s)..... :		--
	Sample 2 burning time (s)..... :		--
	Sample 3 burning time (s)..... :		--
A.2.7/RD	(Alternative) test acc. to IEC 60695-11-5, cl. 5 and 9		N
	Sample 1 burning time (s)..... :		--
	Sample 2 burning time (s)..... :		--
	Sample 3 burning time (s)..... :		--
A.3/RD	Hot flaming oil test (see 4.6.2/RD)		N
A.3.1/RD	Mounting of samples		N
A.3.2/RD	Test procedure		N
A.3.3/RD	Compliance criterion		N
B/RD	Annex B, Motor tests under abnormal conditions (see 4.7.2.2/RD and 5.3.2/RD)		N
B.1/RD	General requirements	Approved DC fan used. See appended table 4.5	N
	Position :		N

IEC 62040-1			
Clause	Requirement + Test	Result - Remark	Verdict
	Manufacturer		N
	Type		N
	Rated values		N
B.2/RD	Test conditions		N
B.3/RD	Maximum temperatures		N
B.4/RD	Running overload test		N
B.5/RD	Locked-rotor overload test		N
	Test duration (days)		N
	Electric strength test: test voltage (V)		N
B.6/RD	Running overload test for d.c. motors in secondary circuits		N
B.6.1/RD	General		N
B.6.2/RD	Test procedure		N
B.6.3/RD	(Alternative) test procedure		N
B.6.4/RD	Electric strength test; test voltage (V)		N
B.7/RD	Locked-rotor overload test for d.c. motors in secondary circuits		N
B.7.1/RD	General		N
B.7.2/RD	Test procedure		N
B.7.3/RD	(Alternative) test procedure		N
B.7.4/RD	Electric strength test; test voltage (V)		N
B.8/RD	Test for motors with capacitors		N
B.9/RD	Test for three-phase motors		N
B.10/RD	Test for series motors		N
	Operating voltage (V)		N

C/RD	Annex C, Transformers (see 1.5.4/RD and 5.3.3/RD)		P
	Position	T1 transformer on PS1203_MN1 board	—
	Manufacturer	See appended table 4.5	—
	Type	See appended table 4.5	—
	Rated values	Class B	—
	Method of protection.....	Circuit design	—
C.1/RD	Overload test	See appended table 7.5 and 8.3	P
C.2/RD	Insulation	See appended table C.2	P
	Protection from displacement of windings.....	See appended table C.2	P

D/RD	Annex D, Measuring instruments for touch current tests (see 5.1.4/RD)		P
------	---	--	---

IEC 62040-1			
Clause	Requirement + Test	Result - Remark	Verdict
D.1/RD	Measuring instrument		P
D.2/RD	(Alternative) measuring instrument		N
E/RD	Annex E, Temperature rise of a winding (see Annex E/RD)		N
F/RD	Annex F, Measurements of clearances and creepage distance (see 2.10/RD and Annex G/RD)		P
G/RD	Annex G, (Alternative) method for determining minimum clearances		N
G.1/RD	Clearances		N
G.1.1/RD	General		N
G.1.2/RD	Summary of the procedure for determining minimum clearances		N
G.2/RD	Determination of mains transient voltage (V)		N
G.2.1/RD	AC mains supply		N
G.2.2/RD	Earthed d.c. mains supplies		N
G.2.3/RD	Unearthed d.c. mains supplies		N
G.2.4/RD	Battery operation		N
G.3/RD	Determination of telecommunication network transient voltage (V)		N
G.4/RD	Determination of required withstand voltage (V)		N
G.4.1/RD	Mains transients and internal repetitive peaks :		N
G.4.2/RD	Transients from telecommunication networks . :		N
G.4.3/RD	Combination of transients		N
G.4.4/RD	Transients from cable distribution systems		N
G.5/RD	Measurement of transient voltages (V)		N
	a) Transients from a mains supply		N
	For an a.c. mains supply		N
	For a d.c. mains supply		N
	b) Transients from a telecommunication network		N
G.6/RD	Determination of minimum clearances		N
H	Annex H, Guidance on protection against ingress of water and foreign objects (see IEC 60529)		N
I	Annex I, Backfeed protection test		N
I.1	General		N
I.2	Test for pluggable UPS		N
I.3	Test for permanently connected UPS		N

IEC 62040-1			
Clause	Requirement + Test	Result - Remark	Verdict

I.4	Load-induced change of reference potential		N
I.5	Solid-state backfeed protection (see clause 7.1-7.5 of IEC 62040-2 and clause 7.1-7.2 of IEC 62040-3)		N

J/RD	Annex J, Table of electrochemical potentials (see 2.6.5.6/RD)		P
	Metal(s) used	Copper plated with tin and soldering lead.	

K/RD	Annex K, Thermal controls (see 1.5.3/RD and 5.3.8/RD)		N
K.1/RD	Making and breaking capacity		N
K.2 /RD	Thermostat reliability; operating voltage (V) :		N
K.3/RD	Thermostat endurance test; operating voltage (V)		N
K.4/RD	Temperature limiter endurance; operating voltage (V)		N
K.5/RD	Thermal cut-out reliability		N
K.6/RD	Stability of operation		N

L	Annex L, Reference loads		N
L.1	General		N
L.2	Reference resistive load		N
L.3	Reference inductive-resistive load		--
L.4	Reference capacitive-resistive loads		N
L.5	Reference non-linear load		N
L.5.1	General		N
L.5.2	Test method		N
L.5.3	Connection of the non-linear reference load		N

M	Annex M, Ventilation of battery compartments		P
M.1	General	Sufficient openings and a suitable arrangement of components (circuit breaker) are provided in such a way that a local concentration of hydrogen and oxygen is not possible. No requirement regarding the separation of operational arcing parts from battery vents/valves.	P
M.2	Normal conditions	See appended table M	P
M.3	Blocked conditions		P

IEC 62040-1			
Clause	Requirement + Test	Result - Remark	Verdict
M.4	Overcharge conditions		N
N	Annex N, Minimum and maximum cross-sections of copper conductors suitable for connection (see 6.3)		N
U/RD	Annex U, Insulated winding wires for use without interleaved insulation (see 2.10.5.4/RD)		N
			--
V/RD	Annex V, AC POWER DISTRIBUTION SYSTEMS (see 1.6.1/RD)		P
V.1/RD	Introduction		P
V.2/RD	TN power distribution systems	See sub-clause 1.6.1/RD.	P
V.3/RD	TT power distribution systems		N
V.4/RD	IT power distribution systems	(for Norway only)	P

IEC 62040-1					
Clause	Requirement + Test	Result - Remark			Verdict
4.5	TABLE: list of critical components				P
object/part No.	manufacturer/ trademark	type/model	technical data	standard	mark(s) of conformity ¹⁾
Whole unit					
Enclosure	Various	Various	Steel/Aluminium	--	--
AC fan	EBMPAPST	R2E225BD9209	AC230V, 0.6A, 135W	--	CE
Insulation sheet	FORMEX	Formex GK-10	--	--	UL: E256266/E1218 55
SCR	SEMIKRON	SKKT570_16E	570A 1600V	--	--
wire	Various	Various	---	---	UL: E314168
ON ASY01_PS1203_DR6					
X2 capacitor (C29, C30, C31, C32)	Faratronic	C42P2474K9SC0 00	0.47µF,275V AC	--	UL: E186600 VDE: 40000358
Transformer (T1, T2, T3)	SIDNA	UMS33P1T2	Class B	--	Test with appliance
Optocouplers (U2, U3)	NEC	PS2561L-1-V-F3- A-L	--	--	UL:E72422,
Relay (RLY1, RLY2)	SONGCHUAN	894H-2AH1-F-C	12V 12A	--\	UL: E88991 VDE: 40007827
FUSE (F1, F2, F3)	Hollyland	65NM070H	7A/250VAC	--	UL: E156471
PCB	Various	Various	V-0, 130°C	--	UL
ON ASY01_PS1203_DR9					
PCB	Various	Various	V-0, 130°C	--	UL
ON ASY01_PS1203_KY1					
PCB	Various	Various	V-0, 130°C	--	UL
ON ASY01_PS1203_MN1					
Y2 capacitor (C143)	TDK	CS11- E2GA222MYN S	250VAC/ 2200pF	IEC 60384- 14	UL: E37861 VDE: 124321
Transformer (T1)	Boulder	UMX33MN1T1	CLASS B	--	Test with appliance
FUSE (F1)	Hollyland	50CF F630mAH 250V	630mAH 250V	--	UL: E156471

IEC 62040-1					
Clause	Requirement + Test		Result - Remark		Verdict
PCB	Various	Various	V-0, 130°C	--	UL
ON ASY01_PS1203_PW3					
DC capacitor (C7,C8)	Jianghai	CD293-220UF	450V, 820uF, 85°C	--	UL
X2 capacitor (C1,C2)	Faratronic	C42P2474K9S C000	0.47µF,275VAC	--	UL:E186600 VDE:40000358
Y2 capacitor (C11,C12,C61)	TDK	CS11-E2GA222MYNS	250VAC/2200pF	IEC 60384-14	UL:E37861 VDE:124321
Y1 capacitor (C3,C4,C5,C6,C59,C60)	TDK	CD16-E2GA472MYGS	4.7Nf,400Vac	--	UL:E37861 VDE:124321
Transformer (T1)	SIDNA	UMS33P1T2	Class B	--	Test with appliance
Transformer (T3)	Boulder	UMXPS3T1	CLASS B	--	Test with appliance
PCB	Various	Various	V-0, 130°C	--	UL
ON ASY01_PS1203_TF2					
PCB	Various	Various	V-0, 130°C	--	UL
ON ASY01_PS1203_TF3					
Optocouplers (U6,U7,U8,U9,U10,U11,U12,U13,U19)	NEC	PS2561L-1-V-F3-A-L	--	--	UL: E72422,
Optocouplers (U20)	AVAGO	HCNR201	--	--	UL: E55361
Relay (RLY1,RLY2,RLY3,RLY4)	SONGCHUAN	892-1CC-C-24VDC	24V 3A	--\	UL: E88991 VDE: 40006318
PCB	Various	Various	V-0, 130°C	--	UL
ON ASY01_PS1203_TF4					
PCB	Various	Various	V-0, 130°C	--	UL
ON ASY01_PS1203_TF6					
PCB	Various	Various	V-0, 130°C	--	UL
ON ASY01_PS1503_TF1					
PCB	Various	Various	V-0, 130°C	--	UL
ON ASY01_PS1503_TF2					

IEC 62040-1					
Clause	Requirement + Test		Result - Remark	Verdict	
PCB	Various	Various	V-0, 130°C	--	UL
ON ASY01_PS1507_EM2					
Y2 capacitor (C8,C9,C10)	TDK	CS11- E2GA222MYN S	250VAC/ 2200pF	IEC 60384- 14	UL: E37861 VDE: 124321
X2 capacitor (C11,C12,C13, C14,C15,C16)	Faratronic	C42P2565- BSC000	250VAC/ 5.6µF	--	UL:E186600 VDE: 40000358
PCB	Various	Various	V-0, 130°C	--	UL
ON ASY01_PS1507_EM3					
FUSE (F1,F2,F3)	BUSSMANN	BK-GBH- V030A6FR	30A/500VAC	--	UL: E56412
PCB	Various	Various	V-0, 130°C	--	UL
ON SNT_DL_3320_FR_01					
X2 capacitor (C1,C2,C3,C4)	Faratronic	C43Q1224MB 0C450	250VAC/ 0.22µF	--	UL:E186600 VDE: 40000358
Y2 capacitor (C5,C6,C7,C8, C9,C10,C11,C 12,C13,C14)	TDK	CS11- E2GA222MYN S	250VAC/ 2200pF	IEC 60384- 14	UL:E37861 VDE: 124321
PCB	Various	Various	V-0, 130°C	--	UL
¹⁾ an asterisk indicates a mark which assures the agreed level of surveillance.					

IEC 62040-1			
Clause	Requirement + Test	Result - Remark	Verdict

4.4	TABLE: electrical data (in normal conditions)					P
Fuse#	I rated(A)	U(V)	P(W)	I(A)	I fuse (A)	Condition/status
Input breaker	--	342/50Hz	473684	787.45	--	O/P: 380V, 50Hz, 760A, 450KW
Input breaker	--	342/60Hz	473684	787.45	--	O/P: 380V, 50Hz, 760A, 450KW
Input breaker	720	380/50Hz	473684	717.70	--	O/P: 380V, 50Hz, 760A, 450KW
Input breaker	720	380/60Hz	473684	717.70	--	O/P: 380V, 50Hz, 760A, 450KW
Input breaker	720	400/50Hz	472689	685.06	--	O/P: 380V, 50Hz, 760A, 450KW
Input breaker	720	400/60Hz	472689	685.06	--	O/P: 380V, 50Hz, 760A, 450KW
Input breaker	720	415/50Hz	476190	661.38	--	O/P: 380V, 50Hz, 760A, 450KW
Input breaker	720	415/60Hz	476190	661.38	--	O/P: 380V, 50Hz, 760A, 450KW
Input breaker	--	456.5/50Hz	478723	620.91	--	O/P: 380V, 50Hz, 760A, 450KW
Input breaker	--	456.5//60Hz	478723	620.91	--	O/P: 380V, 50Hz, 760A, 450KW
Input breaker	--	342/50Hz	473186	786.61	--	O/P: 400V, 50Hz, 760A, 450KW
Input breaker	--	342/60Hz	473186	786.61	--	O/P: 400V, 50Hz, 760A, 450KW
Input breaker	720	380/50Hz	473186	716.95	--	O/P: 400V, 50Hz, 760A, 450KW
Input breaker	720	380/60Hz	473186	716.95	--	O/P: 400V, 50Hz, 760A, 450KW
Input breaker	720	400/50Hz	472193	684.34	--	O/P: 400V, 50Hz, 760A, 450KW
Input breaker	720	400/60Hz	472193	684.34	--	O/P: 400V, 50Hz, 760A, 450KW
Input breaker	720	415/50Hz	475687	660.68	--	O/P: 400V, 50Hz, 760A, 450KW
Input breaker	720	415/60Hz	475687	660.68	--	O/P: 400V, 50Hz, 760A, 450KW
Input breaker	--	456.5/50Hz	478215	620.25	--	O/P: 400V, 50Hz, 760A, 450KW
Input breaker	--	456.5//60Hz	478215	620.25	--	O/P: 400V, 50Hz, 760A, 450KW

IEC 62040-1						
Clause	Requirement + Test				Result - Remark	Verdict
Input breaker	--	342/50Hz	473186	786.61	--	O/P: 415V, 50Hz, 760A, 450KW
Input breaker	--	342/60Hz	473186	786.61	--	O/P: 415V, 50Hz, 760A, 450KW
Input breaker	720	380/50Hz	473186	716.95	--	O/P: 415V, 50Hz, 760A, 450KW
Input breaker	720	380/60Hz	473186	716.95	--	O/P: 415V, 50Hz, 760A, 450KW
Input breaker	720	400/50Hz	472193	684.34	--	O/P: 415V, 50Hz, 760A, 450KW
Input breaker	720	400/60Hz	472193	684.34	--	O/P: 415V, 50Hz, 760A, 450KW
Input breaker	720	415/50Hz	475687	660.68	--	O/P: 415V, 50Hz, 760A, 450KW
Input breaker	720	415/60Hz	475687	660.68	--	O/P: 415V, 50Hz, 760A, 450KW
Input breaker	--	456.5/50Hz	478215	620.25	--	O/P: 415V, 50Hz, 760A, 450KW
Input breaker	--	456.5//60Hz	478215	620.25	--	O/P: 415V, 50Hz, 760A, 450KW
Input breaker	--	342V/50Hz	473684	787.45	--	O/P: 380V, 60Hz, 760A, 450KW
Input breaker	--	342V/60Hz	473684	787.45	--	O/P: 380V, 60Hz, 760A, 450KW
Input breaker	720	380V/50Hz	473684	717.70	--	O/P: 380V, 60Hz, 760A, 450KW
Input breaker	720	380V/60Hz	473684	717.70	--	O/P: 380V, 60Hz, 760A, 450KW
Input breaker	720	400V/50Hz	472689	685.06	--	O/P: 380V, 60Hz, 760A, 450KW
Input breaker	720	400V/60Hz	472689	685.06	--	O/P: 380V, 60Hz, 760A, 450KW
Input breaker	720	415V/50Hz	476190	661.38	--	O/P: 380V, 60Hz, 760A, 450KW
Input breaker	720	415V/60Hz	476190	661.38	--	O/P: 380V, 60Hz, 760A, 450KW
Input breaker	--	456.5/50Hz	478723	620.91	--	O/P: 380V, 60Hz, 760A, 450KW
Input breaker	--	456.5//60Hz	478723	620.91	--	O/P: 380V, 60Hz, 760A, 450KW
Input breaker	--	342V/50Hz	473186	786.61	--	O/P: 400V, 60Hz, 760A, 450KW

IEC 62040-1						
Clause	Requirement + Test				Result - Remark	Verdict
Input breaker	--	342V/60Hz	473186	786.61	--	O/P: 400V, 60Hz, 760A, 450KW
Input breaker	720	380V/50Hz	473186	716.95	--	O/P: 400V, 50Hz, 760A, 450KW
Input breaker	720	380V/60Hz	473186	716.95	--	O/P: 400V, 60Hz, 760A, 450KW
Input breaker	720	400V/50Hz	472193	684.34	--	O/P: 400V, 50Hz, 760A, 450KW
Input breaker	720	400V/60Hz	472193	684.34	--	O/P: 400V, 60Hz, 760A, 450KW
Input breaker	720	415V/50Hz	475687	660.68	--	O/P: 400V, 50Hz, 760A, 450KW
Input breaker	720	415V/60Hz	475687	660.68	--	O/P: 400V, 60Hz, 760A, 450KW
Input breaker	--	456.5/50Hz	478215	620.25	--	O/P: 400V, 50Hz, 760A, 450KW
Input breaker	--	456.5//60Hz	478215	620.25	--	O/P: 400V, 60Hz, 760A, 450KW
Input breaker	--	342V/50Hz	473186	786.61	--	O/P: 415V, 60Hz, 760A, 450KW
Input breaker	--	342V/60Hz	473186	786.61	--	O/P: 415V, 60Hz, 760A, 450KW
Input breaker	720	380V/50Hz	473186	716.95	--	O/P: 415V, 60Hz, 760A, 450KW
Input breaker	720	380V/60Hz	473186	716.95	--	O/P: 415V, 60Hz, 760A, 450KW
Input breaker	720	400V/50Hz	472193	684.34	--	O/P: 415V, 60Hz, 760A, 450KW
Input breaker	720	400V/60Hz	472193	684.34	--	O/P: 415V, 60Hz, 760A, 450KW
Input breaker	720	415V/50Hz	475687	660.68	--	O/P: 415V, 60Hz, 760A, 450KW
Input breaker	720	415V/60Hz	475687	660.68	--	O/P: 415V, 60Hz, 760A, 450KW
Input breaker	--	456.5/50Hz	478215	620.25	--	O/P: 415V, 60Hz, 760A, 450KW
Input breaker	--	456.5//60Hz	478215	620.25	--	O/P: 415V, 60Hz, 760A, 450KW
Note(s): Please measure the input currents with normal load.						

5.1.1 and 2.1.1.7/RD	TABLE: discharge of capacitors in the primary circuit	P
----------------------	---	---

IEC 62040-1					
Clause	Requirement + Test			Result - Remark	Verdict
Condition	τ calculated (s)	τ measured (s)	$t_{u \rightarrow 0V}$ (s)	Comments	
Input L1-N	--	0.48	2.02	Tested at online mode with batteries	
Input L2-N	--	0.44	1.85		
Input L3-N	--	0.44	1.85		
Input L1-PE	--	0.46	1.93		
Input L2-PE	--	0.44	1.85		
Input L3-PE	--	0.42	1.76		
Input N-PE	--	0	0.00		
BAT+-PE	--	0.21	0.88	Battery mode to shut down	
BAT--PE	--	0.23	0.97		
Input L1-N	--	0.25	1.05	Tested at bypass mode without batteries	
Input L2-N	--	0.23	0.97		
Input L3-N	--	0.25	1.05		
Input L1-PE	--	0.48	2.02		
Input L2-PE	--	0.5	2.10		
Input L3-PE	--	0.5	2.10		
Input N-PE	--	0	0.00		
Note(s): Input 498/60Hz					

5.1.4	TABLE: Backfeed protection test			N
Condition	Voltage measured (V)/current (mA)			Comments
	A-N	A-G	N-G	
--	--	--	--	--
Note(s):				

5.2.1 and 2.2.2/RD	TABLE: SELV measurement (under normal conditions)				P
Transformer	Location	Voltage (max.) (V)		Voltage Limitation Component	
		V peak	V d.c.		
PS1203_MN1 board					
T1	pin 9-10	65.0	32.0	--	
	After D56 to pin 9	14.8	14.2	D56	
	pin 6-7	55.0	22.8	--	

IEC 62040-1			
Clause	Requirement + Test	Result - Remark	Verdict

	After D54 to pin 7	14.8	14.2	D54
Supplementary information:				

5.2.1 and 2.2.3/RD	TABLE: SELV measurement (under fault conditions)			P
Location	Voltage (max.) (V)	Comments		
PS1203_MN1 board				
D56	0	Short-circuit diode D56		
D54	0	Short-circuit diode D54		
Supplementary information:				

5.2.3 and 2.4.2/RD	TABLE: Limited current circuit measurement				N
Location	Voltage (V)	Current (mA)	Freq. (kHz)	Limit (mA)	Comments
--	--	--	--	--	--
Supplementary information:					

5.2.5 and 2.5/RD	TABLE: Limited power source measurement			N
	Limits	Measured	Verdict	
According to Table 2B/2C (normal condition)				
current (in A)	--	--	--	
apparent power (in VA)	--	--	--	
According to Table 2B/2C (single fault condition)				
current (in A)	--	--	--	
apparent power (in VA)	--	--	--	
Supplementary information:				

5.3.1 and 2.6.3.4/RD	TABLE: Resistance of earthing measurement			P
Location	Resistance measured (mΩ)	Comments		
Input PE to earthed enclosure furthest	1.2	1600A/10min		
Supplementary information: Earthing continuity is achieved by sufficient conductor size. See relevant clauses.				

IEC 62040-1

Clause	Requirement + Test	Result - Remark	Verdict			
7.5 and 8.3	TABLE: fault condition tests	--	P			
	ambient temperature (°C)	--				
	model/type of power supply	--				
	manufacturer of power supply	--				
	rated markings of power supply	--				
com- ponent No.	fault	test voltage (V)	test time	fuse No.	fuse current (A)	result
Output	s-c	415	1s	--	--	UPS output shut down immediately, the charger operate normally, no damaged. Charge voltage: 576V, Output voltage: 0V.
Output	s-c	battery	1s	--	--	UPS output shut down immediately, no damaged. Charge voltage: 0V, Output voltage: 0V.
Output	o-l	415	15min	--	--	UPS output shut down at condition of 5min at 100% load + 5min at 117% load + 2s at 133% load.
Output	o-l	Battery mode	15min	--	--	UPS output shut down at condition of 5min at 100% load + 5min at 117% load + 2s at 133% load.
BYP-SCR	s-c	415	--	--	--	Bypass supply. No damage. No hazards. Warning signal alarm sounds. LCD display Warning information (Bypass failed, Inverter supply prohibited).
Ventilation openings	Block-ed	415	30min.	--	--	UPS shut down at temperature protection, after the temperature is below 60°C, UPS open up. Repeat the cycle continuously.
Ventilation openings	Block-ed	Battery mode	30min	--	--	UPS shut down at temperature protection, after the temperature is below 60°C, UPS open up. Repeat the cycle continuously.

IEC 62040-1						
Clause	Requirement + Test			Result - Remark		Verdict
Fan	Locked	415	30mins	--	--	UPS shut down at temperature protection, after the temperature is below 60°C, UPS open up. Repeat the cycle continuously.
Fan	Locked	Battery mode	30mins	--	--	UPS shut down at temperature protection, after the temperature is below 60°C, UPS open up. Repeat the cycle continuously.
PS1203_MN1 board						
Pin 2-4 of T1	S-C	415	1.5hr	Input breaker	--	Worked normally. No damage. No hazards.
Pin 6-7 of T1	S-C	415	2.3hr	Input breaker	--	Worked normally. No damage. No hazards.
Pin 9-10 of T1	O-L	415	40min	Input breaker	--	Normal work. No damage. No hazards.
U14 pin 1-2	S-C	415	10 min	Input breaker	--	UPS output shut down. UPS transfer to bypass mode immediately. Warning signal alarm sounds immediately (input over voltage. UPM shutdown. Transfer to Bypass). Recoverable after fault removed. No damage. No hazards.
U14 pin 3-4	S-C	415	10 min	Input breaker	--	UPS output shut down. UPS transfer to bypass mode immediately. Warning signal alarm sounds immediately (input over voltage. UPM shutdown. Transfer to Bypass). Recoverable after fault removed. No damage. No hazards.
U14 pin 1	O-C	415	10 min	Input breaker	--	UPS output shut down. UPS transfer to bypass mode immediately. Warning signal alarm sounds immediately (input over voltage. UPM shutdown. Transfer to Bypass). Recoverable after fault removed. No damage. No hazards.

IEC 62040-1						
Clause	Requirement + Test				Result - Remark	Verdict
U14 pin 3	O-C	415	10 min	Input breaker	--	UPS output shut down. UPS transfer to bypass mode immediately. Warning signal alarm sounds immediately (input over voltage. UPM shutdown. Transfer to Bypass). Recoverable after fault removed. No damage. No hazards.
<p>Note(s): s-c means short circuit. o-l means overload. o-p means open circuit.</p>						

5.7 and 2.10.2/RD	TABLE: working voltage measurement				P
Location	RMS voltage (V)	Peak voltage (V)	comments		
PS1203_MN1 board					
T1 Pin2--6	92.7	138	--		
T1 Pin2--7	93.2	146	--		
T1 Pin2--9	93.0	140	--		
T1 Pin2--10	92.7	138	--		
T1 Pin4--6	93.2	152	Max. peak voltage		
T1 Pin4--7	92.7	142	--		
T1 Pin4--9	92.7	138	--		
T1 Pin4--10	93.4	150	Max. RMS voltage		
Note:					

5.7 and 2.10.4/RD	TABLE: clearance and creepage distance measurements					P
clearance cl and creepage distance dcr at/of:	Up (V)	U r.m.s. (V)	required cl (mm)	cl (mm)	required dcr (mm)	dcr (mm)
On PS1203_MN1 board						
Primary trace to secondary trace under U25, U13, U16, U14, U29(RI)	420	240	4.0	>5.0	5.0	>5.0
Primary trace to secondary trace under T1 (RI)	420	240	4.0	>5.0	5.0	>5.0
UPS						
Metal enclosure to bare pin of battery terminal (BI)	420	250	2.0	5.5	2.8	5.5

IEC 62040-1						
Clause	Requirement + Test	Result - Remark				Verdict
Primary pin to earthed metal plate on Input EMI PCB (BI)	420	250	2.0	5.0	2.8	>5.0
Primary pin to earthed metal enclosure on Output EMI PCB (BI)	420	250	2.0	8.0	2.8	>8.0
Note(s):						

5.8, 2.1.1.3/RD and 2.10.5.1/RD	TABLE: Distance through insulation measurements					P
Distance through insulation (DTI) at/of:	U peak (V)	U r.m.s. (V)	Test voltage (V)	Required DTI (mm)	DTI (mm)	
Mylar tape for transformer T1 on MN1 board	340	240	3000	0.4	0.5	
Supplementary information:						

6, 8.2 and 9	TABLE: Electric strength tests, impulse tests and voltage surge tests				P
Test voltage applied between:	Voltage shape (AC, DC, impulse, surge)	Test voltage (V)	Breakdown Yes / No		
Functional:	--	--	--	--	
Basic / supplementary:					
Primary to earthing	AC	1500	No		
Reinforced:					
Primary to SELV	AC	3000	No		
Supplementary information:					

7.4, 4.5.5/RD	TABLE: Ball pressure test of thermoplastic parts				N
	Allowed impression diameter (mm)	≤ 2 mm			
Part	Test temperature (°C)	Impression diameter (mm)			
--	--	--			
Supplementary information:					

7.5	TABLE: resistance to fire				P
-----	---------------------------	--	--	--	---

IEC 62040-1			
Clause	Requirement + Test	Result - Remark	Verdict
Part	Manufacturer of material	Type of material	Thickness (mm)
--	--	--	--
Supplementary information: see table 4.5			

7.7	TABLE: temperature rise measurements						P
	Supply voltage (V)	342/60 Hz*	456.5/5 0Hz*	Battery mode	--	--	—
	Ambient T _{min} (°C)	--	--	--	--	--	—
	Ambient T _{max} (°C)	--	--	--	--	--	—
Maximum measured temperature T of part/at:		T (°C)					Allowed T _{max} (°C)
UPS internal							
	Enclosure (plastic panel)	45.1	54.6	43.2	--	--	95
	Enclosure (metal)	49.2	56.3	50.3	--	--	70
	AC terminal	61.2	57.9	60.4	--	--	90
	AC Air-Switch	53.3	58.9	51.8	--	--	85
	DC Fan	59.8	59.4	59.1	--	--	70
	Battery terminal	47.3	55.2	58.5	--	--	Ref.
	Copper	78.6	69.4	76.4	--	--	90
	BYP—SCR	106.2	116.6	47.5	--	--	130
PS1203_MN1 board							
	Y Capacitor on MN1 board	58.3	57.5	58.7	--	--	125
	Transformer (T1) coil on MN1 board	56.3	55.7	58.4	--	--	110
	Transformer (T1) core on TF3 board	51.2	51.0	52.8	--	--	110
	Opto coupler on MN1 board	52.3	51.8	52.5	--	--	100
	PCB near transformer T1 on MN1board	51.8	50.6	51.2	--	--	130
	Ambient	40.0	40.0	40.0	--	--	--
Supplementary information:							
	Temperature T of winding:	t ₁ (°C)	R ₁ (Ω)	t ₂ (°C)	R ₂ (Ω)	T (°C)	Allowed T _{max} (°C)
		--	--	--	--	--	--
Supplementary information: “*” output loading with 380V, 760 450KW							

8.1	TABLE: touch current measurement			P
Measured between:	measured	Limit	Comments	

IEC 62040-1					
Clause	Requirement + Test			Result - Remark	Verdict
	Line mode (mA)	Bypass (mA)	(mA)		
Metal enclosure to terminal A (three phase balance)	2.1	1.3	3.5	TN system	
Metal enclosure to terminal A under R-phase imbalance	0.89	1.4	3.5	TN system	
Metal enclosure to terminal A under S-phase imbalance	0.86	1.13	3.5	TN system	
Metal enclosure to terminal A under T-phase imbalance	0.91	1.65	3.5	TN system	
Parallel port to terminal A	0.01	0.01	0.25	TN system	
RS-232 terminal to terminal A	0.05	0.05	0.25	TN system	
LCD to terminal A	0.01	0.01	0.25	TN system	
Supplementary information:					

IEC 62040-1							
Clause	Requirement + Test			Result - Remark			Verdict
C.2/RD	Safety isolation transformer						P
Loc.	Tested insulation	Working voltage peak / V (2.10.2)	Working voltage rms / V (2.10.2)	Required electric strength (5.2)	Required clearance / mm (2.10.2)	Required creepage distance / mm (2.10.4)	Required distance thr. Insul. (2.10.5)
T1 on PS1203_M N1 board	Pri. To sec.: Reinforced insulation	420	240	3000VAC	4.0	5.0	- Triple insulated wire
Loc.	Tested insulation	Working voltage peak / V (2.10.2)	Working voltage rms / V (2.10.2)	Required electric strength (5.2)	Required clearance / mm (2.10.2)	Required creepage distance / mm (2.10.4)	Required distance thr. Insul. (2.10.5)
T1 on PS1203_M N1 board	Pri. To sec.: Reinforced insulation			3000VAC	>4.0	>5.0	- Triple insulated wire
T1 on PS1203_M N1 board	core. To sec.: Reinforced insulation			3000VAC	>4.0	>5.0	- Triple insulated wire

IEC 62040-1			
Clause	Requirement + Test	Result - Remark	Verdict
M	Ventilation of battery compartments		P
	The required dimension for the ventilation openings will be calculated with the following formula:		
	$A > K1 * Q$ with $Q = (0.054 \text{ m}^3/\text{Ah}) * n * I * C$		
	where: K1 : constant factor of $28 \text{ h} * \text{cm}^2/\text{m}^3$ Q : airflow in m^3/h n : number of battery cells I : constant factor ($0,2\text{A}/100\text{Ah}$ for valve regulated lead acid batteries) C : nominal capacity of the battery		
	With the specific data for the UPS the following dimension for the ventilation openings is required:		
	External battery pack n : 6 C : 12		
	$A > 28 \text{ h} * \text{cm}^2/\text{m}^3 * (0.054 \text{ m}^3/\text{Ah}) * n * 0.2 \text{ A}/100 \text{ Ah} * C$		
	$A > 0.22\text{cm}^2$		
	Verdict		
	The size of ventilation openings in battery cabinet exceeds the required airflow by far.		

Appendix 1

European group differences and national differences of EN 62040-1			
Clause	Requirement + Test	Result - Remark	Verdict

EN 62040-1, GROUP DIFFERENCES (CENELEC common modifications EN)																																																															
Clause	Requirement + Test	Result - Remark	Verdict																																																												
Contents	Add the following annexes: Annex ZA (normative) Normative references to international publications with their corresponding European publications Annex ZB (normative) Special national conditions		P																																																												
ZA	<p>NORMATIVE REFERENCES TO INTERNATIONAL PUBLICATIONS WITH THEIR CORRESPONDING EUROPEAN PUBLICATIONS</p> <p>The following referenced documents are indispensable for the application of this document. For dated references, only the edition cited applies. For undated references, the latest edition of the referenced document (including any amendments) applies.</p> <p>Note: When an international publication has been modified by common modifications, indicated by (mod), the relevant EN/HD Applies.</p> <table border="1"> <thead> <tr> <th>Publication</th> <th>Year</th> <th>Title</th> <th>EN/HD</th> <th>Year</th> </tr> </thead> <tbody> <tr> <td>IEC 60364-4-42</td> <td>-¹⁾</td> <td>Electrical installations of buildings - Part 4-42: Protection for safety - Protection against thermal effects</td> <td>-</td> <td>-</td> </tr> <tr> <td>IEC 60417</td> <td>Data-base</td> <td>Graphical symbols for use on equipment</td> <td>-</td> <td>-</td> </tr> <tr> <td>IEC 60529</td> <td>-¹⁾</td> <td>Degrees of protection provided by enclosures (IP Code)</td> <td>EN 60529 + corr. May</td> <td>1991²⁾ 1993</td> </tr> <tr> <td>IEC 60664</td> <td>Series</td> <td>Insulation coordination for equipment within low-voltage systems</td> <td>EN 60664</td> <td>Series</td> </tr> <tr> <td>IEC/TR 60755</td> <td>-¹⁾</td> <td>General requirements for residual current operated protective devices</td> <td>-</td> <td>-</td> </tr> <tr> <td>IEC 60950-1 (mod)</td> <td>2005</td> <td>Information technology equipment - Safety - Part 1: General requirements</td> <td>EN 60950-1</td> <td>2006</td> </tr> <tr> <td>IEC 61000-2-2</td> <td>-¹⁾</td> <td>Electromagnetic compatibility (EMC) - Part 2-2: Environment - Compatibility levels for low-frequency conducted disturbances and signalling in public low-voltage power supply systems</td> <td>EN 61000-2-2</td> <td>2002²⁾</td> </tr> <tr> <td>IEC 61008-1 (mod)</td> <td>-¹⁾</td> <td>Residual current operated circuit-breakers without integral overcurrent protection for household and similar uses (RCCB's) - Part 1: General rules</td> <td>EN 61008-1 + A11</td> <td>2004²⁾ 2007</td> </tr> <tr> <td>IEC 61009-1 (mod)</td> <td>-¹⁾</td> <td>Residual current operated circuit-breakers with integral overcurrent protection for household and similar uses (RCBO's) - Part 1: General rules</td> <td>EN 61009-1 + corr. July + A11</td> <td>2004²⁾ 2006 2008</td> </tr> <tr> <td>IEC 62040-2</td> <td>2005</td> <td>Uninterruptible power systems (UPS) - Part 2: Electromagnetic compatibility (EMC) requirements</td> <td>EN 62040-2 + corr. November</td> <td>2006 2006</td> </tr> <tr> <td>IEC 62040-3 (mod)</td> <td>1999</td> <td>Uninterruptible power systems (UPS) - Part 3: Method of specifying the performance and test requirements</td> <td>EN 62040-3</td> <td>2001</td> </tr> </tbody> </table> <p>¹⁾ Undated reference. ²⁾ Valid edition at date of issue.</p>	Publication	Year	Title	EN/HD	Year	IEC 60364-4-42	- ¹⁾	Electrical installations of buildings - Part 4-42: Protection for safety - Protection against thermal effects	-	-	IEC 60417	Data-base	Graphical symbols for use on equipment	-	-	IEC 60529	- ¹⁾	Degrees of protection provided by enclosures (IP Code)	EN 60529 + corr. May	1991 ²⁾ 1993	IEC 60664	Series	Insulation coordination for equipment within low-voltage systems	EN 60664	Series	IEC/TR 60755	- ¹⁾	General requirements for residual current operated protective devices	-	-	IEC 60950-1 (mod)	2005	Information technology equipment - Safety - Part 1: General requirements	EN 60950-1	2006	IEC 61000-2-2	- ¹⁾	Electromagnetic compatibility (EMC) - Part 2-2: Environment - Compatibility levels for low-frequency conducted disturbances and signalling in public low-voltage power supply systems	EN 61000-2-2	2002 ²⁾	IEC 61008-1 (mod)	- ¹⁾	Residual current operated circuit-breakers without integral overcurrent protection for household and similar uses (RCCB's) - Part 1: General rules	EN 61008-1 + A11	2004 ²⁾ 2007	IEC 61009-1 (mod)	- ¹⁾	Residual current operated circuit-breakers with integral overcurrent protection for household and similar uses (RCBO's) - Part 1: General rules	EN 61009-1 + corr. July + A11	2004 ²⁾ 2006 2008	IEC 62040-2	2005	Uninterruptible power systems (UPS) - Part 2: Electromagnetic compatibility (EMC) requirements	EN 62040-2 + corr. November	2006 2006	IEC 62040-3 (mod)	1999	Uninterruptible power systems (UPS) - Part 3: Method of specifying the performance and test requirements	EN 62040-3	2001		—
Publication	Year	Title	EN/HD	Year																																																											
IEC 60364-4-42	- ¹⁾	Electrical installations of buildings - Part 4-42: Protection for safety - Protection against thermal effects	-	-																																																											
IEC 60417	Data-base	Graphical symbols for use on equipment	-	-																																																											
IEC 60529	- ¹⁾	Degrees of protection provided by enclosures (IP Code)	EN 60529 + corr. May	1991 ²⁾ 1993																																																											
IEC 60664	Series	Insulation coordination for equipment within low-voltage systems	EN 60664	Series																																																											
IEC/TR 60755	- ¹⁾	General requirements for residual current operated protective devices	-	-																																																											
IEC 60950-1 (mod)	2005	Information technology equipment - Safety - Part 1: General requirements	EN 60950-1	2006																																																											
IEC 61000-2-2	- ¹⁾	Electromagnetic compatibility (EMC) - Part 2-2: Environment - Compatibility levels for low-frequency conducted disturbances and signalling in public low-voltage power supply systems	EN 61000-2-2	2002 ²⁾																																																											
IEC 61008-1 (mod)	- ¹⁾	Residual current operated circuit-breakers without integral overcurrent protection for household and similar uses (RCCB's) - Part 1: General rules	EN 61008-1 + A11	2004 ²⁾ 2007																																																											
IEC 61009-1 (mod)	- ¹⁾	Residual current operated circuit-breakers with integral overcurrent protection for household and similar uses (RCBO's) - Part 1: General rules	EN 61009-1 + corr. July + A11	2004 ²⁾ 2006 2008																																																											
IEC 62040-2	2005	Uninterruptible power systems (UPS) - Part 2: Electromagnetic compatibility (EMC) requirements	EN 62040-2 + corr. November	2006 2006																																																											
IEC 62040-3 (mod)	1999	Uninterruptible power systems (UPS) - Part 3: Method of specifying the performance and test requirements	EN 62040-3	2001																																																											

Appendix 1

European group differences and national differences of EN 62040-1			
Clause	Requirement + Test	Result - Remark	Verdict
<p>ZB ANNEX (normative)</p> <p>SPECIAL NATIONAL CONDITIONS (EN)</p> <p>The FI, NO and SE - SNCs originate from IEC 60950-1 2nd Edition, which is the reference document (RD) for IEC 62040-1. The national requirements are included in IEC 62040-1 through the following statement in the scope of the standard: <i>“National requirements additional to those in IEC 60950-1 apply and are found as notes under relevant clauses of the RD.”</i></p> <p>The national requirements have not been specifically listed in the EN 62040-1:2008. If demanded, CLC/TC 22X will be requested to take proper measures to complete EN 62040-1 with Annexes ZB containing the SNCs as presented below.</p> <p>EN 62040-1:2008 supersedes EN 62040-1-1:2003. As a reference, see also SNCs for Finland, Norway and Sweden as included in the earlier EN 62040-1-1:2003</p>			
Clause	Requirement + Test	Result - Remark	Verdict
4.7.3	<p>In Finland, Norway and Sweden, when safety relies upon connection to the safety earth (see 5.3), a pluggable equipment type A UPS shall have a marking on the equipment, stating that the UPS must be connected to an earthed mains socket-outlet.</p> <p>The marking text in the applicable countries shall be as follows:</p> <p>In Finland: "Laite on liitettävä suojakoskettimilla varustettuun pistorasiaan"</p> <p>In Norway: "Apparatet må tilkoples jordet stikkontakt"</p> <p>In Sweden: "Apparaten skall anslutas till jordat uttag"</p>		P
4.7.11	<p>In Norway, because of a widely used IT power system, equipment shall be designed or modified for connection to such a system and shall be marked by a label with the following wording in Norwegian: "Apparatet er egnet for tilkoping til et IT forsyningsnett"</p>		P
9	<p>In Finland, Norway and Sweden requirements of 6.1.2.1 and 6.1.2.2 in Annex ZB of EN 60950-1:2001 apply.</p>		P

Appendix 2
Product photos



Fig. 1 – Front view for UPS

Appendix 2
Product photos



Fig. 2 – Rear view for UPS

Appendix 2
Product photos



Fig. 3 –Inside view for UPS

Appendix 2
Product photos

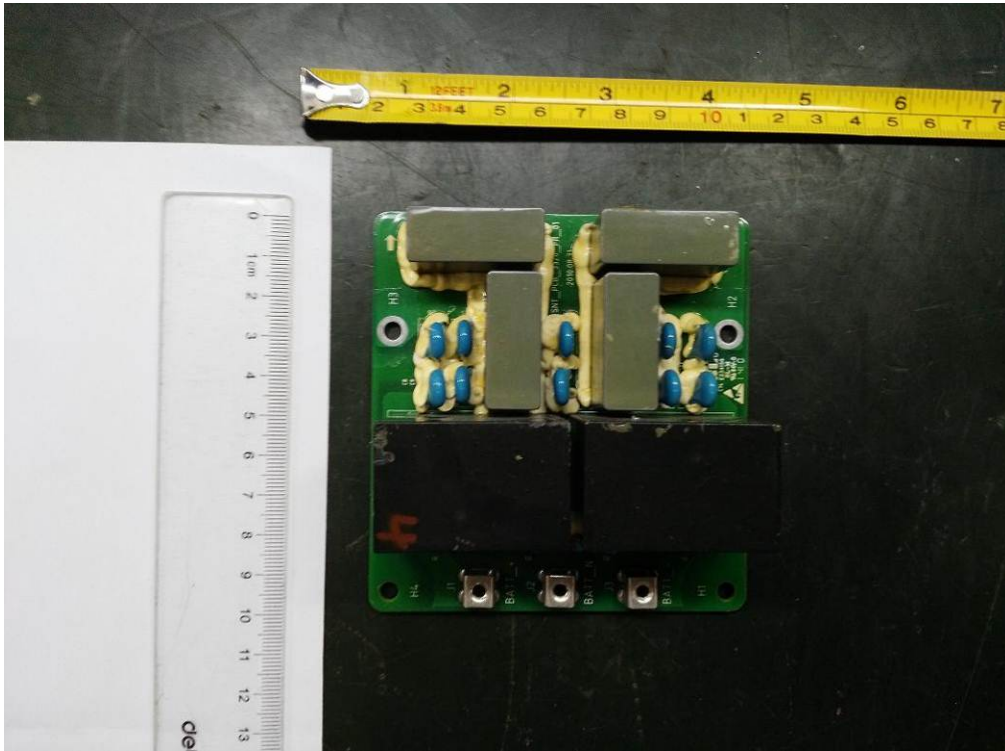

Fig. 4 – PCB view

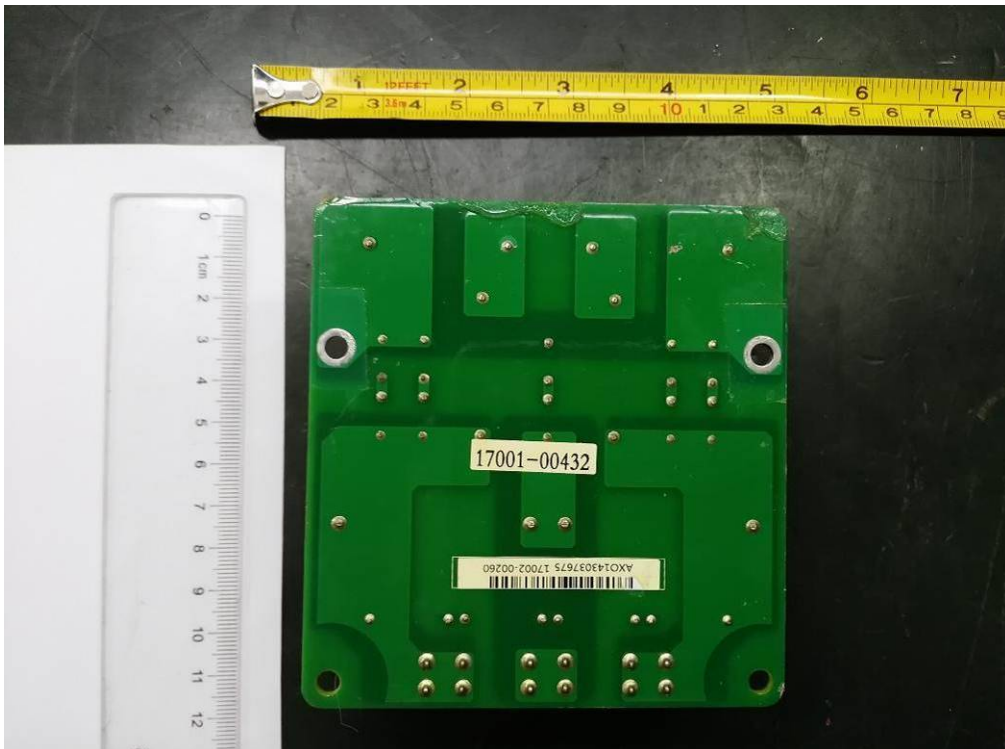

Fig. 5 – PCB view

Appendix 2
Product photos

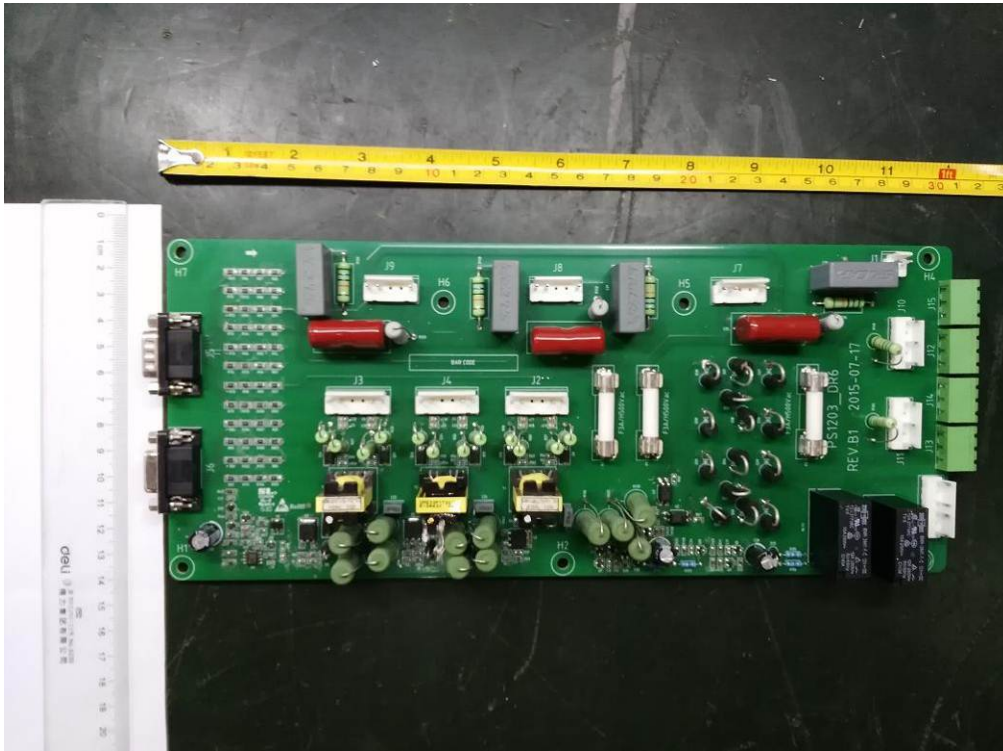

Fig. 6 – PCB view

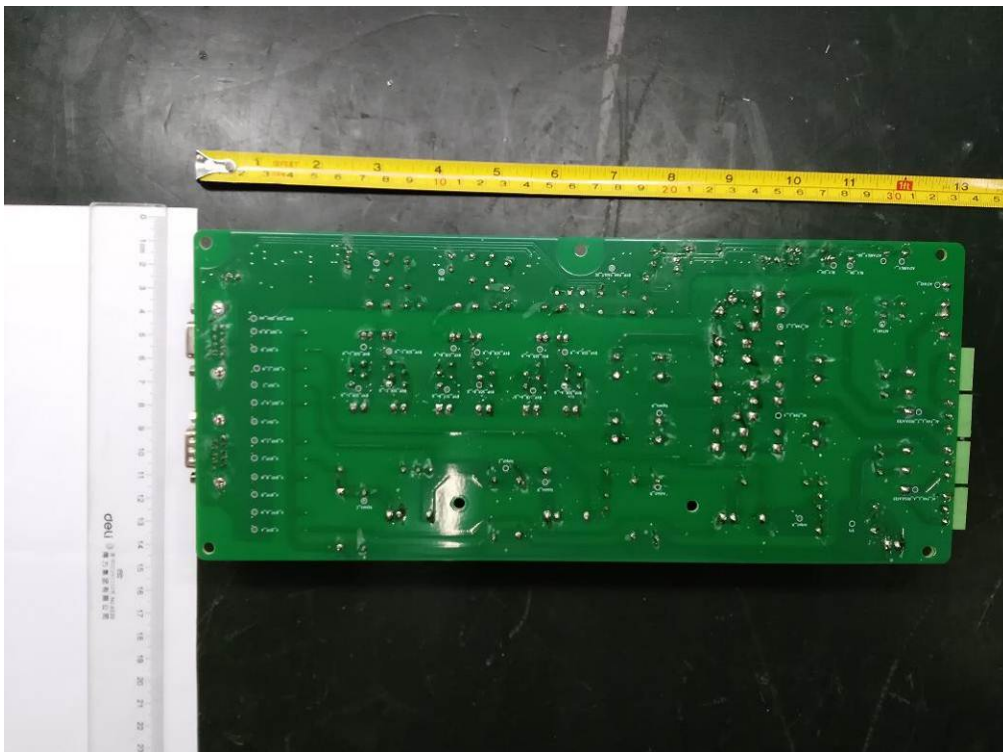

Fig. 7 – PCB view

Appendix 2
Product photos

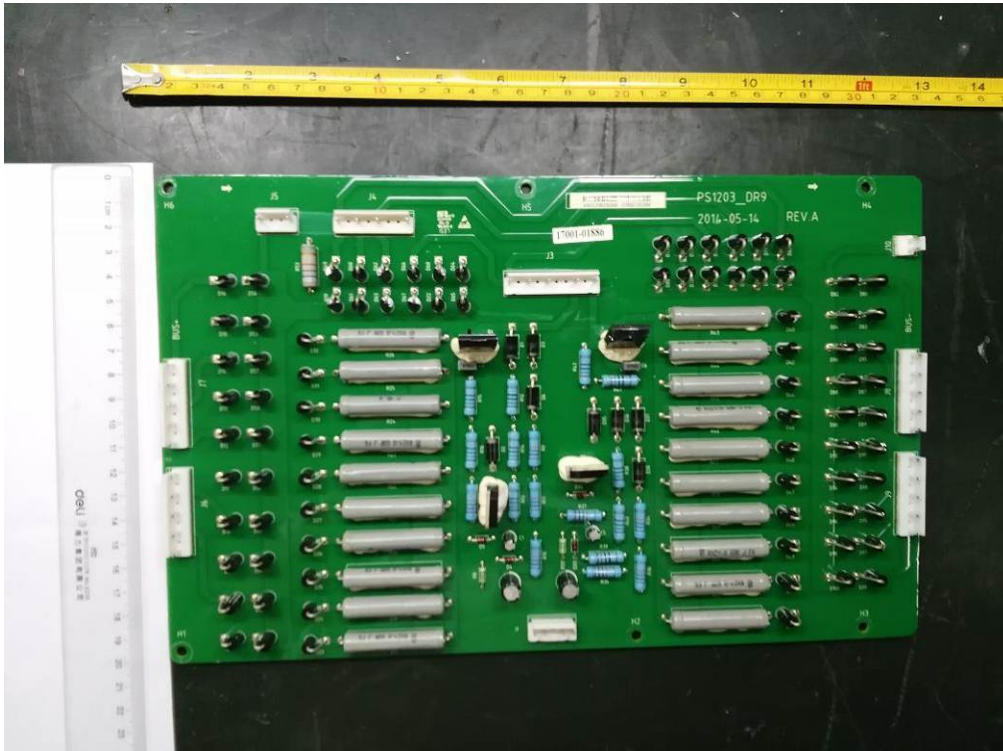

Fig. 8 –PCB view

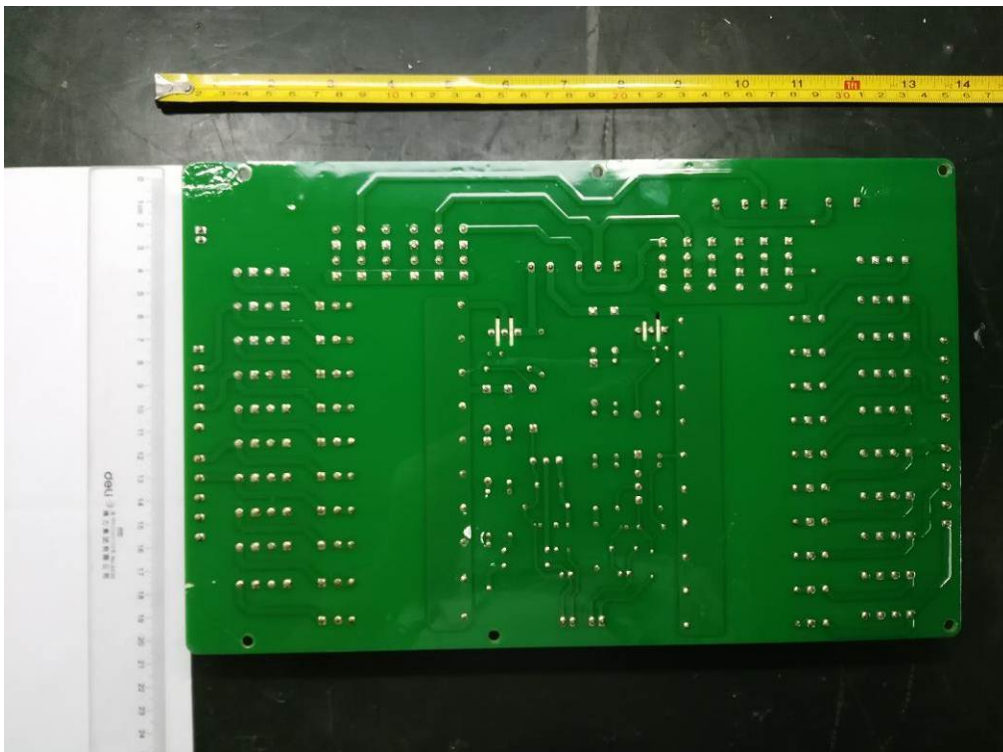

Fig. 9 – PCB view

Appendix 2
Product photos

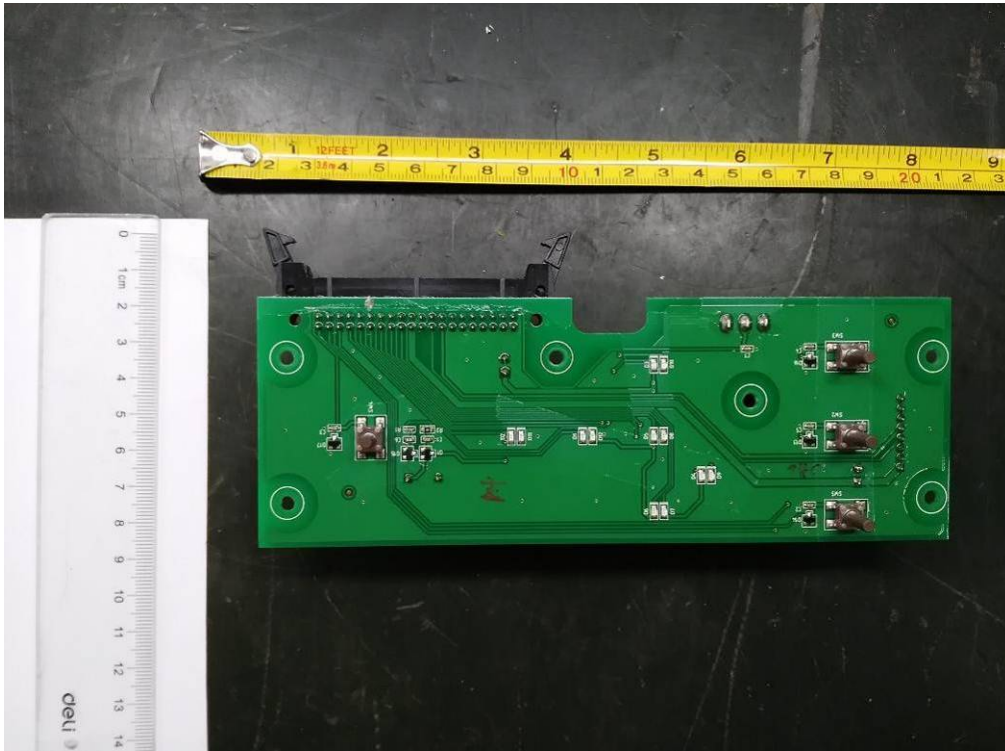

Fig. 10 – PCB view

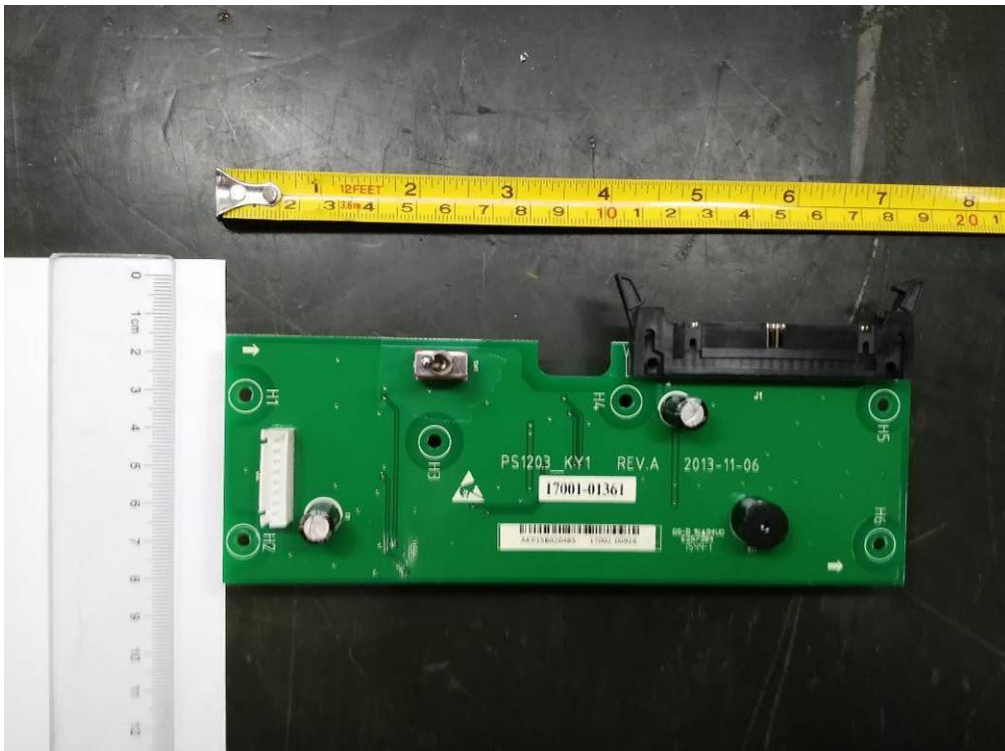

Fig. 11 – PCB view

Appendix 2
Product photos

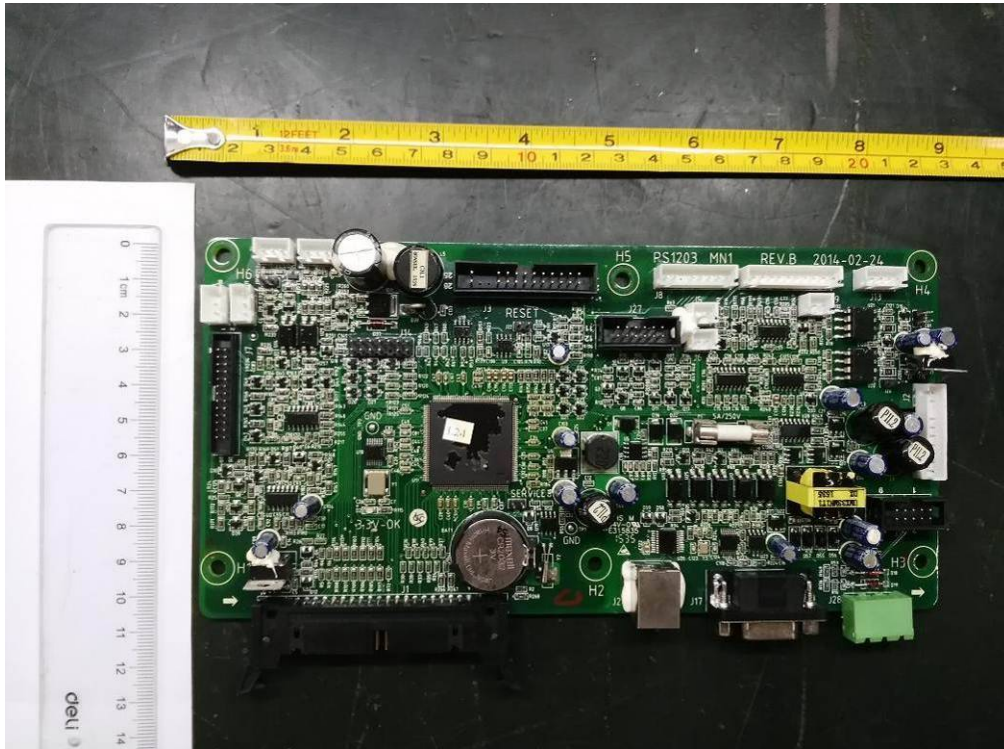

Fig. 12 –PCB view

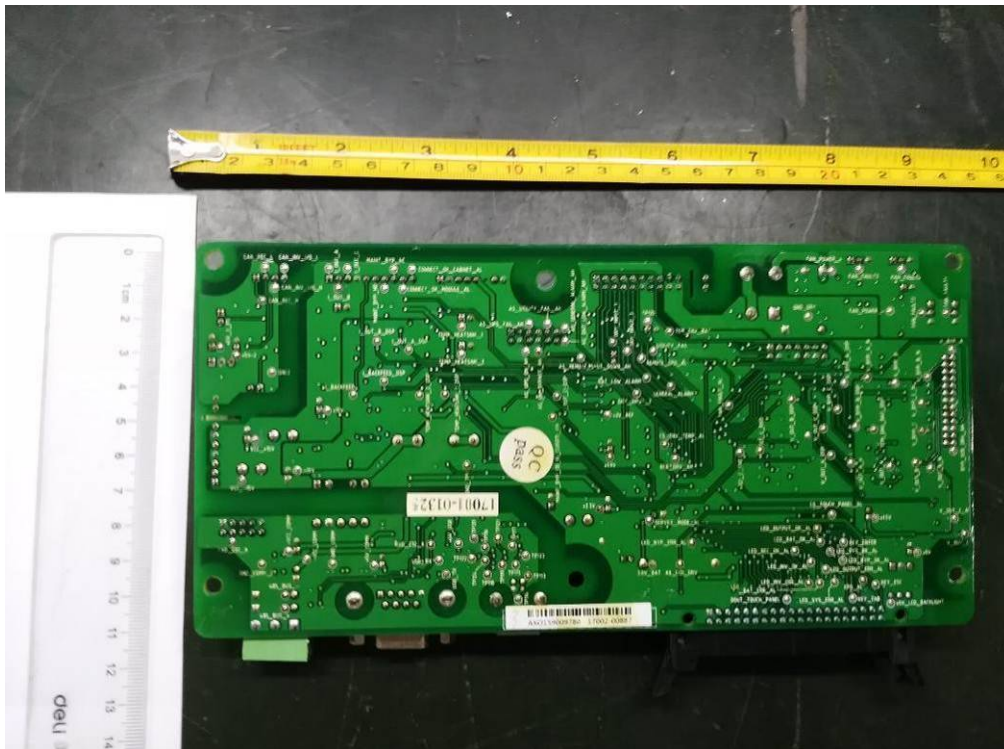

Fig. 13 – PCB view

Appendix 2
Product photos

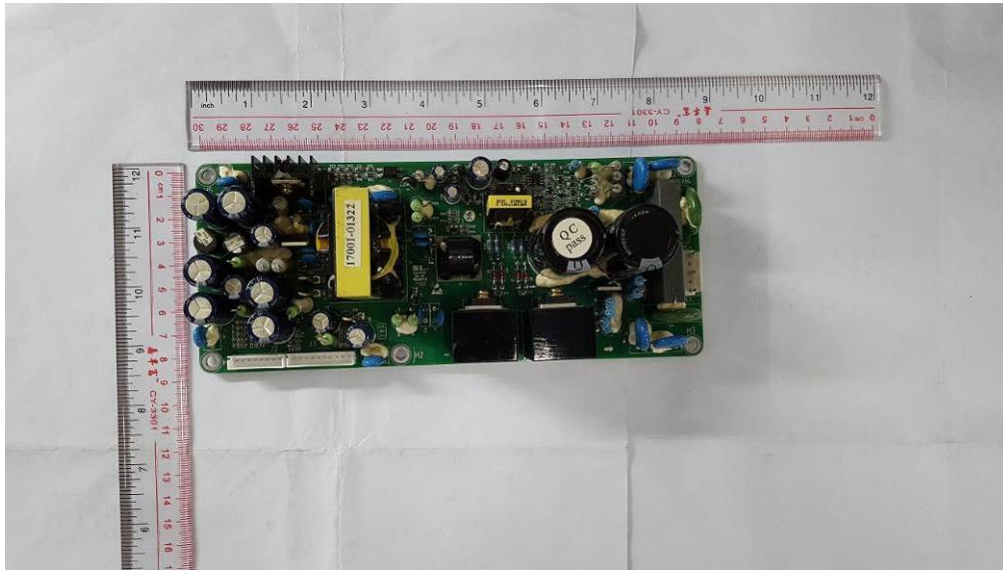

Fig. 14 –PCB view

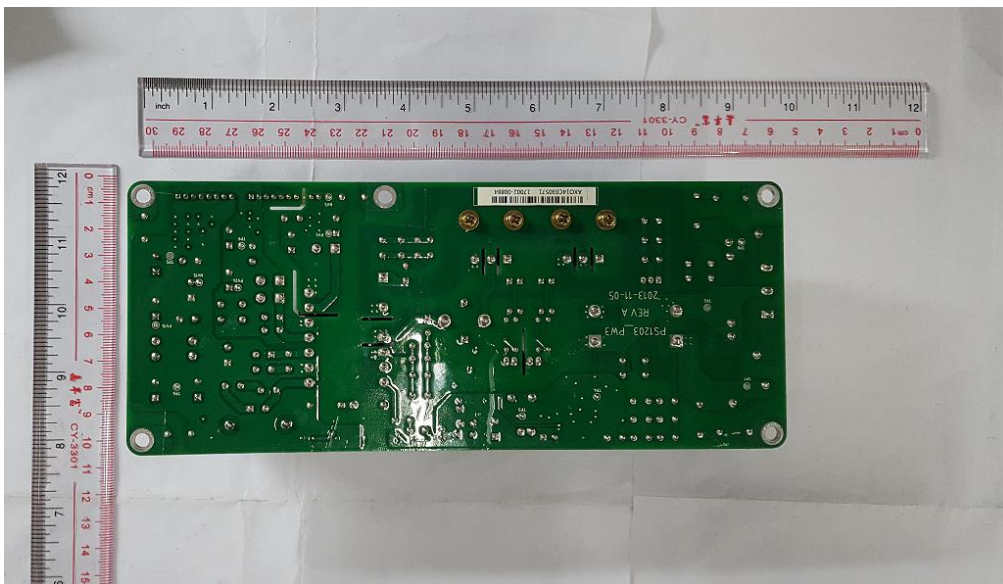

Fig. 15 – PCB view

Appendix 2
Product photos

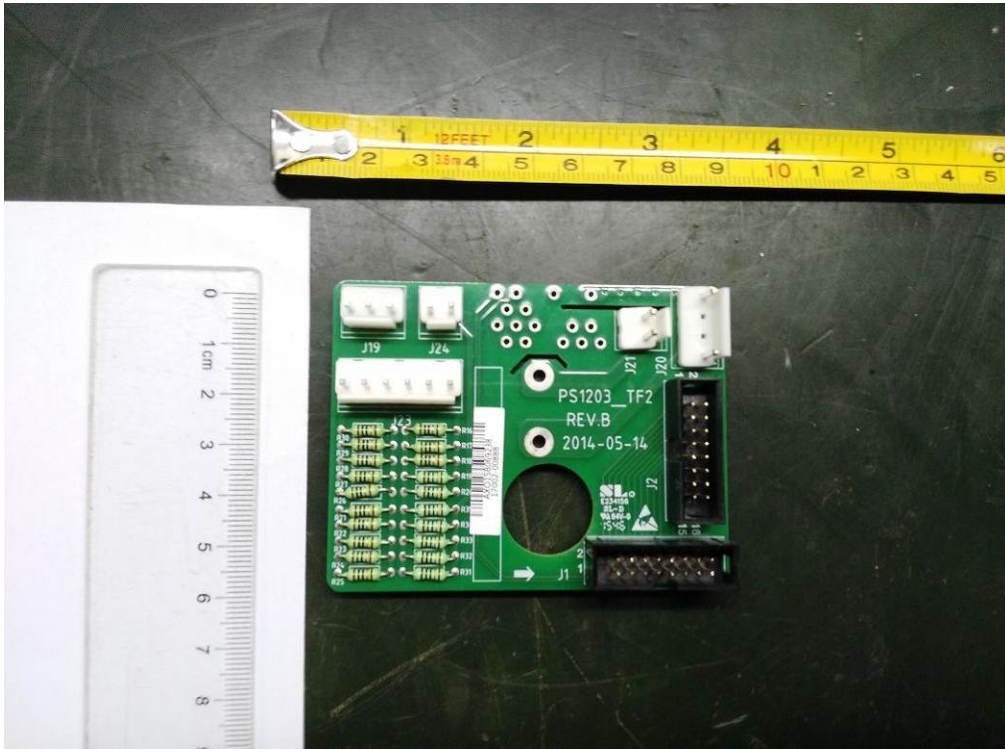

Fig. 16 –PCB view

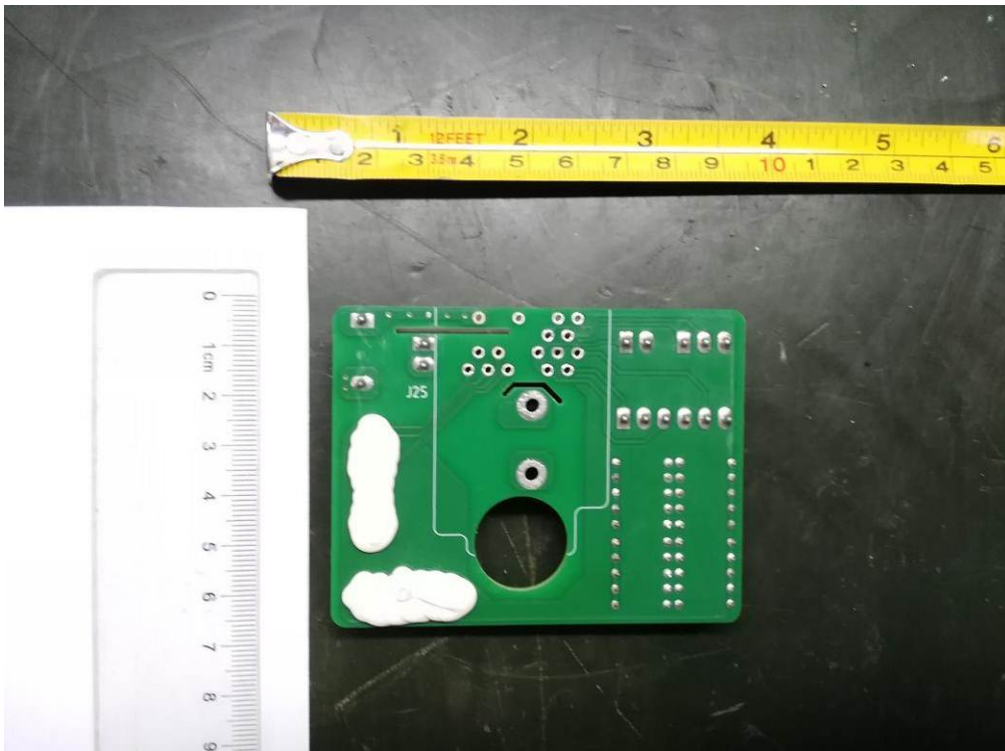

Fig. 17 – PCB view

Appendix 2
Product photos

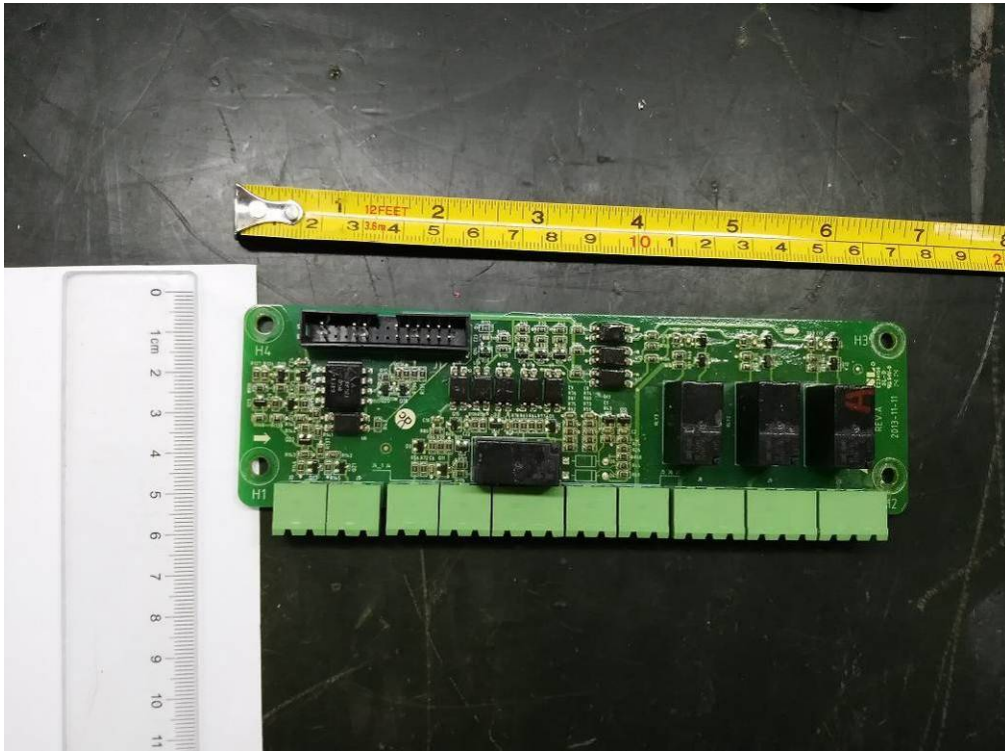

Fig. 18 –PCB view

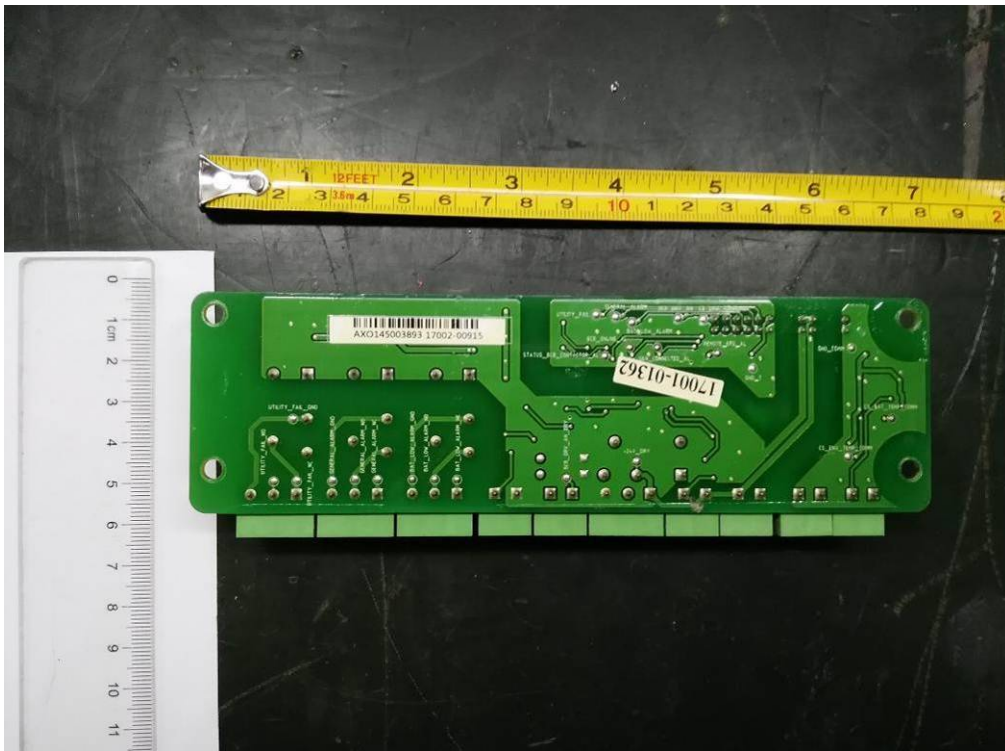

Fig. 19– PCB view

Appendix 2
Product photos

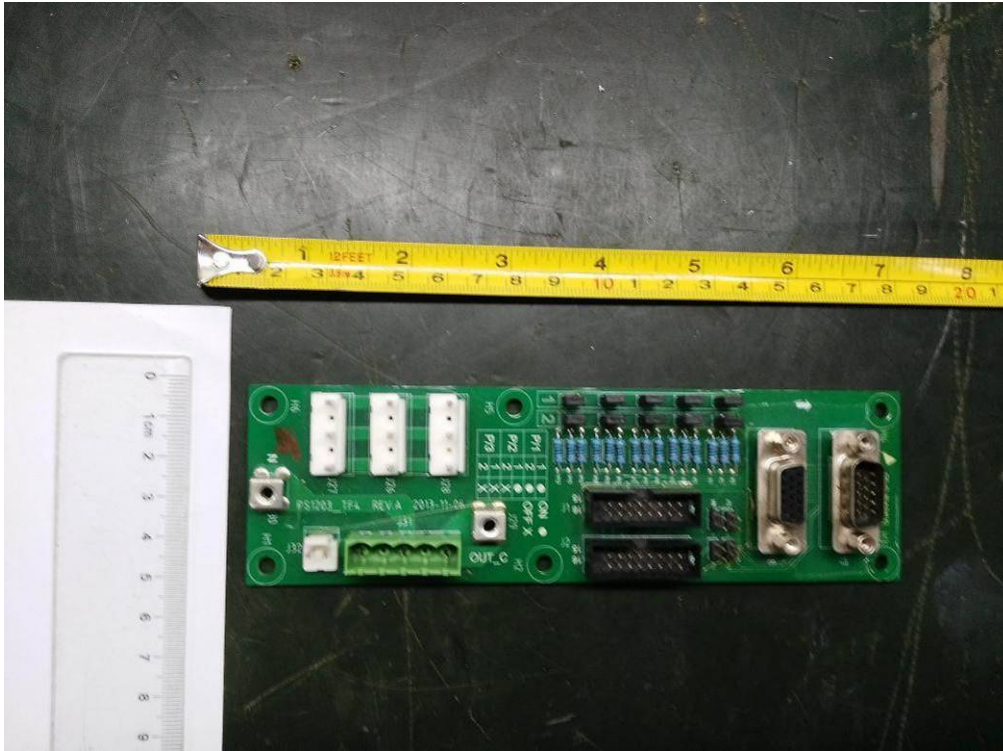

Fig. 20 – PCB view

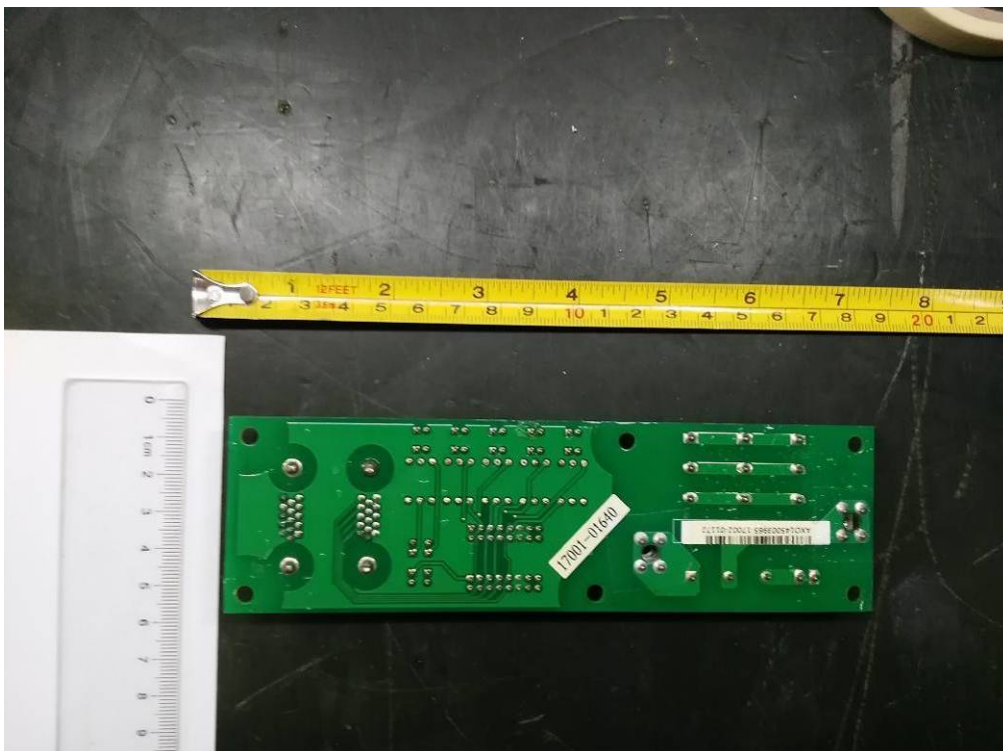

Fig. 21 – PCB view

Appendix 2
Product photos



Fig. 22 – PCB view



Fig. 23 – PCB view

Appendix 2
Product photos

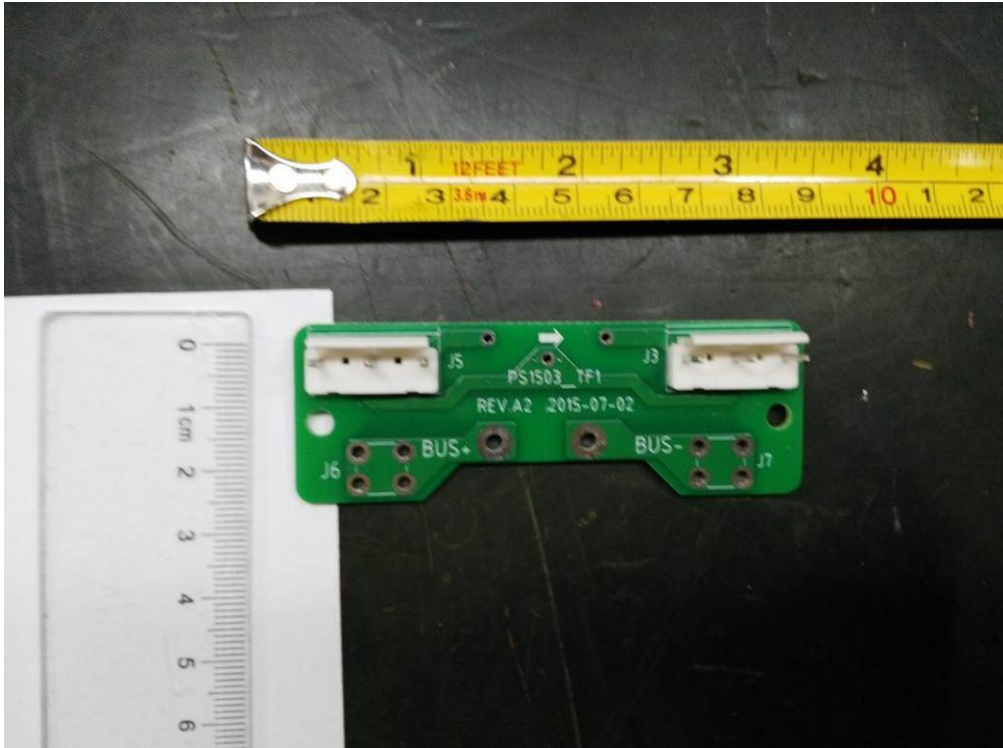

Fig. 24 – PCB view

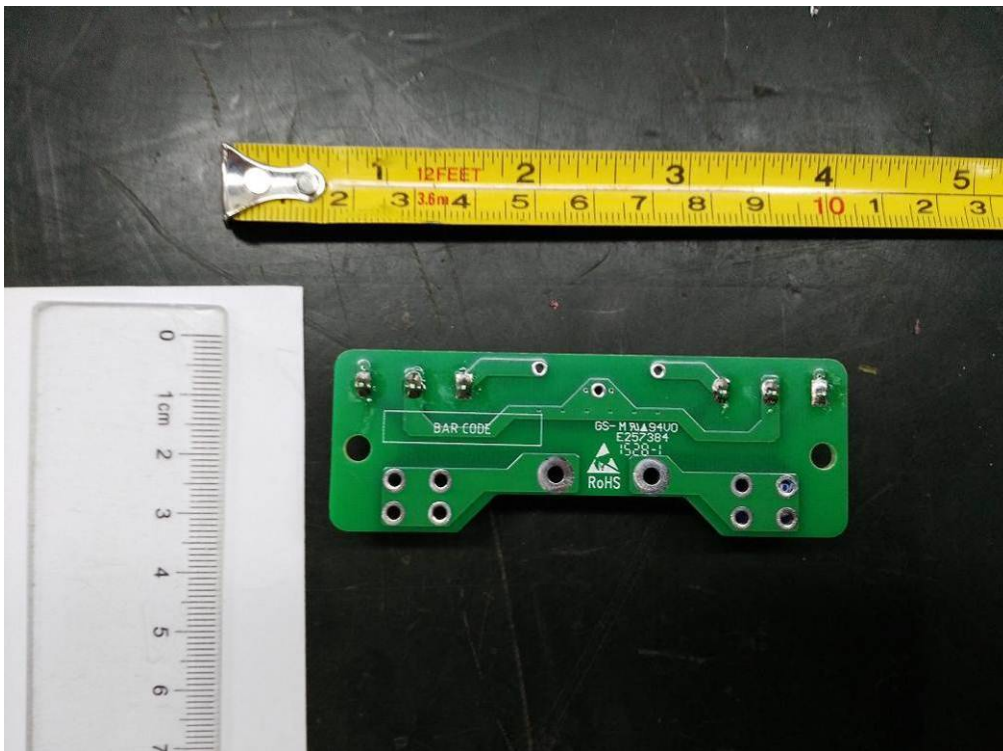

Fig. 25 – PCB view

Appendix 2
Product photos

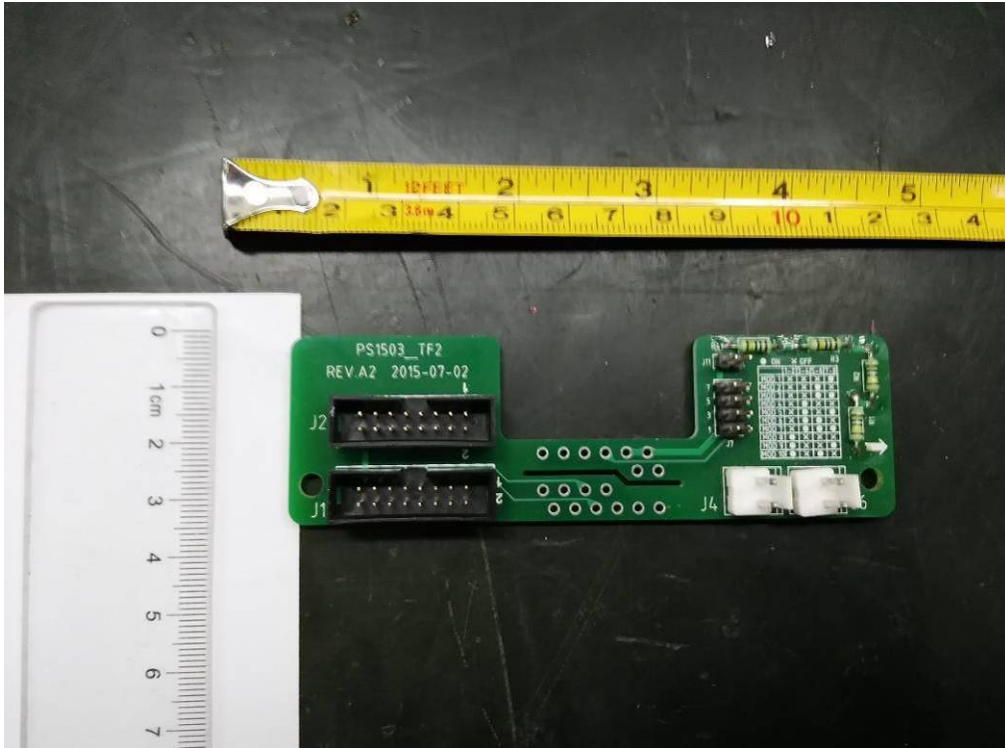

Fig. 26 – PCB view

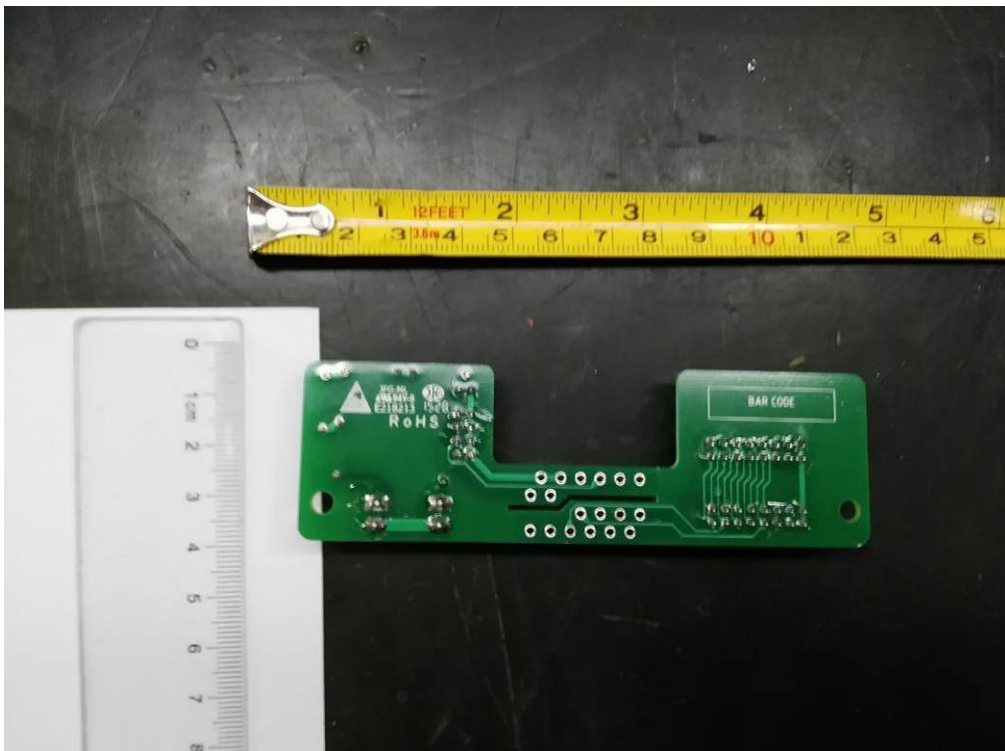

Fig. 27 – PCB view

Appendix 2
Product photos

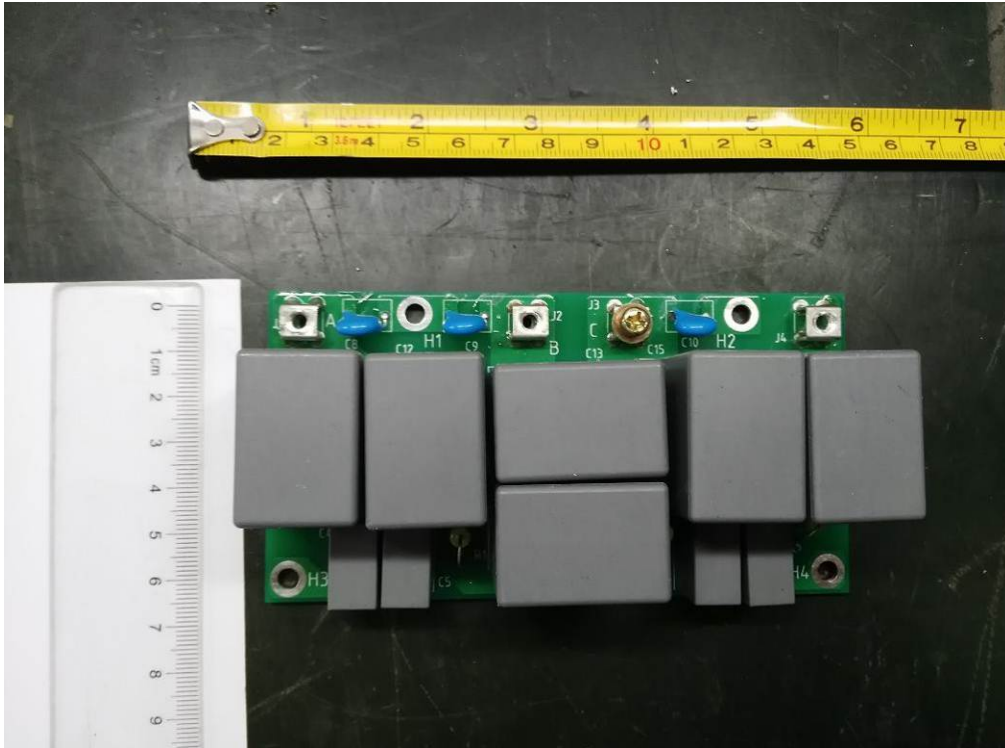

Fig. 28 – PCB view

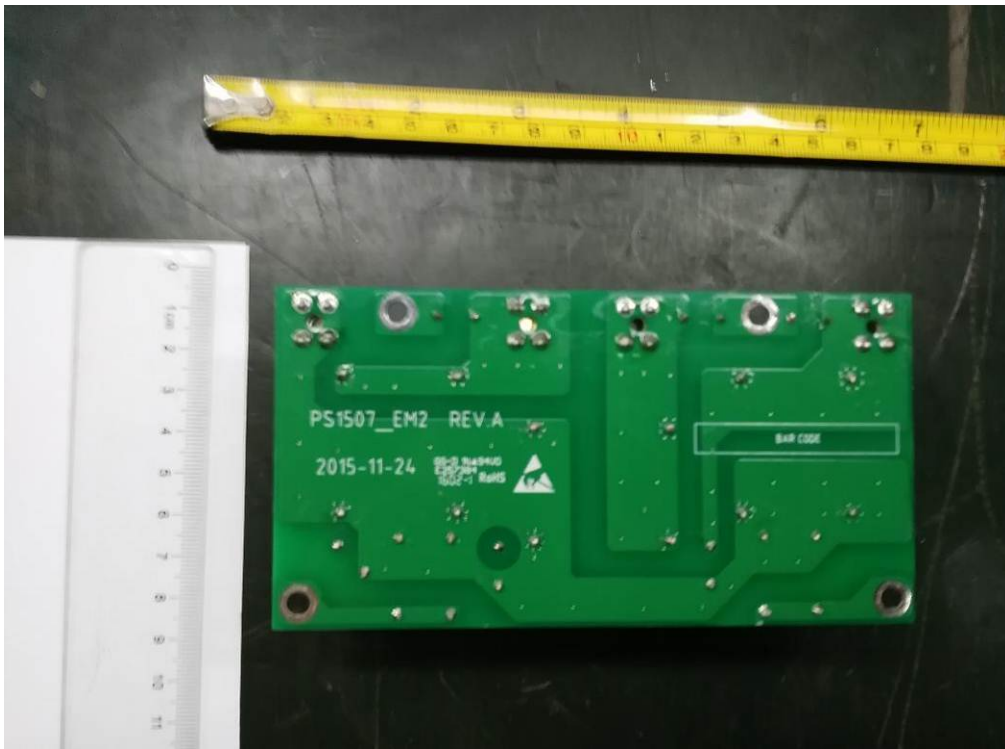

Fig. 29 – PCB view

Appendix 2
Product photos

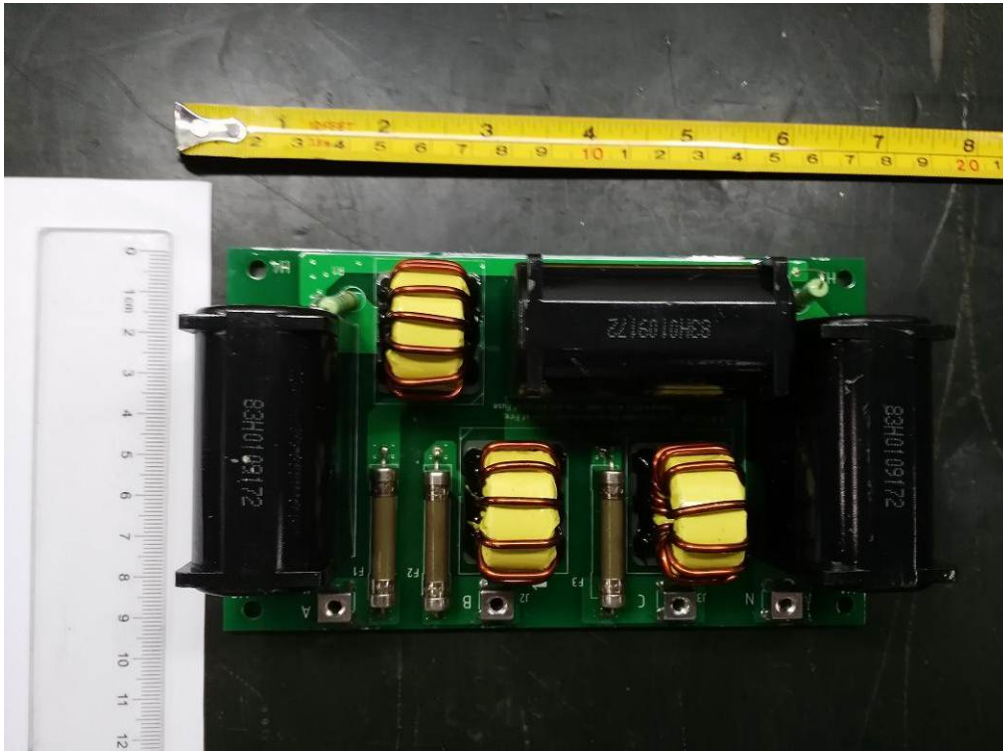

Fig. 30 – PCB view

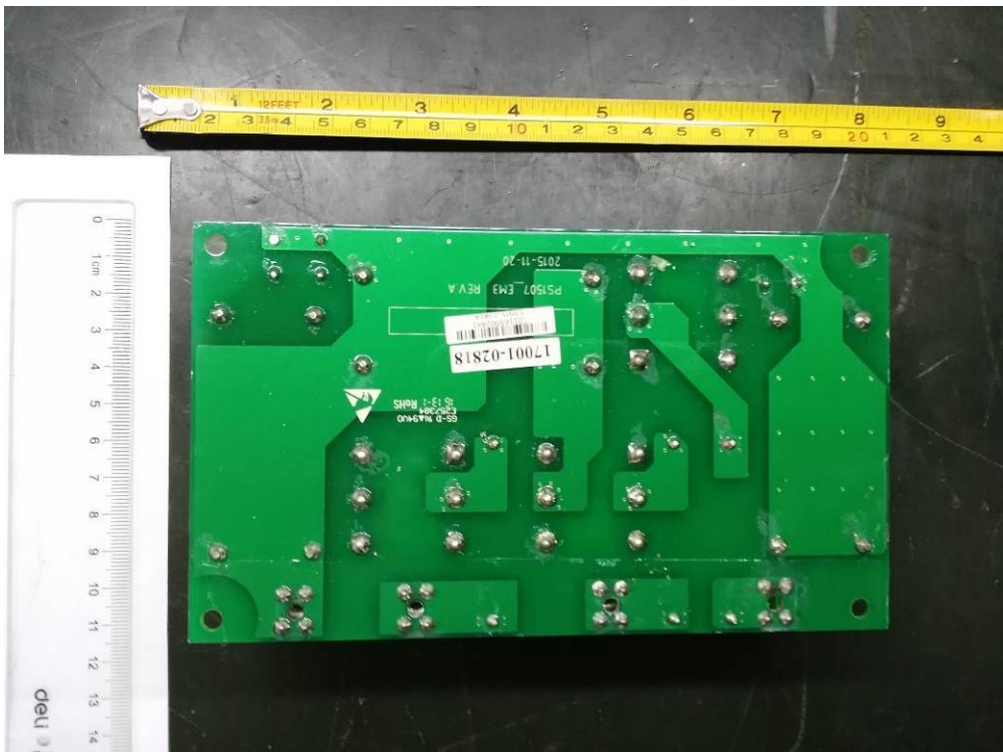

Fig. 31 – PCB view