

EMC TEST REPORT

For

INVT POWER SYSTEM (SHENZHEN) CO., LTD.

Uninterruptible Power Systems

Model No.: RM090/15X, RM060/10X, PM15X, RM045/15X

Prepared for : INVT POWER SYSTEM (SHENZHEN) CO., LTD.
Address : 5# Building, Gaofa Industrial Park, Longjing, Nanshan District,
Shenzhen, China, 518055

Prepared by : EMTEK (SHENZHEN) CO., LTD.
Address : Bldg 69, Majialong Industry Zone,
Nanshan District, Shenzhen, Guangdong, China

Tel: (0755) 26954280

Fax: (0755) 26954282

Report Number : ES16229036E
Date of Test : February 29, 2016 to March 11, 2016
Date of Report : March 12, 2016

TABLE OF CONTENT

Test Report Description	Page
1. SUMMARY OF TEST RESULT	5
2. GENERAL INFORMATION.....	8
2.1. Description of Device (EUT).....	8
2.2. Description of Support Device.....	8
2.3. Description of Test Facility	9
2.4. Measurement Uncertainty	9
3. MEASURING DEVICE AND TEST EQUIPMENT	10
3.1. For Power Line Conducted Emission	10
3.2. For 10m Radiated Emission Measurement	10
3.3. For Harmonic Current / Flicker Measurement.....	10
3.4. For Electrostatic Discharge Immunity Test.....	11
3.5. For RF Strength Susceptibility Test	11
3.6. For Electrical Fast Transient /Burst Immunity Test	11
3.7. For Surge Immunity Test	11
3.8. For Injected Current Susceptibility Test	11
3.9. For Magnetic Field Immunity Test	12
3.10. For Voltage Dips and Interruptions Test	12
3.11. Low Frequency Signals Test	12
4. POWER LINE CONDUCTED EMISSION MEASUREMENT	13
4.1. Block Diagram of Test Setup	13
4.2. Measuring Standard	13
4.3. EUT Configuration on Measurement.....	13
4.4. Operating Condition of EUT.....	14
4.5. Test Procedure.....	14
4.6. Measuring Results.....	14
5. RADIATED EMISSION MEASUREMENT.....	15
5.1. Block Diagram of Test	15
5.2. Measuring Standard	15
5.3. Radiated Emission Limits	16
5.4. EUT Configuration on Test.....	16
5.5. Operating Condition of EUT.....	16
5.6. Test Procedure.....	16
5.7. Measuring Results.....	16
6. HARMONIC CURRENT EMISSION MEASUREMENT.....	17
6.1. Block Diagram of Test Setup	17
6.2. Measuring Standard	17
6.3. Operation Condition of EUT.....	17
6.4. Measuring Results.....	17
7. VOLTAGE FLUCTUATION AND FLICKER MEASUREMENT	18
7.1. Block Diagram of Test Setup	18

7.2.	Measuring Standard	18
7.3.	Operation Condition of EUT.....	18
7.4.	Measuring Results.....	18
8.	ELECTROSTATIC DISCHARGE IMMUNITY TEST.....	19
8.1.	Block Diagram of Test Setup	19
8.2.	Test Standard.....	19
8.3.	Severity Levels and Performance Criterion	19
8.4.	EUT Configuration	20
8.5.	Operating Condition of EUT.....	20
8.6.	Test Procedure.....	20
8.7.	Test Results	20
9.	RF FIELD STRENGTH SUSCEPTIBILITY TEST	22
9.1.	Block Diagram of Test	22
9.2.	Test Standard.....	22
9.3.	Severity Levels and Performance Criterion	23
9.4.	EUT Configuration on Test.....	23
9.5.	Operating Condition of EUT.....	23
9.6.	Test Procedure.....	23
9.7.	Test Results	23
10.	ELECTRICAL FAST TRANSIENT/BURST IMMUNITY TEST	25
10.1.	Block Diagram of Test Setup	25
10.2.	Test Standard.....	25
10.3.	Severity Levels and Performance Criterion	25
10.4.	EUT Configuration	26
10.5.	Operating Condition of EUT.....	26
10.6.	Test Procedure.....	26
10.7.	Test Result.....	26
11.	SURGE IMMUNITY TEST	28
11.1.	Block Diagram of Test Setup	28
11.2.	Test Standard.....	28
11.3.	Severity Levels and Performance Criterion	28
11.4.	EUT Configuration	28
11.5.	Operating Condition of EUT.....	29
11.6.	Test Procedure.....	29
11.7.	Test Result.....	29
12.	INJECTED CURRENTS SUSCEPTIBILITY TEST	31
12.1.	Block Diagram of Test Setup	31
12.2.	Test Standard.....	31
12.3.	Severity Levels and Performance Criterion	31
12.4.	EUT Configuration	31
12.5.	Operating Condition of EUT.....	32
12.6.	Test Procedure.....	32
12.7.	Test Results	32
13.	MAGNETIC FIELD SUSCEPTIBILITY TEST	34
13.1.	Block Diagram of Test	34
13.2.	Test Standard.....	34
13.3.	Severity Levels and Performance Criterion	34

13.4.	EUT Configuration on Test	35
13.5.	Test Procedure.....	35
13.6.	Test Results	35
14.	VOLTAGE DIPS AND INTERRUPTIONS TEST	37
14.1.	Block Diagram of Test Setup	37
14.2.	Test Standard.....	37
14.3.	Severity Levels and Performance Criterion.....	37
14.4.	EUT Configuration	38
14.5.	Operating Condition of EUT.....	38
14.6.	Test Procedure.....	38
14.7.	Test Result.....	38
15.	LOW FREQUENCY SIGNALS TEST	40
15.1.	Block Diagram of Test Setup	40
15.2.	Test Standard.....	40
15.3.	Operating Condition of EUT.....	40
15.4.	Test Results	40
16.	PHOTOGRAPH.....	42
16.1.	Photo of Conducted Emission Measurement.....	42
16.2.	Photo of Radiation Emission Measurement.....	42
16.3.	Photo of RF Field Strength Susceptibility Test.....	46
16.4.	Photo of Surge Test	46

APPENDIX I (4 Pages)

APPENDIX II (4 Pages)

APPENDIX III (Photos of EUT) (19 Pages)

TEST REPORT DESCRIPTION

Applicant : INVT POWER SYSTEM (SHENZHEN) CO., LTD.
 Manufacturer : INVT POWER SYSTEM (SHENZHEN) CO., LTD.
 Trademark : INVT
 EUT : Uninterruptible Power Systems
 (A) Model No. : RM090/15X, RM060/10X, PM15X, RM045/15X
 (B) Power Supply:
 AC Input: 380VAC, 143/95/24A
 Batt. Input: 380VAC, 136/91/22.7A

Measurement Procedure Used:

EN62040-2: 2006
 (EN61000-4-2:2009, EN61000-4-3:2006+A1:2008+A2:2010, EN61000-4-4: 2012, EN61000-4-5: 2014,
 EN61000-4-6: 2014, EN61000-4-8: 2010, EN61000-4-11: 2004, EN61000-2-2: 2006 EN61000-3-12: 2011,
 EN 61000-3-11: 2000)

The device described above is tested by EMTEK (SHENZHEN) CO., LTD. to determine the maximum emission levels emanating from the device and the severe levels of the device can endure and its performance criterion. The measurement results are contained in this test report and EMTEK (SHENZHEN) CO., LTD. is assumed full of responsibility for the accuracy and completeness of these measurements. Also, this report shows that the EUT (Equipment Under Test) is technically compliant with the EN 62040-2 requirements.

This report applies to above tested sample only and shall not be reproduced in part without written approval of EMTEK (SHENZHEN) CO., LTD.

Date of Test : February 29, 2016 to March 11, 2016

Prepared by : 
 Vern Fan/Editor

Reviewer : 
 Jessie Hu/Supervisor

Approved & Authorized Signer : 
 Lisa Wang/Manager

Modified Information

Version	Report No.	Revision Date	Summary
Ver.1.0	ES16229036E	/	Original Version

1. SUMMARY OF TEST RESULT

EMISSION			
Description of test item	Standard	Limits	Results
Conducted disturbance at mains terminals	EN62040-2: 2006	C3	Pass
Radiated Disturbance	EN62040-2: 2006	C3	Pass
Harmonic current emissions	EN61000-3-12:2011	Class A	N/A
Voltage fluctuation and flicker	EN 61000-3-11: 2000	-	N/A
Immunity			
Description of test item	Basic Standard	Performance Criteria	Results
Electrostatic Discharge (ESD)	EN61000-4-2: 2009	B	Pass
Radio-frequency, Continuous radiated disturbance	EN61000-4-3: 2006+A1:2008+A2:2010	A	Pass
EFT/B Immunity	EN61000-4-4: 2012	B	Pass
Surge Immunity	EN61000-4-5: 2014	B	Pass
Conducted RF Immunity	EN61000-4-6: 2014	A	Pass
Power frequency magnetic field	EN61000-4-8: 2010	A	Pass
Voltage dips and Voltage interruptions	EN61000-4-11:2004	A	Pass
Low Frequency signals	EN61000-2-2: 2006	A	Pass
Note: N/A is an abbreviation for Not Applicable.			

2. GENERAL INFORMATION

2.1. Description of Device (EUT)

EUT : Uninterruptible Power Systems

Model Number : RM090/15X, RM060/10X, PM15X, RM045/15X
(Note: All the modes have the same PCB and circuit diagram, only differences are the output current, input current and rating power. We take RM090/15X for test.)

Test Voltage : AC 380V/50Hz

Applicant : INVT POWER SYSTEM (SHENZHEN) CO., LTD.

Address : 5# Building, Gaofa Industrial Park, Longjing, Nanshan District, Shenzhen, China, 518055

Manufacturer : INVT POWER SYSTEM (SHENZHEN) CO., LTD.

Address : 5# Building, Gaofa Industrial Park, Longjing, Nanshan District, Shenzhen, China, 518055

Date of receiver : February 29, 2016

Date of Test : February 29, 2016 to March 11, 2016

2.2. Description of Support Device

N/A

2.3. Description of Test Facility

Site Description

EMC Lab. : Accredited by CNAS, 2013.10.29
 The certificate is valid until 2016.10.28
 The Laboratory has been assessed and proved to be in compliance with CNAS-CL01:2006(identical to ISO/IEC17025:2005)
 The Certificate Registration Number is L2291.

Accredited by TUV Rheinland Shenzhen 2010.5.25
 The Laboratory has been assessed according to the requirements ISO/IEC 17025.

Accredited by FCC, October 17, 2013
 The Certificate Registration Number is 709623.

Accredited by Industry Canada, November 29, 2012
 The Certificate Registration Number is 4480A.

Name of Firm : EMTEK (SHENZHEN) CO., LTD.
 Site Location : Bldg 69, Majialong Industry Zone,
 Nanshan District, Shenzhen, Guangdong, China

2.4. Measurement Uncertainty

Test Item	Uncertainty
Conducted Emission Uncertainty	: 3.16dB(9k~150kHz Conduction 2#) 2.90dB(150k-30MHz Conduction 2#)
Power clamp	: 2.53dB
Uncertainty for Flicker test	: 0.07%
Uncertainty for Harmonic test	: 1.8%
Uncertainty for C/S Test	: 1.45(Using CDN Test)
Uncertainty for test site temperature and humidity	: 0.6°C 4%

3. MEASURING DEVICE AND TEST EQUIPMENT

3.1. For Power Line Conducted Emission

Item	Equipment	Manufacturer	Model No.	Serial No.	Last Cal.	Cal. Interval
1.	Test Receiver	Rohde & Schwarz	ESCS30	828985/018	May 16, 2015	1 Year
2.	L.I.S.N	Rohde & Schwarz	ESH2-Z5	834549/005	May 16, 2015	1 Year
3.	50Ω Coaxial Switch	Anritsu	MP59B	M20531	N/A	N/A
4.	Pulse Limiter	Rohde & Schwarz	ESH3-Z2	100006	May 16, 2015	1 Year
5.	Voltage Probe	Rohde & Schwarz	TK9416	N/A	May 16, 2015	1 Year

3.2. For 10m Radiated Emission Measurement

Item	Equipment	Manufacturer	Model No.	Serial No.	Last Cal.	Cal. Interval
1	EMI Test Receiver	Rohde & Schwarz	ESR3	1316.3003K03-1 01706-HN	May 16, 2015	1 Year
2	EMI Test Receiver	Rohde & Schwarz	ESR3	1316.3003K03-1 01707-Z1	May 16, 2015	1 Year
3	Pre-Amplifier	Lunar EM	LNA10M1G-40	J1011130912001	May 16, 2015	1 Year
4	Pre-Amplifier	Lunar EM	LNA10M1G-40	J1011131126002	May 16, 2015	1 Year
5	Bilog Antenna	Schwarzbeck	VULB9163	659	Sep. 2, 2015	1 Year
6	Bilog Antenna	Schwarzbeck	VULB9163	661	May 16, 2015	1 Year
7	Cable	Times Microwave	LMR-240 N-N 1m	SS26-P1	May 16, 2015	
8	Cable	Times Microwave	LMR-240 N-N 1m	SS26-P2	May 16, 2015	1 Year
9	Cable	Times Microwave	LMR-240 N-N 1.5m		May 16, 2015	1 Year
10	Cable	Times Microwave	LMR-240 N-N 1.5m		May 16, 2015	1 Year
11	Cable	Times Microwave	LMR-240 N-N 12m		May 16, 2015	1 Year
12	Cable	Times Microwave	LMR-240 N-N 11m		May 16, 2015	1 Year

3.3. For Harmonic Current / Flicker Measurement

Item	Equipment	Manufacturer	Model No.	Serial No.	Last Cal.	Cal. Interval
1.	AC Power source	California Instruments	5001iX-CT S-400-413	72795	May 16, 2015	1 Year

3.4.For Electrostatic Discharge Immunity Test

Item	Equipment	Manufacturer	Model No.	Serial No.	Last Cal.	Cal. Interval
1.	ESD Tester	TESEQAG	NSG 437	000409	May 16, 2015	1 Year

3.5.For RF Strength Susceptibility Test

Item	Equipment	Manufacturer	Model No.	Serial No.	Last Cal.	Cal. Interval
1.	RF Power Meter. Dual Channel	BOONTON	4232A	10539	May 16, 2015	1 Year
2.	50ohm Diode Power Sensor	BOONTON	51011EMC	34236/34238	May 16, 2015	1 Year
3.	Broad-Band Horn Antenna	SCHWARZB ECK	BBHA 9120 L3F	332	May 16, 2015	1 Year
4.	Power Amplifier	PRANA	AP32MT215	N/A	May 16, 2015	1 Year
5.	Power Amplifier	MILMEGA	AS0102-55	N/A	May 16, 2015	1 Year
6.	Signal Generator	AEROFLEX	2023B	N/A	May 16, 2015	1 Year
7.	Field Strength Meter	HOLADAY	HI-6005	N/A	May 16, 2015	1Year
8.	RS232 Fiber Optic Modem	HOLADAY	HI-4413P	N/A	May 16, 2015	1 Year
9.	Log.-Per. Antenna	SCHWARZB ECK	VULP 9118E	N/A	May 16, 2015	1 Year

3.6.For Electrical Fast Transient /Burst Immunity Test

Item	Equipment	Manufacturer	Model No.	Serial No.	Last Cal.	Cal. Interval
1.	Burst Tester	HAEFELY	PEFT4010	080981-16	May 16, 2015	1Year
2.	Coupling Clamp	HAEFELY	IP-4A	147147	May 16, 2015	1Year

3.7.For Surge Immunity Test

Item	Equipment	Manufacturer	Model No.	Serial No.	Last Cal.	Cal. Interval
1	Surge Controller	HAEFELY	Psurge 8000	174031	May 16, 2015	1Year
2	Impulse Module	HAEFELY	PIM 100	174124	May 16, 2015	1Year
3	Coupling Decoupling Filter	HAEFELY	PCD 130	172181	May 16, 2015	1Year
4	Coupling Module	HAEFELY	PCD122	174354	May 16, 2015	1Year
5	Surge Impulse Module	HAEFELY	PIM 120	174435	May 16, 2015	1Year
6	Coupling Module	HAEFELY	PCD 126A	174387	May 16, 2015	1Year
7	Impulse Module	HAEFELY	PIM 110	174391	May 16, 2015	1Year
8	Impulse Module	HAEFELY	PIM 150	178707	May 16, 2014	1Year

3.8.For Injected Current Susceptibility Test

Item	Equipment	Manufacturer	Model No.	Serial No.	Last Cal.	Cal. Interval
1	Simulator	FRANKONIA	CIT-10	126B12101 2012	May 16, 2015	1 Year
2	CDN	EMTEST	CDN-M2	5100100100	May 16, 2015	1 Year
3	CDN	EMTEST	CDN-M3	0900-11	May 16, 2015	1 Year
4	Injection Clamp	EMTEST	F-2031-23M M	368	May 16, 2015	1 Year
5	Attenuator	EMTEST	ATT6	0010222A	May 16, 2015	1 Year
6	Three phase CDN	Teseq	CDN M332S	32655	May 16, 2015	1 Year
7	Three phase CDN	Teseq	CDN M432S	33670	May 16, 2015	1 Year
8	Three phase CDN	Teseq	CDN M432-3LNS	34048	May 16, 2015	1 Year
9	Three phase CDN	Teseq	CDN M532S	33799	May 16, 2015	1 Year
10	Bulk Current Injection Probe	FCC	F-120-9	140302	May 16, 2015	1 Year

3.9.For Magnetic Field Immunity Test

Item	Equipment	Manufacturer	Model No.	Serial No.	Last Cal.	Cal. Interval
1.	Magnetic Field Tester	HAEFELY	MAG100	250040.1	May 16, 2015	1 Year

3.10.For Voltage Dips and Interruptions Test

Item	Equipment	Manufacturer	Model No.	Serial No.	Last Cal.	Cal. Interval
1.	Dips Tester	HAEFELY	Pline1610	083732-12	May 16, 2015	1 Year

3.11.Low Frequency Signals Test

Item	Equipment	Manufacturer	Model No.	Serial No.	Last Cal.	Cal. Interval
1.	Programmable AC Source	CHROMA	6530	/	May 16, 2015	1 Year

4. POWER LINE CONDUCTED EMISSION MEASUREMENT

4.1. Block Diagram of Test Setup

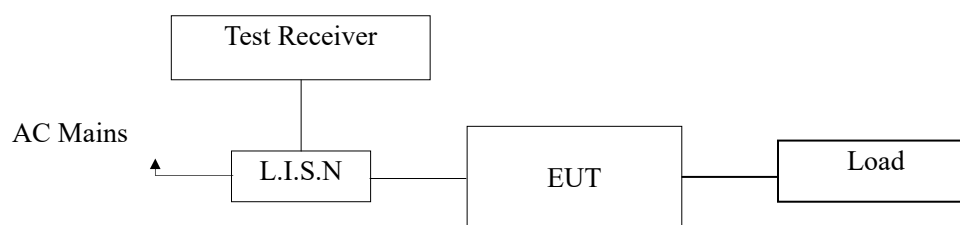

(EUT: Uninterruptible Power Systems)

4.2. Measuring Standard

EN62040-2: 2006 Category C3

Power Line Conducted Emission Limits (C3)

UPS rated output current A	Frequency range MHz	Limits dB (μV)	
		Quasi-peak	Average
>16 – 100	0,15 to 0,50 ^b	100	90
	0,50 to 5,0 ^b	86	76
	5,0 to 30,0	90 to 70 ^a	80 to 60 ^a
>100	0,15 to 0,50 ^b	130	120
	0,50 to 5,0 ^b	125	115
	5,0 to 30,0	115	105

^a The limits decrease linearly with the logarithm of the frequency.
^b The lower limit shall apply at the transition frequency.

4.3. EUT Configuration on Measurement

The following equipments are installed on Conducted Emission Measurement to meet EN62040-2 requirements and operating in a manner which tends to maximize its emission characteristics in a normal application.

EUT : Uninterruptible Power Systems
 Model Number : RM090/15X
 Serial Number : N/A

4.4. Operating Condition of EUT

4.4.1. Setup the EUT as shown on Section 4.1.

4.4.2. Turn on the power of all equipments.

4.4.3. Let the EUT work in measuring mode (AC mode/Battery mode) and measure it.

4.5. Test Procedure

The EUT is put on the plane 0.8m high above the ground by insulating support and connected to the AC mains through Line Impedance Stability Network (L.I.S.N). This provided a 50ohm coupling impedance for the tested equipments. Both sides of AC line are investigated to find out the maximum conducted emission according to the EN62040-2 regulations during conducted emission measurement.

The bandwidth of the field strength meter (R&S Test Receiver ESCS30) is set at 9KHz in 150KHz~30MHz and 200Hz in 9KHz~150KHz.

The frequency range from 150kHz to 30MHz is investigated

All the scanning waveform is put in Appendix I.

4.6. Measuring Results

PASS.

Please reference to the following page.

5. RADIATED EMISSION MEASUREMENT

5.1. Block Diagram of Test

5.1.1. Block diagram of connection between the EUT and simulators.



(EUT: Uninterruptible Power Systems)

5.1.2. Block diagram of test setup (In chamber)

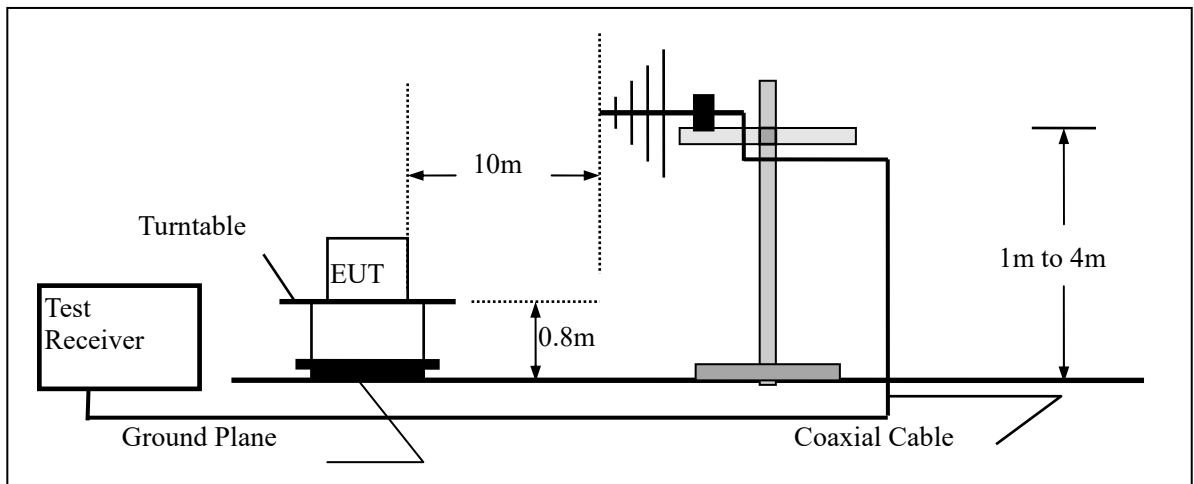

(EUT: Uninterruptible Power Systems)

5.2. Measuring Standard

EN62040-2: 2006 Category C3

5.3.Radiated Emission Limits

EN62040-2: 2006 Category C3 Limits:

All emanations from a C3 device or system, including any network of conductors and apparatus connected thereto, shall not exceed the level of field strengths specified below:

FREQUENCY (MHz)	DISTANCE (Meters)	FIELD STRENGTHS LIMIT (dB μ V/m)
30 ~ 230	10	50
230 ~ 1000	10	60

- Note:
- (1) The smaller limit shall apply at the combination point between two frequency bands.
 - (2) Distance refers to the distance in meters between the measuring instrument antenna and the closed point of any part of the EUT.

5.4.EUT Configuration on Test

The EN62040-2 regulations test method must be used to find the maximum emission during radiated emission measurement.

5.5.Operating Condition of EUT

5.5.1.Turn on the power.

5.5.2.After that, let the EUT work in test mode (AC mode/Battery mode) and measure it.

5.6.Test Procedure

The EUT is placed on a turn table which is 0.8 meter high above the ground. The turn table can rotate 360 degrees to determine the position of the maximum emission level. The EUT is set 10 meters away from the receiving antenna which is mounted on a antenna tower. The antenna can be moved up and down from 1 to 4 meters to find out the maximum emission level. Bilog antenna (calibrated by Dipole Antenna) is used as a receiving antenna. Both horizontal and vertical polarization of the antenna are set on test.

The bandwidth of the Receiver is set at 120kHz.
All the scanning curves are attached in Appendix II.

5.7.Measuring Results

PASS.

The frequency range from 30MHz to 1000MHz is investigated.

Please reference to Appendix II.

6. HARMONIC CURRENT EMISSION MEASUREMENT

6.1. Block Diagram of Test Setup

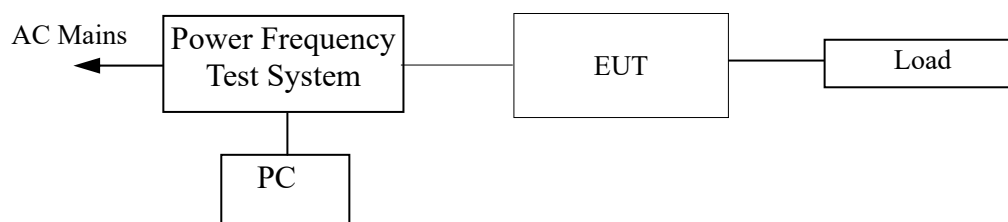

(EUT: Uninterruptible Power Systems)

6.2. Measuring Standard

EN61000-3-12: 2005+A2:2009 CLASS A

6.3. Operation Condition of EUT

Same as Section 4.4, except the test setup replaced as Section 6.1.

6.4. Measuring Results

Not Applicable.

7. VOLTAGE FLUCTUATION AND FLICKER MEASUREMENT

7.1. Block Diagram of Test Setup

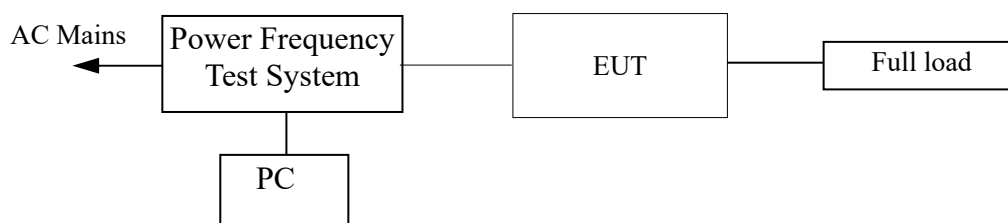

(EUT: Uninterruptible Power Systems)

7.2. Measuring Standard

EN 61000-3-11: 2000

7.3. Operation Condition of EUT

Same as Section 4.4, except the test setup replaced as Section 7.1.

7.4. Measuring Results

Not Applicable.

8. ELECTROSTATIC DISCHARGE IMMUNITY TEST

8.1. Block Diagram of Test Setup

8.1.1. Block diagram of connection between the EUT and simulators.



(EUT: Uninterruptible Power Systems)

8.1.2. Block diagram of ESD test setup

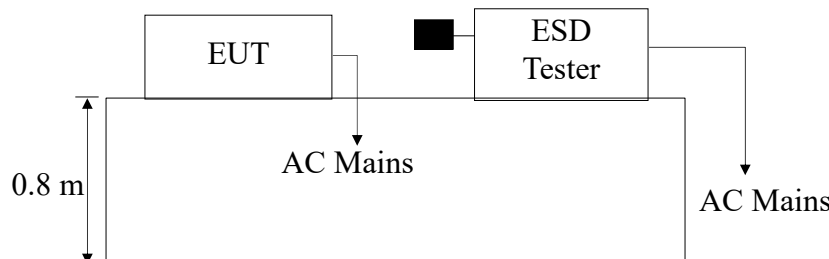

(EUT: Uninterruptible Power Systems)

8.2. Test Standard

EN62040-2:2006
(EN61000-4-2: 2009 Severity Level: 3 / Air Discharge: $\pm 8\text{KV}$
Level: 2/ Contact Discharge: $\pm 4\text{KV}$)

8.3. Severity Levels and Performance Criterion

8.3.1. Severity level

Level	Test Voltage Contact Discharge (KV)	Test Voltage Air Discharge (KV)
1.	± 2	± 2
2.	± 4	± 4
3.	± 6	± 8
4.	± 8	± 15
X	Special	Special

8.3.2. Performance criterion: A

8.4.EUT Configuration

The configuration of EUT is listed in Section 4.3.

8.5.Operating Condition of EUT

Same as conducted emission measurement, which is listed in Section 4.4. Except the test set up replaced by Section 8.1.

8.6.Test Procedure

8.6.1.Air Discharge:

This test is done on a non-conductive surface. The round discharge tip of the discharge electrode shall be approached as fast as possible to touch the EUT. After each discharge, the discharge electrode shall be removed from the EUT. The generator is then re-triggered for a new single discharge and repeated 10 times for each pre-selected test point. This procedure shall be repeated until all the air discharge completed.

8.6.2.Contact Discharge:

All the procedure shall be same as Section 8.6.1. Except that the tip of the discharge electrode shall touch the EUT before the discharge switch is operated.

8.6.3.Indirect discharge for horizontal coupling plane

At least 10 single discharges (in the most sensitive polarity) shall be applied at the front edge of each HCP opposite the center point of each unit (if applicable) of the EUT and 0.1m from the front of the EUT. The long axis of the discharge electrode shall be in the plane of the HCP and perpendicular to its front edge during the discharge.

8.6.4.Indirect discharge for vertical coupling plane

At least 10 singles discharge (in the most sensitive polarity) shall be applied to the center of one vertical edge of the coupling plane. The coupling plane, of dimensions 0.5m X 0.5m, is placed parallel to, and positioned at a distance of 0.1m from the EUT. Discharges shall be applied to the coupling plane, with this plane in sufficient different positions that the four faces of the EUT are completely illuminated.

8.7.Test Results

PASS

Please refer to the following pages

Electrostatic Discharge Test Result

EMTEK (SHENZHEN) CO., LTD.

Applicant	: INVT POWER SYSTEM (SHENZHEN) CO., LTD.	
EUT	: Uninterruptible Power Systems	Test Date : March 10, 2011
M/N	: RM090/15X	Temperature : 22°C
Power Supply	: AC 380V / 50Hz	Humidity : 50%
Air discharge	: ± 8.0KV	Test Mode : AC mode/Battery mode
Contact discharge:	± 4.0KV	Criterion : B
Location	Kind A-Air Discharge C-Contact Discharge	Result
Screen	A	PASS
Metal	C	PASS
Screw	C	PASS
Slot	A	PASS
HCP	C	PASS
VCP of front	C	PASS
VCP of rear	C	PASS
VCP of left	C	PASS
VCP of right	C	PASS
Test Equipment: ESD Simulator (EMTEST, ESD30C)		

9. RF FIELD STRENGTH SUSCEPTIBILITY TEST

9.1. Block Diagram of Test

9.1.1. Block diagram of connection between the EUT and simulators.



(EUT: Uninterruptible Power Systems)

9.1.2. Block diagram of RS test setup

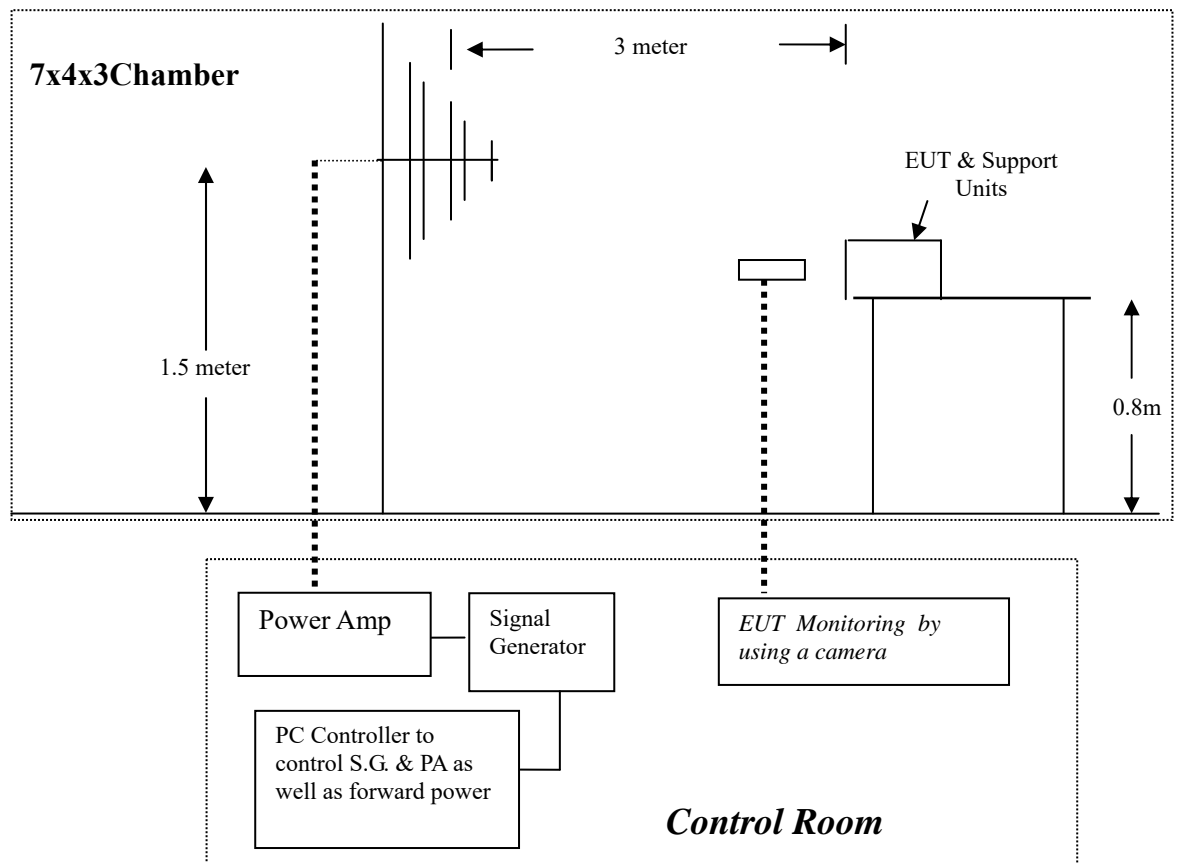

(EUT: Uninterruptible Power Systems)

9.2. Test Standard

EN62040-2:2006 (EN61000-4-3: 2006+A1:2008+A2:2010, Severity Level: 3, 10V / m)

9.3. Severity Levels and Performance Criterion

9.3.1. Severity Levels

Level	Field Strength V/m
1.	1
2.	3
3.	10
X	Special

9.3.2. Performance Criterion: A

9.4. EUT Configuration on Test

The configuration of the EUT is same as Section 4.3.

9.5. Operating Condition of EUT

Same as radiated emission measurement that is listed in Section 4.4, except the test setup replaced as Section 9.1.

9.6. Test Procedure

The EUT are placed on a table that is 0.8 meter high above the ground. The EUT is set 3 meters away from the transmitting antenna that is mounted on an antenna tower. Both horizontal and vertical polarization of the antenna is set on test. Each of the four sides of the EUT must be faced this transmitting antenna and measured individually. In order to judge the EUT performance, a CCD camera is used to monitor it. All the scanning conditions are as following:

Condition of Test	Remark
1. Fielded Strength	10V/m (Severity Level 3)
2. Radiated Signal	Modulated
3. Scanning Frequency	80-1000MHz
4. Sweep time of radiated	0.0015 Decade/s
5. Dwell Time	1 Sec.

9.7. Test Results

PASS.

Please refer to the following page.

RF Field Strength Susceptibility Test Results

EMTEK (SHENZHEN) CO., LTD..

Applicant : INVT POWER SYSTEM (SHENZHEN) CO., LTD.				
EUT : Uninterruptible Power Systems		Test Date : March 10, 2011		
M/N : RM090/15X		Temperature : 22°C		
Field Strength : 10 V/m		Humidity : 50 %		
Power Supply : AC 380V / 50Hz		Criterion : A		
Test Mode : AC mode/ Battery mode		Frequency Range: 80 MHz to 1000 MHz		
Modulation: <input type="checkbox"/> None <input type="checkbox"/> Pulse <input checked="" type="checkbox"/> AM 1KHz 80%				
		Frequency Rang 1: 80~ 1000MHz		Frequency Rang 2: N/A
Steps	1%			
	Horizontal	Vertical	Horizontal	Vertical
Front	PASS	PASS		
Right	PASS	PASS		
Rear	PASS	PASS		
Left	PASS	PASS		
<p>Test Equipment:</p> <ol style="list-style-type: none"> 1. Signal Generator: 2023B (AEROFLEX) 2. Power Amplifier: AS0102-55 (MILMEGA)&AP32MT215 (PRANA) 3. Log.-Per.Antenna: VULP9118E(SCHWARZBECK) 4. Broad-Band Horn Antenna: BBHA 9120L3F(SCHWARZBECK) 5. RF Power Meter. Dual Channel: 4232A(BOONTON) 6. Field Strength Meter: HI-6005 (HOLADAY) 				
Note:				

10. ELECTRICAL FAST TRANSIENT/BURST IMMUNITY TEST

10.1. Block Diagram of Test Setup

10.1.1. Block Diagram of the EUT.



(EUT: Uninterruptible Power Systems)

10.1.2. EFT Test Setup

AC Port:

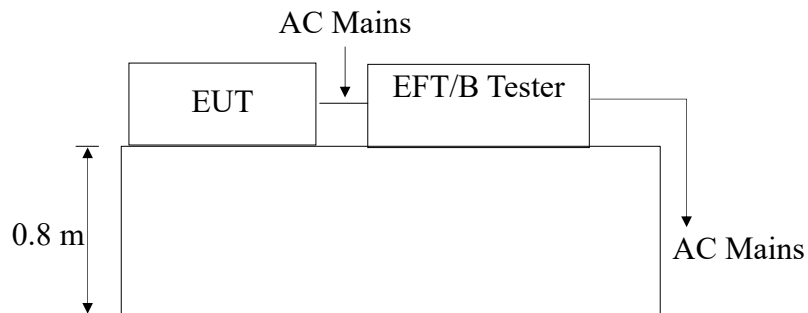

(EUT: Uninterruptible Power Systems)

10.2. Test Standard

EN62040-2:2006 (EN61000-4-4: 2012, Severity Level: 3, 2KV)

10.3. Severity Levels and Performance Criterion

10.3.1. Severity level

Open Circuit Output Test Voltage $\pm 10\%$		
Level	On Power Supply Lines	On I/O (Input/Output) Signal data and control lines
1	0.5 KV	0.25 KV
2	1 KV	0.5 KV
3	2 KV	1 KV
4	4 KV	2 KV
X	Special	Special

10.3.2. Performance criterion: B

10.4.EUT Configuration

The configuration of EUT is listed in Section 4.3.

10.5.Operating Condition of EUT

10.5.1.Setup the EUT as shown in Section 10.1.

10.5.2.Turn on the power of all equipments.

10.5.3.Let the EUT work in test mode (AC mode) and measure it.

10.6.Test Procedure

The EUT is put on the table that is 0.8 meter high above the ground. This reference ground plane shall project beyond the EUT by at least 0.1m on all sides and the minimum distance between EUT and all other conductive structure, except the ground plane beneath the EUT, shall be more than 0.5m.

10.6.1.For input and output AC power ports:

The EUT is connected to the power mains by using a coupling device that couples the EFT interference signal to AC power lines. Both polarities of the test voltage should be applied during compliance test and the duration of the test is 2 mins.

10.6.2.For signal lines and control lines ports:

It's unnecessary to test.

10.6.3.For DC output line ports:

It's unnecessary to test.

10.7.Test Result

PASS.

Please refer to the following page.

Electrical Fast Transient/Burst Test Results

EMTEK (SHENZHEN) CO., LTD.

Standard : <input checked="" type="checkbox"/> EN 61000-4-4	Result: <input checked="" type="checkbox"/> PASS / <input type="checkbox"/> FAIL		
Applicant : <u>INVT POWER SYSTEM (SHENZHEN) CO., LTD.</u>			
EUT : <u>Uninterruptible Power Systems</u>			
M/N : <u>RM090/15X</u>			
Input Voltage: <u>AC 380V / 50Hz</u>			
Criterion : B			
Ambient Condition : <u>22 °C</u> <u>50% RH</u>			
Operation Mode: AC mode			
Line : <input checked="" type="checkbox"/> AC Mains	Line : <input type="checkbox"/> Signal <input type="checkbox"/> I/O Cable		
Coupling : <input checked="" type="checkbox"/> Direct	Coupling : <input type="checkbox"/> Capacitive		
Test Time : 120s			
Line	Test Voltage	Result(+)	Result(-)
L1, L2, L3, N	2kV	PASS	PASS
L1-L2, L1-L3, L2-L3	2kV	PASS	PASS
L1-N, L2-N, L3-N,	2kV	PASS	PASS
L1-L2- N, L1-L3- N, L2-L3- N, L1-L2-L3	2kV	PASS	PASS
L1-L2-L3-N	2kV	PASS	PASS
Signal Line			
DC Line			
Note:			
Test Equipment		Burst Tester Model : PEFT 4010	

11.SURGE IMMUNITY TEST

11.1.Block Diagram of Test Setup

11.1.1.Block Diagram of the EUT.



(EUT: Uninterruptible Power Systems)

11.1.2.Surge Test Setup

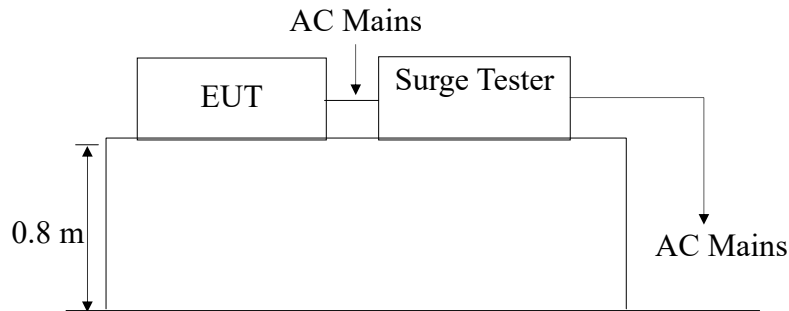

11.2.Test Standard

EN62040-2:2006
(EN61000-4-5: 2006, Line to Line: Severity Level 2, 1.0KV;)

11.3.Severity Levels and Performance Criterion

11.3.1.Severity level

Severity Level	Open-Circuit Test Voltage KV
1	0.5
2	1.0
3	2.0
4	4.0
*	Special

11.3.2.Performance criterion: A

11.4.EUT Configuration

The configuration of EUT is listed in Section 4.3.

11.5. Operating Condition of EUT

11.5.1. Setup the EUT as shown in Section 11.1.

11.5.2. Turn on the power of all equipments.

11.5.3. Let the EUT work in test mode (AC mode) and measure it.

11.6. Test Procedure

- 1) Set up the EUT and test generator as shown on Section 11.1.2.
- 2) For line to line coupling mode, provide 1.0 KV (1.2/50us) voltage surge,
For line to earth coupling mode, provide 2.0 KV (1.2/50us) voltage surge (At open-circuit condition). At least 5 positive and 5 negative (polarity) tests with a maximum 1/min repetition rate are conducted during test.
- 3) Different phase angles are done individually.
- 4) Record the EUT operating situation during compliance test and decide the EUT immunity criterion for above each test.

11.7. Test Result

PASS.

Please refer to the following page.

Surge Immunity Test Result

EMTEK (SHENZHEN) CO., LTD.

Applicant : <u>INVT POWER SYSTEM (SHENZHEN) CO., LTD.</u>		Test Date : <u>March 10, 2011</u>			
EUT : <u>Uninterruptible Power Systems</u>		Temperature : 22°C			
M/N : <u>RM090/15X</u>		Humidity : 50%			
Power Supply : <u>AC 380V / 50Hz</u>		Criterion : B			
Test Mode : <u>AC mode</u>					
Location	Polarity	Phase Angle	Number of Pulse	Pulse Voltage (kV)	Result
L1-L2, L1-L3, L2-L3	+	0°, 90°, 180°, 270°	5	1.0	PASS
	-	0°, 90°, 180°, 270°	5	1.0	PASS
L1-N, L2-N, L3-N	+	0°, 90°, 180°, 270°	5	1.0	PASS
	-	0°, 90°, 180°, 270°	5	1.0	PASS
				Test Equipment:PIM100, PCD130 Surge Tester: King	

12. INJECTED CURRENTS SUSCEPTIBILITY TEST

12.1. Block Diagram of Test Setup

12.1.1. Block Diagram of the EUT.

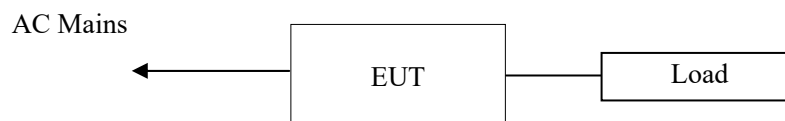

(EUT: Uninterruptible Power Systems)

12.1.2. Block Diagram of Test Setup

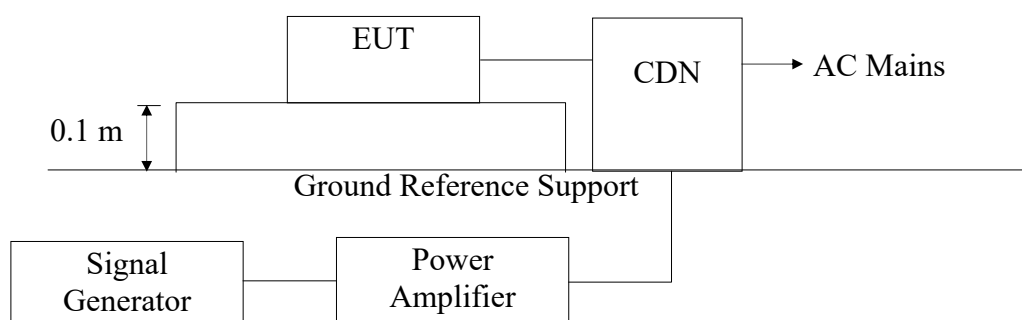

(EUT: Uninterruptible Power Systems)

12.2. Test Standard

EN62040-2:2006

(EN61000-4-6: 2009, Severity Level: Level 3, 10V (r.m.s.), 0.15MHz ~ 80MHz)

12.3. Severity Levels and Performance Criterion

12.3.1. Severity level

Level	Field Strength V
1	1
2	3
3	10
X	Special

12.3.2. Performance criterion: A

12.4. EUT Configuration

The configuration of EUT is listed in Section 4.3.

12.5. Operating Condition of EUT

12.5.1. Setup the EUT as shown in Section 12.1.

12.5.2. Turn on the power of all equipments.

12.5.3. Let the EUT work in test mode (AC mode) and measure it.

12.6. Test Procedure

- 1) Set up the EUT, CDN and test generators as shown on Section 12.1.2.
- 2) Let the EUT work in test mode and measure it.
- 3) For AC Mains: The EUT are placed on an insulating support 0.1m high above a ground reference plane. CDN (coupling and decoupling device) is placed on the ground plane about 0.3m from EUT. Cables between CDN and EUT are as short as possible, and their height above the ground reference plane shall be between 30 and 50 mm (where possible). The disturbance signal described below is injected to EUT through CDN. The EUT operates within its operational mode(s) under intended climatic conditions after power on.
- 4) The frequency range is swept from 150KHz to 80MHz using 10V signal level, and with the disturbance signal 80% amplitude modulated with a 1KHz sine wave.
- 5) The rate of sweep shall not exceed 1.5×10^{-3} decades/s. where the frequency is swept incrementally; the step size shall not exceed 1% of the start and thereafter 1% of the preceding frequency value.
- 6) Recording the EUT operating situation during compliance testing and decide the EUT immunity criterion.

12.7. Test Results

PASS.

Please refer to the following page.

Injected Currents Susceptibility Test Results

EMTEK (SHENZHEN) CO., LTD.

Applicant : <u>INVT POWER SYSTEM (SHENZHEN) CO., LTD.</u>				
EUT : <u>Uninterruptible Power Systems</u>		Test Date: <u>March 10, 2011</u>		
M/N : <u>RM090/15X</u>		Temperature : <u>22°C</u>		
Power Supply : <u>AC 380V / 50Hz</u>		Humidity : <u>58%</u>		
Test Engineer : <u>LB</u>				
Test Mode: <u>AC mode</u>				
Frequency Range (MHz)	Injected Position	Strength (Unmodulated)	Criterion	Result
0.15 ~ 80	AC Mains	10V	A	PASS
Test Mode : <u>N/A</u>				
Frequency Range (MHz)	Injected Position	Strength (Unmodulated)	Criterion	Result
Remark : 1. Modulation Signal:1KHz 80% AM Measurement Equipment : Simulator: CWS 500 (SWITZERLAND EMTEST) CDN : <input type="checkbox"/> CDN-M2 (SWITZERLAND EMTEST) <input checked="" type="checkbox"/> CDN-M4 (SWITZERLAND EMTEST)		Note:		

13. MAGNETIC FIELD SUSCEPTIBILITY TEST

13.1. Block Diagram of Test

13.1.1. Block diagram of test setup.



(EUT: Uninterruptible Power Systems)

13.1.2. Magnetic field test setup

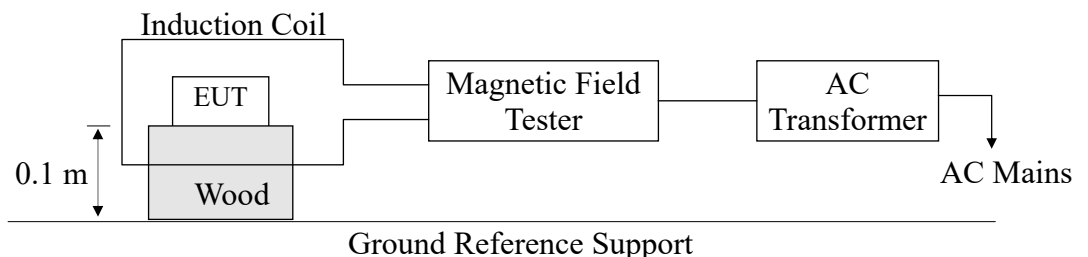

(EUT: Uninterruptible Power Systems)

13.2. Test Standard

EN62040-2:2006

(EN61000-4-8: 2010, Severity Level: Level 4, 30A / m)

13.3. Severity Levels and Performance Criterion

13.3.1. Severity Levels

Level	Field Strength A/m
1	1
2	3
3	10
4	30
5	100
X	Special

13.3.2. Performance Criterion: A

13.4.EUT Configuration on Test

The configuration of the EUT is same as Section 4.3.

13.5.Test Procedure

The EUT is placed in the middle of a induction coil (1*1m), under which is a 1*1*0.1m (high) table, this small table is also placed on a larger table, 0.8 m above the ground. Both horizontal and vertical polarization of the induction coil is set on test, so that each side of the EUT is affected by the magnetic field. Also can reach the same aim by change the position of the EUT.

13.6.Test Results

PASS.

Please refer to the following page.

Magnetic Field Immunity Test Result

EMTEK (SHENZHEN) CO., LTD.

Standard: <input checked="" type="checkbox"/> EN 61000-4-8	Result: <input checked="" type="checkbox"/> PASS / <input type="checkbox"/> FAIL			
Applicant : <u>INVT POWER SYSTEM (SHENZHEN) CO., LTD.</u> EUT : <u>Uninterruptible Power Systems</u> M/N : <u>RM090/15X</u> Input Voltage : <u>AC380V/50Hz</u> Date of Test : <u>March 10, 2011</u> Test Engineer: <u>LB</u> Ambient Condition : Temp : <u>22°C</u> Humid: <u>50%</u> Criterion: A				
Operation Mode: AC mode				
Test Level (A/M)	Testing Duration	Coil Orientation	Criterion	Result
30	5 mins	X	A	PASS
30	5 mins	Y	A	PASS
30	5 mins	Z	A	PASS
Operation Mode: N/A				
Test Level (A/M)	Testing Duration	Coil Orientation	Criterion	Result
Test Equipment	Magnetic Field Test: HEAFELY MAG 100.1			
Note:				

14. VOLTAGE DIPS AND INTERRUPTIONS TEST

14.1. Block Diagram of Test Setup

14.1.1. Block Diagram of the EUT.



(EUT: Uninterruptible Power Systems)

14.1.2. Dips Test Setup

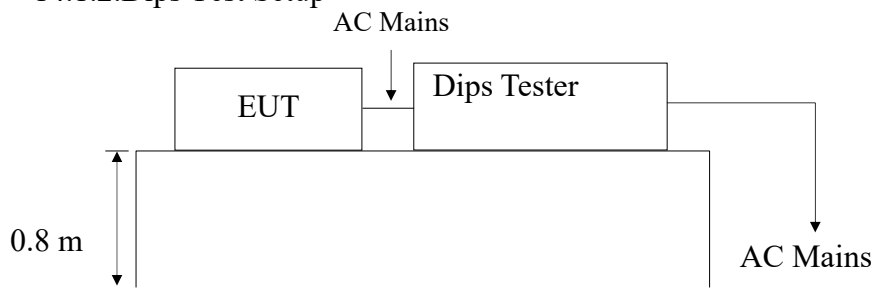

(EUT: Uninterruptible Power Systems)

14.2. Test Standard

EN62040-2:2006 (EN61000-4-11: 2004, Class 3)

14.3. Severity Levels and Performance Criterion

14.3.1. Severity level

Test Level %UT	Voltage dip and short interruptions %UT	Duration (in period)
0	100	0.5
0	100	1
40	60	12
70	30	30
80	20	300

14.3.2. Performance criterion: B&C

14.4.EUT Configuration

The configuration of EUT is listed in Section 4.3.

14.5.Operating Condition of EUT

14.5.1.Setup the EUT as shown in Section 14.1.

14.5.2.Turn on the power of all equipments.

14.5.3.Let the EUT work in test mode (AC mode) and measure it.

14.6.Test Procedure

- 1) Set up the EUT and test generator as shown on Section 14.1.2.
- 2) The interruption is introduced at selected phase angles with specified duration.
- 3) Record any degradation of performance.

14.7.Test Result

PASS.

Please refer to the following page.

Voltage Dips and Interruptions Test Results

EMTEK (SHENZHEN) CO., LTD.

Applicant : <u>INVT POWER SYSTEM (SHENZHEN) CO., LTD.</u>				
EUT : <u>Uninterruptible Power Systems</u>			Test Date : <u>March 10, 2011</u>	
M/N : <u>RM090/15X</u>			Temperature : <u>22°C</u>	
Power Supply : <u>AC 380V / 50Hz</u>			Humidity : <u>50%</u>	
Test Mode: <u>AC mode</u>				
Test Level % U _T	Voltage Dips & Short Interruptions % U _T	Duration (in periods)	Criterion <input checked="" type="checkbox"/> A <input type="checkbox"/> B <input type="checkbox"/> C <input type="checkbox"/> D	Result P=PASS F=FAIL
0	100	0.5p	A	P
0	100	1 p	A	P
40	60	12 p	A	P
70	30	30 p	A	P
80	20	300 p	A	P
Test Mode : <u>N/A</u>				
Test Level % U _T	Voltage Dips & Short Interruptions % U _T	Duration (in periods)	Criterion <input type="checkbox"/> A <input type="checkbox"/> B <input type="checkbox"/> C <input type="checkbox"/> D	Result P=PASS F=FAIL
Note:				

15. LOW FREQUENCY SIGNALS TEST

15.1. Block Diagram of Test Setup

15.1.1. Block Diagram of the EUT

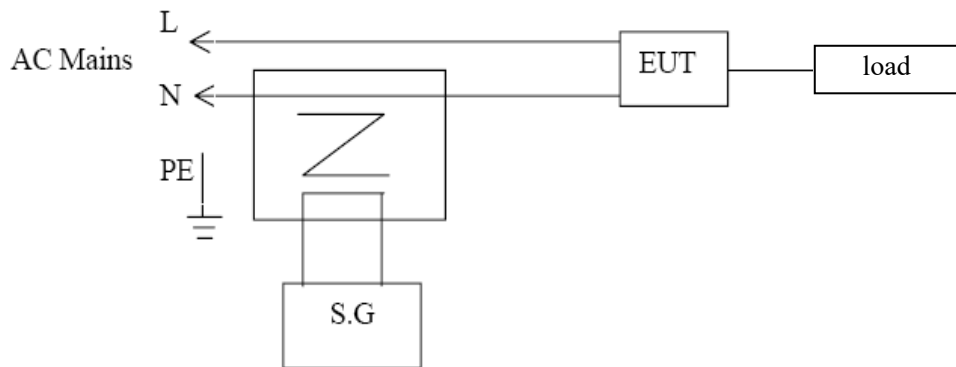

(EUT: Uninterruptible Power Systems)

15.1.2. Block Diagram of Test Setup

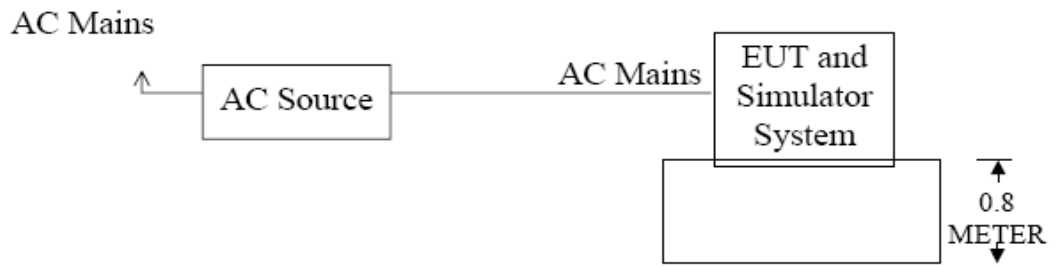

(EUT: Uninterruptible Power Systems)

15.2. Test Standard

EN61000-2-2: 2002, Performance: A

15.3. Operating Condition of EUT

Same as Section 4.5, Except the test setup replaced by Section 15.1.

15.4. Test Results

PASS.

Please refer to following pages.

Low Frequency Signals Test Result

EMTEK (SHENZHEN) CO., LTD.

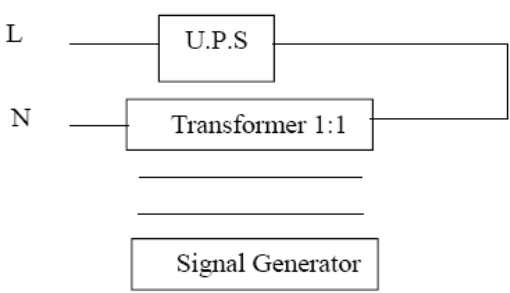
Applicant : <u>INVT POWER SYSTEM (SHENZHEN) CO., LTD.</u> EUT : <u>Uninterruptible Power Systems</u> M/N : <u>RM090/15X</u> Power Supply : <u>AC380V/50Hz</u> Test Engineer : <u>LB</u>			Test Date: <u>March 10, 2011</u> Temperature : <u>22°C</u> Humidity : <u>58%</u> Test Mode : <u>AC mode</u>	
Frequency Range (Hz)	Position	Strength	Result	Note
140	See Fig.1	10V(rms) Sinusoidal	PASS	
160			PASS	
200			PASS	
240			PASS	
280			PASS	
320			PASS	
360			PASS	
Note 			Test Equipment: 1. Isolation transformer Primary: Secondary=1:1 2. Signal Generator AC Source: 65930(Chroma)	

16.PHOTOGRAPH

16.1.Photo of Conducted Emission Measurement



16.2.Photo of Radiation Emission Measurement

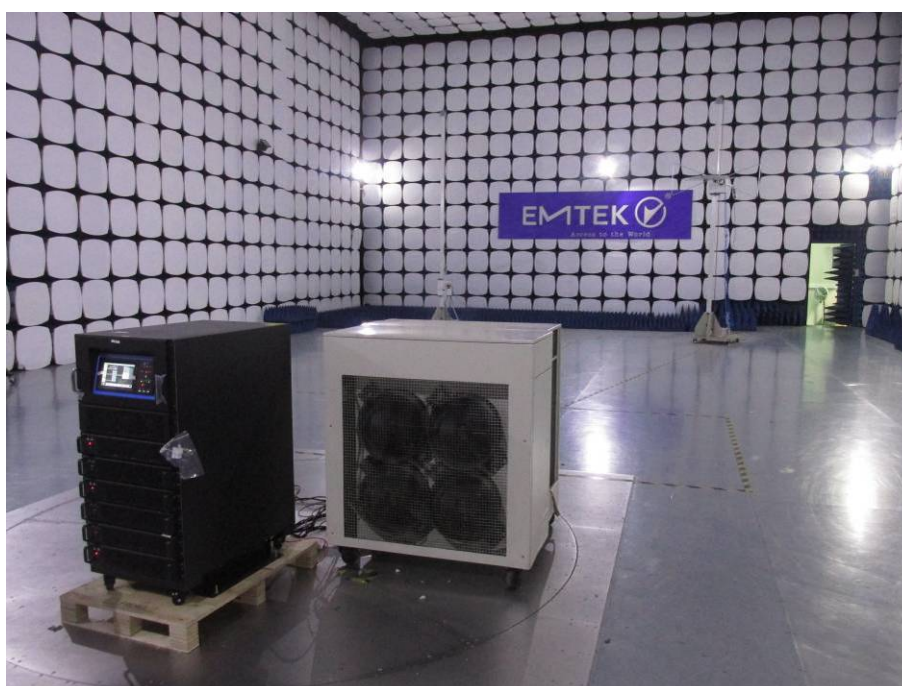

16.3. Photo of Electrostatic Discharge Test



16.4. Photo of Electrical Fast Transient / Burst Test



16.5.Photo of Injected Currents Susceptibility Test



16.6.Photo of Magnetic Field Immunity Test



16.7.Photo of Voltage Dips and Interruption Immunity Test



16.8.Photo of low Frequency Signals Test



16.9.Photo of RF Field Strength Susceptibility Test

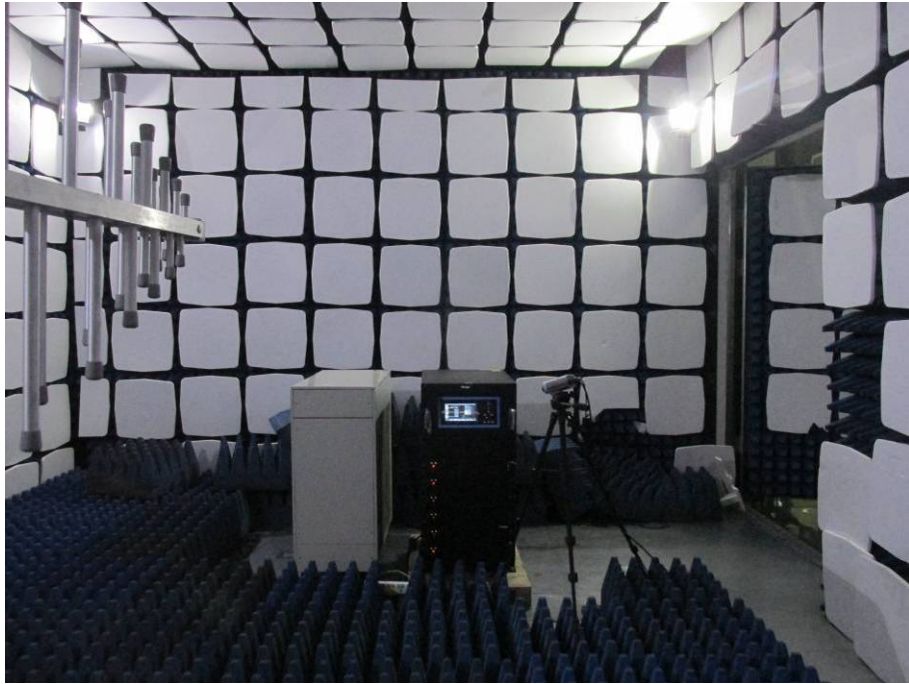

16.10.Photo of Surge Test



APPENDIX I

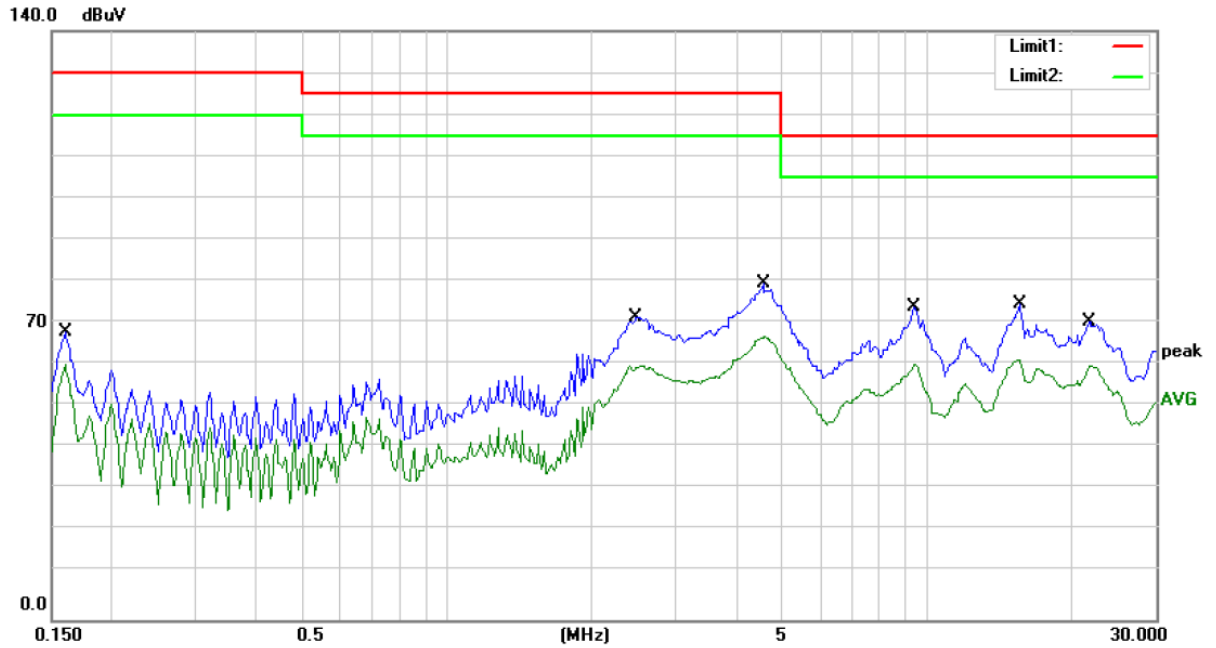

Site Conduction #2

Phase: **N**

Temperature: 26

Limit: (CE)EN62040-2 C3_QP(>100A)

Power: AC 380V/50Hz

Humidity: 55 %

EUT: Uninterruptible Power Systems

M/N: RM090/15X

Mode: AC MODE

Note:

No.	Mk.	Freq.	Reading Level	Correct Factor	Measurement	Limit	Over	Detector	Comment
		MHz	dBuV	dB	dBuV	dBuV	dB		
1		0.1600	68.27	0.00	68.27	130.00	-61.73	QP	
2		0.1600	60.72	0.00	60.72	120.00	-59.28	AVG	
3		2.4800	71.92	0.00	71.92	125.00	-53.08	QP	
4		2.4800	60.41	0.00	60.41	115.00	-54.59	AVG	
5		4.5900	79.86	0.00	79.86	125.00	-45.14	QP	
6		4.5900	67.37	0.00	67.37	115.00	-47.63	AVG	
7		9.4000	74.48	0.00	74.48	115.00	-40.52	QP	
8		9.4000	60.83	0.00	60.83	105.00	-44.17	AVG	
9	*	15.6000	75.20	0.00	75.20	115.00	-39.80	QP	
10		15.6000	61.75	0.00	61.75	105.00	-43.25	AVG	
11		21.8000	70.99	0.00	70.99	115.00	-44.01	QP	
12		21.8000	60.54	0.00	60.54	105.00	-44.46	AVG	

*:Maximum data x:Over limit !:over margin Comment: Factor build in receiver. Operator: HJ

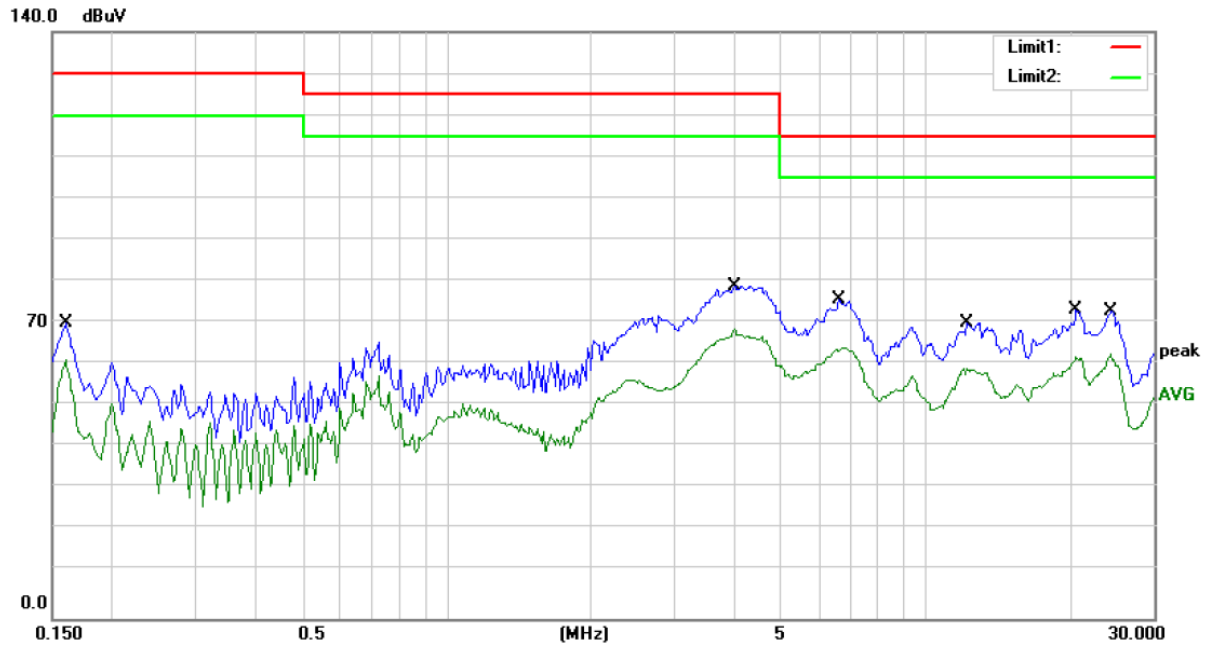

Site Conduction #2

Phase: **L1**

Temperature: 26

Limit: (CE)EN62040-2 C3_QP(>100A)

Power: AC 380V/50Hz

Humidity: 55 %

EUT: Uninterruptible Power Systems

M/N: RM090/15X

Mode: AC MODE

Note:

No.	Mk.	Freq.	Reading Level	Correct Factor	Measurement	Limit	Over	Detector	Comment
		MHz	dBuV	dB	dBuV	dBuV	dB		
1		0.1600	70.46	0.00	70.46	130.00	-59.54	QP	
2		0.1600	61.67	0.00	61.67	120.00	-58.33	AVG	
3		4.0000	79.34	0.00	79.34	125.00	-45.66	QP	
4		4.0000	69.07	0.00	69.07	115.00	-45.93	AVG	
5	*	6.6800	76.27	0.00	76.27	115.00	-38.73	QP	
6		6.6800	64.64	0.00	64.64	105.00	-40.36	AVG	
7		12.2000	70.69	0.00	70.69	115.00	-44.31	QP	
8		12.2000	59.62	0.00	59.62	105.00	-45.38	AVG	
9		20.6000	73.59	0.00	73.59	115.00	-41.41	QP	
10		20.6000	62.33	0.00	62.33	105.00	-42.67	AVG	
11		24.4750	73.49	0.00	73.49	115.00	-41.51	QP	
12		24.4750	63.08	0.00	63.08	105.00	-41.92	AVG	

*:Maximum data x:Over limit !:over margin Comment: Factor build in receiver. Operator: HJ

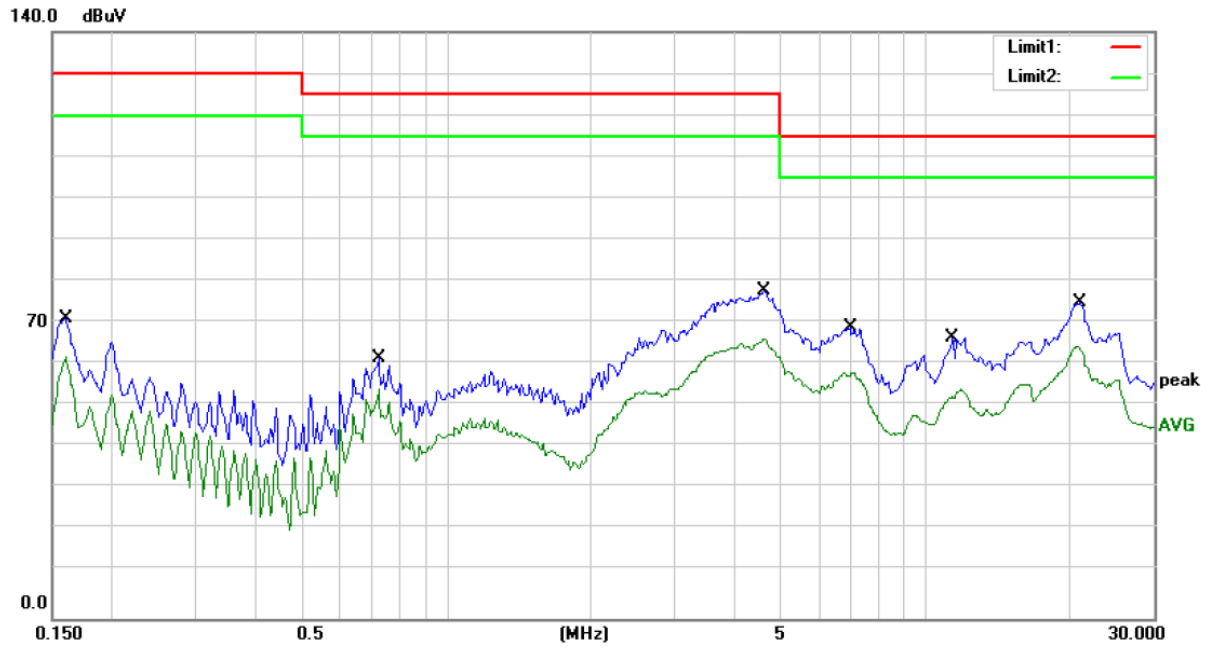

Site Conduction #2

Phase: **L2**

Temperature: 26

Limit: (CE)EN62040-2 C3_QP(>100A)

Power: AC 380V/50Hz

Humidity: 55 %

EUT: Uninterruptible Power Systems

M/N: RM090/15X

Mode: AC MODE

Note:

No.	Mk.	Freq.	Reading Level	Correct Factor	Measurement	Limit	Over	Detector	Comment
		MHz	dBuV	dB	dBuV	dBuV	dB		
1		0.1600	71.71	0.00	71.71	130.00	-58.29	QP	
2		0.1600	62.34	0.00	62.34	120.00	-57.66	AVG	
3		0.7200	62.06	0.00	62.06	125.00	-62.94	QP	
4		0.7200	54.89	0.00	54.89	115.00	-60.11	AVG	
5		4.6000	78.06	0.00	78.06	125.00	-46.94	QP	
6		4.6000	66.75	0.00	66.75	115.00	-48.25	AVG	
7		7.0000	69.39	0.00	69.39	115.00	-45.61	QP	
8		7.0000	58.48	0.00	58.48	105.00	-46.52	AVG	
9		11.4000	67.03	0.00	67.03	115.00	-47.97	QP	
10		11.4000	54.83	0.00	54.83	105.00	-50.17	AVG	
11	*	21.0000	75.26	0.00	75.26	115.00	-39.74	QP	
12		21.0000	64.86	0.00	64.86	105.00	-40.14	AVG	

*:Maximum data x:Over limit !:over margin Comment: Factor build in receiver. Operator: HJ

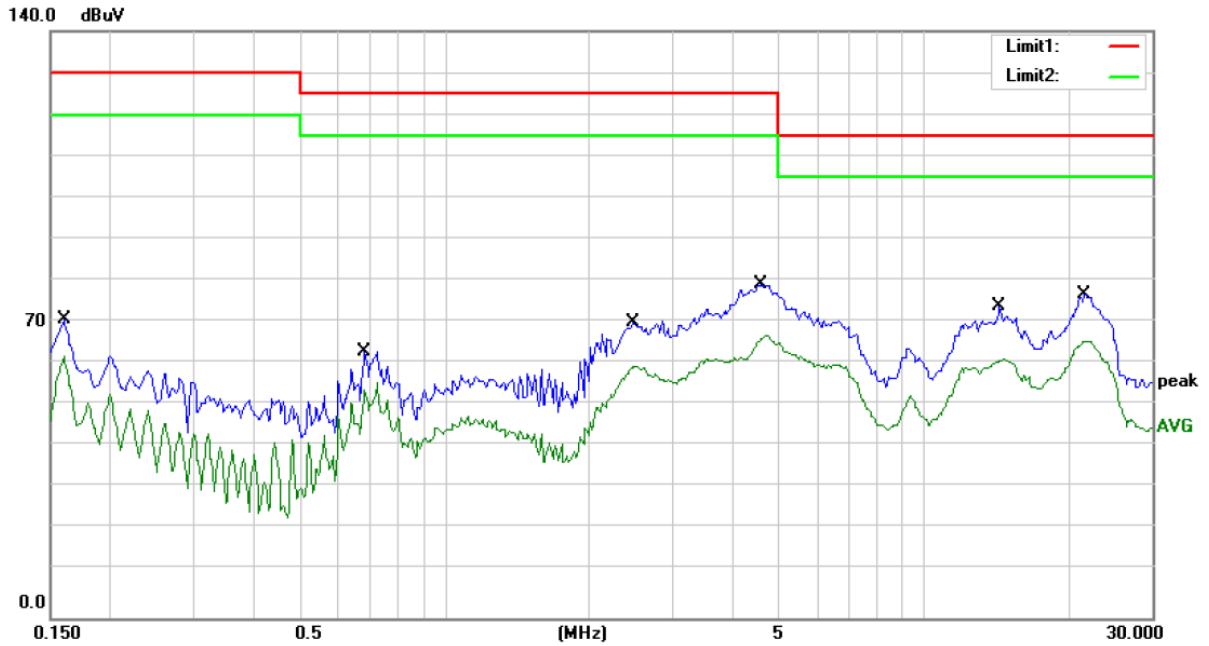

Site Conduction #2

Phase: **L3**

Temperature: 26

Limit: (CE)EN62040-2 C3_QP(>100A)

Power: AC 380V/50Hz

Humidity: 55 %

EUT: Uninterruptible Power Systems

M/N: RM090/15X

Mode: AC MODE

Note:

No.	Mk.	Freq.	Reading Level	Correct Factor	Measure-ment	Limit	Over	Detector	Comment
		MHz	dBuV	dB	dBuV	dBuV	dB		
1		0.1600	71.09	0.00	71.09	130.00	-58.91	QP	
2		0.1600	62.34	0.00	62.34	120.00	-57.66	AVG	
3		0.6800	63.67	0.00	63.67	125.00	-61.33	QP	
4		0.6800	56.15	0.00	56.15	115.00	-58.85	AVG	
5		2.4750	70.61	0.00	70.61	125.00	-54.39	QP	
6		2.4750	60.04	0.00	60.04	115.00	-54.96	AVG	
7		4.5900	79.47	0.00	79.47	125.00	-45.53	QP	
8		4.5900	67.43	0.00	67.43	115.00	-47.57	AVG	
9		14.4000	74.48	0.00	74.48	115.00	-40.52	QP	
10		14.4000	61.71	0.00	61.71	105.00	-43.29	AVG	
11	*	21.5250	77.20	0.00	77.20	115.00	-37.80	QP	
12		21.5250	66.10	0.00	66.10	105.00	-38.90	AVG	

*:Maximum data x:Over limit !:over margin Comment: Factor build in receiver. Operator: HJ

APPENDIX II

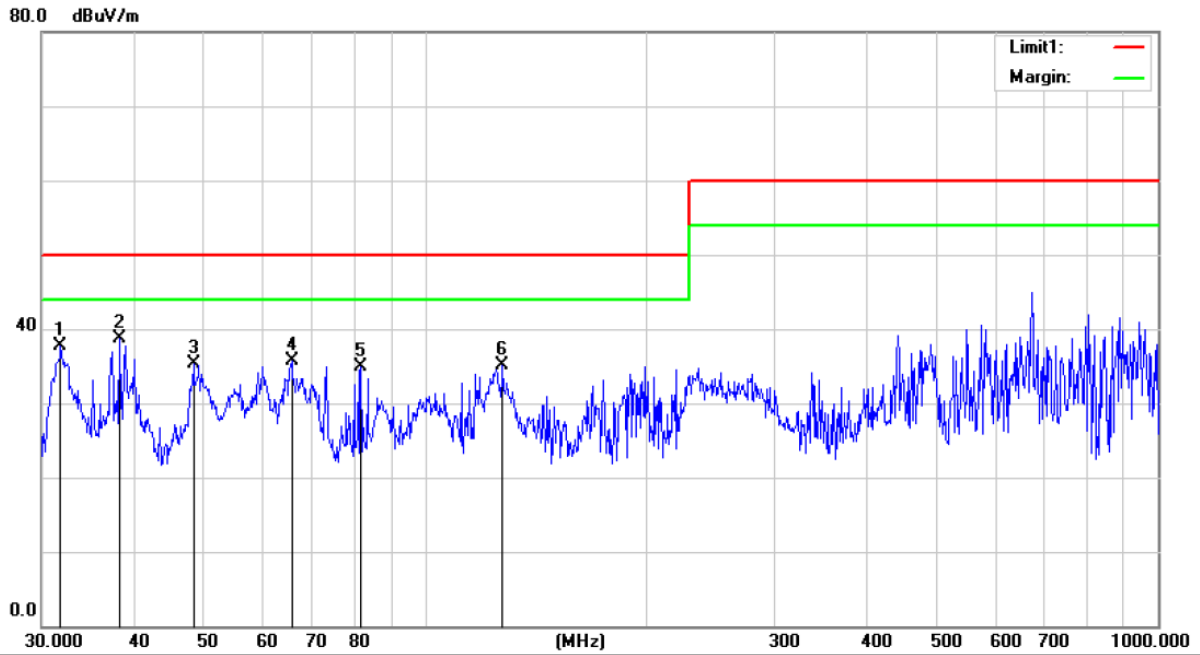

Site :10m Chamber #1 Polarization: **Horizontal** Temperature: 26
 Limit: (RE 10M)EN62040-2 C3 Power: AC 380V/50Hz Humidity: 60 %
 EUT: UNINTERRUPTIBLE POWER SYSTEMS
 M/N: RM090/15X
 Mode:FULL LOAD
 Note: LINE MODE

No.	Mk.	Freq.	Reading Level	Correct Factor	Measurement	Limit	Over	Antenna Height	Table Degree		
		MHz	dBuV	dB	dBuV/m	dBuV/m	dB	Detector	cm	degree	Comment
1		31.8427	68.78	-31.16	37.62	50.00	-12.38	QP	308	359	
2	*	38.3462	68.85	-30.11	38.74	50.00	-11.26	QP	308	359	
3		48.3318	64.28	-28.99	35.29	50.00	-14.71	QP	308	359	
4		65.8031	68.25	-32.47	35.78	50.00	-14.22	QP	308	359	
5		81.7833	69.33	-34.37	34.96	50.00	-15.04	QP	308	359	
6		127.6645	68.79	-33.62	35.17	50.00	-14.83	QP	308	359	

*:Maximum data x:Over limit !:over margin

Operator: CSL

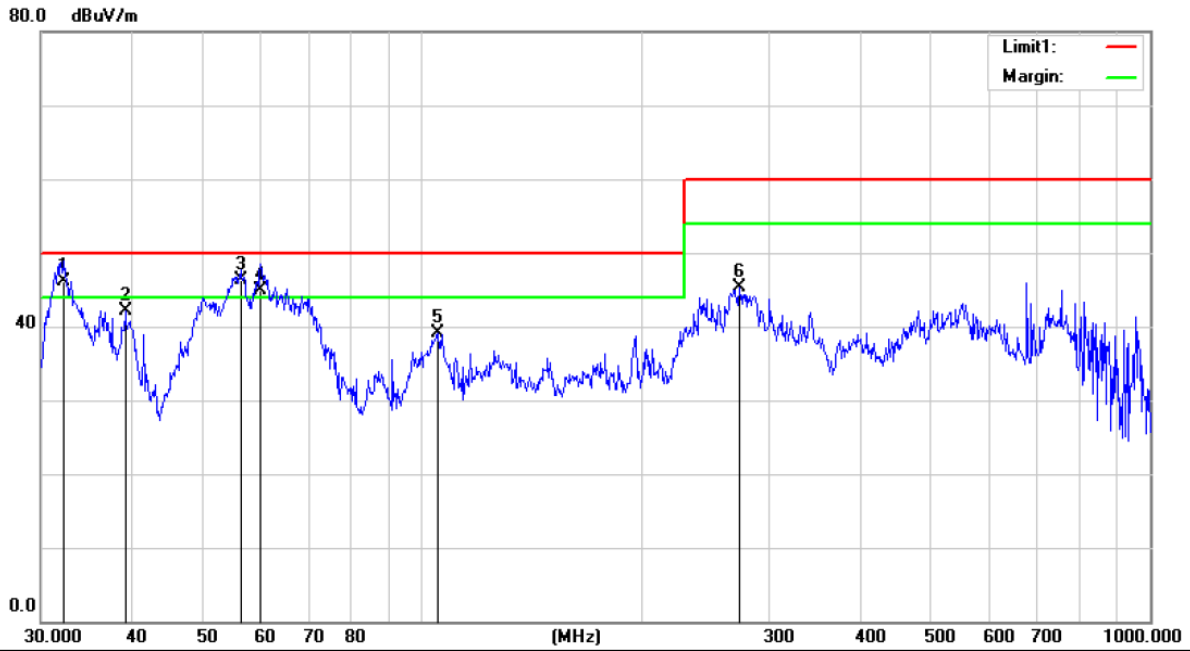

Site :10m Chamber #1 Polarization: **Vertical** Temperature: 26
 Limit: (RE 10M)EN62040-2 C3 Power: AC 380V/50Hz Humidity: 60 %
 EUT: UNINTERRUPTIBLE POWER SYSTEMS
 M/N: RM090/15X
 Mode:FULL LOAD
 Note: LINE MODE

No.	Mk.	Freq.	Reading Level	Correct Factor	Measurement	Limit	Over	Antenna Height	Table Degree	
		MHz	dBuV	dB	dBuV/m	dBuV/m	dB	cm	degree	Comment
1	!	32.2924	77.49	-31.29	46.20	50.00	-3.80	199	359	
2		39.1615	72.09	-29.96	42.13	50.00	-7.87	199	133	
3	*	56.3947	75.66	-29.36	46.30	50.00	-3.70	199	359	
4	!	60.0690	74.60	-29.70	44.90	50.00	-5.10	199	359	
5		105.2717	69.23	-30.21	39.02	50.00	-10.98	199	359	
6		273.2341	72.37	-26.98	45.39	60.00	-14.61	199	359	

*:Maximum data x:Over limit !:over margin

Operator: CSL

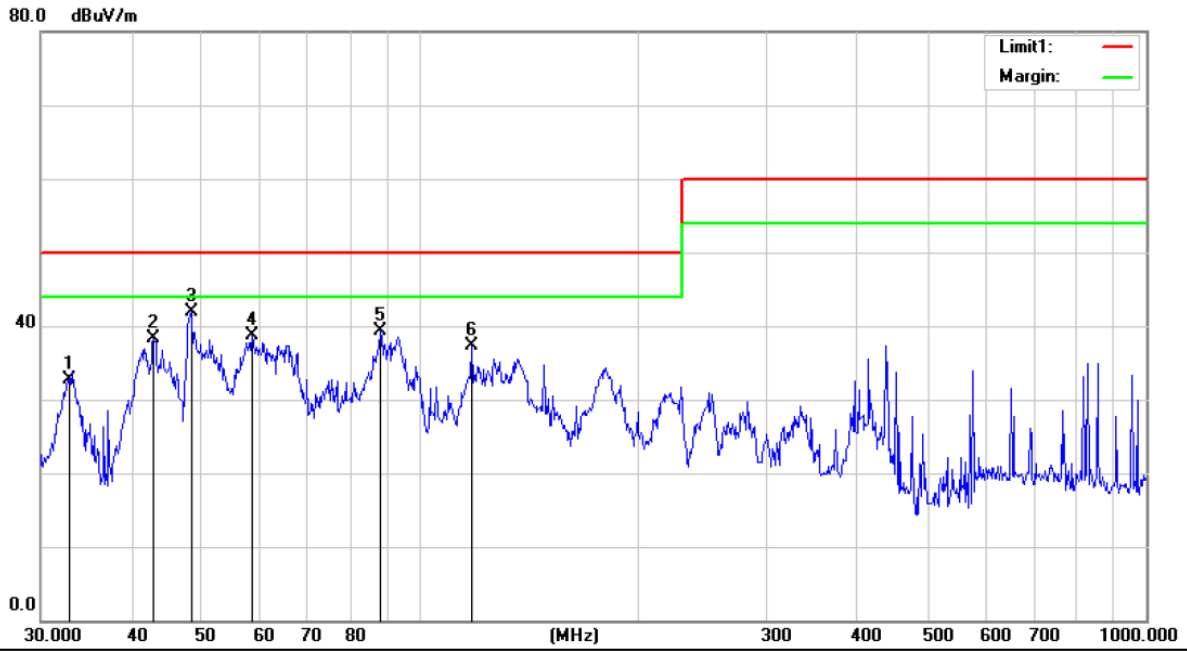

Site :10m Chamber #1

Polarization: **Horizontal**

Temperature: 26

Limit: (RE 10M)EN62040-2 C3

Power: AC 380V/50Hz

Humidity: 60 %

EUT: UNINTERRUPTIBLE POWER SYSTEMS

M/N: RM090/15X

Mode:FULL LOAD

Note: BAT MODE

No.	Mk.	Freq.	Reading Level	Correct Factor	Measurement	Limit	Over	Antenna Height	Table Degree	
		MHz	dBuV	dB	dBuV/m	dBuV/m	dB	cm	degree	Comment
1		32.8637	65.96	-33.16	32.80	50.00	-17.20	QP		
2		42.8997	69.05	-30.84	38.21	50.00	-11.79	QP		
3	*	48.3318	72.22	-30.41	41.81	50.00	-8.19	QP		
4		58.6126	70.33	-31.72	38.61	50.00	-11.39	QP		
5		88.0327	73.69	-34.47	39.22	50.00	-10.78	QP		
6		117.7724	70.98	-33.69	37.29	50.00	-12.71	QP		

*:Maximum data x:Over limit !:over margin

Operator: CSL

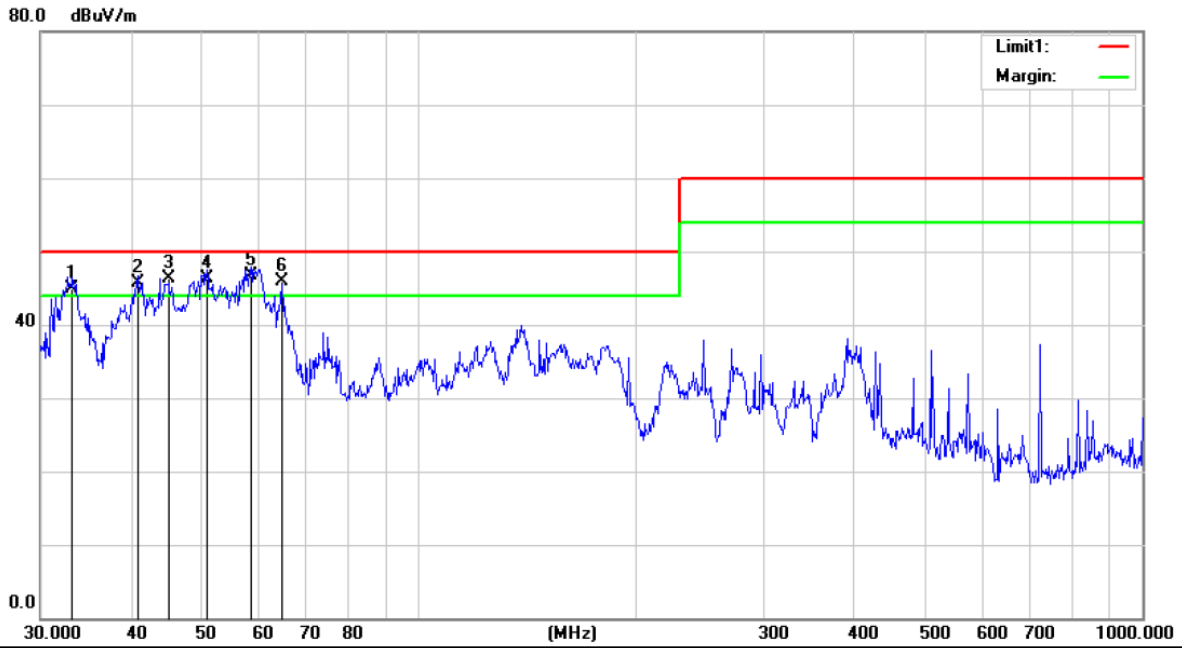

Site :10m Chamber #1

Polarization: **Vertical**

Temperature: 26

Limit: (RE 10M)EN62040-2 C3

Power: AC 380V/50Hz

Humidity: 60 %

EUT: UNINTERRUPTIBLE POWER SYSTEMS

M/N: RM090/15X

Mode:FULL LOAD

Note: BAT MODE

No.	Mk.	Freq.	Reading Level	Correct Factor	Measurement	Limit	Over	Antenna Height	Table Degree	
		MHz	dBuV	dB	dBuV/m	dBuV/m	dB	cm	degree	Comment
1	!	33.2111	77.63	-32.73	44.90	50.00	-5.10	QP		
2	!	40.8444	76.59	-30.79	45.80	50.00	-4.20	QP		
3	!	45.0583	76.19	-29.98	46.21	50.00	-3.79	QP		
4	!	50.9420	76.16	-29.86	46.30	50.00	-3.70	QP		
5	*	58.6126	76.27	-29.47	46.80	50.00	-3.20	QP		
6	!	64.6594	77.40	-31.49	45.91	50.00	-4.09	QP		

*:Maximum data x:Over limit !:over margin

Operator: CSL

APPENDIX III (Photos of EUT)







