Maintenance manual

For 11 serial 6-10K



Front panel



Rear panel

Version 1.0

In March 2016

Important Safety Instructions

This manual contains important safety instructions. Read all safety and operating instructions before operating the uninterruptible power systems (UPS). Adhere to all warnings on the unit and in this manual. Follow all operating and user instructions. This equipment can be operated by individuals without previous training.

This product designed for commercial/industrial use only. It is intended for use with lift support and other designated “critical” devices. Maximum load must not exceed that shown on the UPS rating label. The UPS is designed for data processing equipment. If uncertain, consult your dealer or local representative.



WARNING OF BATTERY

The battery can present a risk of electrical shock and high short circuit current. Following precautions should be observed before replace the battery or maintain standard ups.

- I Wear rubber gloves and boots.
- I Remove rings, watches and other metal objects.
- I Use tools with insulated handles.
- I Do not lay tools or other metal objects on the batteries.
- I If the battery is damaged in any way or shows signs of leakage, contact your local representative immediately.
- I Do not dispose of batteries in a fire. The batteries may explode.
- I Handle, transport and recycle batteries in accordance with local representative.



WARNING

Although ups has been designed and manufactured to ensure personal safety, improper use also can result in electrical shock or fire. To ensure safety, observe the following precautions:

- I Turn off and unplug the UPS before cleaning it.
- I Clean the UPS with a dry cloth. Do not use liquid or aerosol cleaners.
- I Never block or insert any objects into the ventilation holes or other openings of the UPS.
- I Do not place the UPS power cord where it might be damaged.
- I If fire, please use the dry powder fire extinguishers. If use liquid extinguisher, there may has get an electric shock risk.
- I Before turn on ups, please check that whether the cable and the polarity of the batteries are correct.

Important Tips:

When need to replace board, please turn off ups, disconnect the mains switch and battery switch (built-in battery, please unplug at least one battery cable), wait for 10 minutes.

CONTENTS

1 System Description	1
1.1 Overall System Diagram.....	1
2 Panel instruction and operation.....	1
2.1 Panel instruction	1
2.2 Commonly used panel operation.....	4
2.2.1 Turn on UPS in normal mode	4
2.2.2 Turn on UPS in battery mode.....	4
2.2.3 Turn off UPS in normal mode.....	4
2.2.4 Turn off UPS in battery mode	4
2.3 Operation Mode Instruction	5
2.3.1 Normal mode	5
2.3.2 Battery mode.....	5
2.3.3 Parallel mode	5
3 Hardware Detection	5
3.1 Input filter Board Detection.....	6
3.2 SCR Board Detection.....	6
3.3 Rectifier Board Detection	7
3.4 Inverter Board Detection.....	8
4 Common fault location and ruled out	9
4.1 Bypass voltage abnormal and frequency out of Track.....	9
4.2 Utility abnormal	9
4.3 Rectifier Fault	9
4.4 Inverter Protection	10
4.5 Charge fault when turn on UPS	10
4.6 Output short circuit	10
5 S-code	11

1 System Description

1.1 Overall System Diagram

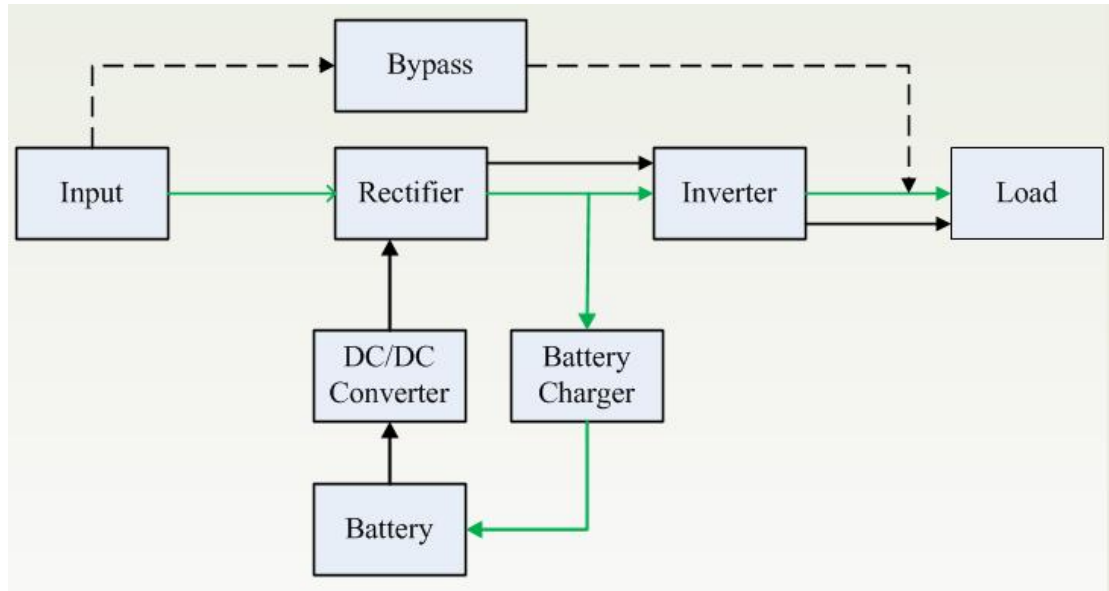

Fig.1.1 System Diagram

Normal mode (The green line): Through rectifier, utility transform AC to DC. Inverter utilize the DC output, then transform DC to precise、 regulated sine wave AC power. Meanwhile DC Bus voltage charge battery, the standard UPS with 1A charger, long backup time UPS with 5A charger.

Battery mode (The black line): Through DC/DC converter, battery discharge power to DC BUS, then inverter transform DC to precise、 regulated sine wave AC power.

Bypass mode (The black dotted line): Utility directly feed the load, when utility abnormal, the output will have brief interruptible.

2 Panel instruction and operation

Operation of LCD panel is very important for maintenance personnel to quickly master the UPS; this step will greatly improve the efficiency of UPS maintenance.

2.1 Panel instruction

Fig2.1 is 11 serial front panels, and the panel is easy to operate UPS.

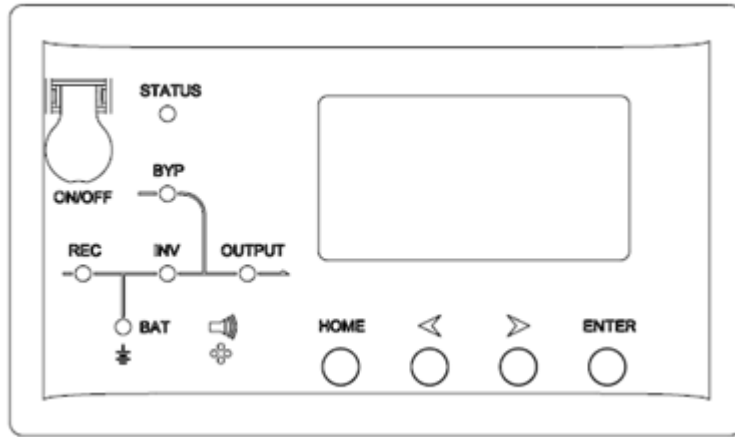

Fig 2.1 Front Panel

Panel instruction:

Controls	Description
ON/OFF	1. Press on/off to start inverter when rectifier is OK NOTE: Not available when inverter is set in automatically start mode 2. Press on/off directly when there is no main input, press again for 3 seconds to start UPS 3. Press on/off for 3 seconds to shutdown inverter when UPS is in normal mode. 4. Press on/off for 3 seconds to shutdown UPS completely when UPS is in battery mode
HOME	Back to main menu
◀ ▶	Left and right
ENTER	Press to choose
Indicators	Description
STATUS	UPS status: green--normal mode, red--UPS is abnormal
REC	Rectifier indicator: green--rectifier is normal, green flicker--rectifier is starting, red--rectifier fault, red flicker--rectifier alarm, dark—rectifier is not working
INV	Inverter indicator: green--inverter is normal, green flicker--inverter is starting or tracking with bypass(ECO), red—inverter fault and load is not on inverter, red flicker—inverter fault and load is on inverter, dark—inverter is not working
BYP	Bypass indicator: green—bypass is normal, dark—UPS is in normal mode and bypass is normal, red—bypass fault, red flicker—bypass alarm
BAT	Battery indicator: green—battery charge, green flicker—battery discharge, dark—battery is connected, red—battery fault, red flicker—battery alarm
OUTPUT	Output indicator: green—output is normal, red—output alarm

Fig 2.2 is LCD main menu; provide lots of information about UPS.

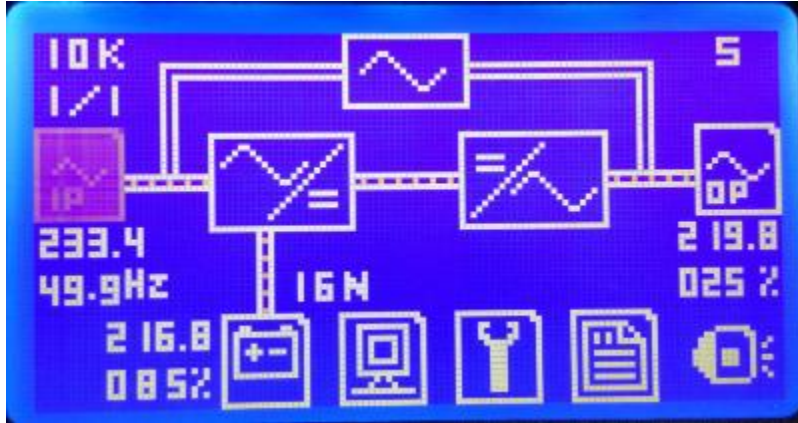









Fig 2.2LCD Main Menu

LCD main menu instruction

Display	Function	Submenu
	Input information	Main input: voltage, current, frequency, PF
	Battery information	Battery: voltage, discharge current, battery status, battery temperature, capacity
	Output information	Output information:
	Status of UPS	Alarms, S-code, soft version, system information
	Set and function	Set: language, contrast, communication set(SNT, Modbus), Modbus set
	History log	
10K 1/1	System parameter	Rated capacity: 10KVA 1 phase in, 1 phase out
233.4	Input voltage	
216.8 85%	Battery voltage and capacity remained	
219.8 025%	Output voltage and load percent	
P2	System working mode	S--single mode, E--ECO mode, P-parallel mode, 2-the unit ID is 2 in system, the units ID in parallel system should be different
	Mute on, mute off	

2.2 Commonly used panel operation

2.2.1 Turn on UPS in normal mode

1)、 After confirm the connected cable, close the battery switch (only applicable to external battery models), then close the input switch, UPS will begin to start, fans rotate.

2)、 After rectifier indicator(REC) steady green, press the "ON/OFF" key for 3 seconds, select "ON" start inverter, inverter indicator(INV) turn green flicker.

NOTE: Not available when inverter is set in automatically start mode.

3)、 Wait for about 1 minute, UPS run in normal mode. At this point if the utility is abnormal, UPS will run in battery mode.

2.2.2 Turn on UPS in battery mode

1)、 After confirm the connected cable, close the battery switch (only applicable to external battery models).

2)、 Click the "ON/OFF" key, power board start work, fans rotate.

3)、 Press the "ON/OFF" key for 3 seconds, select "ON", battery indicator turn green flicker, then INV indicator turn green flicker. Wait for about 1 minute, UPS run in battery mode.

2.2.3 Turn off UPS in normal mode

1)、 Press the "ON/OFF" key for 3 seconds, select "OFF" to turn off inverter, UPS run in bypass mode.

2)、 If it is long backup time model, disconnect the utility and battery switch, UPS is completely off.

If it is standard model, disconnect the utility switch, press the "ON/OFF" key for 3 seconds, and select "OFF" to turn off UPS.

2.2.4 Turn off UPS in battery mode

1)、 Press the "ON/OFF" key for 3 seconds, select "OFF", wait for seconds, UPS is completely off.

2)、 For long backup time model, please disconnect battery switch after turn off UPS.

EE Note: Please turn off the connected loads before turning on the UPS, turn on the loads one by one after the UPS is working in normal mode. Turn off all of the connected loads before turning off the UPS.

2.3 Operation Mode Instruction

2.3.1 Normal mode

UPS work in normal mode, rectifier indicator(REC)、inverter indicator(INV)、battery indicator(BAT)、output indicator(Output) and status indicator(STATUS) are green, bypass indicator(BYP) is off. UPS inverter feed load, battery in charge.

2.3.2 Battery mode

When utility is abnormal, UPS work in battery mode. When battery voltage is close to EOD voltage, fault alarm will appear. If utility still don't come, UPS will automatic off.

EE Note: UPS internal still has a high voltage, please do not touch terminals.

2.3.3 Parallel mode

1)、Normal mode

Parallel UPS work in normal mode, UPS inverter provides power supply sharing.

2)、Battery mode

When utility abnormal, parallel UPS all work in battery mode, UPS inverter provides power supply sharing.

3)、Bypass mode

Utility directly feed the load, when utility abnormal, the output will have brief interruptible.

4)、Fault mode

When one UPS in parallel system is fault, the fault UPS will turn off inverter. Meanwhile, if another UPS have enough capacity, it will separately feed the load, if another UPS do not have enough capacity, the double UPS will transform to bypass mode.

EE Note: 31/11 series UPS do not support sharing a set of batteries; each UPS must use a group of independent batteries.

3 Hardware Detection

Because power board and internal structure of HR11 (6-10KVA) are similar, now with HR1110L (more power boards) for example shows how to use multimeter to measure main components.

First, we need to measure fuse、rectifier SCR、battery discharge SCR、PFC-IGBT and inverter IGBT.

Below picture is the ups overall figure, each functional part have been marked. Standard model only have 1 piece of charger. 6-10K do not have single SCR board SCR is welded in rectifier board.

Parallel board is option component; single ups do not take the board.

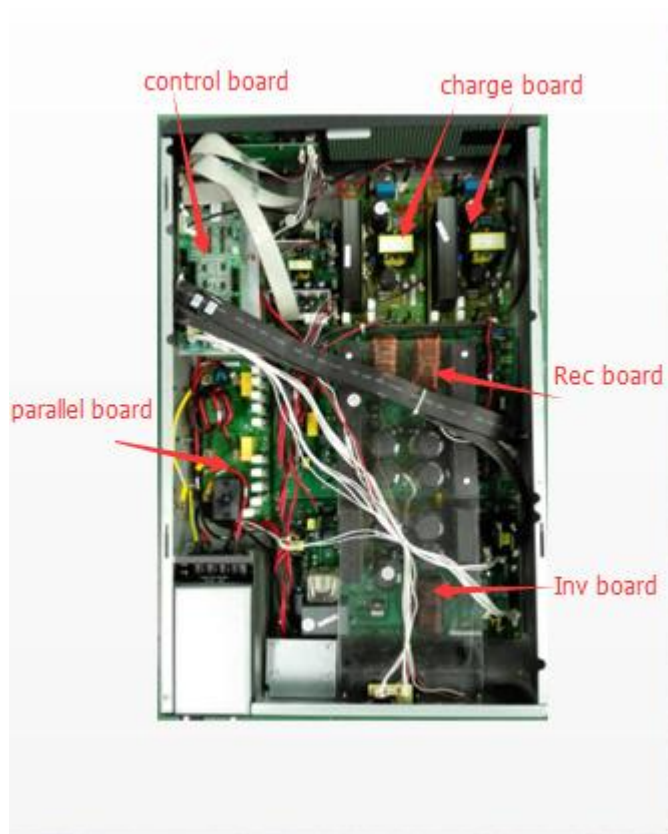

Fig 2.3 overall figures

3.1 Input filter Board Detection

For this board, we just need measure fuse. If main input fuse is broken, probably because rectifier SCR or PFC-IGBT is broken, so please pay more attention when measuring other power board.

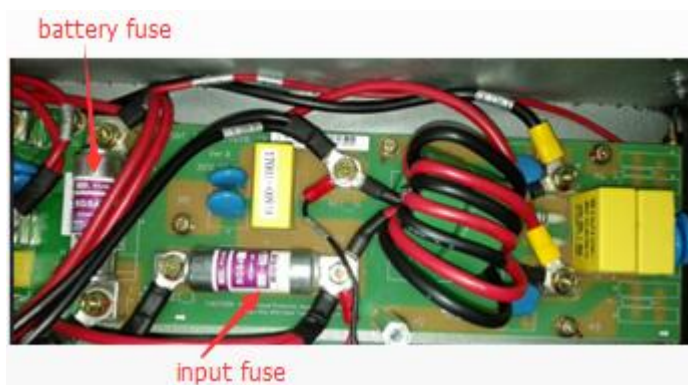

Fig 2.5 input filter board

3.2 SCR Board Detection

6-10KVA series UPS, SCR all are the same type. Multimeter use resistance gear, the red pen pick 1 foot, black pen for 3 foot, resistance between 20Ω ~ 70Ω is

normal . Red pen pick 2 foots, black pen for 1 foot, no short ci rcui t is normal , usual ly K Ω or M Ω . Now take an example, other SCR measure method is same.



Fig 2.6SCR detection

3.3 Rectifier Board Detection

6-10KVA series UPS, PFC-IGBT all are the same type. Mul timeter use diode gear, the red pen pick 3foots, black pen for 2 foot, vol tage round 0.4V is normal . Multimeter use resistance gear, the red pen pick 1 foot, black pen for 3 foot, resistance 25K Ω or 17K Ω or so.

Next measure the fly-wheel diode D1, D2, red and black pens pick 1,2 foot, vol tage around 0.4 Vi s normal . If vol tage is not stabl e, pl ease exchange red and black pens, try agai n.

Now take an example, other PFC-IGBT and diode measure method are same.



3.4 Inverter Board Detection

6-10KVA series UPS, inverter IGBT all are the same type. Measure method is the same as PFC-IGBT. Multimeter use diode gear, the red pen pick 3 foots, black pen for 2 foot, voltage around 0.4V is normal. Multimeter use resistance gear, the red pen picks 1 foot, black pen for 3 foot, and resistance around 25K Ω or 17K Ω .

4 Common fault location and ruled out

When UPS appear failure, we first need to quickly locate fault point. When UPS can start, we need to observe indicator state in the process of start.

After the rectifier is OK, UPS start inverter. If inverter failure appears from the start, inverter power board maybe faults. If inverter failure appears at the period of start, load may have fault.

For most case, we first clear fault, restart UPS to exclude and analyze failure.

4.1 Bypass voltage abnormal and frequency out of Track

If ups only appear this 2 alarm, it does not UPS using. Common reasons for the phenomenon:

1. The poor quality of utility, the utility voltage fluctuation is huge;
2. UPS absorb energy from generator;

Solution:

1. For 1 and 2, Connect monitor software modified bypass voltage alarm limiting, frequency tracking speed.

Note: Old UPS version does not support this change, please consult engineers.

4.2 Utility abnormal

Common reasons for the phenomenon:

1. Utility cable connect error;
2. Utility input switch open;
3. Input fuse broken.

Solution:

1. Check the input cable;
2. Close the utility switch;
3. Close the utility switch, observe input voltage from LCD panel, if abnormal, please contact agency.

Disconnect utility, turn on UPS in battery mode, if UPS can work normal, the power board probable do not have fault.

4.3 Rectifier Fault

Common reasons for the phenomenon:

1. Control board false signal;
2. Rectifier SCR fault;
3. PFC-IGBT in Rectifier board fault.

Solution:

-
1. Restart UPS after fault clear;
Check whether the signal cable connect suitable;
 2. For 2 and 3,
 - a) Turn on UPS in normal mode, please immediately check the bus voltage, if bus voltage not up, after turn off UPS, please use multimeter to measure the rectifier SCR, if abnormal, please contact agency.
 - b) Turn on UPS in battery mode, please immediately check the bus voltage, if bus voltage not up, after turn off UPS, please use multimeter to measure IGBT, if abnormal, please contact agency.

4.4 Inverter Protection

Common reasons for the phenomenon:

1. Whether UPS feed motor type load;
2. Control board fault signal interference;
3. Inverter IGBT fault;

Solution:

1. Please disconnect load, restart UPS to check it;
2. Restart UPS after fault clear;
3. Turn off UPS, measure the inverter IGBT, if abnormal, please contact agency.

4.5 Charge fault when turn on UPS

Common reasons for the phenomenon:

1. Battery discharge deeply;
2. Charge board fault.

Solution:

1. Close utility and battery switch, click "ON/OFF" to light up LCD panel, Maintain this state 10 ~ 30 minutes to charge the battery;
2. Please contact agency.

4.6 Output short circuit

Common reasons for the phenomenon:

1. Control board fault signal locked;
2. Output cables connect error.

Solution:

1. Restart UPS after fault clear;
2. Check the output cable.

5 S-code

When appear fault, press  to get S-code. S0、S1 mean work status, A0-A5 mean exact fault about UPS, S-code list is shown as follow:

SEQ		Items	0	1	Solution	
1	A0	1 Synchronous Fault	Sync	Not sync.	Check whether bypass voltage/frequency is normal	
2		2 Main Input Fault	OK	Fault	Check whether input is normal	
3		3 REC Fault	OK	Fault	REC over temperature, bus overvoltage, input current unbalance, soft start fail	
4		4 INV Fault	OK	Fault	INV over temperature, INV IGBT broken, INV relay fault	
5		5 Reserved				
6		6 Reserved				
7		7 Reserved				
8		8 Reserved				
9		9 Reserved				
10		10 Reserved				
11		11 Reserved				
12		12 Reserved				
13		13	Input phase A over current	OK	Fault	Check if rectifier IGBT is broken, DC bus is shorted, or IGBT drivers are lost, input voltage display is wrong
14	14	Input phase B over current	OK	Fault		
15	15	Input phase Cover current	OK	Fault		
16	16	Output voltage Fault	OK	Fault	Check if inverter IGBT is broken, IGBT drivers are lost	
17	A1	1 Reserved				
18		2 Reserved				
19		3 Reserved				
20		4 Reserved				
21		5 Reserved				
22		6 Reserved				
23		7 Reserved				
24		8 Reserved				
25		9	Input voltage Fault	OK	Fault	Input voltage out of range
26		10	Input Frequency Fault	OK	Fault	Input frequency out of range
27		11	Input Sequence Fault	OK	Fault	Input sequence is wrong, check whether input wires connection is ok.
28		12	REC soft-start Fault	OK	Fault	Check whether rectifier SCR is broken, or SCR drivers are lost.
29		13	Reserved			
30		14	Reserved			

31		15	REC over temperature	OK	Fault	Check if the environmental temperature is over 40, if rectifier IGBTs is properly installed.
32		16	Positive bus over voltage	OK	Fault	UPS requires service
33	A2	1	Negative bus over voltage	OK	Fault	UPS requires service
34		2	Fan Fault	OK	Fault	At least one of fans fail.
35		3	Reserved			
36		4	Reserved			
37		5	Positive bus under voltage	OK	Fault	UPS requires service
38		6	Negative bus under voltage	OK	Fault	UPS requires service
39		7	Battery reversed	OK	Fault	Check if the battery wires connection is OK
40		8	Reserved			
41		9	Reserved			
42		10	Reserved			
43		11	Reserved			
44		12	Reserved			
45		13	Battery over temperature	OK	Fault	Check if environmental temp is too high or batteries life is over
46		14	Reserved			
47		15	Reserved			
48		16	Reserved			
49	A3	1	Battery voltage low	OK	Fault	
50		2	Reserved			
51		3	Battery EOD	OK	Fault	
52		4	Reserved			
53		5	Reserved			
54		6	Reserved			
55		7	BYP voltage Fault	OK	Fault	Check if bypass input voltage is normal
56		8	Bypass SCR or relay fault	OK	Fault	UPS requires service.
57		9	Reserved			
58		10	Reserved			
59		11	BYP frequency over track range	OK	Fault	Check if bypass input frequency is abnormal
60		12	Reserved			
61		13	Reserved			
62		14	Over load time out	OK	Fault	
63		15	Reserved			
64		16	Reserved			
65	A4	1	Manual shutdown	normal	shut down	
66		2	INV protect	OK	Fault	
67		3	Transfer times limit in one hour	OK	Fault	Transfer times between inverter and bypass is over 5 times in one hour
68		4	Reserved			

69		5	Reserved			
70		6	Reserved			
71		7	Reserved			
72		8	INV over temperature Fault	OK	Fault	Check if environmental temp is over 40°C, or fans are abnormal
73		9	Reserved			
74		10	Reserved			
75		11	Over load	OK	Over load	Check load level indicator and remove non-essential load. Recalculate the load and remove number of loads connected to UPS.
76		12	INV relay or fuse Fault	OK	Fault	Check if inverter relay is shorted or opened.
77		13	Reserved			
78		14	Parallel connection fault	OK	Fault	Check whether parallel connection cable disconnect.
79		15	Reserved			
80		16	Reserved			
81		1	Reserved			
82		2	Output shorted	OK	Fault	Shutdown UPS and open output breaker, check if load is effective or short internally, check if output connector is shorted.
83		3	Battery test	None	OK	2--Fault
84		4	Battery maintenance	None	OK	2--Fault
85		5	Reserved			
86		6	Reserved			
87		7	Reserved			
88	A5	8	Reserved			
89		9	Reserved			
90		10	Reserved			
91		11	Reserved			
92		12	Reserved			
93		13	Reserved			
94		14	Reserved			
95		15	Reserved			
96		16	Reserved			