

Mobile DVR Installation Instruction Guide

March, 2013

Table of Contents

| | | |
|----------|---|----------|
| 1 | PREPARATION | 1 |
| 1.1 | General Installation Process | 1 |
| 1.2 | Installation Plan..... | 1 |
| 1.3 | Installation Tools..... | 1 |
| 1.4 | Installation Material | 1 |
| 1.4.1 | Cable..... | 1 |
| 1.4.2 | Screw..... | 1 |
| 1.4.3 | BS Thread Rod and Screw Cap | 2 |
| 1.4.4 | Protection Coil, Electrical Conduit and Protection Groove | 2 |
| 1.5 | Preparation | 2 |
| 1.6 | Installation Principle | 2 |
| 1.6.1 | Mobile DVR Installation..... | 2 |
| 1.6.2 | Camera and Pickup Installation..... | 3 |
| 2 | DEVICE INSTALLATION | 5 |
| 2.1 | Device General Introduction | 5 |
| 2.1.1 | Front Panel | 5 |
| 2.1.2 | Rear Panel..... | 5 |
| 2.2 | Cable Connection Sample..... | 7 |
| 2.2.1 | Connecting Video Output..... | 9 |
| 2.3 | Connecting Audio Input & Output, Bidirectional Audio | 9 |
| 2.3.1 | Audio Input..... | 9 |
| 2.3.2 | Audio Output..... | 11 |

| | | |
|-------------|--|-----------|
| 2.4 | Installation Dimension..... | 12 |
| 2.5 | HDD Installation..... | 12 |
| 2.6 | Installation Position | 15 |
| 2.6.1 | Installation Position and Space..... | 15 |
| 2.6.2 | Technical Requirements | 16 |
| 2.7 | Camera Installation | 17 |
| 2.7.1 | Quantity | 17 |
| 2.7.2 | Installation Position..... | 17 |
| 2.7.3 | Installation Requirements | 17 |
| 2.7.4 | Installation Reference Image | 17 |
| 2.8 | The Alarm Button Chassis Installation | 18 |
| 2.8.1 | Installation Quantity | 18 |
| 2.8.2 | Installation Requirements | 18 |
| 2.9 | Cable Layout | 18 |
| 2.10 | Device Cable Connection..... | 18 |
| 2.10.1 | The Mobile and Camera Connection | 18 |
| 2.10.2 | Device Cable..... | 19 |
| 3 | SETUP AND DEBUG..... | 20 |
| 3.1 | Log in..... | 20 |
| 3.2 | Remote Control..... | 20 |
| 3.3 | Mouse..... | 22 |
| 3.4 | Live View..... | 23 |
| 3.5 | Menu Operation | 24 |

3.6 General Setup (Plate Setup)..... 24

3.7 Auto Maintenance..... 25

3.8 Encode 25

3.9 Search..... 27

3.10 FAQ 29

4 APPENDIX MOBILE DVR INSTALLATION ACCEPTANCE CERTIFICATE 30

1 Preparation

1.1 General Installation Process

Before installation, you need to know the installation includes the following steps:

- You need to select the installation plan and installation technique according to your vehicle type.
- You need to properly arrange the schedule for the vehicle to be installed.
- Write down the vehicle plate number and its corresponding device number.
- Select the installation position and complete the preparation works (dig holes, dismantle and etc.).
- Lay down the cable.
- DVR cable connection
- DVR installation
- Whole system debug and test.

1.2 Installation Plan

The installation engineer and the people from vehicle technical department shall work together to draw out the installation plan and techniques. The both sides shall select the installation vehicle together and the on-site engineer is responsible to get the device and accessory, check the quality and upgrade the mobile DVR software. During the installation process, the installation group is responsible to record the device corresponding code, technique check, cable connection and system debug.

1.3 Installation Tools

The mobile DVR installation tool list is shown as below:

- Phillips screwdriver
- Bent strippers
- Wire strippers
- Needle nose pliers
- Adjustable wrenches
- Electronic runner (Dry cell runner is preferred since on the site you need to connect to the 220V power, it is not convenient.)
- Multimeter
- LCD for debug
- A 2-meter steel cable (diameter 1.5mm.) to cable layout
- 3.2mm and 4.5mm aiguille

1.4 Installation Material

1.4.1 Cable

Cable is used to connect the power and the vehicle signal. For cable connected to the power, please use 1.0 square meter or higher 3-pin cable. For cable connect the vehicle signal, please use 0.25 square meter or higher 2-pin or 3-pin cable (including shielded layer).

1.4.2 Screw

Screw is used to fix the camera or pick-up. Usually we use M5×12/ M5×14 self tapping screw to fix the camera and M3×8/ M3×12 self tapping screw to fix the pickup. You can select according to you actual environment.

1.4.3 BS Thread Rod and Screw Cap

They are used to fix the device. Usually, we do not need these two accessories. If the installation position is difficult to choose, maybe you need them.

1.4.4 Protection Coil, Electrical Conduit and Protection Groove

The trunking protection is shown as in Figure 1-1.



Figure 1-1

The tube protection is shown as below. See Figure 1-2.



Figure 1-2

1.5 Preparation

- Before installation please arrange the installation device and accessories. At the same time, record the device test and code.
- The installation group includes: one carriage worker, one electrician, one locksmith, one technical instructor and one technical engineer from your local retailer.
- The construction side shall provide the necessary installation condition such as the external power.
- If necessary, you can complete necessary preparation work, such as put the cable into the bellows).

1.6 Installation Principle

Mobile monitor system installation includes: mobile DVR installation, camera installation, pickup installation, and cable layout and cable connection.

1.6.1 Mobile DVR Installation

Mobile DVR installation shall following the listed principles:

- Please fix the mobile DVR firmly.
- The mobile DVR shall be away from the great vibration. You can install it at the rear of the driver seat or the front part of the vehicle. Please note the installation location shall not disturb the driver operation.
- Please guarantee the sound ventilation and keep general distance from other devices. Do not install in the locked box such as the vehicle tool box.
- The external cable shall have sound distance and protection to guarantee cable electronic safety.
- Please make sure the mobile DVR is away from the heating objects.
- Please check the installation is even. Any unstable installation may result in device damage.
- When installing, please reserve considerable space for the HDD box to draw out.

1.6.2 Camera and Pickup Installation

The camera and pickup installation position is depending on the monitor area your client focus.

1.6.2.1 Camera Installation

Camera installation shall following the listed principles:

- The installation position shall allow the client to view the specified zone.
- Camera shall be easy to install and fix.
- Camera cable layout is convenient.
- There shall be no object to obstruct the camera.
- Please take the light direction factor into consideration.

1.6.2.2 Cable Layout

The cable layout is very important for mobile monitor system. The standard cable layout can guarantee system stability and reliability. Please note:

- All cable shall be in the protection cable. The cable installation shall go along with the original cable and binding with the previous one. Please make sure the cable layout is neat and hidden in case the driver or passenger may break it.
- Mobile DVR power cable: The mobile DVR shall connect to the storage battery of the vehicle and there shall be no control button. The cable is 3-pin power cable and its diameter shall be over than 1.0 square millimeters. (The cable connection shall be interlaid in case there is short circuit.). The cable length is depending on client requirement. Please note the battery position end and negative end shall be uniform. ACC signal cable shall connect to the vehicle key live cable. The video cable and audio cable shall adopt 4-pin flame retardation insulation protection cable and its diameter shall be over 0.5 square millimeters.
- GPS antenna: For the mobile DVR to get the signal from GPS satellite, please install the GPS signal receive antenna at the proper front position of the vehicle. Then dig a hole to connect the transmission cable to the vehicle. Please use the glass cement or other way to seal the cable so that there is sound airproof of the vehicle. Please note, you should handle carefully, otherwise it may result in antenna damage.
- During the cable layout, please make sure all cable are safe and will not be damaged. All connections and welding are safe and secure. The installation cable in the vehicle shall be properly tied and the two ends shall be neat and plain. The installation cable outside of the vehicle shall be fixed by the glass cement. The entire cable layout in the vehicle shall avoid the friction and the entire layout shall adopt the proper fasten way.
- The cable strap shall be tighten and even. When use protection cable, please make sure there is no displacement and the cable can bend easily.

- All cable can work properly. There is no short circuit or wrong connection. Cable shall not open to the air directly. Please fasten the cable each 50cm when system adopts invisible cable layout. Please use rubber insulating blanket when the cable strap goes through the metal or side panel.
- All the cable layout and device installation here shall conform to your local electronic safety code.

1.6.2.3 Cable Connection

Please connect the cable according to the signal symbol and the cable color.

Note: before connection, please make sure all the cable is OK and the signal is valid. After connection, please weld the connection point and use the heat-shrinkable tube to guarantee the intensity.

Important

- All working engineers shall prepare the necessary installation tool.
- All the connection shall be done by the professional engineer.
- Please make sure the mobile DVR and vehicle are sound earthed, otherwise it may result in property damage or property loss!

2 Device Installation

2.1 Device General Introduction

2.1.1 Front Panel

The front panel is shown as in Figure 2-1.

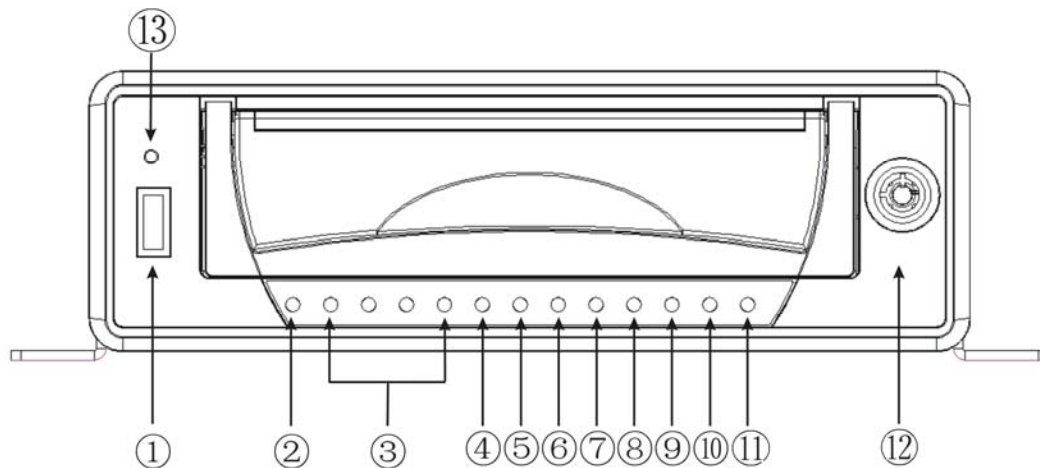

Figure 2-1

Please refer to the following sheet for front panel button information.

| SN | Function |
|----|--|
| 1 | USB2.0 port(Blue) |
| 2 | Power indication light.(Red) |
| 3 | Channel record status indication light. It is on in normal status. It becomes flashing when abnormal event occurred.(Blue) |
| 4 | Lock/unlock indication light (Blue) |
| 5 | Backup indication light (Blue) |
| 6 | SD card indication light (Blue) Please note only the unit of SD card module supports this function. |
| 7 | HDD indication light (Blue) |
| 8 | GPS indication light. (Blue) Please note only the unit of GPS module supports this function. |
| 9 | LAN indication light.(Blue) |
| 10 | 3G indication light. (Blue) Please note only the unit of 3G module supports this function. |
| 11 | WIFI indication light. (Blue) Please note only the unit of WIFI module supports this function. |
| 12 | HDD locker.(Blue) |

2.1.2 Rear Panel

The mobile DVR rear panel is shown as in Figure 2-2. **Please note slight difference may be found in the rear panel. Your DVR may not support all the functions listed below.**

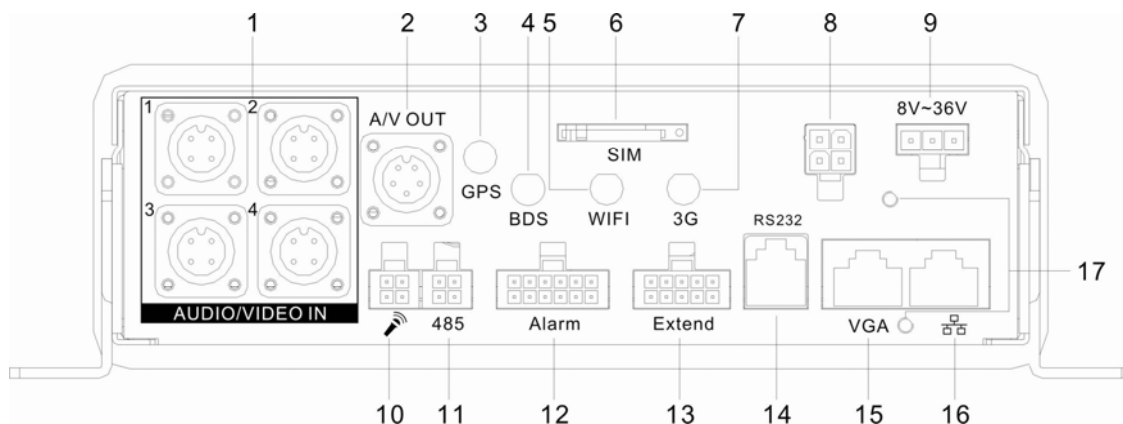

Figure 2-2

Please refer to the following sheet for detailed information.

| SN | Function |
|----|--|
| 1 | Audio/video input and camera power output port. |
| 2 | Audio/video output |
| 3 | GPS antenna port Please note only the unit of GPS module supports this function. |
| 4 | Compass navigation module antenna port Please note only the unit of special module supports this function. |
| 5 | WIFI antenna port Please note only the unit of WIFI module supports this function. |
| 6 | SIM card socket Please note only the unit of 3G module supports this function. |
| 7 | 3G antenna port Please note only the unit of 3G module supports this function. |
| 8 | 5V output and camera 12V input |
| 9 | Device power input |
| 10 | Bidirectional talk port |
| 11 | RS485 port |
| 12 | Alarm input /output port. |
| 13 | Extension port |
| 14 | RS232 port |
| 15 | VGA port |
| 16 | Buckle to secure RJ45 network port (See Figure 2-4) |

Extension port

The extension port is shown as below. See Figure 2-3.

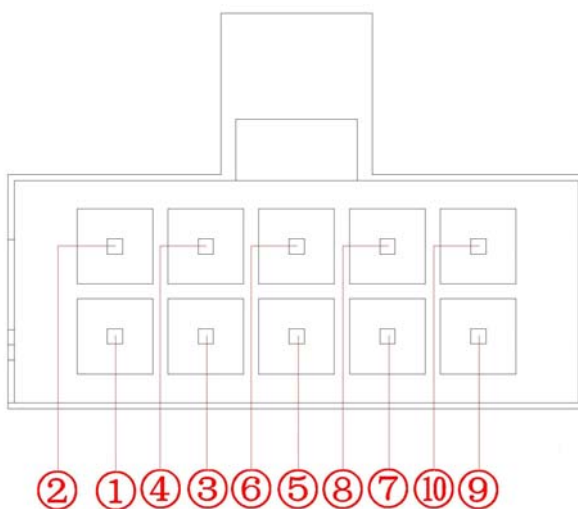

Figure 2-3

Please refer to the following sheet for detailed information.

| SN | Function |
|---------|-------------------------|
| 1 | 5V output |
| 2/4/6/8 | USB port |
| 3 | Remote control receiver |
| 5 | Light |
| 7 | Video output (+) |
| 8 | GND |
| 9 | RXD_232 |
| 10 | TXD_232 |

The buckle is shown as in Figure 2-4.

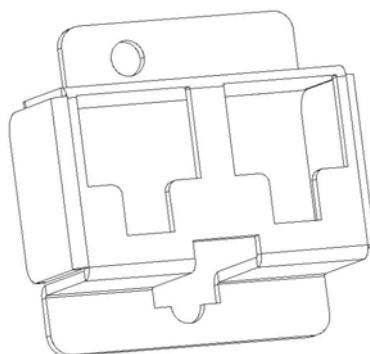

Figure 2-4

2.2 Cable Connection Sample

Please refer to Figure 2-5 for cable connection sample. Please ask your local retailer to use mobile power supply sourcing.

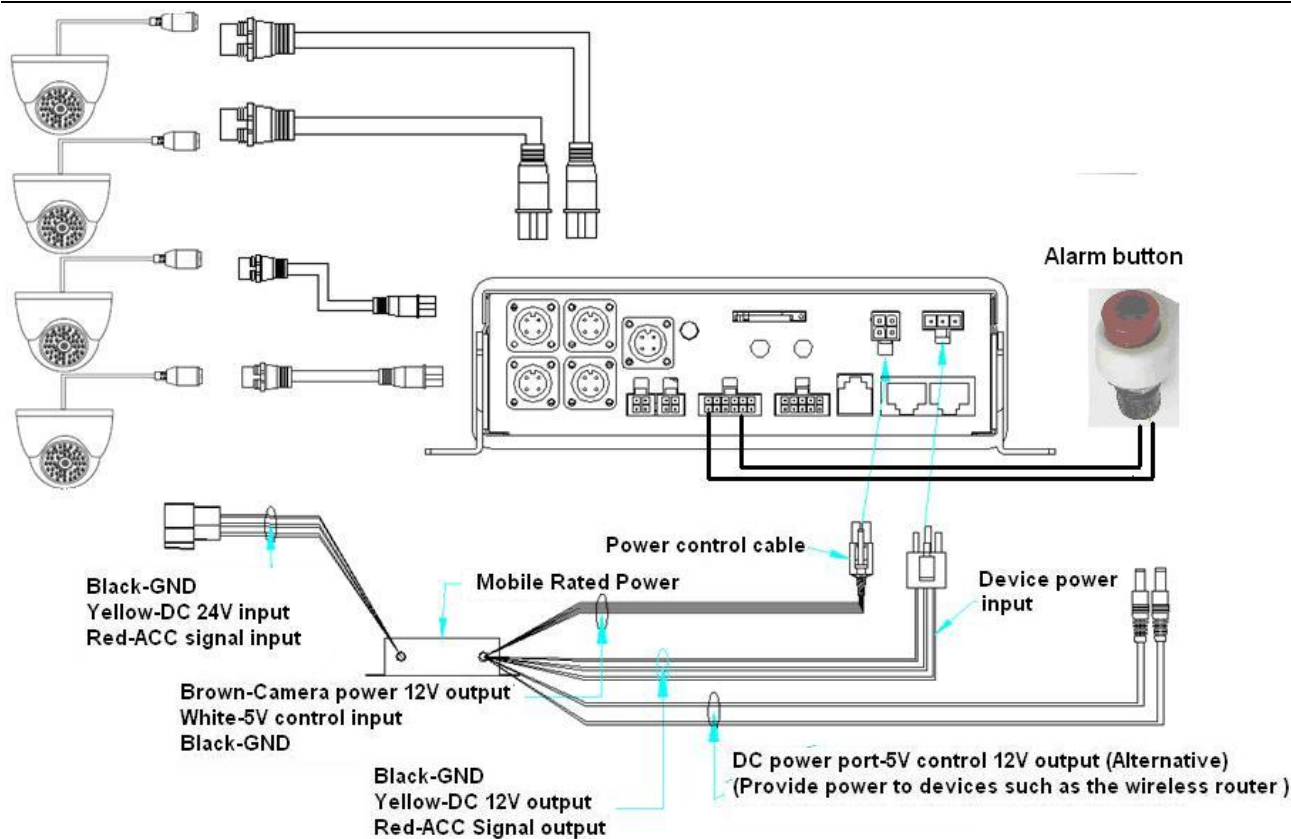

Figure 2-5

| | |
|----|-------------------------------------|
| 1 | Video input |
| 2 | Audio input |
| 3 | Video CVBS output |
| 4 | Audio output |
| 5 | Network port |
| 6 | USB port |
| 7 | HDMI port |
| 8 | RS232 port |
| 9 | Video VGA output |
| 10 | Alarm input/alarm output/RS485 port |
| 11 | Power input port |
| 12 | Power button |

Please refer to Figure 2-6 for camera power control cable information.

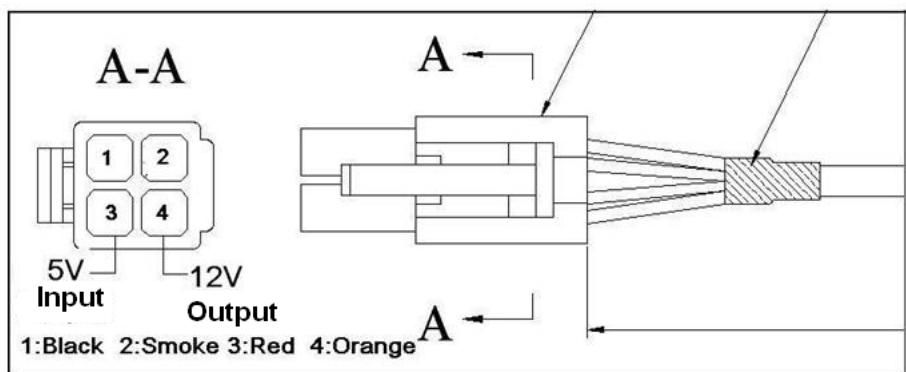

Figure 2-6

Please refer to the following sheet for detailed information.

| SOHSD Power | | | |
|-----------------------------------|-------|--|--|
| Port | SN | Cable color | Note |
| Power Input | 1 | Black | Ground cable input |
| | 2 | Red | ACC input |
| | 3 | Yellow | Normal power input |
| Power Output | 4 | Black | Ground cable output |
| | 5 | Red | ACC output |
| | 6 | Yellow | Normal power output |
| Camera power control cable output | 7 | White | 5V control input |
| | 8 | Red | 12V output (Provide power to the camera) |
| Camera Power Control Cable | | | |
| SN | Color | Note | |
| 1 | White | 5V output (Control the camera power: on/off.) | |
| 2 | Brown | 12V input | |

2.2.1 Connecting Video Output

Video output includes a BNC(PAL/NTSC BNC (1.0VP- P, 75Ω) output and a VGA output.

System supports BNC, VGA and HDMI output at the same time. See Figure 3-2

When you are using pc-type monitor to replace the monitor, please pay attention to the following points:

- To defer aging, do not allow the pc monitor to run for a long time.
- Regular demagnetization will keep device maintain proper status.
- Keep it away from strong electromagnetic interference devices.

Using TV as video output device is not a reliable substitution method. You also need to reduce the working hour and control the interference from power supply and other devices. The low quality TV may result in device damage.

Important

Please use the connection cable (not provided) when you use the VGA output.

2.3 Connecting Audio Input & Output, Bidirectional Audio

2.3.1 Audio Input

These series products adopt BNC port.

Due to high impedance of audio input, please use active sound pick-up. See Figure 2-7.

Audio transmission is similar to video transmission. Try to avoid interference, dry joint, loose contact and it shall be away from high tension current.

The 4-pin aviation-level port is shown as below. It is to input the audio and video.

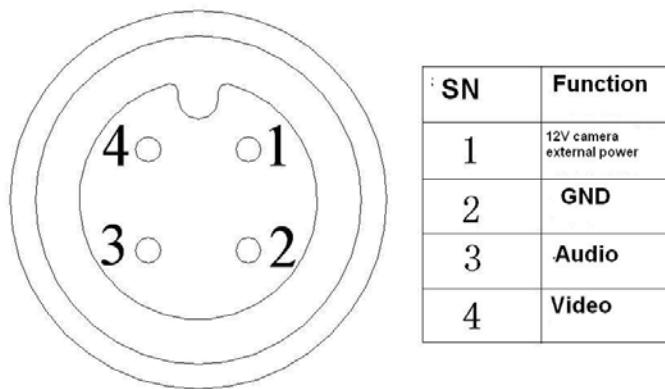

Figure 2-7

The audio/video input cable is shown as in Figure 2-8. Our default accessory is 4-pin aviation female port to male port. Please use our special aviation camera.



Figure 2-8

Please refer to the following sheet for detailed information.

| Socket | Pin | Color | Pin | Socket |
|---------------|-----|----------------|-----|-------------|
| 4P female end | 1 | Yellow (Power) | 1 | 4P male end |
| | 2 | Black(GND) | 2 | |
| | 3 | Blue(Audio) | 3 | |
| | 4 | Green(Video) | 4 | |

The audio input cable is shown as in Figure 2-9. Please use this cable when your camera is the general BNC port.

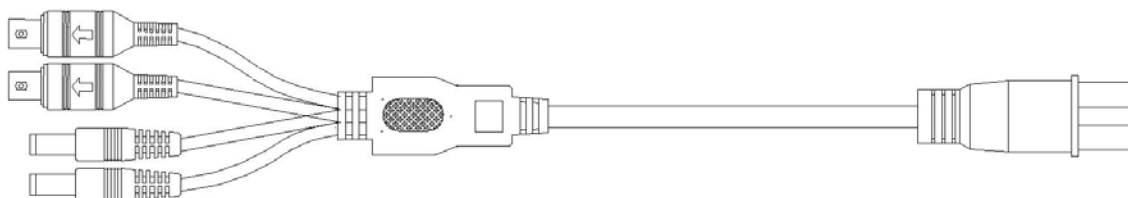

Figure 2-9

Please refer to the following sheet for detailed information.

| Audio/Video input cable (Aviation port 4p male port) | |
|--|----------------------|
| Port | Color and Definition |
| | |

| | |
|---|---|
| 1 | Yellow BNC male port (Video input) |
| 2 | White BNC male port (Audio input) |
| 3 | DC power male socket external is negative and internal is positive (Camera power output) |
| 4 | DC power male socket external is negative and internal is positive (Camera power output) |

2.3.2 Audio Output

The audio output signal parameter is usually over 200mv 1KΩ (BNC). It can directly connect to low impedance earphone, active sound box or amplifier-drive audio output device.

If the sound box and the pick-up cannot be separated spatially, it is easy to arouse squeaking. In this case you can adopt the following measures:

- Use better sound pick-up with better directing property.
- Reduce the volume of the sound box.
- Using more sound-absorbing materials in decoration can reduce voice echo and improve acoustics environment.
- Adjust the layout to reduce happening of the squeaking.

Please refer to Figure 2-10. It is for audio and video output.

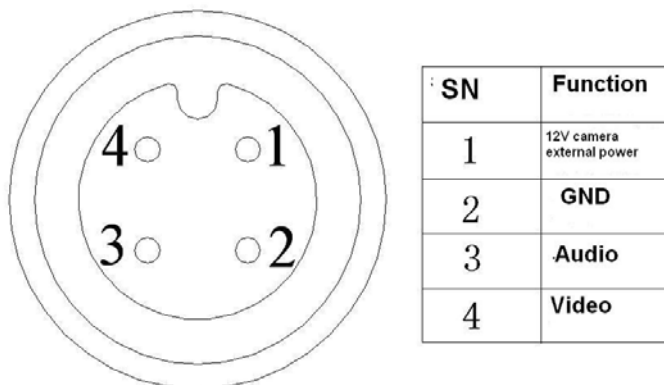

Figure 2-10

Audio/video output cable is shown as below. See Figure 2-11. You can use it when your monitor port is general BNC port.

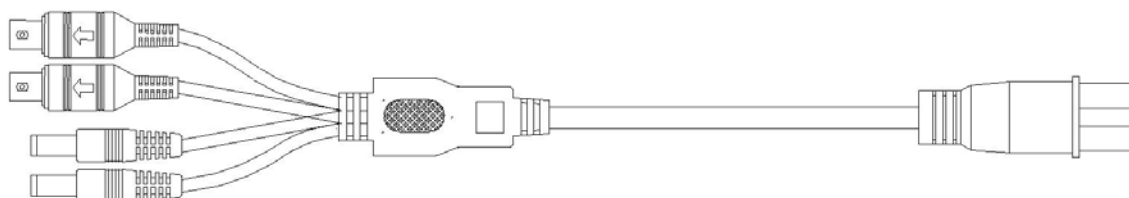

Figure 2-11

Please refer to the following sheet for detailed information.

| Audio/Video Output Cable (Aviation-level port 4p male socket) | |
|--|---|
| Socket | Color and Definition |
| 1 | Yellow BNC male port (Video input) |
| 2 | White BNC male port (Audio input) |
| 3 | DC power male socket external is negative and internal is positive (12V power output) |
| 4 | DC power male socket external is negative and internal is positive (12V power output) |

2.4 Installation Dimension

Please refer to the following figure for installation dimension information. Please note the unit is mm. See Figure 2-12.

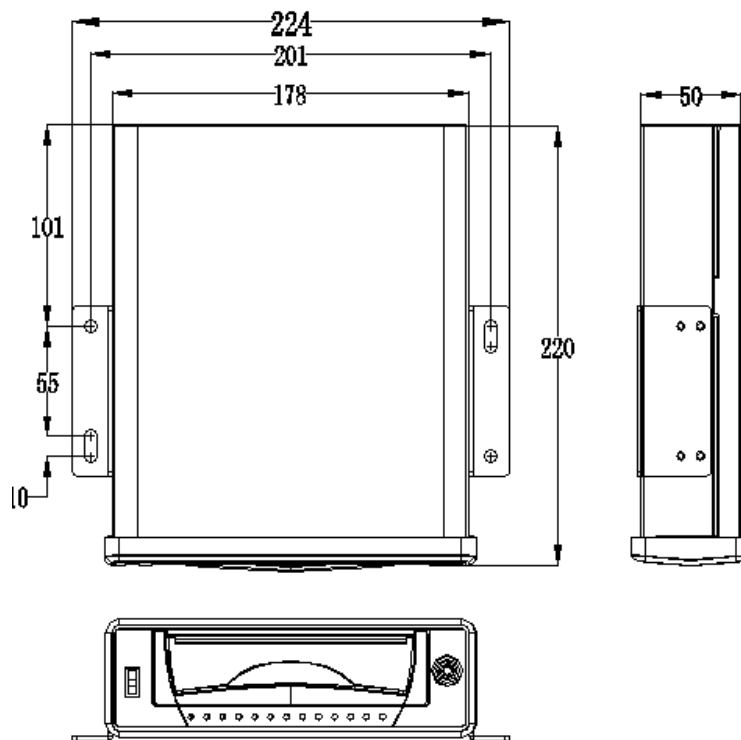

Figure 2-12

2.5 HDD Installation

The unit you received is no HDD. You need to follow the steps listed below to install.

Dismantle HDD box.

- 1) The HDD box and the parts are shown as below. See Figure 2-13. Please loosen the bolts of the HDD box and then remove the HDD box.

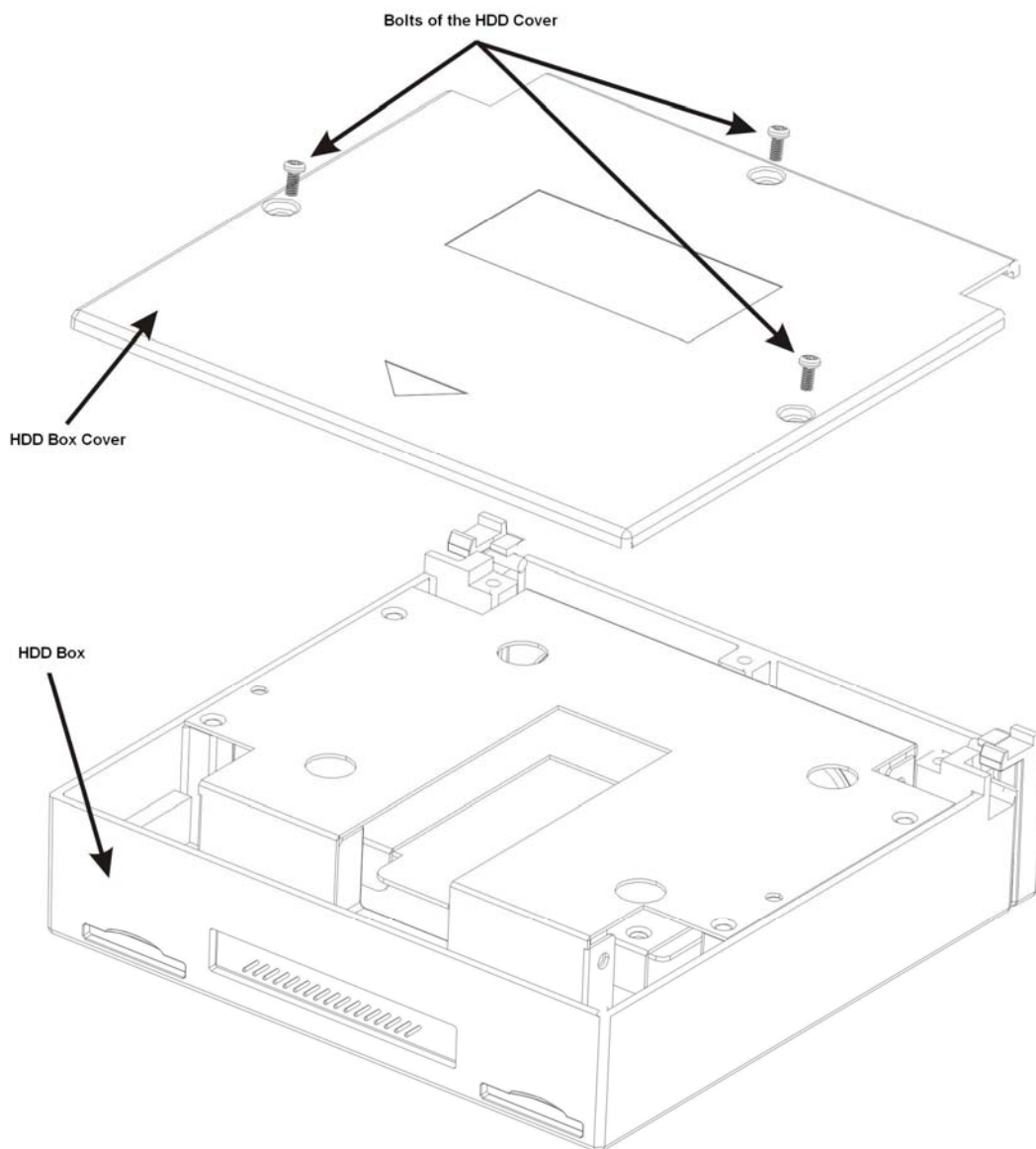

Figure 2-13

2) Now you can see an interface shown as in Figure 2-14 . Remove the four bolts from the HDD bracket and then draw out the bracket from the HDD box. Pull out the cable from the cable exit.

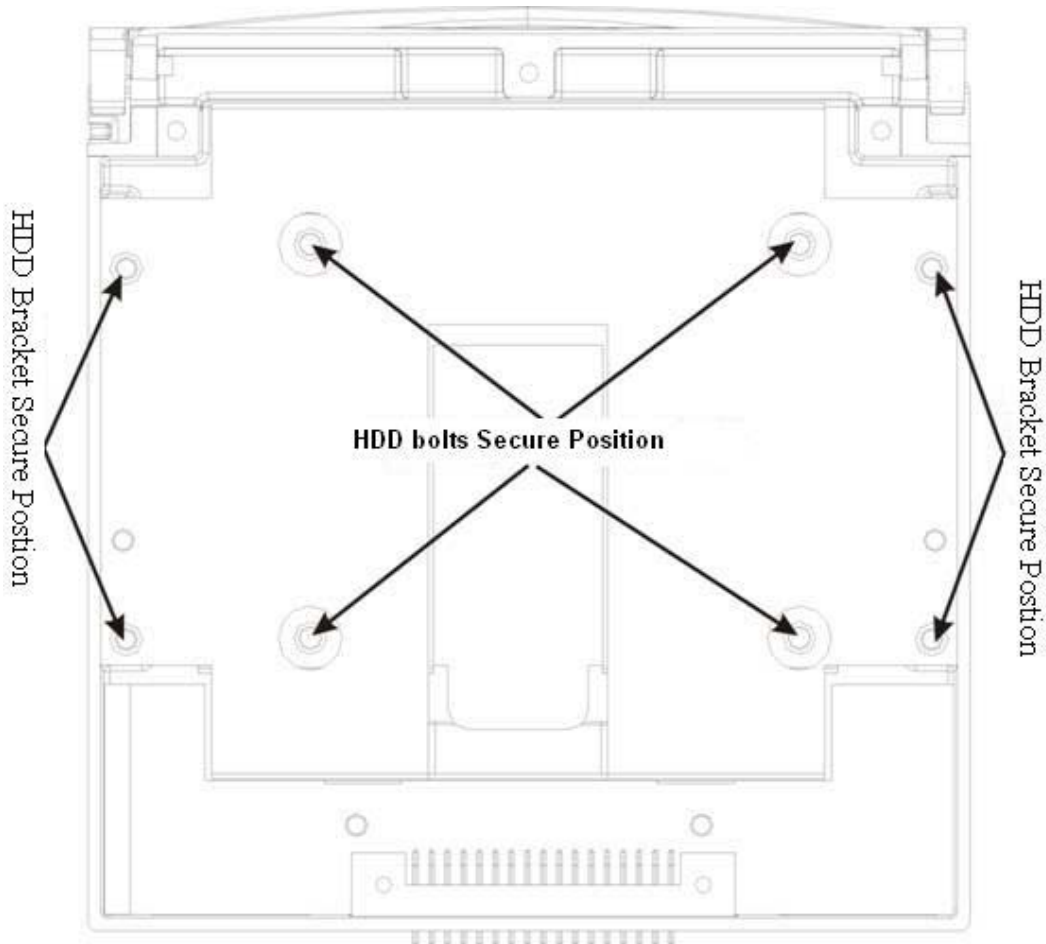

Figure 2-14

3) Now you can see an interface is shown as below after you removed the bracket. Remove the four bolts from the HDD. Follow the direction arrow in Figure 2-15 to install the HDD and secure the bolts.

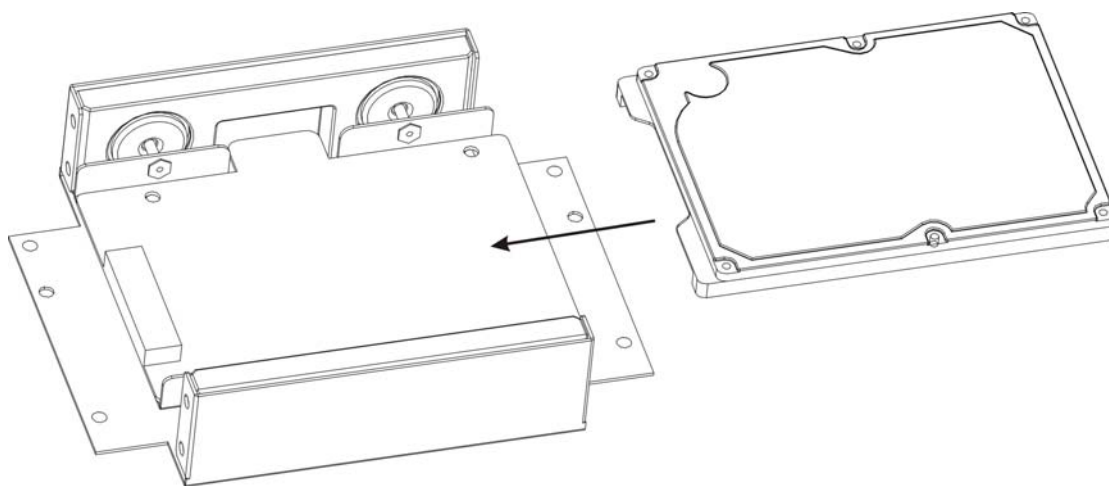

Figure 2-15

4) Now the bracket is shown as below after you fastened the HDD bolts. See Figure 2-16.

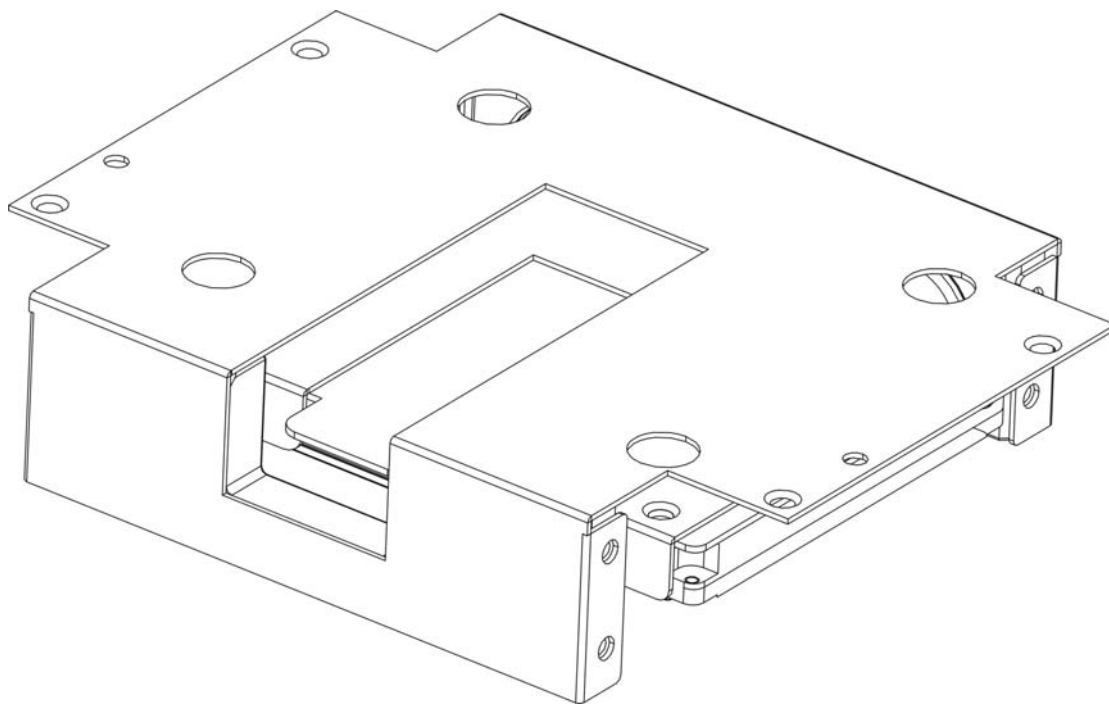

Figure 2-16

5) Install the bracket back to the HDD box and then secure the four bolts. See Figure 2-17.

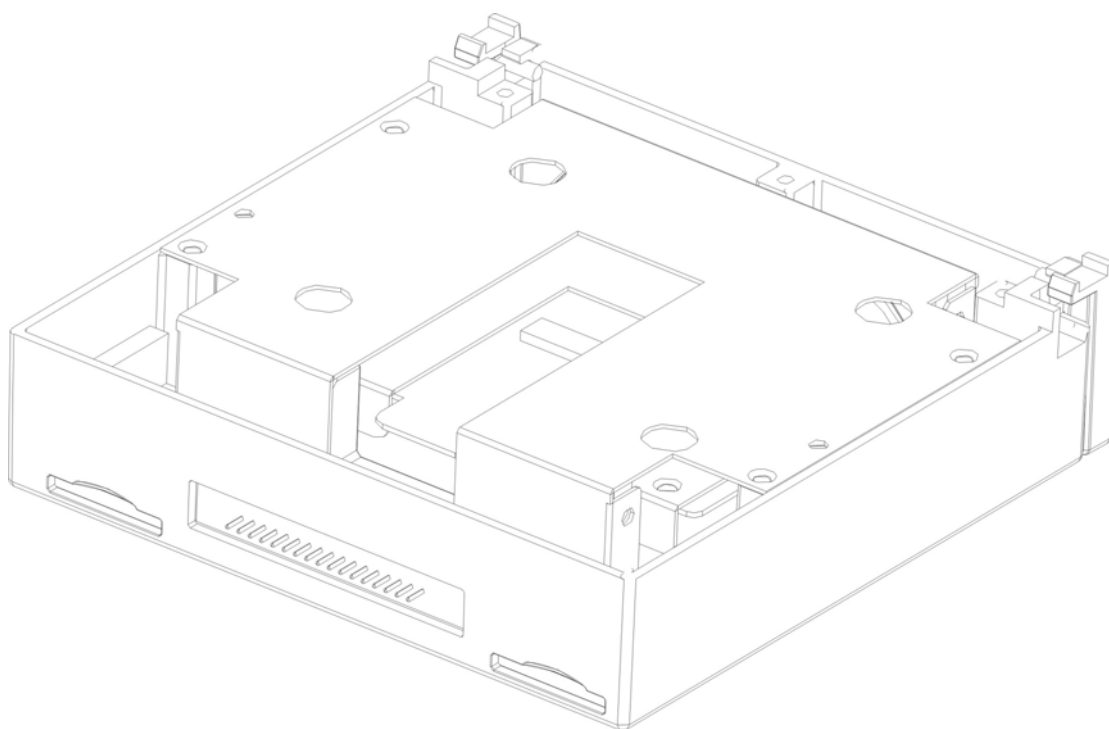

Figure 2-17

6) Put the HDD cover back and then fix the bolts firmly. Now the HDD installation completed.

2.6 Installation Position

2.6.1 Installation Position and Space

The DVR should be installed in a cool, dry place away from direct sunlight, inflammable, explosive substances and etc. At the same time, the installation position can guarantee convenient and reasonable cable layout.

Please note, you need to reserve a proper distance to draw out the HDD box.

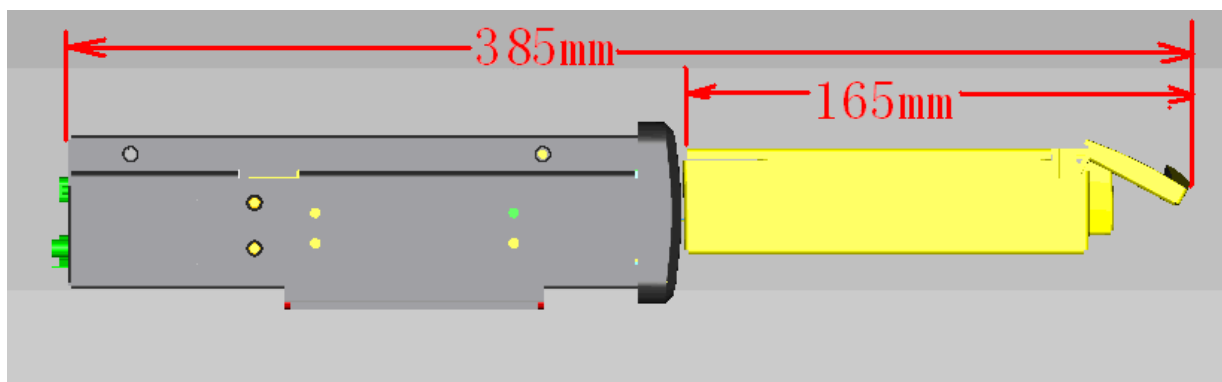

Figure 2-18

Do remember using vibration isolation rubber gasket (provided) below the device.

The recommended positions:

- For the city public bus: Use the chassis to install at the back of the driver seat.
- For the passenger transportation bus: Install at the front of the rack or in the luggage cabin.

2.6.2 Technical Requirements

There shall be a fixed installation bracket or the slide. The bracket and the slide shall be 20mm above the chassis bottom. See Figure 2-19.

It has the following advantages:

- It is easy to lay the cable, install and remove the device.
- It is easy to realize daily maintenance.
- The chassis has anti-vibration, anti-shock design and can guarantee the sound ventilation.
- It remove the risk of the human touch or trample,



Figure 2-19

2.7 Camera Installation

2.7.1 Quantity

The whole vehicle shall install five cameras and reserve one camera position. Please make sure you have reserved the corresponding cable.

2.7.2 Installation Position

The installation position can cover the whole surveillance area and there is no blind spot. See Figure 2-20.

- No.1 camera: It is at the top of the front roof to monitor the environment of the front bus.
- No.2 camera: It is at the left top of the driver seat. It can clearly view the coin-box, the whole front door and the 1 meter area of the front door.
- No.3 camera: It is at the top of the middle roof to monitor the environment of the back bus.
- No.4 camera: It is at the middle of the back door to monitor the back door status and passenger getting in/out status.
- No.5 camera: It is at the external rear end of the bus. The monitor area shall conform to your local bus specifications.
- No.6 camera: It is at the front of the roof to monitor the 5-25 meters area of the front-end. (Reserve the installation position and cable.)

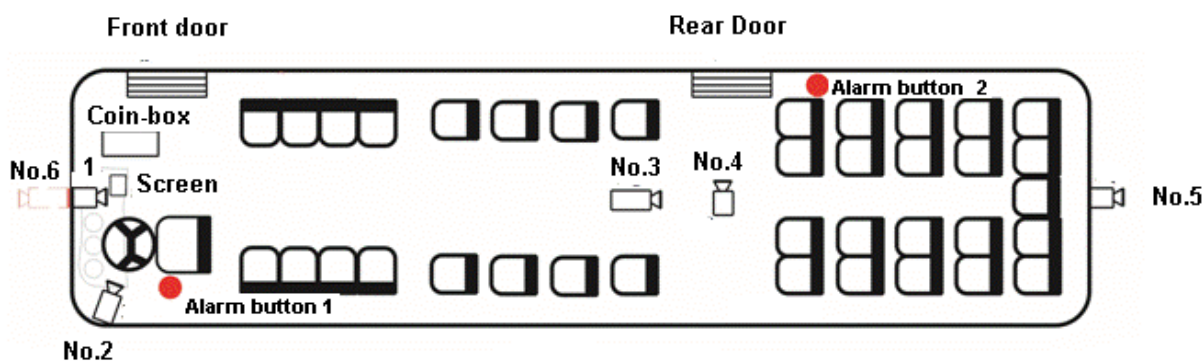

Figure 2-20

2.7.3 Installation Requirements

- There shall be the metal embedded part in vehicle and its thickness shall be more than 1mm.
- The installation position shall be stable, easy to lay the cable and suitable for daily maintenance.

2.7.4 Installation Reference Image

Please refer to the following image for the installation effect. See Figure 2-21.



Figure 2-21

2.8 The Alarm Button Chassis Installation

2.8.1 Installation Quantity

The whole bus shall install two alarm buttons.

- The No.1 alarm button shall be installed at the left top of the driver seat so that the driver can activate the alarm in case of the emergency.
- The No.2 alarm button shall be installed at the bottom of the ticket desk so that the booking clerk can activate the alarm in case of the emergency.

2.8.2 Installation Requirements

- The cable shall be hidden. The installation shall be secure and it is easy to lay the cable.
- It is easy to realize the daily maintenance and to activate the alarm. It can avoid the misuse.
- Use the negative current from the mobile connection box from the mobile socket to general the alarm button.

2.9 Cable Layout

Please use the hidden cable layout. Bundle the cable for each 50cm. Reserve 100mm at the both ends of the cable and use the cable clip to secure. Please mark the clear cable number. Use the integration video and power cable wiring harness and make sure the cable is secure.

2.10 Device Cable Connection

2.10.1 The Mobile and Camera Connection

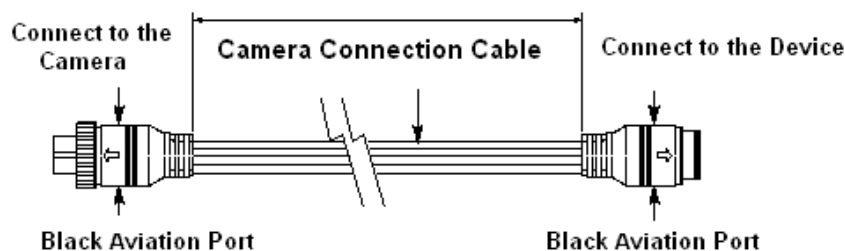

Figure 2-22

The two ends of the connection cable adopt the 4-pin aviation socket (female end). Please refer to the following sheet for detailed information.

| Port | Model | Function | Note |
|------|--|---|------------|
| 1 | 4-pin aviation connection socket (GX12-4P) | Connect to the camera | Male end |
| 2 | 4-pin aviation connection socket (GX12-4P) | Connect to the mobile DVR (Except the NO.5 camera, it uses the AV port to connect the monitor.) | Female end |

The aviation port 4-pin is shown as in Figure 2-23.

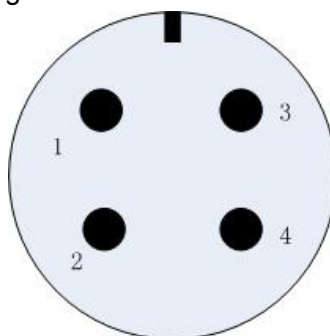

Figure 2-23

2.10.2 Device Cable

Device cable connection is an important step. Please note before cable connection, please unplug the power cable.

Please follow the steps listed below:

- Turn on the vehicle main switch and turn the key position to off.
- Use multimeter to check the vehicle power voltage.
- Search the ACC signal cable. When the key position is off, the ACC signal is 0 voltage, and when the key is on or to the ACC, the ACC signal is 24v/12v.
- Turn off the vehicle power button and turn the key to the off position.
- Make the vehicle power button.
- Make the BNC port for camera and device connection and make the camera power button.
- Connect to the device.
- Check the device cable connection.
- Plug the power cable and then debug.

3 Setup and Debug

After installation, please following processes listed below to check the device installation and electric connection and then begin system debug. The whole system needs to pass the all test and debug before it begins trial run.

Before connect to the power socket. Please check:

- The DVR power is within the normal threshold.
- The signal connection is OK.

Then you can boot up the device and begin debug.

- Check the power button, mobile DVR indication light is OK.
- GPS status and WiFi status are both OK.
- The indication light is proper after DVR boots up.
- Debug after DVR boots up normally.

3.1 Log in

Turn the key to ACC, you can see power indication light becomes on and DVR boots up (DVR boots up might take several seconds). System is in multiple-window preview mode after boots up and record setup is continuous record mode. You can see corresponding channel indication light becomes on and record indication light becomes on too.

After the system boots up, default video display is in multiple-window mode.

Click Enter or left click mouse, you can see the login interface. See Figure 3-1.

System consists of four accounts:

- Username: **admin**. Password: **admin**. (administrator, local and network)
- Username: **888888**. Password: **888888**. (administrator, local only)
- Username: **666666**. Passwords: **666666**(Lower authority user who can only monitor, playback, backup and etc.)
- Username: **default**. Password: **default**(hidden user)

For your system security, please modify you password after first login.

You can use USB mouse, front panel, remote controller or keyboard to input. About input method:

Click **123** to switch between numeral, English character (small/capitalized) and denotation.



Figure 3-1

3.2 Remote Control

The remote control interface is shown as in Figure 3-2.

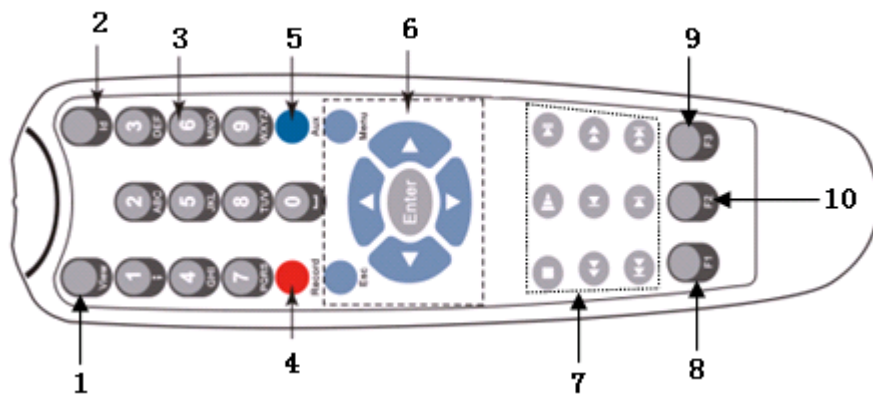



Figure 3-2

| Serial Number | Name | Function |
|---------------|---------------|---|
| 1 | View | Switch window |
| 2 | ID | Click it to input device serial number, so that you can control it. |
| 3 | Number 0 to 9 | Input password, channel or switch channel. |
| 4 | Record | Record |
| 5 | Aux | Auxiliary button |
| 6 | Enter | Confirm button |
| | Menu | Menu button |
| | Esc | Cancel button |
| | ▲ | Direction buttons |
| | ◀ ▶ | Direction buttons in PTZ. Control. |
| 7 | ■ | Stop button |
| | ◻ | Zoom out button in the PTZ control. |
| | ▶ | Slow play |
| | ▶ | Playback/pause |
| | ◻ | Zoom in button in the PTZ control |
| | ◀◀ | Backward |
| | ◀ | Previous |
| | ▶▶ | Forward |
| | ◀◀ | Various slow play speed and normal speed play. |
| | ◻ | Focus (-) button in the PTZ control. |
| ▶ | Next | |

| | | |
|----|----|---|
| | ▶▶ | Various fats play speeds and normal play speed. Focus (+) button in the PTZ control. |
| 8 | F1 | Shortcut button to backup |
| 9 | F2 | Reserved for future use. |
| 10 | F3 | Reserved for future use. |

3.3 Mouse

| | |
|---|---|
| Left click mouse | System pops up password input dialogue box if you have not logged in. In real-time monitor mode, you can go to the main menu. |
| | When you have selected one menu item, left click mouse to view menu content. |
| | Implement the control operation. |
| | Modify checkbox or motion detection status. |
| | Click combo box to pop up drop down list |
| | In input box, you can select input methods. Left click the corresponding button on the panel you can input numeral/English character (small/capitalized). Here ← stands for backspace button. _ stands for space button. In English input mode: _stands for input a backspace icon and ← stands for deleting the previous character. |
|  | |
| In numeral input mode: _ stands for clear and ← stands for deleting the previous numeral. | |
| When input special sign, you can click corresponding numeral in the front panel to input. For example, click numeral 1 you can input"/", or you can click the numeral in the on-screen keyboard directly. | |
|  | |
| Double left click mouse | Implement special control operation such as double click one item in the file list to playback the video. |

| | |
|---------------------|--|
| | In multiple-window mode, double left click one channel to view in full-window. Double left click current video again to go back to previous multiple-window mode. |
| Right click mouse | Exit main menu and go to the preview interface. |
| | Exit current menu without saving the modification. |
| Press middle button | In numeral input box: Increase or decrease numeral value. |
| | Switch the items in the check box. |
| | Page up or page down |
| Move mouse | Select current control or move control |
| Drag mouse | Select motion detection zone |
| | Select privacy mask zone. |

3.4 Live View

After you logged in, you can see main menu interface.

Right click mouse or click the ESE button in the remote control, you can go to live view window. Left click mouse or click ENTER button in the remote control, you can go to the main menu again.





In live view window, you can see system date, time and channel name. Here you can also view longitude, latitude and vehicle speed. See Figure 3-3.



In multiple-window display mode, double click one window or click the corresponding channel number in the remote control, you can go to full-screen display mode. In one-window display, double click the vide window or click the multiple-channel preview button in the remote control you can go back to multiple-window display mode.



Longitude/latitude and vehicle speed

Figure 3-3

| | | | | | |
|---|---|------------------|---|---|-------------|
| 1 |  | Recording status | 3 |  | Video loss |
| 2 |  | Motion detection | 4 |  | Camera lock |
| 5 | LON | longitude | 6 | LAN | Latitude |
| 7 | SOG | Vehicle speed | | | |

Note: Please refer to the following sheet for channel status.  stands for opening switch function,  stands for closing switch function.

3.5 Menu Operation

After you logged in, the system main menu is shown as below. See Figure 3-4. There are total six icons: search, information, setting, backup, advanced and shutdown. Move the cursor to highlight the icon, then left click mouse to enter the sub-menu.

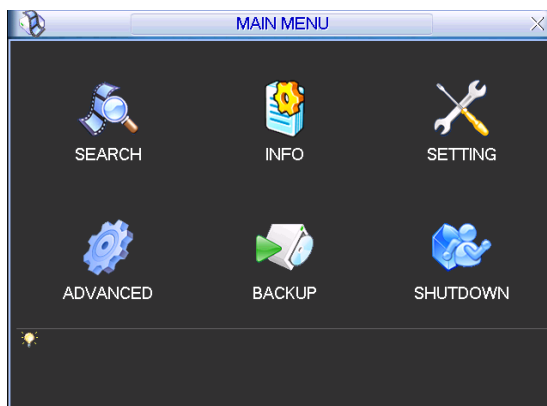

Figure 3-4

3.6 General Setup (Plate Setup)

General setup interface is shown as in Figure 3-5.

- System time: here is for you to set system time
- DVR No: when you are using one remote control to control several DVRs, you can give a name to each DVR for your management. Here you can input vehicle plate number so that you can distinguish the recorded video from various devices.

Note:

- Since system time is very important, do not modify time casually unless there is a must!
- After completed all the setups please click save button, system goes back to the previous menu.

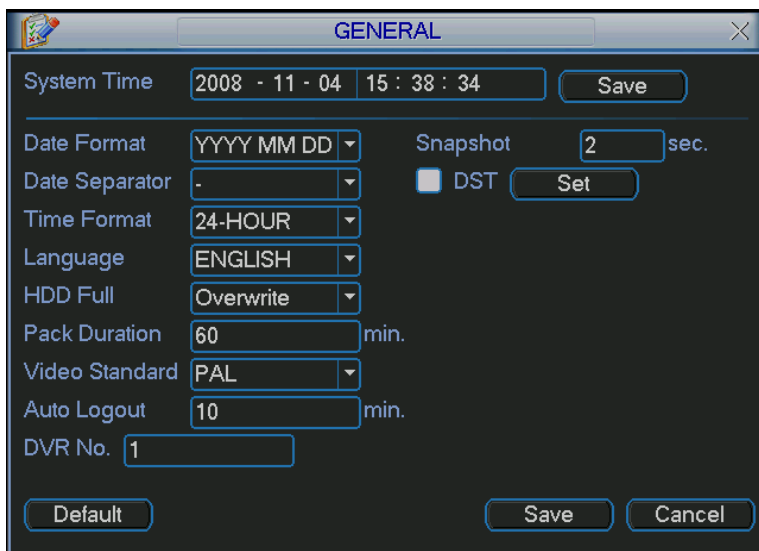

Figure 3-5

3.7 Auto Maintenance

Here you can set auto-reboot time and auto-delete old files setup. See Figure 3-6.

You can select proper setup from dropdown list.

Acc delay value ranges from 0 to 255 (unit: minute.) Please note you need to disable auto shutdown system function if you want to enable acc delay.

After completed all the setups please click save button, system goes back to the previous menu.

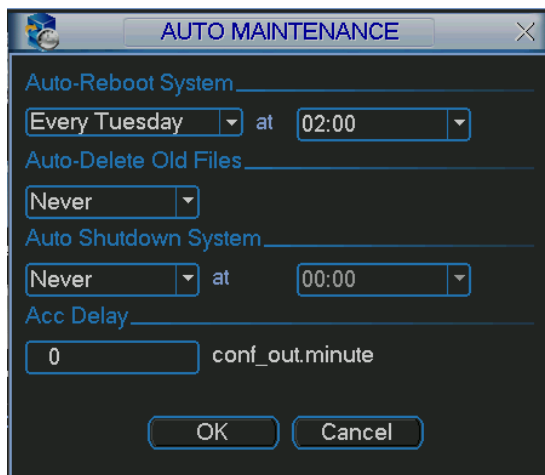

Figure 3-6

3.8 Encode

Encode setting includes the following items. See Figure 3-7.

- Channel: Select the channel you want.
- Compression: System supports H.264.

- Resolution: System supports various resolutions, you can select from the dropdown list. For this model, main stream supports D1/CIF/QCIF. Please note the resolution may vary due to different channels. The extra stream supports QCIF/CIF.
 - Frame rate: It ranges from 1f/s to 25f/s in NTSC mode and 1f/s to 30f/s in PAL mode.
 - Bit rate type: System supports two types: CBR and VBR. In VBR mode, you can set video quality.
 - Quality: There are six levels ranging from 1 to 6. The sixth level has the highest image quality.
 - Video/audio: You can enable or disable the video/audio.
 - Overlay: Click overlay button, you can see an interface is shown in Figure 3-8. Please note the following overlay titles can not be in the same position. **Please note only the unit of GPS module supports GPS overlay function.**
 - Cover area (Privacy mask): Here is for you to set privacy mask section. You can drag you mouse to set proper section size. In one channel video, system max supports 4 zones.
 - ✧ Preview/monitor: privacy mask has two types. Preview and Monitor. Preview means the privacy mask zone can not be viewed by user when system is in preview status. Monitor means the privacy mask zone can not be view by the user when system is in monitor status.
 - ✧ Time display: You can select system displays time or not when you playback.
 - ✧ Channel display: You can select system displays channel number or not when you playback.
 - ✧ Car No. display: You can select system displays car number or not when you playback.
 - ✧ GPS display: You can select system displays latitude and longitude or not when you playback.
- You need to enable the corresponding function and then click set button to set the specified position to display the information.

Please highlight icon  to select the corresponding function.

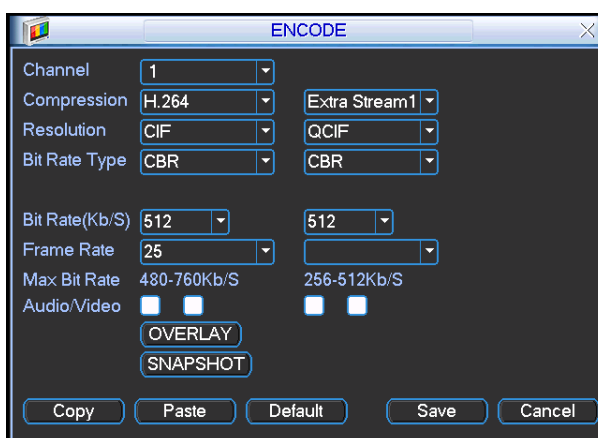

Figure 3-7

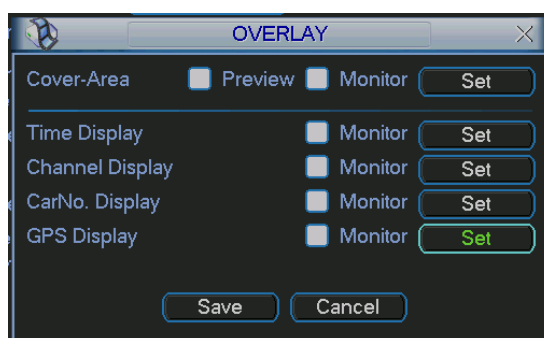

Figure 3-8

3.9 Search

There are two ways for you to go to search menu.

- Click Pause/Play button in the remote control.
- Click search in the main menu.

Search interface is shown as below. See Figure 3-9.

Usually there are three file types:

- R: regular recording file.
- A: external alarm recording file.
- M: motion detection recording file

There are several playback windows. This System supports 1-ch playback.

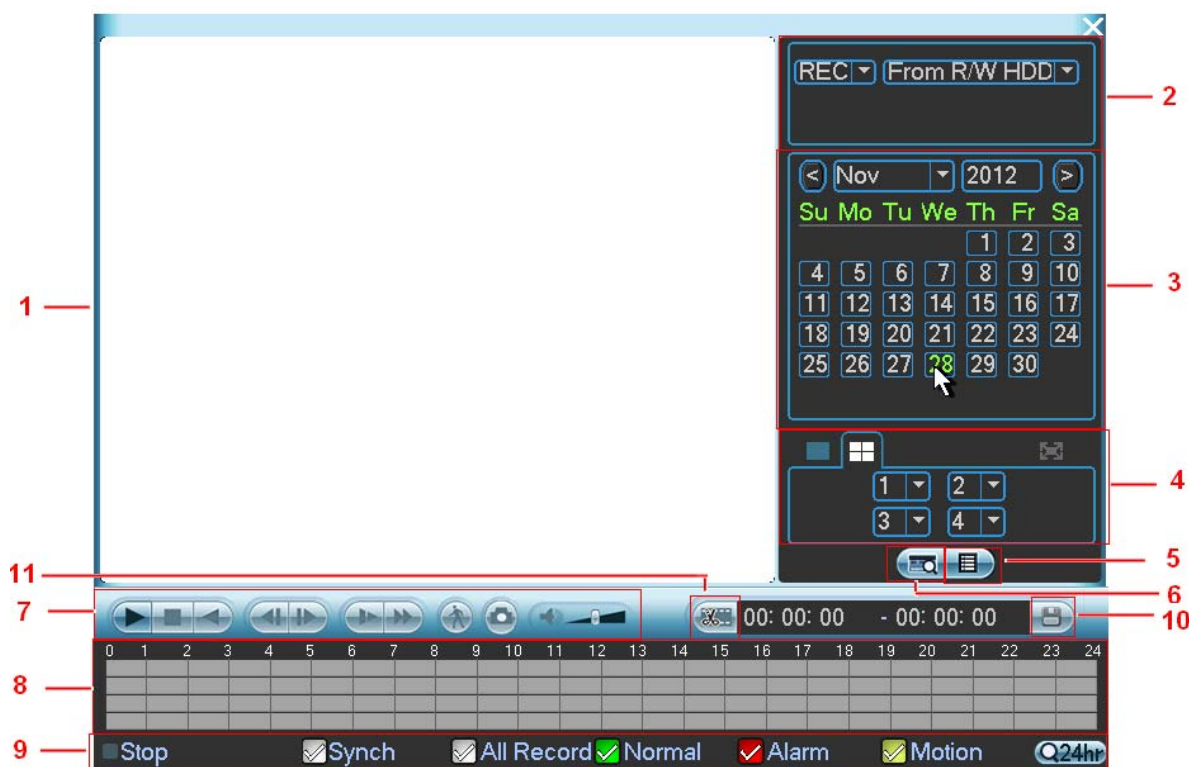

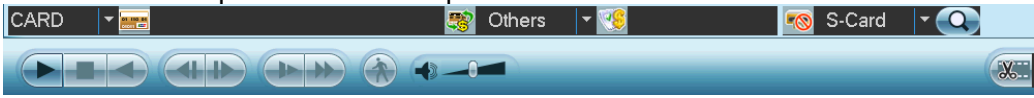











Figure 3-9

Please refer to the following sheet for more information.

| SN | Name | Function |
|----|-------------------|---|
| 1 | Display window | <ul style="list-style-type: none"> ●Here is to display the searched picture or file. ●Support 1/4-window playback. |
| 2 | Search type | <ul style="list-style-type: none"> ●Here you can select to search the picture or the recorded file. ●You can select to play from the read-write HDD or the connected external device. |
| 3 | Calendar | <ul style="list-style-type: none"> ●The blue highlighted date means there is picture or file. Otherwise, there is no picture or file. ●In any play mode, click the date you want to see, you can see the corresponding record file trace in the time bar. |
| 4 | Playback mode and | <ul style="list-style-type: none"> ●Playback mode: 1/4-channel. ●The time bar will change once you modify the playback mode or the channel option. |

| | | | |
|---|-------------------------|--|--|
| | channel selection pane. | | |
| 5 | File list switch button | <ul style="list-style-type: none"> ●Double click it, you can view the picture/record file list of current day. ●The file list is to display the first channel of the record file. ●The system can display max 128 files in one time. Use the ▲/▼ or the mouse to view the file. Select one item, and then double click the mouse or click the ENTER button to playback. ●You can input the period in the following interface to begin accurate search. ●File type: R—regular record; A—external alarm record; M—Motion detect record.  | |
| 6 | Card number search | <p>The card number search interface is shown as below. Here you can view card number/field setup bar. You can implement advanced search.</p>  | |
| 7 | Playback control pane. |  <p>Play/Pause There are three ways for you to begin playback.</p> <ul style="list-style-type: none"> ● The play button ● Double click the valid period of the time bar. ● Double click the item in the file list. <p>In slow play mode, click it to switch between play/pause.</p> | |
| | |  <p>Stop</p> | |
| | |  <p>Backward play In normal play mode, left click the button, the file begins backward play. Click it again to pause current play. In backward play mode, click ► / to restore normal play.</p> | |
| | |  <p>In playback mode, click it to play the next or the previous section. You can click continuously when you are watching the files from the same channel. In normal play mode, when you pause current play, you can click ◀ and ▶ to begin frame by frame playback. In frame by frame playback mode, click ► / to restore normal playback.</p> | |
| | |  <p>Slow play In playback mode, click it to realize various slow play modes such as slow play 1, slow play 2, and etc.</p> | |
| | |  <p>Fast forward In playback mode, click to realize various fast play modes such as fast play 1, fast play 2 and etc.</p> | |
| | | Note: The actual play speed has relationship with the software version. | |
| | |  <p>Smart search</p> | |
| | |  <p>The volume of the playback</p> | |
| | |  <p>Right now, current series product does not support snapshot function.</p> | |
| 8 | Time bar | <ul style="list-style-type: none"> ●It is to display the record type and its period in current search criteria. ●In 4-window playback mode, there are corresponding four time bars. In other playback mode, there is only one time bar. ●Use the mouse to click one point of the color zone in the time bar, system begins playback. ●The time bar is beginning with 0 o'clock when you are setting the configuration. The time bar zooms in the period of the current playback time when you are | |

| | | |
|------------------------|--------------|--|
| | | playing the file. ●The green color stands for the regular record file. The red color stands for the external alarm record file. The yellow stands for the motion detect record file. |
| 9 | Record type | In any play mode, the time bar will change once you modify the search type. |
| 10 | Backup | Select the file(s) you want to backup from the file list. System max supports files from four channels. Then click the backup button, now you can see the backup menu. Click the start button to begin the backup operation. Check the file again you can cancel current selection. System max supports to display 32 files from one channel. |
| 11 | Clip | ●It is to edit the file. ●Please play the file you want to edit and then click this button when you want to edit. You can see the corresponding slide bar in the time bar of the corresponding channel. You can adjust the slide bar or input the accurate time to set the file end time. Click this button again and then save current contents in a new file. . |
| Other Functions | | |
| 12 | Digital zoom | When the system is in full-screen playback mode, left click the mouse in the screen. Drag your mouse in the screen to select a section and then left click mouse to realize digital zoom. You can right click mouse to exit. |

Note:

All the operations here (such as playback speed, channel, time and progress) have relationship with hardware version. Some series DVRs do not support some functions or playback speeds.

If the search function is OK, then you can see the whole system is running properly.

Please refer to the Mobile DVR User's Manual for network setup and PTZ setup information.

3.10 FAQ

Q: I can not boot up the mobile DVR.

A: Please check power supply is proper or not. Then check the key power is open or not (ACC signal). The device can boot up after you enabled the power.

Q: One channel video is missing in preview mode.

A: Please check corresponding channel signal input is proper or not.

Q: Device reboots frequently.

A: Please check your have installed HDD or not.

Q: Device does not delay but I have enabled key power (ACC) latch function.

A: Please check power cable and ACC signal cable connection is OK or not.

4 Appendix Mobile DVR Installation Acceptance Certificate

Here is a sheet for you reference

| Mobile DVR Installation Acceptance Certificate | | | | | | | | | | | | | | | |
|---|---|--------------------------|--|--------|-----------------------|------------|--|--------|--|--------|--|-----------------|--|--------------|--|
| Date: ___Y___M___D | | | | | | | | | | | | | | | |
| Client Name | | Manufacturer Name | | | | | | | | | | | | | |
| Initial Check | <p>First, you can check the following items:</p> <ul style="list-style-type: none"> ● Device quantity and model. ● Check the product warranty card, certificate card, user's manual. ● Device appearance and accessories bag. <p>Vehicle Supervisor Signature:</p> <p>Installation engineer signature:</p> <p>Date: ___Y___M___D</p> | | | | | | | | | | | | | | |
| Installation | <p>Then you can check the following items:</p> <ul style="list-style-type: none"> ● Camera position and its angle. ● Device installation position. ● Cable layout. <table border="1" style="width: 100%; border-collapse: collapse;"> <thead> <tr> <th style="width: 40%;">Device</th> <th style="width: 60%;">Installation Position</th> </tr> </thead> <tbody> <tr> <td>Mobile DVR</td> <td></td> </tr> <tr> <td>Camera</td> <td></td> </tr> <tr> <td>Pickup</td> <td></td> </tr> <tr> <td>Regulated Power</td> <td></td> </tr> <tr> <td>Power supply</td> <td></td> </tr> </tbody> </table> | | | Device | Installation Position | Mobile DVR | | Camera | | Pickup | | Regulated Power | | Power supply | |
| Device | Installation Position | | | | | | | | | | | | | | |
| Mobile DVR | | | | | | | | | | | | | | | |
| Camera | | | | | | | | | | | | | | | |
| Pickup | | | | | | | | | | | | | | | |
| Regulated Power | | | | | | | | | | | | | | | |
| Power supply | | | | | | | | | | | | | | | |
| Function Test | Main Function | Item | Details | Accept | | | | | | | | | | | |
| | Monitor | | 4-ch real-time monitor. When select one channel, it can reach D1 resolution. | | | | | | | | | | | | |
| | Search | | Record search and playback. It can display record type, record time , channel title and etc. | | | | | | | | | | | | |
| | User Account | | Provide different rights for different users. | | | | | | | | | | | | |

| | | | | |
|-----------|--------------------|---|--|--|
| | System Information | HDD Info | HDD connection status, HDD total capacity, free capacity, record start/end time and etc. | |
| | | BPS | Use wave to display current bit stream and its HDD use within per hour. | |
| | | Log | Display system log and can specify the log type. | |
| | | Version | Hardware specification, software version and release date. | |
| | System Setup | General | System time, record storage mode, DVR number and etc. | |
| | | Encode | Audio/video encode mode, frame rate, quality and etc. | |
| | | Record | Schedule record, external alarm record and etc. | |
| | | COM | Set COM, baud rate and etc. | |
| | | Network | Set network address, port and etc. | |
| | | Alarm | Set external alarm output and record respond parameter setup. | |
| | | Motion Detection | Set video loss parameter. | |
| | | PTZ | Set PTZ communication protocol, baud rate and etc. | |
| | Default | Select some item(s) or select all items to restore factory default setup. Please note user account does not support this function. | | |
| | Advanced | HDD management | HDD management, clear data and etc. | |
| Abnormity | | Alarm setup for no HDD, HDD error and etc. | | |

| | | | | |
|-------------------------|---|---|--|--|
| | | Auto Maintenance | Set the auto maintenance item. | |
| | | TV Adjust | Adjust the playback output video zone. | |
| | Backup | Detect | Check backup device, list the backup devices available, display name and capacity. | |
| | | Backup operation | Backup the file(s) to the device. | |
| | | Vehicle Supervisor Signature: Installation Engineer: Date: ___Y___M___D | | |
| Accept Signature | Client Authorized Representative Signature: Date: ___Y___M___D | | | |

| SN | Plate Number | Self-defined Number | Device SN | Version Number | Note |
|----|--------------|---------------------|-----------|----------------|------|
| | | | | | |
| | | | | | |
| | | | | | |
| | | | | | |

Note:

- This document is for reference only. Slight difference may be found in the user interface.
- All the designs and software here are subject to change without prior written notice.
- All trademarks and registered trademarks mentioned are the properties of their respective owners.

- **If there is any uncertainty or controversy, please refer to the final explanation of us.**
- **Please visit our website or contact your local retailer for more information.**